



Digital - in the vehicle

Familiarize yourself with the contents of the Operator's Manual directly via the vehicle's multimedia system ("Vehicle information" menu item). Start with the quick guide or broaden your knowledge with practical tips.



Vehicle document wallet

Here you can find comprehensive printed information about operating your vehicle and about services and guarantees.



2945845301

Order no. P294 0058 13 Part no. 294 584 53 01
Edition B-2024

EQE

Mercedes-Benz



EQE

Operator's Manual

Mercedes-Benz



Front passenger air bag warning

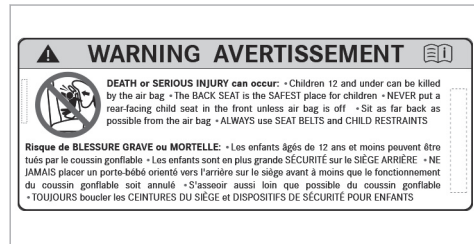
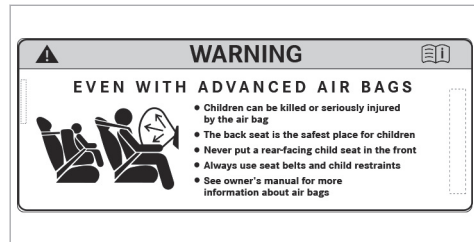

Air bag warning sticker for USA and Canada

WARNING Risk of injury or fatal injuries if the front passenger air bag is enabled

If the front passenger air bag is enabled, a child on the front passenger seat may be struck by the front passenger air bag in the event of an accident.

▶ NEVER use a rearward-facing child restraint system on a seat with an ENABLED FRONT AIR BAG. This can result in the DEATH of or SERIOUS INJURY to the CHILD.

Observe the chapter "Children in the vehicle".

Publication details

Internet

Further information about Mercedes-Benz vehicles and about Mercedes-Benz AG can be found on the following websites:

<https://www.mbusa.com> (USA only)

<https://www.mercedes-benz.ca> (Canada only)

Documentation team

©Mercedes-Benz AG: Not to be reprinted, translated or otherwise reproduced, in whole or in part, without written permission from Mercedes-Benz AG.

Vehicle manufacturer

Mercedes-Benz AG

Mercedesstraße 120

70372 Stuttgart

Germany

As at 09.06.22

Welcome to the world of Mercedes-Benz

Before your first drive, please read this Operator's Manual carefully and familiarize yourself with your vehicle. For your own safety and a longer service life of the vehicle, follow the instructions and warning notices in this Operator's Manual. Disregarding them may lead to damage to the vehicle or injury to people.

Damage to the vehicle resulting from the disregard of the instructions is not covered by the Mercedes-Benz Limited warranty.

The standard equipment and product description of your vehicle may vary and depends on the following factors:

- Model
- Order
- National version
- Availability

Your vehicle may therefore differ from that shown in the descriptions and illustrations in individual cases.

Mercedes-Benz reserves the right to introduce changes in the following areas:

- Design
- Equipment
- Technical features

The following documents are components of the vehicle:

- Digital operator's manual
- Printed Operator's Manual
- Maintenance Booklet
- Supplementary manuals relating to specific equipment
- Supplementary documents

Keep these documents in the vehicle at all times. Ensure that all documents are in the vehicle or passed on in the event of sale or rental.

Mercedes-Benz USA, LLC

Mercedes-Benz Canada, Inc.

A Mercedes-Benz Group AG Company

2945845301



Symbols	5	Service and vehicle operation	30	Seat belts	60
At a glance	6	Operating safety	31	Airbags	60
Cockpit (central display)	6	Notes on assembling the license plate on the front license plate holder	34	Safely transporting children in the vehicle	62
Cockpit (MBUX Hyperscreen)	8	National instructions for components rele- vant to radio regulation	34	Brief overview of most important points	62
Indicator and warning lamps (standard)	10	Diagnostics connection	34	Important safety notes	63
Indicator and warning lamps (with driver camera)	14	Qualified specialist workshop	36	Suitable child restraint systems for the transport of children	68
Overhead control panel	18	Correct use of the vehicle	36	Securing the child restraint system	68
Door operating unit and seat adjustment	20	Notes for persons with electronic medical aids	36	Child safety locks	74
Control settings in the rear passenger compartment	22	Problems with your vehicle	37	Occupant presence reminder	76
Emergencies and breakdowns	24	Reporting safety defects	37	Opening and closing	77
Digital Operator's Manual	26	Limited Warranty	38	SmartKey	77
Calling up the Digital Operator's Manual	26	QR code for rescue card	38	Digital Vehicle Key	81
General notes	27	Data storage	38	Doors	83
Protection of the environment	27	Copyright	43	Cargo compartment	94
Mercedes-Benz GenuineParts	27	Occupant safety	44	Side windows	100
Operator's Manual	28	Brief overview of the most important points	44	Sliding sunroof	103
Touch-sensitive controls	29	Information on the automatic functions of the restraint system	51	Anti-theft protection	107
Mercedes me app	29	Purpose and function of the restraint sys- tem	55	Seats and stowing	111
				Notes on the correct driver's seat position ..	111

Notes on grab handles	111
Seats	112
Steering wheel	120
Easy entry and exit feature	121
Memory function	123
Stowage areas	124
Cup holder	136
Sockets	141
Wireless charging of the mobile phone and connection with the exterior antenna	142
Installing and removing floor mats	143
Light and visibility	145
Exterior lighting	145
Interior lighting	154
Windshield wiper and windshield washer system	157
Mirrors	160
Area permeable to radio waves on the windshield	163
Infrared-reflective windshield function	163
Climate control	164
Overview of climate control systems	164

Operating the climate control system	167
Driving and parking	179
Driving	179
DYNAMIC SELECT	195
Transmission	198
Function of 4MATIC	200
Charge the high-voltage battery	200
Parking	217
Driving and driving safety systems	224
Trailer hitch	303
Vehicle towing instructions	307
Driver's display	309
Notes on the driver's display	309
Notes on the range	309
Notes on the 3D driver's display	310
Operating the driver's display	310
Driver display menus	311
Head-up Display	312
Overview of status displays on the driver's display	313

MBUX multimedia system	315
Overview and operation	315
System settings	332
AMG TRACK PACE	337
Drive system settings	341
Off-road menu	341
Navigation and traffic	342
Telephone	356
Mercedes me Apps	359
Mercedes-Benz emergency call system	366
Radio & media	370
Sound settings	376
Maintenance and care	377
ASSYST PLUS service interval display	377
Maintenance Management	378
Telediagnosis	378
Engine compartment	379
Filling the windshield washer system	381
Cleaning and care	381
Breakdown assistance	390
Emergency	390
Flat tire	392

4 Contents

Battery (vehicle)	398	Vehicle identification plate, VIN and engine number overview	441
Tow starting or towing away	400	Operating fluids	442
Electrical fuses	406	Vehicle data	446
		Trailer hitch	449
<hr/>			
Wheels and tires	409		
Notes on noise or unusual handling characteristics	409	Display messages and warning/indicator lamps	451
Notes on regularly inspecting wheels and tires	409	Display messages	451
Notes on snow chains	410	Warning and indicator lamps	523
Activating or deactivating snow chain mode	410		
Tire pressure	411	<hr/>	
Loading the vehicle	416	Index	540
Tire labeling	420		
Definition of terms for tires and loading	425		
Changing a wheel	427		
Emergency spare wheel	438		
<hr/>			
Technical data	439		
Notes on technical data	439		
Vehicle electronics	439		
Radio regulations	441		

In this Operator's Manual, you will find the following symbols:

⚠ WARNING Danger due to failure to observe the warning notices

Warning notices draw your attention to hazards that may endanger your health or life, or the health or life of others.

▶ Observe the warning notices.

🌿 ENVIRONMENTAL NOTE Environmental damage due to failure to observe environmental notes

Environmental notes include information on environmentally responsible behavior or environmentally responsible disposal.

▶ Observe environmental notes.

! NOTE Damage to property due to failure to observe notes on material damage

Notes on material damage inform you of risks which may lead to your vehicle being damaged.

▶ Observe notes on material damage.

ⓘ These symbols indicate useful instructions or further information that could be helpful to you.

▶ Instruction

(→ page) Further information on a topic

Display Display in the central display







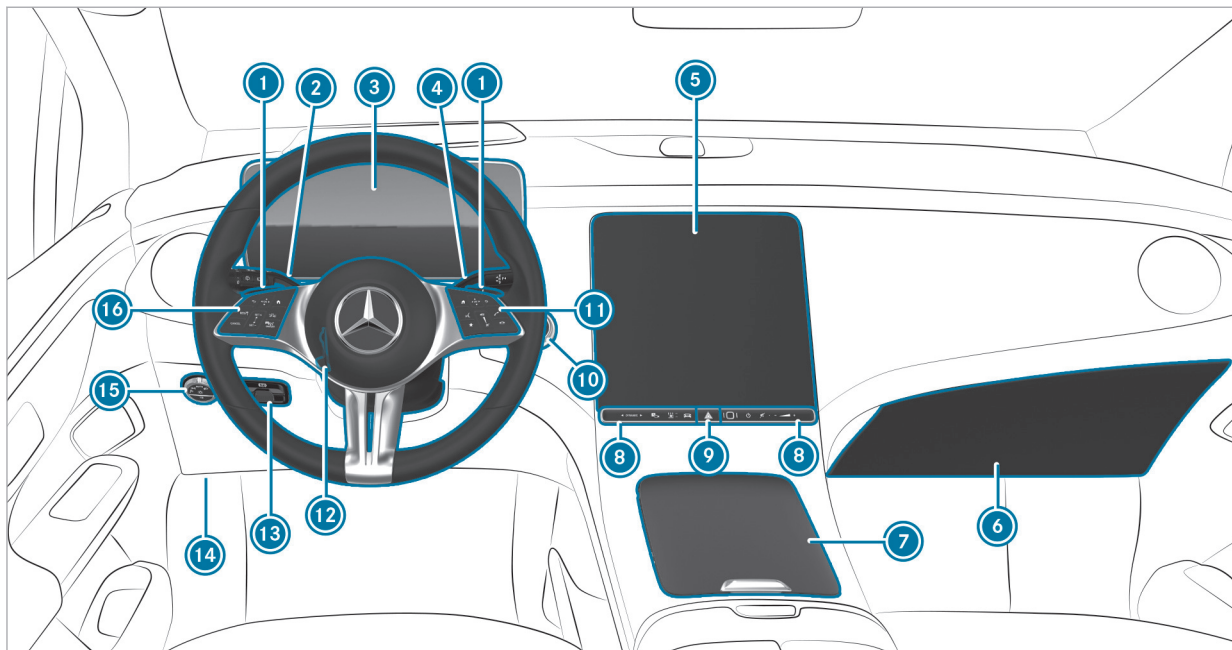





↪ Highest menu level, which is to be selected in the multimedia system

▶▶ Relevant submenus, which are to be selected in the multimedia system

* Indicates a cause



Left-hand drive vehicles (with central display)

①	 Increases recuperation	→	191				
	 Reduces recuperation	→	191				
②	Combination switch	→	146				
③	Driver's display	→	310				
④	DIRECT SELECT lever	→	198				
⑤	Central display	→	315				
⑥	Glove box	→	126				
⑦	Stowage compartment	→	126				
⑧	Switch panel for:						
	 DYNAMIC SELECT button	→	196				
	 Active Parking Assist	→	286				
	 Calls up the EQ menu	→	216				
	 Quick vehicle access						
	 Fingerprint sensor	→	315				
	 Switches the MBUX multimedia system on/off	→	315				
	 Switches sound on/off	→	315				
	 Adjusts the volume	→	315				
⑨	 Hazard warning light system	→	147				
⑩	Start/stop button	→	183				
⑪	Control panel for the MBUX multimedia system	→	323				
⑫	Adjusts the steering wheel	→	120				
⑬	 Electric parking brake	→	221				
⑭	Diagnostics connection	→	34				
⑮	Light switch	→	145				
⑯	Control panel:						
	Driver's display	→	310				
	 Active Distance Assist DISTRONIC	→	239				

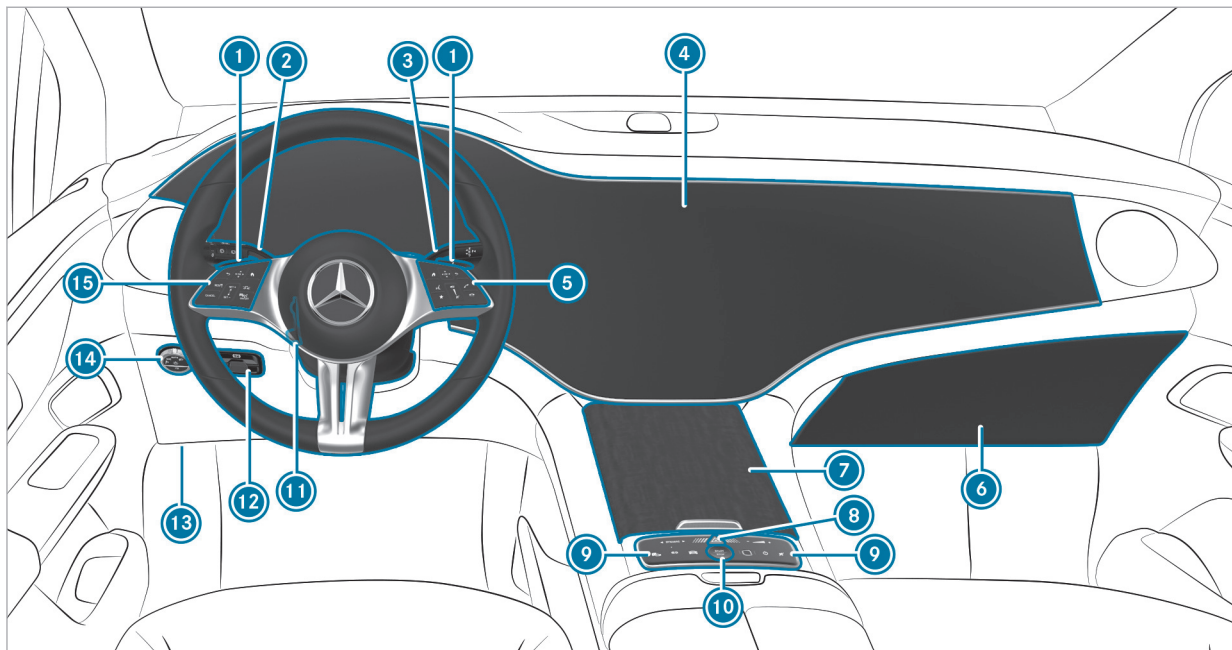







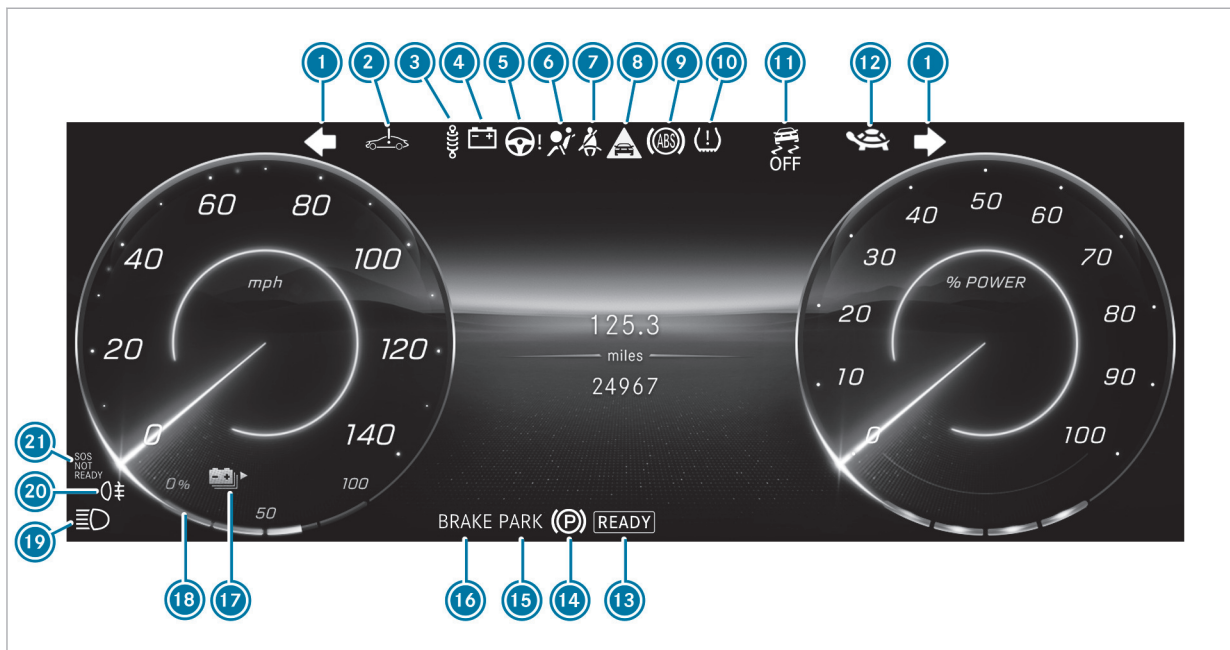

























Left-hand-drive vehicles (with MBUX hyperscreen)

①	Increases recuperation	→	191	Calls up the EQ menu	→	216	
	Reduces recuperation	→	191	Quick vehicle access			
②	Combination switch	→	146	Fingerprint sensor	→	315	
③	DIRECT SELECT lever	→	198	Switches the MBUX multimedia system on/off	→	315	
④	MBUX hyperscreen with:			Switches sound on/off	→	315	
	Driver's display	→	309	Adjusts the volume	→	315	
	Central display	→	315	⑩	Start/stop button	→	183
	Front passenger display	→	315	⑪	Adjusts the steering wheel	→	120
⑤	Control panel for the MBUX multimedia system	→	323	⑫	Electric parking brake	→	221
⑥	Glove box	→	126	⑬	Diagnostics connection	→	34
⑦	Stowage compartment	→	126	⑭	Light switch	→	145
⑧	Hazard warning lamps	→	147	⑮	Control panel:		
⑨	Switch panel for:				Driver's display	→	310
	DYNAMIC SELECT button	→	196		Active Distance Assist DISTRONIC	→	239
	Active Parking Assist	→	286				



10 At a glance - Indicator and warning lamps (standard)



Standard driver's display

1		Turn signal lights	→	146	12		Reduced power	→	527
2		System error	→	527	13		Operational readiness of drive system	→	183
3		Suspension (red)	→	533	14		Electric parking brake (yellow)	→	530
		Suspension (yellow)	→	533	15		Electric parking brake (red)	→	530
4		Electrical malfunction	→	527			USA only		
5		Power steering (red)	→	528			Canada only		
		Power steering (yellow)	→	528	16		Brakes (red)	→	530
		Rear axle steering (red)	→	528			USA only		
		Rear axle steering (yellow)	→	528			Canada only		
6		Restraint system	→	525			Recuperative Brake System, USA only	→	530
7		Seat belt	→	525			Brakes (yellow), Canada only	→	530
8		Distance warning	→	533	17		Range		
9		ABS	→	533	18		Charge level display		
10		Tire pressure monitor	→	538	19		High beam	→	146
11		ESP® OFF	→	533			Low beam	→	145
		ESP®	→	533			Standing lights	→	145

12 At a glance - Indicator and warning lamps (standard)

  Rear fog light



146

Mercedes-Benz emergency call system









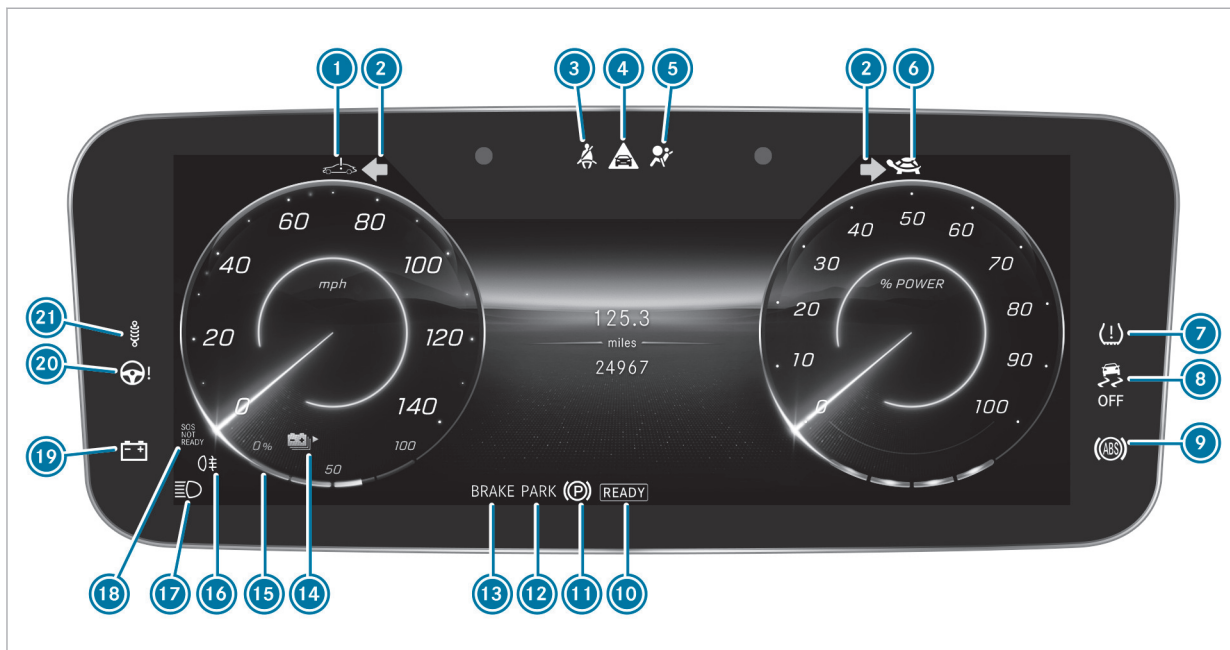

























538



14 At a glance – Indicator and warning lamps (with driver camera)



Driver's display with driver camera

1		System error	→	527			
2		Turn signal lights	→	146			
3		Seat belt	→	525			
4		Distance warning	→	533			
5		Restraint system	→	525			
6		Reduced power	→	527			
7		Tire pressure monitoring system	→	538			
8		ESP® OFF	→	533			
		ESP®	→	533			
9		ABS	→	533			
10		Operational readiness of drive system	→	183			
11		Electric parking brake (yellow)	→	530			
12		Electric parking brake (red)	→	530			
		USA only					
		Canada only					
13		Brakes (red)	→	530			
		USA only					
		Canada only					
		Recuperative Brake System, USA only	→	530			
		Brakes (yellow), Canada only	→	530			
14		Range					
15		Charge level display					
16		Rear fog light	→	146			
17		High beam	→	146			
		Low beam	→	145			
		Standing lights	→	145			
18		Mercedes-Benz emergency call system	→	538			
19		Electrical malfunction	→	527			
20		Power steering (red)	→	528			
		Power steering (yellow)	→	528			
		Rear axle steering (red)	→	528			
		Rear axle steering (yellow)	→	528			

16 At a glance - Indicator and warning lamps (with driver camera)

 Suspension (red)



533







 Suspension (yellow)

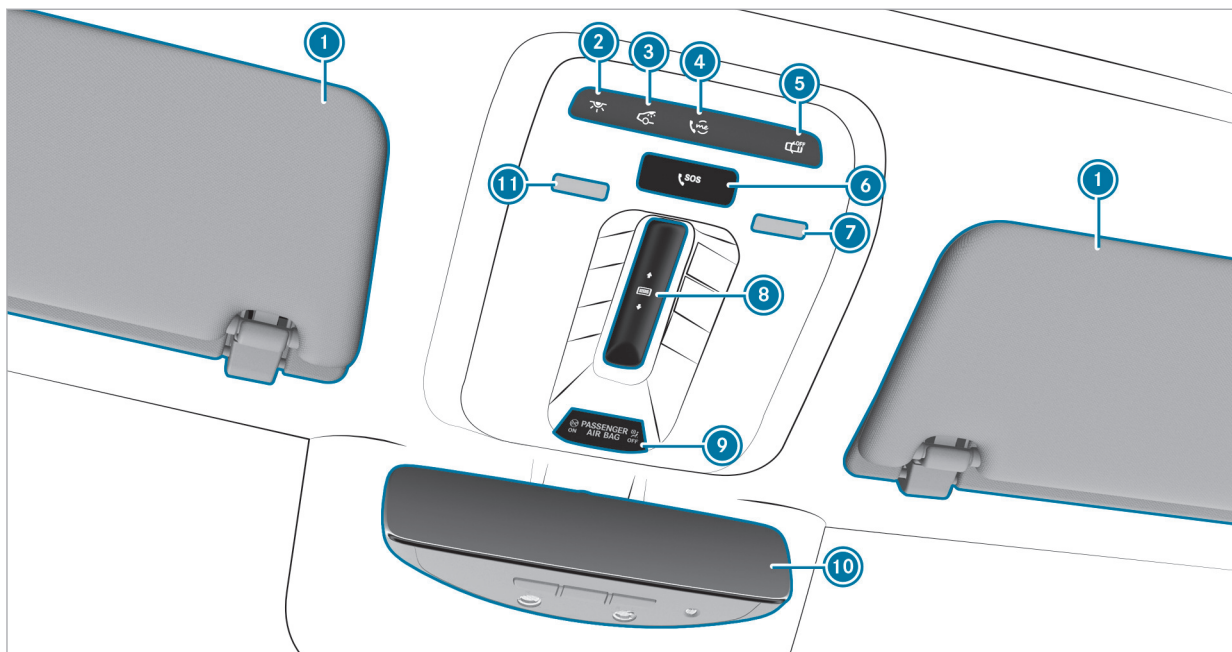







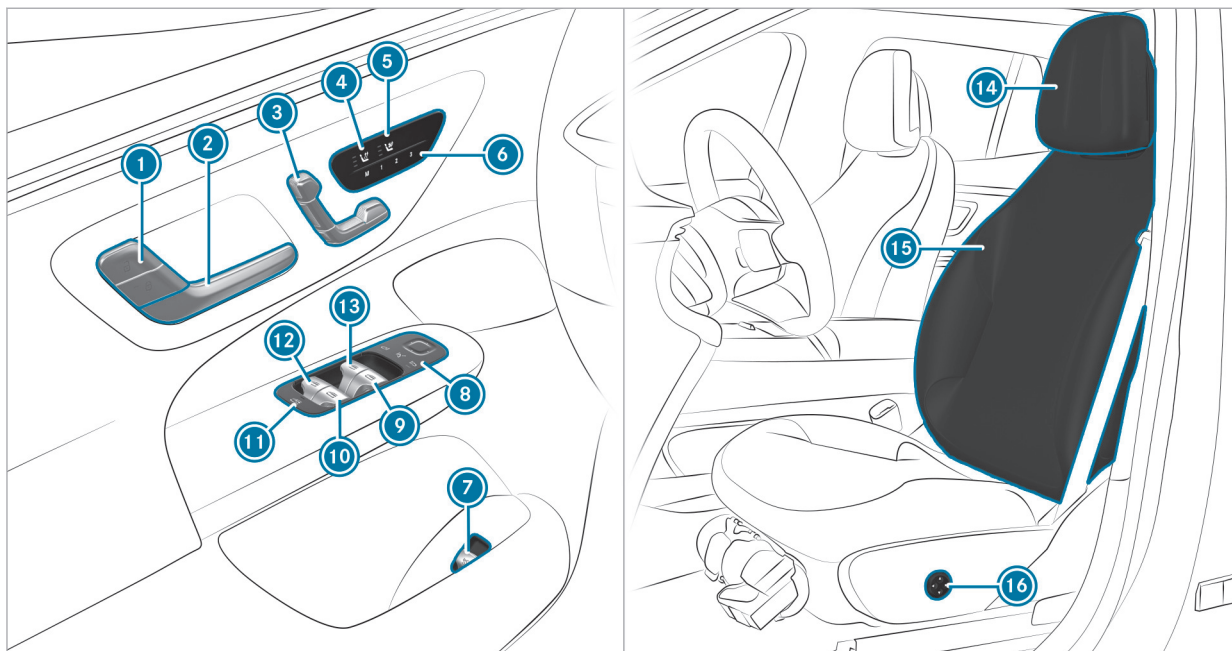

533









1	Sun visors		
2	 Switches the front interior lighting on/off	→	154
3	 Switches the rear interior lighting on/off	→	154
4	 me button	→	359
5	 Switches automatic interior lighting control on/off	→	154
6	 SOS button	→	359
7	Switches the right-hand reading lamp on/off	→	154
8	 Opens/closes the panorama roof with power tilt/sliding panel	→	103
	 Opens/closes the roller sunblind for the panorama roof with power tilt/sliding panel	→	103
9	PASSENGER AIR BAG indicator lamps	→	49
10	Inside rearview mirror	→	161
11	Switches the left-hand reading lamp on/off	→	154



1	 	Locks/unlocks the vehicle	→	84
2		Opens the door	→	83
3		Adjusts the seats electrically	→	112
4		Switches the seat heating on/off	→	118
5		Switches the seat ventilation on/off	→	119
6		Operates the memory function	→	124
7		Opens/closes the tailgate	→	94
8		Operates the outside mirrors	→	160
9		Opens/closes the right side window	→	100

10		Opens/closes the rear right side window	→	100
11		Child safety lock for the rear side windows	→	75
12		Opens/closes the rear left side window	→	100
13		Opens/closes the left side window	→	100
14		Adjusts the head restraints	→	114
15		Seat adjustment using the multimedia system	→	116
16		Adjusts the 4-way lumbar support	→	114

22 At a glance - Control settings in the rear passenger compartment

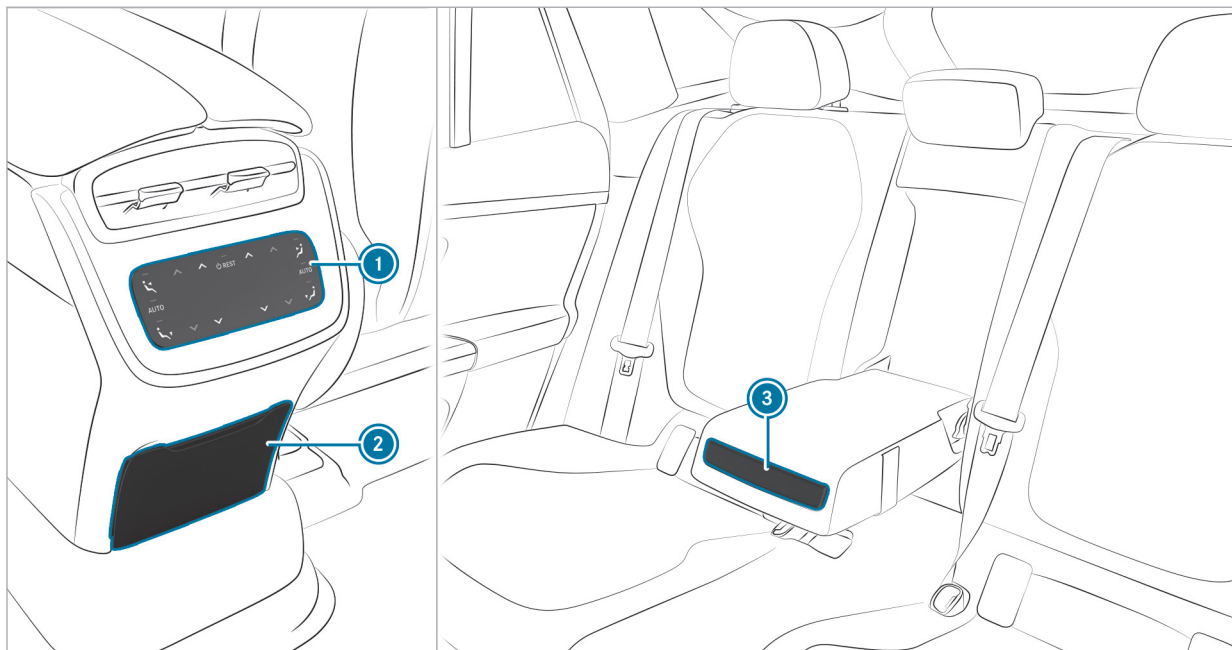



① Rear climate control operating unit → 166

② Electronics compartment in the center console

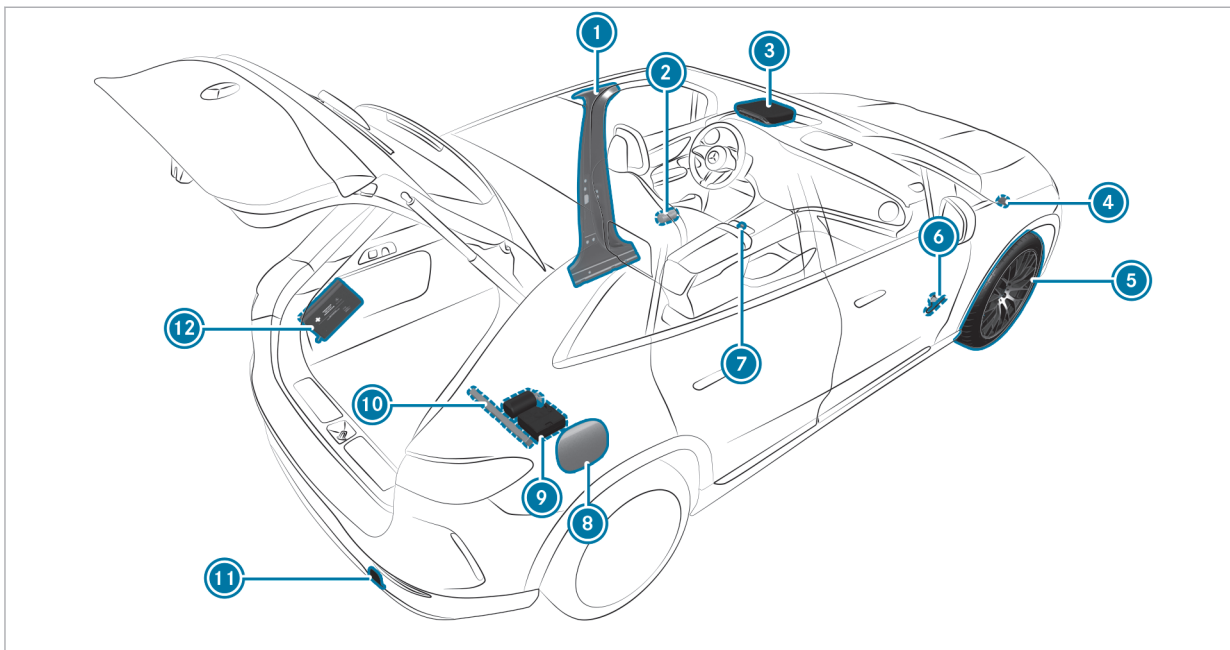
③ Cup holder → 139



① B-pillar with:			
QR code for accessing the rescue card	→	38	
Information label on tire pressure	→	412	
② Safety vests	→	390	
③  me button	→	359	
 SOS button	→	359	
④ Towing away	→	400	
⑤ Flat tire	→	392	
⑥ Operating the high-voltage disconnect device	→	180	
⑦  Hazard warning lamps	→	147	
⑧ Socket flap with:			
QR code for accessing the rescue card	→	38	
⑨ TIREFIT kit	→	394	
⑩ Warning triangle	→	391	
⑪ Towing away	→	400	
⑫ First-aid kit (soft sided)	→	391	

Calling up the Digital Operator's Manual

Multimedia system:

→ [Home] ▶ Settings ▶ Info

▶▶ Operator's Manual

▶▶ Open Digital Operator's Manual

The Digital Operator's Manual describes the functions and operation of the vehicle and the multimedia system.

▶ Select one of the following menu items in the Digital Operator's Manual:

- **Quick start:** find the first steps towards adjusting your seat (driver's side).
- **Tips:** find information that prepares you for certain everyday situations with your vehicle.
- **Animations:** watch animations about the vehicle functions.
- **Messages:** find additional information about the messages on the driver's display.
- **Language:** select the language for the Digital Operator's Manual.

You can search for keywords using the **Search** field in order to quickly find answers to questions about the operation of the vehicle.

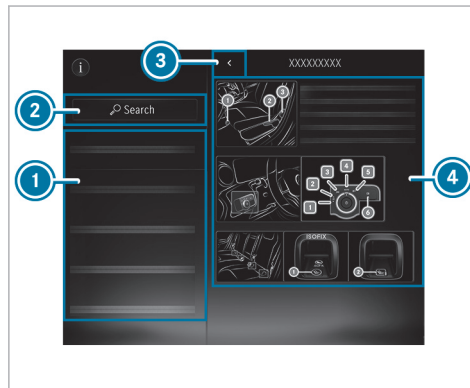

- ① Menu
- ② Search
- ③ Back
- ④ Contents section

Some sections in the Digital Operator's Manual, such as warning notes, can be expanded and collapsed.

Additional options for calling up the Digital Operator's Manual:

Driver's display: call up brief information about display messages on the driver's display

MBUX Voice Assistant: call up via the voice control system

Global search: call up search results for contents of the Digital Operator's Manual on the home screen

For safety reasons, the Digital Operator's Manual is deactivated while the vehicle is in motion.

Protection of the environment

 **ENVIRONMENTAL NOTE** Environmental damage due to operating conditions and personal driving style

Operate your vehicle in an environmentally responsible manner to help protect the environment. Please observe the following recommendations on operating conditions and personal driving style.

Operating conditions:

- ▶ Make sure that the tire pressures are correct.
- ▶ Do not carry any unnecessary weight (e.g. roof luggage racks once you no longer need them).
- ▶ Monitor energy consumption.
- ▶ Adhere to the service intervals. A regularly serviced vehicle will contribute to environmental protection.
- ▶ Always have maintenance work carried out at a qualified specialist workshop.

Personal driving style:

- ▶ Drive carefully and maintain a suitable distance from the vehicle in front.
- ▶ Avoid frequent, sudden acceleration and braking.
- ▶ Drive in a way that conserves energy. Pay attention to the ECO display for an economical driving style.

 **ENVIRONMENTAL NOTE** Environmental pollution caused by irresponsible disposal of the high-voltage battery

A high-voltage battery contains materials which are harmful to the environment.

- ▶ Dispose of defective high-voltage batteries at a qualified specialist workshop.

Environmental issues and recommendations:

It is recommended that you re-use or recycle materials instead of just disposing of them.

The relevant environmental guidelines and regulations serve to protect the environment and must be strictly observed.

Mercedes-Benz GenuineParts

 **ENVIRONMENTAL NOTE** Environmental damage due to not using recycled reconditioned components

Mercedes-Benz AG offers recycled reconditioned components and parts with the same quality as new parts. The same entitlement from the Limited Warranty is valid as for new parts.

- ▶ Use recycled reconditioned components and parts from Mercedes-Benz AG.

 **NOTE** Impairment of the operating efficiency of the restraint systems from installing accessory parts or from repairs or welding

Air bags and Emergency Tensioning Devices, as well as control units and sensors for the restraint systems, may be installed in the following areas of your vehicle:

- doors

- door pillars
- sill
- seats
- cockpit
- driver's display
- center console
- lateral roof frame

- ▶ Do not install accessory parts such as audio systems in these areas.
- ▶ Do not carry out repairs or welding.
- ▶ Have accessories retrofitted at a qualified specialist workshop.

You could jeopardize the operating safety of your vehicle if you use parts, tires and wheels as well as accessories relevant to safety that have not been approved by Mercedes-Benz. Safety-critical systems (e.g. the brake system) may malfunction. Use only Mercedes-Benz GenuineParts or parts of equal quality. Use only tires, wheels and accessory parts that have been specifically approved for your vehicle model.

Mercedes-Benz GenuineParts are subject to strict quality inspections. Each part has been specially developed, manufactured or selected for Mercedes-Benz vehicles and adapted to them. Therefore, only Mercedes-Benz GenuineParts should be used.

More than 300,000 different Mercedes-Benz GenuineParts are available for Mercedes-Benz models.

All authorized Mercedes-Benz Centers maintain a supply of Mercedes-Benz GenuineParts for necessary service and repair work. In addition, strategically located parts delivery centers provide for quick and reliable parts service.

Always specify the vehicle identification number (VIN) (→ page 441) when ordering Mercedes-Benz GenuineParts.

Operator's Manual

This Operator's Manual and the Digital Operator's Manual in the vehicle describe the following models and the standard and special equipment for your vehicle:

- The models and the standard and special equipment available at the time of this Operator's Manual going to press.
- The models and the standard and special equipment only available in certain countries.
- The models and the standard and special equipment, which will only be available at a later date.

Note that your vehicle may not have all features described. This is also the case for systems relevant to safety. Therefore, the equipment on your vehicle may differ from that in the descriptions and illustrations.

The original purchase agreement for your vehicle contains a list of the equipment in your vehicle at the time of delivery.

Should you have any questions concerning equipment and operation, please consult an authorized Mercedes-Benz Center.

i Please bear in mind that all the speed values stated in this Operator's Manual are approximate and are subject to a certain tolerance.

The Operator's Manual, Supplement, further supplementary documents and Maintenance Booklet are important documents and should be kept in the vehicle.

Touch-sensitive controls

In addition to conventional switches and buttons, your vehicle is equipped with touch-sensitive controls.

These are located in the following areas of your vehicle:

- Roof and door control panel
- Climate control
- Steering wheel
- MBUX multimedia system

The controls have touch-sensitive user interface surfaces. You can control these surfaces by pressing or swiping to adjust settings or to trigger functions, for example.

In the area of the touchscreen, you will also receive haptic feedback in the form of a pulse or a vibration, or the surface structure will change on the touch-sensitive user interface surface, for example.

You will receive haptic feedback in the following situations, for example:

- When pressing a button on the user interface surface
- When scrolling in a list or table
- When reaching a new area on the user interface surface, e.g. a pop-up window

When handling touch-sensitive user interface surfaces, observe the following points to avoid problems operating them:

- Do not affix stickers or similar objects to the surfaces
- Keep the surfaces protected from moisture

- Keep the surfaces free of dust and dirt (→ page 387).

Some touch-sensitive controls have a symbol and integrated indicator lamps. When operating, make sure to press on the symbol of the control.

Mercedes me app

Notes about the on-demand feature

You can also activate various functions (on-demand feature) subsequently via Mercedes me after purchasing your vehicle.

Information is available at any authorized Mercedes-Benz Service Center.

Activating on-demand feature using Mercedes me

Requirements

- The vehicle has a wireless connection.
- The vehicle is linked to the Mercedes me user account.

Ordering and activating on-demand feature

- ▶ Add the desired on-demand feature for the vehicle to the shopping basket in the Mercedes me Store.
- ▶ Complete the order.
The on-demand feature is activated when operating the vehicle.

Speeding up activation

- ▶ Switch the vehicle off and lock it.
- ▶ Unlock the vehicle after about two minutes and switch on the vehicle.
The on-demand feature has been activated. For some features, a notification also appears in the vehicle's multimedia system.

If the activation was not successful, repeat the process.

Service and vehicle operation

Vehicle operation outside the USA or Canada

When you are abroad with your vehicle, observe the following points:

- service points or replacement parts may not be available immediately.

Some Mercedes-Benz models are available in Europe through our European Delivery Program. For more information, please consult an authorized Mercedes-Benz Center, or write to one of the following addresses:

in the USA:

Mercedes-Benz USA, LLC
European Delivery Department
One Mercedes-Benz Drive
Sandy Springs, GA 30328

in Canada:

Mercedes-Benz Canada, Inc.
European Delivery Department
98 Vanderhoof Avenue
Toronto, Ontario M4G 4C9

Maintenance

Your customer advisor confirms the service in the service report.

Roadside Assistance

The Mercedes-Benz Roadside Assistance Program offers technical help in the case of a breakdown. Your calls to the toll-free Roadside Assistance Hotline are answered by our agents 24 hours a day, 365 days a year.

1-800-FOR-MERCEdes (1-800-367-6372) (USA)
1-800-387-0100 (Canada)

You can find further information in the Mercedes-Benz Roadside Assistance Program brochure (USA) or the "Roadside Assistance" section in the Service and Warranty booklet (Canada). You will find both in the vehicle document wallet.

Change of address or change of ownership

In the event of a change of address, please send us the "Notification of address change" in the Service and Guarantee booklet or simply call the

Mercedes-Benz Customer Assistance Center (USA) on the hotline number 1-800-FOR-MERcedes (1-800-367-6372) or Customer Service (Canada) on 1-800-387-0100. We can then reach you in a timely fashion, if necessary.

If you sell your Mercedes, please leave all literature in the vehicle so that it is available to the next owner. If you have purchased a used vehicle, please send us the "Notice of Purchase of Used Car" in the Service and Guarantee booklet or simply call the Mercedes-Benz Customer Assistance Center (USA) at the hotline number 1-800-FOR-MERcedes (1-800-367-6372) or Customer Service (Canada) at 1-800-387-0100.

Possible danger due to substances hazardous to health

In compliance with Proposition 65 ("Prop65"), the following detachable label has been added to each vehicle sold in California:



WARNING



Operating, servicing and maintaining a passenger vehicle, pickup truck, van or off-road motor vehicle can expose you to chemicals including engine exhaust, carbon monoxide, phthalates, and lead, which are known to the State of California to cause cancer and birth defects or other reproductive harm. To minimize exposure, avoid breathing exhaust, do not idle the engine except as necessary, service your vehicle in a well-ventilated area and wear gloves or wash your hands frequently when servicing your vehicle. For more information go to www.P65Warnings.ca.gov/passenger-vehicle

A 000 817 82 02

Operating safety



WARNING Risk of accident due to malfunctions or system failures

If you do not have the prescribed service/maintenance work or any required repairs carried out, this could result in malfunctions or system failures.

- ▶ Always have the prescribed service and maintenance work or any required repairs carried out in a qualified specialist workshop.



WARNING Risk of accident or injury due to incorrect modifications on electronic component parts

Modification of electronic components, their software or wiring could impair their function and/or the function of other networked component parts or safety-relevant systems.

This can endanger the operating safety of the vehicle.

- ▶ Never tamper with the wiring and electronic component parts or their software.
- ▶ You should have all work on electrical and electronic components carried out at a qualified specialist workshop.

Observe the "On-board electronics" section in "Technical data".

! **NOTE** Impairment of the operating efficiency of the vehicle or individual components due to tampering with the on-board electronics

The vehicle is equipped by the manufacturer with various safety mechanisms that interact with each other.

If the system detects tampering with the on-board electronics due to an unauthorized modification of control units and/or their software/data, this may have the following effects:

- Individual vehicle functions are (temporarily) no longer operational.
- The overall vehicle is (temporarily) no longer operational.

▶ Have the vehicle checked immediately at a qualified specialist workshop and, if necessary, reset to factory settings.

! **NOTE** Damage to the vehicle caused by driving too fast and by blows to the underbody and chassis parts

The vehicle can be damaged in the following cases in particular:

- The underside of the vehicle makes contact with the ground, e.g. on a high curb or an unpaved road.
- The vehicle drives too quickly over an obstacle, e.g. a curb, a speed bump or a pothole.
- A heavy object hits the underbody or chassis components.

In these or similar situations, the vehicle body, the underbody, chassis components, wheels or tires and parts of the high-voltage battery could be damaged even if this is not visible. Components that have been damaged in this way can fail unexpectedly or, in the event of an accident, may not absorb the loads that arise as intended.

▶ Have the vehicle checked and repaired immediately at a qualified specialist workshop.

or

▶ If driving safety is impaired during the rest of the journey, stop immediately paying attention to the traffic situation and notify a qualified specialist workshop.

Electric vehicles have an electric motor. The electric motor's energy supply is provided by the high-voltage on-board electrical system.

! **DANGER** Risk of death and fire due to modified and/or damaged components of the high-voltage on-board electrical system

The vehicle's high-voltage on-board electrical system is under high voltage. If you modify component parts in the vehicle's high-voltage on-board electrical system or touch damaged component parts, you may be electrocuted. In

addition, modified and/or damaged components may cause a fire.

In the event of an accident or impact to the vehicle underbody, components of the high-voltage electrical system may be damaged although the damage is not visible.

- ▶ Never make any modifications to the high-voltage on-board electrical system.
- ▶ Do not switch on or use the vehicle if its high-voltage on-board electrical system components have been modified or damaged.
- ▶ Never touch damaged components of the high-voltage on-board electrical system.
- ▶ After an accident, do not touch any components of the high-voltage on-board electrical system.
- ▶ After an accident, have the vehicle transported away.
- ▶ Have the components of the high-voltage on-board electrical system checked at a

qualified specialist workshop and replaced if necessary.

The components of the vehicle's high-voltage on-board electrical system are marked with yellow warning stickers. The cables of the high-voltage on-board electrical system are orange.

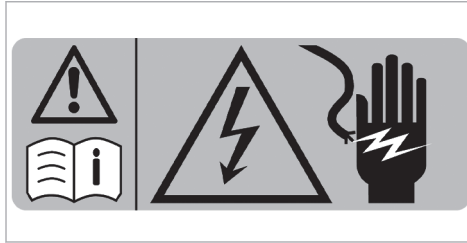

High-voltage components that can become very hot are marked with an additional warning sticker:

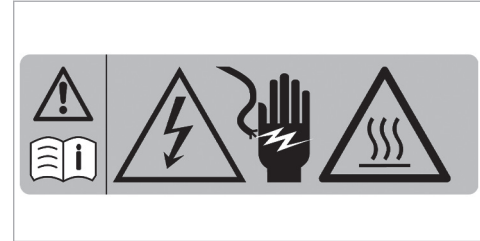

Example

Vehicles with electric motors generate significantly less noise when stationary and while driving than vehicles with internal-combustion engines.

Therefore the vehicle may not be heard by other road users due to the significantly reduced noise when stationary and while driving.

For this reason the vehicle is equipped with a sound generator, which serves as an acoustic vehicle alerting system (AVAS). This protective equipment is prescribed by law.

The outside sound produced by the sound generator (AVAS) can be heard in the passenger com-

partment at low speeds and does not represent a malfunction.

Notes on assembling the license plate on the front license plate holder

! **NOTE** Malfunctions and system failures due to incorrect mounting of the license plate on the front license plate holder

If the license plate is incorrectly mounted on the front license plate holder, sensors, cameras or driving and safety systems may malfunction or fail.

Observe the following points when mounting the license plate on the front license plate holder:

- ▶ Mount the license plate directly on the license plate holder without advertising media or other holders.
- ▶ Mount the license plate so that it does not protrude above or to the side of the license plate adapter.

National instructions for components relevant to radio regulation

Notes when crossing national borders

When operating the vehicle, you must observe the legal requirements pertaining to the use of radio devices for the country in which you are currently located.



USA: "Radio based devices of this vehicle comply with Part 15 of the FCC Rules. Operation is subject to the following two conditions: 1) These devices may not cause harmful interference, and 2) These devices must accept any interference received, including interference that may cause undesired operation. Changes or modifications not expressly approved by the party responsible for compliance could void the user's authority to operate the equipment."

Canada: "This vehicle contains licence-exempt transmitter(s)/receiver(s) that comply with Innovation, Science and Economic Development Canada's licence-exempt RSS(s). Operation is subject

to the following two conditions: (1) These devices may not cause interference. (2) These devices must accept any interference, including interference that may cause undesired operation of the devices." "Les émetteurs/récepteurs dans ce véhicule sont conformes aux CNR d'Innovation, Sciences et Développement économique Canada applicables aux appareils radio exempts de licence. L'exploitation est autorisée aux deux conditions suivantes : 1) Ces appareils ne doivent pas produire de brouillage; 2) Ces appareils doivent accepter tout brouillage radioélectrique subi, même si le brouillage est susceptible d'en compromettre le fonctionnement."

Diagnostics connection

The diagnostics connection is a technical interface in the vehicle. It is used, for example, during repair and maintenance work or for reading out vehicle data in a specialist workshop. Diagnostic devices should therefore only be connected in a qualified specialist workshop.

⚠ WARNING Risk of accident due to connecting devices to the diagnostics connection

If you connect devices to the diagnostics connection of the vehicle, the function of vehicle systems and operating safety may be impaired.

- ▶ For safety reasons, we recommend that you use and connect only products approved by an authorized Mercedes-Benz Service Center.

⚠ WARNING Risk of accident due to objects in the driver's footwell

Objects in the driver's footwell may impede pedal travel or block a depressed pedal.

This jeopardizes the operating and road safety of the vehicle.

- ▶ Stow all objects in the vehicle securely so that they cannot get into the driver's footwell.
- ▶ Always install the floor mats securely and as prescribed in order to ensure that

there is always sufficient room for the pedals.

- ▶ Do not use loose floor mats and do not place floor mats on top of one another.

⚠ NOTE Battery discharging from using devices connected to the diagnostics connection

Using devices at the diagnostics connection drains the battery.

- ▶ Check the charge level of the battery.
- ▶ If the charge level is low, charge the battery, e.g. by driving a considerable distance.

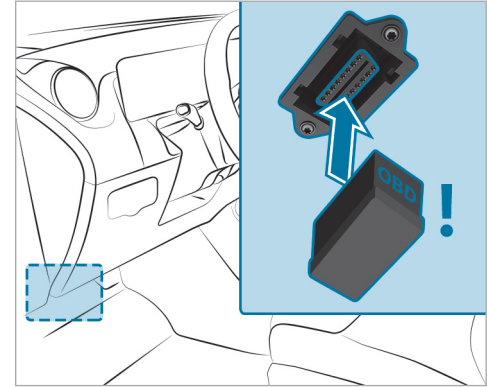

Connecting and using another device with the diagnostics connection can have the following effects:

- Malfunctions in the vehicle system
- Permanent damage to vehicle components

Please refer to the warranty terms and conditions for this matter.

Qualified specialist workshop

An authorized Mercedes-Benz Service Center is a qualified specialist workshop. It has the necessary special skills, tools and qualifications to correctly carry out the work required on your vehicle. This particularly applies to safety-relevant work.

For the following, always have your vehicle checked at an authorized Mercedes-Benz Service Center:

- Safety-relevant work
- Service and maintenance work
- Repair work
- Modifications as well as installations and conversions
- Work on electronic components

Mercedes-Benz recommends a Mercedes-Benz Service Center.

Correct use of the vehicle

If you remove any warning stickers, you or others could fail to recognize certain dangers. Leave warning stickers in position.

Observe the following information in particular when driving your vehicle:

- the safety notes in this Operator's Manual, vehicle-specific supplements and further supplementary documents
- technical data for the vehicle
- traffic laws and regulations of the country you are currently in
- laws pertaining to motor vehicles and safety standards of the country you are currently in
- radio regulatory requirements of the country you are currently in

Notes for persons with electronic medical aids

Mercedes-Benz AG cannot, despite carefully developing vehicle systems, completely rule out the interaction of vehicle systems with electronic medical aids such as cardiac pacemakers.

In addition, there are components installed in the vehicle that, regardless of the operating status of the vehicle, can generate magnetic fields on a par with permanent magnets. These fields can be found, for example, in the area around the multi-

media and sound system or also in the area of the seats, depending on the vehicle equipment.

For this reason, the following can occur in isolated cases, depending on the aids used:

- Medical aids malfunctioning
- Adverse health effects

Observe the notes and warnings of the manufacturer of the medical aids; if in doubt, contact the device manufacturer and/or your doctor. If there is continuing uncertainty concerning the possibility of medical aids malfunctioning, Mercedes-Benz AG recommends using only few electrical vehicle systems and/or maintaining a distance from the components.

When charging the high-voltage battery, keep a distance of at least an arm's length between the medical aid and the following components:

- The power supply equipment
This includes charging stations in the form of a wallbox or a public charging point, for example.
- Vehicle components carrying live voltage

This includes the charging cable and the charging control box, for example.

Only have repairs and maintenance work in the area of the following components carried out at a qualified specialist workshop:

- Vehicle components carrying live voltage
- Transmission antenna
- Multimedia system and sound system

If you have any queries or suggestions, consult a qualified specialist workshop.

Problems with your vehicle

If you should experience a problem with your vehicle, particularly one that you believe may affect its safe operation, we urge you to contact an authorized Mercedes-Benz Center immediately to have the problem diagnosed and rectified. If the problem is not resolved to your satisfaction, please discuss the problem again with an authorized Mercedes-Benz Center or, if necessary, contact us at one of the following addresses:

In the USA:

Mercedes-Benz USA, LLC
Customer Assistance Center
One Mercedes-Benz Drive
Sandy Springs, GA 30328

In Canada:

Mercedes-Benz Canada, Inc.
Customer Relations Department
98 Vanderhoof Avenue
Toronto, Ontario M4G 4C9

Reporting safety defects

USA only:

The following text is published as required of manufacturers under Title 49, Code of U.S. Federal Regulations, Part 575 pursuant to the “National Traffic and Motor Vehicle Safety Act of 1966”.

If you believe that your vehicle has a defect which could cause a crash or could cause injury or death, you should immediately inform the National Highway Traffic Safety Administration (NHTSA) in addition to notifying Mercedes-Benz USA, LLC.

If NHTSA receives similar complaints, it may open an investigation, and if it finds that a safety defect exists in a group of vehicles, it may order a recall and remedy campaign. However, NHTSA cannot become involved in individual problems between you, your dealer, or Mercedes-Benz USA, LLC.

To contact NHTSA, you may call the Vehicle Safety Hotline toll-free at 1-888-327-4236 (TTY: 1-800-424-9153) ; go to <https://www.safercar.gov>; or write to: Administrator, NHTSA, 400 Seventh Street, SW., Washington, DC 20590, USA.

You can also obtain other information about motor vehicle safety from <https://www.safercar.gov>.

Canada only:

The following text is published as required of manufacturers under subsection 18.4 (4) of the Motor Vehicle Safety Regulations.

If you believe that your vehicle has a defect which could cause a crash or could cause injury or death, you should immediately inform Transport Canada in addition to notifying Mercedes-Benz Canada Inc.

If Transport Canada received similar complaints, it may open an investigation, and if it finds that a safety defect exists in a group of vehicles, it may order a recall and remedy campaign. However, Transport Canada cannot become involved in individual problems between you, your dealer, or Mercedes-Benz Canada Inc.

To contact Transport Canada, you may call the Defect Investigations and Recalls Division toll-free in Canada at 1-800-333-0510 or 819-994-3328 in the Gatineau-Ottawa area or internationally; may also go to the following websites for more information:

- English: <https://www.tc.gc.ca/recalls>
- French: <https://www.tc.gc.ca/rappels>

Limited Warranty

! **NOTE** Damage to the vehicle arising from violation of these operating instructions.

Damage to the vehicle can arise from violation of these operating instructions.

This damage is not covered either by the Mercedes-Benz implied warranty or by the New- or Used-Vehicle Warranty.

▶ Follow the instructions in these operating instructions on proper operation of your vehicle as well as on possible vehicle damage.

QR code for rescue card

QR codes are attached in the socket flap and on the opposite side on the B-pillar. In the event of an accident, rescue services can use the QR code to quickly find the appropriate rescue card for your vehicle. The current rescue card contains the most important information about your vehicle (e.g. the routing of the electric lines) in compact form.

Further information can be obtained at <https://www.mercedes-benz.de/qr-code>

Data storage

Data processing in the vehicle

Electronic control units

Electronic control units are installed in your vehicle. Control units process data which, for example, they receive from vehicle sensors, generate themselves or exchange between themselves.

Some control units are required for the safe operation of your vehicle, some assist you when driving, such as driver assistance systems, while others enable convenience or infotainment functions.

The following provides you with general information regarding data processing in the vehicle. Additional information regarding exactly which data in your vehicle are collected, saved and transmitted to third parties, and for what purpose, can be found in the information directly related to the functional characteristics in question in their respective operating instructions. This information is also available online and, depending on the vehicle equipment, digitally.

Personal data

Every vehicle is identified by a unique vehicle identification number. Depending on the country, this vehicle identification number can be used by, for example, governmental authorities to determine the identity of the owner. There are other possibilities to use data collected from the vehicle to identify the owner or driver, such as the license plate number.

Therefore, data generated or processed by control units may be attributable to a person or, under certain conditions, become attributable to a person. Depending on which vehicle data are available, it may be possible to make inferences about, for example, your driving behavior, your location, your route or your use patterns.

Legal requirements regarding the disclosure of data

If legally required to do so, manufacturers are, in individual cases, legally obliged to provide governmental entities, upon request and to the extent required, data stored by the manufacturer. For example, this may be the case during the investigation of a criminal offense.

Governmental entities are themselves, in individual cases and within the applicable legal framework, authorized to read out data from the vehicle. In the case of an accident, information that can help with an investigation can, therefore, be taken from the air bag control unit, for example.

Operational data in the vehicle

This is data regarding the operation of the vehicle, which have been processed by control units.

This includes the following data, for example:

- vehicle status information such as the speed, longitudinal acceleration, lateral acceleration, number of wheel revolutions or the fastened seat belts display
- ambient conditions, such as temperature, rain sensor or distance sensor

Generally, the use of these data is temporary; they will not be stored beyond the period of operation and will only be processed within the vehicle itself. Control units often contain data memories for vehicle keys, for example. Their use permits the temporary or permanent documentation of technical information about the vehicle's operat-

ing state, component loads, maintenance requirements and technical events or malfunctions.

Depending on the vehicle equipment, the following data are stored:

- operating status of system components, such as fill levels, tire pressure or battery status
- malfunctions or faults in important system components, such as lights or brakes
- system reactions in special driving situations, such as air bag deployment or the intervention of stability control systems
- information on events leading to vehicle damage
- charge level of the high-voltage battery, estimated range

In certain cases, it may be required to store data that would have otherwise been used only temporarily. This may be the case if the vehicle has detected a malfunction, for example.

If you use services, such as repair services and maintenance work, stored operational data as well as the vehicle identification number can be read out and used. They can be read out by

service network employees, such as workshops and manufacturers or third parties, such as breakdown services. The same is true in the case of warranty claims and quality assurance measures.

In general, the readout is performed via the legally prescribed port for the diagnostics connection in the vehicle. The operational data that are read out document technical states of the vehicle or of individual components and assist in the diagnosis of malfunctions, compliance with warranty obligations and quality improvement. To that end, these data, in particular information about component loads, technical events, malfunctions and other faults may be transmitted along with the vehicle identification number to the manufacturer. Furthermore, the manufacturer is subject to product liability. For this reason the manufacturer also uses operational data from the vehicle, for example, for recalls. These data can also be used to examine the customer's warranty and guarantee claims.

Malfunction memories in the vehicle can be reset by a service outlet or at your request as part of repair or maintenance work.

Convenience and infotainment functions

You can store convenience settings and individual settings in the vehicle and change or reset them at any time.

Depending on the vehicle equipment, this includes the following settings, for example:

- seat and steering wheel positions
- suspension and climate control settings
- individual settings, such as interior lighting

Depending on the selected equipment, you can import data into vehicle infotainment functions yourself.

Depending on the vehicle equipment, this includes the following data, for example:

- multimedia data, such as music, films or photos for playback in an integrated multimedia system
- address book data for use in connection with an integrated hands-free system or an integrated navigation system
- entered navigation destinations
- data about the use of Internet services

These data for convenience and infotainment functions may be saved locally in the vehicle or they may be located on a device which you have connected to the vehicle, such as a smartphone, USB flash drive or MP3 player. If you have entered these data yourself, you can delete them at any time.

This data is transmitted from the vehicle to third parties only at your request. This applies, in particular, when you use online services in accordance with the settings that you have selected.

Smartphone integration (e.g. Android Auto or Apple CarPlay®)

If your vehicle is accordingly equipped, you can connect your smartphone or another mobile end device to the vehicle. You can then control them by means of the control elements integrated in the vehicle. Images and audio from the smartphone can be output via the multimedia system. Certain information is simultaneously transferred to your smartphone. Depending on the type and integration, this includes position data, day/night mode and other general vehicle statuses. For more information please consult the Operator's Manual of the vehicle/infotainment system.

This integration allows the use of selected smartphone apps, such as navigation or music player apps. There is no further interaction between the smartphone and the vehicle; in particular, vehicle data is not directly accessible. The type of additional data processing is determined by the provider of the app being used. Which settings you can make, if any, depends on the specific app and the operating system of your smartphone.

Online services

Wireless network connection

If your vehicle has a wireless network connection, it enables data to be exchanged between your vehicle and additional systems. The wireless network connection is made possible by the vehicle's own transmitter and receiver or by a mobile end device that you have brought into the vehicle, for example, a smartphone. Online functions can be used via the wireless network connection. This includes online services and applications/apps provided to you by the manufacturer or by other providers.

Manufacturer's services

Regarding the manufacturer's online services, the individual functions are described by the manufacturer in a suitable place, for example, in the Operator's Manual or on the manufacturer's website, where the relevant data protection information is also given. Personal data may be used for the provision of online services. Data is exchanged via a secure connection, such as the manufacturer's designated IT systems. Any personal data which is collected, processed and used, other than for the provision of services, is done so exclusively on the basis of legal permission. This is the case, for example, for a legally prescribed emergency call system, a contractual agreement or when consent has been given.

You can have services and functions, some of which are subject to a fee, activated or deactivated. This excludes legally prescribed functions and services, such as an emergency call system.

Third-party services

If you use online services from other providers (third parties), these services are the responsibility of the provider in question and subject to that provider's data protection conditions and terms of

use. As a general rule, the manufacturer has no influence on the content exchanged.

For this reason, when services are provided by third parties, please ask the service provider in question for information about the type, extent and purpose of the collection and use of personal data.

Data protection rights

Depending on your country or the equipment and range of functions of your vehicle as well as the services you use and the services on offer, you are entitled to different data protection rights. Further information on data protection and your data protection rights can either be found on the manufacturer's website or you will receive this information as part of the various services and service offers. There you will also find the contact information for the manufacturer and its data protection officers.

At a workshop, for example, with the support of a specialist and possibly for a fee, you can have data read out which is stored only locally in the vehicle.

MBUX multimedia system/Mercedes me connect

If the vehicle is equipped with the MBUX multimedia system or Mercedes me connect, additional data about the vehicle's operation, the use of the vehicle in certain situations, and the location of the vehicle may be compiled by the MBUX multimedia system or Mercedes me connect.

For additional information, please refer to the "MBUX multimedia system" section and/or the Mercedes me connect Terms and Conditions.

Event data recorder

USA only:

This vehicle is equipped with an event data recorder (EDR). The main purpose of an EDR is to record, in certain crash or near crash-like situations, such as an air bag deployment or hitting a road obstacle, data that will assist in understanding how a vehicle's systems performed. The EDR is designed to record data related to vehicle dynamics and safety systems for a short period of time, typically 30 seconds or less.

The EDR in this vehicle is designed to record such data as:

- How various systems in your vehicle were operating;
- Whether or not the driver and passenger safety belts were buckled/fastened;
- How far (if at all) the driver was depressing the accelerator and/or brake pedal; and,
- How fast the vehicle was traveling.

These data can help provide a better understanding of the circumstances in which crashes and injuries occur. NOTE: EDR data are recorded by your vehicle only if a non-trivial crash situation occurs; no data are recorded by the EDR under normal driving conditions and no personal data (e.g., name, gender, age, and crash location) are recorded. However, other parties, such as law enforcement could combine the EDR data with the type of personally identifying data routinely acquired during a crash investigation.

To read data recorded by an EDR, special equipment is required, and access to the vehicle or the EDR is needed. In addition to the vehicle manufacturer, other parties, such as law enforcement,

that have the special equipment, can read the information if they have access to the vehicle or the EDR.

EDR data may be used in civil and criminal matters as a tool in accident reconstruction, accident claims, and vehicle safety. Since the Crash Data Retrieval CDR tool that is used to extract data from the EDR is commercially available, Mercedes-Benz USA, LLC („MBUSA“) expressly disclaims any and all liability arising from the extraction of this information by unauthorized Mercedes-Benz personnel.

MBUSA will not share EDR data with others without the consent of the vehicle owners or, if the vehicle is leased, without the consent of the lessee. Exceptions to this representation include responses to subpoenas by law enforcement; by federal, state or local government; in connection with or arising out of litigation involving MBUSA or its subsidiaries and affiliates; or, as required by law.

Warning: The EDR is a component of the Restraint System Module. Tampering with, altering, modifying or removing the EDR component may result in

a malfunction of the Restraint System Module and other systems.

State laws or regulations regarding EDRs that conflict with federal regulation are pre\empted. This means that in the event of such conflict, the federal regulation governs. As of Dec 2016, 17 states have enacted laws relating to EDRs.

Copyright

Free and open source software

Information on licenses for free and open-source software used in your vehicle can be found on the data carrier in your vehicle document wallet and with updates on the following website:

<https://www.mercedes-benz.com/opensource>



Registered trademarks

- Bluetooth® is a registered trademark of Bluetooth SIG, Inc.
- DTS™ is a registered trademark of DTS, Inc.
- Dolby® and MLP™ are registered trademarks of DOLBY Laboratories.
- ESP® and PRE-SAFE® are registered trademarks of Mercedes-Benz Group AG.
- HomeLink® is a registered trademark of Genex Corporation.
- iPod® and iTunes® are registered trademarks of Apple Inc.
- Burmester® is a registered trademark of Burmester Audiosysteme GmbH.
- Microsoft® and Windows Media® are registered trademarks of Microsoft Corporation.
- SIRIUS® is a registered trademark of Sirius XM Radio Inc.
- HD Radio™ is a registered trademark of iBiquity Digital Corporation.
- Gracenote® is a registered trademark of Gracenote, Inc.
- ZAGAT Survey® and related brands are registered trademarks of Zagat Survey, LLC.

Brief overview of the most important points

Basic information

Make sure that the following prerequisites in particular have been met so that the components of the restraint system are able to provide the intended level of protection:

- Sit correctly (→ page 45).
- Fasten the seat belt correctly (→ page 46).
 - Function of the seat belt warning lamp  (→ page 48).
 - Function of the rear seat belt status display (→ page 49).
- The restraint system warning lamp  is not lit up after the self-test (→ page 47).
- The PASSENGER AIR BAG indicator lamps display the correct status of the front passenger air bag (→ page 49).

For clear understanding

The chapter "Occupant safety" includes information on equipment, functions and behaviors that contribute directly to safety of vehicle occupants.

The information is structured as follows:

- **The most important information in brief:** in this chapter, you are provided with an overview of the relationship between the restraint system and the correct behavior of all vehicle occupants.
- **Specific information:** in further sections of the chapter "Occupant safety", you can find specific information on the equipment and functions of the restraint system.
- **Keyword directory:** you can also find certain subjects in this Operator's Manual using the keyword directory.

Information on the following subjects, among others, are not provided in the chapter "Occupant safety":

- Children in the vehicle (→ page 62)
- Driving and driving safety systems (→ page 224)
- Stowage areas (→ page 124)

Defining generic terms clearly

In this Operator's Manual, the following generic terms are used:

- **Occupant safety:** comprises the components and system functions which help to minimize, as much as possible, the stresses on and consequences for vehicle occupants during an accident.
- **Restraint system:** comprises those components which, along with the vehicle structure, help prevent vehicle occupants from potentially coming into contact with parts of the vehicle interior. The seat belts and air bags, for example, are components of the restraint system.
- **Child restraint system:** you can find all information on this subject in the chapter "Children in the vehicle" (→ page 62).

Be diligent

For the components of the restraint system to provide the intended level of protection, it is essential that the sitting posture is correct and that the seat belt is correctly fastened.

Note that negligence when adjusting your sitting posture and fastening the seat belt may have serious consequences. Be diligent and make sure that all vehicle occupants are sitting correctly and have fastened their seat belts properly before starting every journey.

Information on the correct seat position

The seat position must be correct in order for the components of the restraint system to provide the intended level of protection.

The seat position influences both the protection provided by the seat belt and the additional protection provided by the air bag.

The correct seat position with an almost upright posture and a correctly fastened seat belt also reduce the risk posed by the air bag when it is deployed.

When choosing the seat, take note of the available space. When you are sitting with the right posture in a nearly upright position, your head should not touch the roof.

⚠ WARNING Risk of injury or death due to an incorrect seat position

If you deviate from the correct seat position, the air bag cannot provide its intended protective function.

Each vehicle occupant must make sure of the following.

- ▶ Put the seat in the correct position.
- ▶ Fasten seat belts correctly. Pregnant women must take particular care to ensure that the lap belt never lies across the abdomen.
- ▶ Observe the following information.

In order for the restraint system to provide the intended level of protection, observe the following information:

- Before starting your journey, adjust your seat correctly (→ page 111).

When doing so, make sure you are able to fasten your seat belt correctly. The shoulder belt strap must be routed forward from the seat belt outlet over the center of your shoulder.

- Keep your distance from the air bags, especially the front air bags. Set the driver's seat and front passenger seat as far back as possible while making sure the seat belt is fastened correctly.
- If persons are sitting on the rear seats, vehicle occupants should maintain a sufficient distance to the parts of the vehicle interior in front of them.
- Make sure there are no people, animals or objects between the vehicle occupants and an air bag.
- If you are the driver, observe the following information on the correct position of the driver's seat (→ page 111).

Hold the steering wheel only by the steering wheel rim. This allows the driver's air bag to fully deploy.

- Assume a nearly upright position, with your buttocks as far back as possible in the gap between the seat cushion and seat backrest.

This ensures that your back lies as flat and firmly as possible against the seat backrest.

- While driving, do not lean forward and do not lean against the door or side window. You may otherwise be in the deployment area of the air bags.
- Sit with your feet resting on the floor, if possible. Your thighs are slightly supported by the seat cushion

Do not put your feet up on the cockpit, for example. Your feet may otherwise be in the deployment area of the air bag.

- Fasten the seat belt correctly.

Notes on wearing the seat belt correctly

Always fasten your seat belt correctly before starting a journey. A seat belt can provide the best level of protection only if it is worn correctly.

⚠ WARNING Risk of injury or death due to incorrectly fastened seat belt

If the seat belt is not worn correctly, it cannot perform its intended protective function.

In addition, an incorrectly fastened seat belt can also cause injuries, for example, in the event of an accident or when braking or changing direction suddenly.

- ▶ Always ensure that all vehicle occupants have their seat belts fastened correctly and are sitting properly.

⚠ WARNING Risk of injury or death when additional restraint systems are not used for persons with a smaller stature

Persons under 5 ft (1.50 m) tall cannot wear the seat belt correctly without a suitable additional restraint system.

- ▶ Always secure persons under 5 ft (1.50 m) tall in a suitable restraint system.

Each vehicle occupant must observe the following notes in particular:

- The seat belt must not be twisted:

- The shoulder belt strap must be routed forward from the seat belt outlet over the center of your shoulder.
- The shoulder belt strap should neither touch your neck nor be routed under your arm or behind your back.
- The lap belt must be routed as low down across the hips as possible.

In addition, push the lap belt down as far as possible across your hips and pull tight with the shoulder belt strap. Never route the lap belt across your abdomen.

Pregnant women must also take particular care with this.

- The shoulder belt strap and lap belt must fit snugly against the body after being tightened.
- Avoid wearing bulky clothing, e.g. a winter coat.
- Never route the seat belt across sharp, pointed, abrasive or fragile objects.
- Only one person should use each seat belt at any one time.

- Never secure objects with a seat belt if the seat belt is also being used by one of the vehicle's occupants.

Also ensure that no objects, e.g. a cushion, are ever placed between a person and the seat.

Fastening and adjusting seat belts

If the seat belt is pulled quickly or sharply, the seat belt retractor locks. The seat belt strap cannot be pulled out any further.

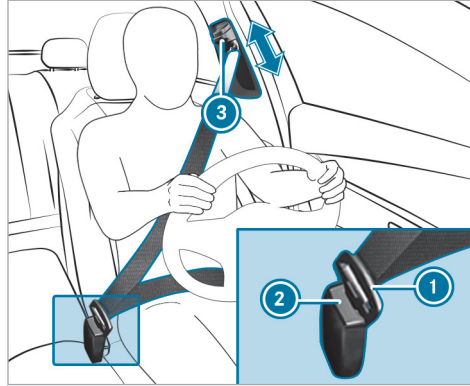

- ▶ Always engage seat belt tongue ① of the seat belt into seat belt buckle ② of the corresponding seat.
- ▶ **To adjust the seat belt height:** press button ③ on the seat belt outlet and slide the seat belt outlet to the desired position.
- ▶ **To engage the seat belt outlet:** release button ③ and ensure that the seat belt outlet engages.

! **NOTE** Deployment of components of the restraint system when the front passenger seat is unoccupied and a seat belt is buckled

When the front passenger seat is unoccupied and the seat belt tongue of the seat belt is engaged in the seat belt buckle, components of the restraint system may deploy unnecessarily on the front passenger side, e.g. the Emergency Tensioning Device.



▶ Only buckle the seat belts as intended.

i Observe the information on child seat safety feature of the seat belt (→ page 70).

Function of the restraint system warning lamp

When the vehicle is switched on, a self-test is performed, during which the restraint system warning lamp  lights up. It goes out no later than a few seconds after the vehicle is started. The components of the restraint system are then functional.

A malfunction has occurred in the restraint system if:

- the restraint system warning lamp  does not light up when the vehicle is switched on
- the restraint system warning lamp  lights up continuously or repeatedly during a journey

If components of the restraint system have been deployed, the restraint system warning lamp  lights up continuously.

⚠ WARNING Risk of injury due to malfunctions in the restraint system

Components in the restraint system may be activated unintentionally or not deploy as planned in an accident.

- ▶ Have the restraint system checked and repaired immediately at a qualified specialist workshop.

If the restraint system is malfunctioning, the automatic high voltage emergency shutoff may not function.

⚠ DANGER Risk of fatal injuries due to malfunctions of the automatic high-voltage emergency shutoff

In the event of an accident, the high-voltage on-board electrical system may not be deactivated as intended.

You may be electrocuted if you touch the damaged component parts of the high-voltage on-board electrical system.

- ▶ Have the automatic high-voltage emergency shutoff checked and repaired immediately at a qualified specialist workshop.
- ▶ After an accident, switch off the vehicle immediately.

Mercedes-Benz recommends that you have the vehicle towed to a qualified specialist workshop.

Function of the seat belt warning lamp

The  seat belt warning lamp on the driver's display is a reminder that all vehicle occupants must wear their seat belts correctly.

The  seat belt warning lamp will light up for six seconds every time the vehicle is started.

In addition, a warning tone may sound.

When the driver's and front passengers doors are closed and the driver and front passenger have fastened their seat belts, the seat belt warning will go out.

In the following cases, the seat belt warning will light up during a journey if:

- The driver or front passenger is not wearing a seat belt and the following criteria apply:
 - The vehicle travels at a speed greater than 5 mph (9 km/h) for more than 20 seconds.
 - The vehicle travels at a speed greater than 15 mph (25 km/h) once.
- The driver or front passenger unfastens his/her seat belt while the vehicle is in motion.

Function of the rear seat belt status display

The rear seat belt status display on the driver's display is a reminder that all vehicle occupants must wear their seat belts correctly.

In addition, a warning tone may sound.

If a person unfastens a seat belt in the rear passenger compartment while the vehicle is in motion, the rear seat belt status display will appear again.

Indicators on the driver's display

Every time the vehicle is switched on, the rear seat belt status display will inform you for a certain amount of time which rear seat belt is not fastened.

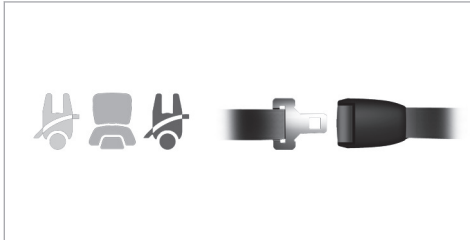

You can determine the status of the rear seat belt by the color of the seat symbol in the driver's display as follows:

- Grey: the rear seat belt is not fastened.
- Green: the seat belt tongue of a rear seat belt is engaged in the seat belt buckle of the displayed seat.
- Red: the person in the rear seat has unfastened his/her seatbelt.

Function of the PASSENGER AIR BAG indicator lamps (front passenger air bag)



The PASSENGER AIR BAG indicator lamps display the status of the front passenger air bag.

If the front passenger seat is occupied or a child restraint system is installed on the front passenger seat, you must make sure both before and also during the journey that the status of the front passenger air bag is correct for the situation.

⚠ WARNING Risk of potentially fatal injuries due to objects trapped under the front passenger seat

Objects trapped under the front passenger seat may interfere with the function of the automatic front passenger air bag shutoff or damage the system.

- ▶ Do not stow any objects under the front passenger seat.
- ▶ When the front passenger seat is occupied, ensure that no objects have become trapped beneath the front passenger seat.

Self-test: when the vehicle is switched on, both the PASSENGER AIR BAG ON and OFF indicator lamps light up simultaneously for several seconds. After the self-test, you can determine the status of the front passenger air bag as follows:

- **Front passenger air bag disabled:** PASSENGER AIR BAG OFF lights up continuously. The front passenger air bag will not be deployed in the event of an accident. If

PASSENGER AIR BAG OFF is lit, no one may use the front passenger seat.

If a rearward-facing child restraint system is installed on the front passenger seat, PASSENGER AIR BAG OFF must be lit continuously.

- **Front passenger air bag enabled:** PASSENGER AIR BAG ON lights up for up to 60 seconds or until both the PASSENGER AIR BAG ON and OFF indicator lamps go out.

The front passenger air bag may be deployed during an accident. If the front passenger air bag is in this status, no rearward-facing child restraint system may be installed on the front passenger seat.

- ① If you are driving with a child in the vehicle, observe the information in the chapter "Children in the vehicle" (→ page 62)

⚠ WARNING Risk of injury or death due to a disabled front passenger airbag

The front passenger airbag is disabled when the PASSENGER AIR BAG OFF indicator lamp is lit.

A person in the front passenger seat could then, for example, come into contact with the vehicle interior, especially if the person is sitting too close to the cockpit.

If the front passenger seat is occupied, always ensure that:

- The classification of the person in the front passenger seat is correct and the front passenger airbag is enabled or disabled in accordance with the person in the front passenger seat.
- The front passenger seat has been moved as far back as possible.
- The person is seated correctly.

- ▶ Both before and during the journey, ensure that the status of the front passenger airbag is correct.

Malfunction of the automatic front passenger air bag shutoff

The PASSENGER AIR BAG OFF indicator lamp and the  restraint system indicator lamp light up simultaneously.

In this case, no one may use the front passenger seat and no child restraint system may be installed on the front passenger seat.

Have the automatic front passenger air bag shutoff checked and repaired immediately at a qualified specialist workshop.

Be sure to also observe the following further related subjects:

- Child restraint system on the front passenger seat (→ page 66)

Disabling or enabling the front passenger air bag

The automatic front passenger air bag shutoff can activate or deactivate the front passenger air bag and knee bag according to the situation.

This will happen automatically as a result of the classification of the person or child restraint system on the front passenger seat.

You cannot manually disable or enable the front passenger air bag.

Also observe the following information:

- The status of the front passenger air bag; see "Function of the PASSENGER AIR BAG indicator lamps" (→ page 49)
- Notes on using the front passenger seat; see "Information on automatic front passenger air bag shutoff" (→ page 51)
- If you are driving with a child in the vehicle, observe the chapter entitled "Children in the vehicle" (→ page 62)

Information on the child restraint system

When installing a child restraint system, observe the notes in "Children in the vehicle" (→ page 62).

Notes on the child restraint system on the front passenger seat

⚠ WARNING Risk of injury or fatal injuries if the front passenger air bag is enabled

If the front passenger air bag is enabled, a child on the front passenger seat may be

struck by the front passenger air bag in the event of an accident.

▶ NEVER use a rearward-facing child restraint system on a seat with an ENABLED FRONT AIR BAG. This can result in the DEATH of or SERIOUS INJURY to the CHILD.

Also pay particular attention to the notes on rearward-facing or forward-facing child restraint systems on the front passenger seat (→ page 66).

Information on the automatic functions of the restraint system

Function of the automatic front passenger air bag shutoff

A person on the front passenger seat must observe the following information:

- Sit correctly (→ page 45).
- Fasten the seat belt correctly (→ page 46).

The automatic front passenger air bag shutoff can activate or deactivate the front passenger air bag and knee bag according to the situation.

Make sure you observe the following information:

- Status of the front passenger air bag: see "Function of the PASSENGER AIR BAG indicator lamps" (→ page 49).
- When installing a child restraint system on the front passenger seat, observe the vehicle-specific information (→ page 66).

Status of the front passenger air bag in relation to the stature of the person:

- **Front passenger air bag disabled:** PASSENGER AIR BAG OFF lights up continuously.
The front passenger air bag will not be deployed in the event of an accident. If PASSENGER AIR BAG OFF is lit, no one may use the front passenger seat.
- **Front passenger air bag enabled:** PASSENGER AIR BAG ON lights up for up to 60 seconds or until both the PASSENGER AIR BAG ON and OFF indicator lamps go out.

The front passenger air bag may be deployed during an accident. Observe the following information on the correct seat position (→ page 45).

Vehicles with rear seats: a person of smaller stature should use a rear seat.

System limits

The front passenger air bag may otherwise be disabled by mistake, for example, in the following situation:

- The front passenger transfers their weight by supporting themselves on a vehicle armrest.
- The front passenger sits in such a way that their weight is lifted off the seat surface.

! **NOTE** Deployment of components of the restraint system when the front passenger seat is unoccupied

In an accident, the components of the restraint system may deploy unnecessarily on the front passenger side if:

- There are heavy objects on the front passenger seat.
 - The seat belt tongue is engaged in the seat belt buckle of the front passenger seat and the front passenger seat is unoccupied.
- ▶ Store objects in a suitable place.
- ▶ Only one person should use each seat belt at any one time.

Depending on the accident situation detected, the window air bag on the front passenger side may deploy. The air bag will be deployed regardless of whether the front passenger seat is occupied.

Function of PRE-SAFE® (anticipatory occupant protection)

PRE-SAFE® is able to detect certain critical driving situations and implement pre-emptive measures to protect the vehicle occupants.

PRE-SAFE® can implement the following measures independently of each other:

- Tightening the seat belts on the driver's seat and front passenger seat.
- Closing the side windows.
- **Vehicles with sliding sunroof:** closing the sliding sunroof.
- **Vehicles with memory function:** moving the front passenger seat to a more favorable seat position.
- **Vehicles with multicontour seat:** increasing the lateral support by inflating the seat side bolsters of the seat backrest.
- **PRE-SAFE® Sound:** provided that the multimedia system is switched on, generating a brief noise signal to stimulate the innate protective mechanism of a person's hearing.

! **NOTE** Damage caused by objects in the footwell or behind the seat

The automatic adjustment of the seat position may result in damage to the seat and/or the object.

- ▶ Stow objects in a suitable place.

Reversing the PRE-SAFE® system measures

If an accident did not occur, the pre-emptive measures that were taken will be reversed.

You will need to perform certain settings yourself.

- ▶ If the seat belt pre-tensioning is not reduced, move the seat backrest back slightly. The locking mechanism will release.

Function of PRE-SAFE® PLUS (anticipatory occupant protection plus)

PRE-SAFE® PLUS can detect certain impacts, particularly an imminent rear impact, and take pre-emptive measures to protect the vehicle occu-

pants. These measures cannot necessarily prevent an imminent impact.

PRE-SAFE® PLUS can implement the following measures independently of each other:

- Tightening the seat belts on the driver's seat and front passenger seat.
- Increasing brake pressure when the vehicle is stationary. This brake application will be canceled automatically when the vehicle pulls away.

If an accident did not occur, the pre-emptive measures that were taken will be reversed.

System limits

The system will not initiate any action in the following situations:

- when the vehicle is backing up
or
- when the vehicle is towing a trailer and there is a risk of a rear impact

The system will not initiate any brake application in the following situations:

- while you are driving
or
- when you are entering or exiting a parking space while using Active Parking Assist

Function of PRE-SAFE® Impulse Side

If an imminent side impact is detected, PRE-SAFE® Impulse Side can pre-emptively move the front seat vehicle occupant's upper body towards the center of the vehicle. It does this by rapidly inflating an air cushion in the outer seat side bolster of the seat backrest on the side on which the impact is anticipated. This increases the distance between the door and the vehicle occupant.

If PRE-SAFE® Impulse Side has been deployed or is faulty, the [PRE-SAFE Pulse Side Inoperative](#) See Operator's Manual(→ page 452)display message will appear.

Seat belt adjustment function

Vehicles with PRE-SAFE®: after you have fastened the seat belt of the front seat, it may adjust itself against your body by pulling at the shoulder until somewhat tight. Do not hold the seat belt tightly while it is adjusting.

This function is a reminder that all vehicle occupants must wear their seat belts correctly.

You can activate and deactivate the seat belt adjustment function using the multimedia system (→ page 54).

Activating/deactivating seat belt adjustment via the multimedia system

Multimedia system:

- ➔  ➔ [Settings](#) ➔ [Vehicle](#)
- ➔ [Occupant Protection](#)
- ➔ Activate or deactivate [Belt adjustment](#).

Overview of the automatic measures after an accident

Depending on the type and severity of the accident, and depending on the vehicle's equipment, the following measures may be implemented, for example:

- automatic braking (post-collision brake)
- activating the hazard warning lamps
- triggering an automatic emergency call (→ page 367)
- switching off the drive system and high-voltage on-board electrical system
- unlocking the vehicle doors
- lowering the side windows
- displaying the emergency guide on the central display
- switching on the interior lighting

Function of the post-collision brake after an accident

Depending on the accident situation, the post-collision brake can minimise the severity of a further collision or even avoid it.

If an accident is detected, the post-collision brake can initiate automatic braking. When the vehicle has come to a standstill, the electric parking brake is automatically applied.

The driver can cancel automatic braking by taking the following actions:

- Braking more strongly than automatic braking
- Fully depressing the accelerator pedal with force

Purpose and function of the restraint system

Overview of deployment situations (restraint system)

Make sure that the following prerequisites in particular have been met so that the components of the restraint system are able to provide the intended level of protection:

- Sit correctly (→ page 45).
- Fasten the seat belt correctly (→ page 46).
 - Function of the seat belt warning lamp (→ page 48).
 - Function of the rear seat belt status display (→ page 49).
- The  restraint system warning lamp is not lit up after the self-test (→ page 47).
- The PASSENGER AIR BAG indicator lamps display the correct status of the front passenger air bag (→ page 49).

Depending on the detected deployment situation, the components of the restraint system can be activated or deployed independently of each other:

- Emergency Tensioning Device: frontal impact, rear impact, side impact, rollover
- Driver's air bag, front passenger air bag: frontal impact
- Knee bag: frontal impact
- Side impact air bag: side impact
- Window curtain air bag: side impact, rollover, frontal impact
- PRE-SAFE® Impulse Side: side impact

The installation location of an air bag is identified by the AIRBAG symbol (→ page 60).

Observe the information on the function of the restraint system (→ page 55).

Information on how the restraint system works

How the restraint system functions depends on the severity of the impact detected and the apparent type of accident.

For more information about types of accidents, see "Overview of deployment situations" (→ page 55).

The activation thresholds for the components of the restraint system are determined based on the evaluation of the sensor values measured at various points in the vehicle. This process is pre-emptive in nature. The triggering/deployment of the components of the restraint system must take place in good time at the start of the collision.

Factors that can be seen and measured only after a collision has occurred cannot play a decisive role in air bag deployment. Nor do they provide an indication of air bag deployment.

The vehicle may be deformed significantly without an air bag being deployed. This is the case if only parts which are relatively easily deformed are affected and the rate of vehicle deceleration is not high. Conversely, an air bag may be deployed even though the vehicle suffers only minor deformation. If very rigid vehicle parts such as longitudinal members are hit, this may result in sufficiently high levels of vehicle deceleration.

Depending on the apparent type of accident and the detected deployment situation, Emergency Tensioning Devices and/or air bags can supplement the protection offered by a correctly worn seat belt.

When enabled, an air bag can provide additional protection for the respective vehicle occupant.

Potential protection provided by each air bag:

- Knee air bag: thigh, knee and lower leg
- Driver's air bag, front passenger air bag: head and ribcage
- Window air bag: head
- Side air bag: ribcage, also pelvis for front seat occupants

However, no system available today can completely eliminate injuries and fatalities in every accident situation. In particular, the seat belt and air bag generally do not protect against objects penetrating the vehicle from the outside. It is also not possible to completely rule out the risk of injury caused by the air bag deploying.

Mercedes-Benz recommends that you have the vehicle towed to a qualified specialist workshop

after an accident. Take this into account, particularly if an Emergency Tensioning Device is triggered or an air bag deployed.

If the Emergency Tensioning Devices are triggered or an air bag is deployed, you will hear a bang, and a small amount of powder may also be released:

- The bang will not generally affect your hearing.
- In general, the powder released is not hazardous to health but may cause short-term breathing difficulties to persons suffering from asthma or other pulmonary conditions.

Provided it is safe to do so, leave the vehicle immediately or open the window in order to prevent breathing difficulties.

Air bags and pyrotechnic Emergency Tensioning Devices contain perchlorate material, which may require special handling or environmental protection measures. National guidelines regarding waste disposal must be observed. In California, see the <https://dtsc.ca.gov/>. Using the search function, you will find information on perchlorate, for example.

Information on the limited protection provided by the restraint system

Risk due to the incorrect behavior of vehicle occupants

All vehicle occupants must make sure of the following in particular:

- They observe the information on the correct seat position (→ page 45).
- There are no heavy, sharp-edged or fragile objects in the pockets of their clothing. Store such objects in a suitable place.

⚠ WARNING Risk of injury or death due to an incorrect seat position

The seat belt does not offer the intended level of protection if you have not moved the seat backrest to an almost vertical position.

In particular, you could slip beneath the seat-belt and become injured.

- ▶ Adjust the seat properly before beginning your journey.
- ▶ Always ensure that the seat backrest is in an almost vertical position and that

the shoulder belt is routed across the center of your shoulder.

Risk due to objects in the vehicle interior

All vehicle occupants must make sure of the following in particular:

- They observe the information on the correct seat position (→ page 45).
- There are no objects between the seat, door and door pillar (B-pillar).
- There are no hard objects, e.g. coat hangers, hanging on the grab handles or coat hooks.
- There are no heavy, sharp-edged or fragile objects in the pockets of their clothing. Store such objects in a suitable place.

⚠ WARNING Risk of injury or death due to blocked seat belt buckle or seat belt anchorage

Objects next to the front seat that block the seat belt buckle or the moving seat belt anchorage on the front seat impair the function of the Emergency Tensioning Devices.

- ▶ Before starting the journey, make sure that there are no objects around the seat belt buckle or between the front seat and door.

⚠ WARNING Risk of injury from objects in the deployment area of an airbag

Objects in the deployment area of an airbag can hinder or prevent the correct deployment of the airbag.

The airbag may then deploy in an uncontrolled manner and may even cause additional injuries to the vehicle occupants by deploying. This may be the case in particular if the airbag is integrated into the seat.

- ▶ Always stow and secure objects correctly.
- ▶ Before commencing your journey, make sure that no objects are stowed in the deployment area of an airbag.

The installation location of an air bag is identified by the AIRBAG (→ page 60) symbol.

Risk due to installing accessories

Do not attach accessories such as mobile navigation devices, mobile phones or cup holders within the deployment area of an air bag, e.g. on the cockpit, on the door, on the side window or on the side trim.

In addition, no connecting cables, tensioning straps or retaining straps may be routed or attached to the vehicle within the deployment area of an air bag. Always comply with the accessory manufacturer's installation instructions and, in particular, the notes on suitable places for installation.

▲ WARNING Risk of injury or death due to unsuitable protective covers

Unsuitable protective covers mean that air bags can no longer protect vehicle occupants as they are designed to do.

- ▶ Use only protective covers approved by Mercedes-Benz for the seat in question.

In addition, the function of the automatic passenger air bag deactivation may be restricted by an unsuitable protective cover. If the front

passenger seat is occupied, ensure that the PASSENGER AIR BAG indicator lamps display the correct status of the front passenger air bag (→ page 49).

Risk due to pets in the vehicle interior

▲ WARNING Risk of accident and injury due to animals left unsecured or unattended in the vehicle

If you leave animals in the vehicle unattended or unsecured, they could possibly press buttons or switches.

An animal may:

- Activate vehicle equipment and become trapped, for example
- Switch systems on or off and endanger other road users

Unsecured animals may be thrown around in the vehicle in the event of an accident or sudden steering and braking maneuvers and injure vehicle occupants in the process.

- ▶ Never leave animals in the vehicle unattended.
- ▶ Always correctly secure animals while driving, e.g. using a suitable animal carrier.

Risk due to modification, damage or wear to the components of the restraint system

▲ WARNING Risk of injury or death due to modifications to the restraint system

Vehicle occupants may no longer be protected as intended if alterations are made to the restraint system.

- ▶ Never alter the parts of the restraint system.
- ▶ Never tamper with the wiring or any electronic component parts or their software.

If it is necessary to modify the vehicle to accommodate a person with disabilities, contact an authorized Mercedes-Benz Center for details.

USA only: for details, contact our Customer Assistance Center on 1-800-FOR-MERCEdes (1-800-367-6372).

⚠ WARNING Risk of injury or death due to damaged or modified seat belts

Seat belts cannot provide protection in the following situations:

- The seat belt is damaged, has been modified, is extremely dirty, bleached or dyed
- The seat belt buckle is damaged or extremely dirty
- Modifications have been made to the Emergency Tensioning Device, seat belt anchorage or seat belt retractor

Seat belts may sustain non-visible damage in an accident, e.g. due to glass splinters.

Modified or damaged seat belts could tear or fail in the event of an accident, for example.

Modified Emergency Tensioning Devices could accidentally trigger or fail to function as intended.

- ▶ Never modify the seat belt system, for example the seat belt, seat belt buckle, Emergency Tensioning Device, seat belt anchorage and seat belt retractor.
- ▶ Make sure that the seat belts are undamaged, not worn and clean.
- ▶ Always have the seat belts checked immediately after an accident at a qualified specialist workshop.

Use only seat belts that have been approved for your vehicle by Mercedes-Benz.

⚠ WARNING Risk of injury due to modifications to the cover of an airbag

If you change the cover of an airbag or attach objects, e.g. even stickers, to it, the airbag may no longer function as intended.

- ▶ Never modify the cover of an airbag.
- ▶ Do not attach any objects to the cover.

The installation location of an air bag is identified by the AIRBAG symbol (→ page 60).

⚠ WARNING Risk of injury due to malfunctioning sensors in the door

The function of the airbags can be impaired due to modifications or incorrect work performed on the doors or door trim, or if the doors are damaged.

- ▶ Never modify the doors or parts of the doors.
- ▶ Always have work on the doors or door trim carried out at a qualified specialist workshop.

Risk due to components of the restraint system that have already been deployed

Mercedes-Benz recommends that you have the vehicle towed to a qualified specialist workshop after an accident.

⚠ WARNING Risk of burns from hot air bag components

The air bag parts are hot after an air bag has been deployed.

- ▶ Do not touch the air bag parts.

- ▶ Have a deployed air bag replaced at a qualified specialist workshop as soon as possible.

⚠ WARNING Risk of injury due to deployed airbag

A deployed airbag no longer offers any protection.

- ▶ Have the vehicle towed to a qualified specialist workshop in order to have the deployed airbag replaced.

Have deployed air bags replaced immediately.

⚠ WARNING Risk of injury or death from deployed pyrotechnic Emergency Tensioning Devices

Pyrotechnic Emergency Tensioning Devices that have been deployed are no longer operational and are unable to perform their intended protective function.

- ▶ Therefore, have deployed pyrotechnic Emergency Tensioning Devices immedi-

ately replaced at a qualified specialist workshop.

Seat belts

Releasing seat belts

- ▶ Press the release button in the seat belt buckle and guide the seat belt back with the seat belt tongue.

! **NOTE** Damage caused by trapping the seat belt

If an unused seat belt is not fully retracted, it may become trapped in the door or in the seat mechanism.

- ▶ Always ensure that an unused seat belt is fully retracted.

Airbags

Overview of air bags

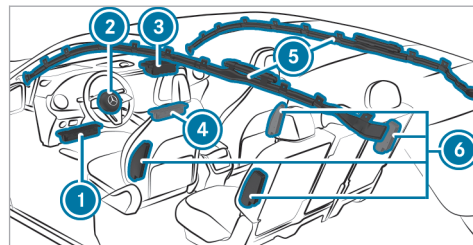

- ① Driver's knee bag
- ② Driver's air bag
- ③ Front passenger air bag
- ④ Front passenger knee bag
- ⑤ Window curtain air bag
- ⑥ Side impact air bag

The installation location of an air bag is identified by the AIRBAG symbol. An additional arrow symbol ▶ indicates the installation location for certain air bags.

Note the information in "Overview of deployment situations" (→ page 55).

Brief overview of most important points

Safely transporting children in the vehicle

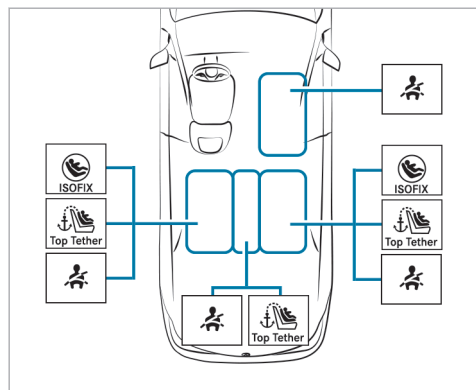

Always observe the following when transporting children:

- Never leave children unattended in the vehicle (→ page 64).

- Secure children up to a height of 5 ft (1.50 m) on the respective seat (see illustration above) properly with a suitable and approved child restraint system, and secure small children in a rearward-facing child restraint system.
- Observe the child restraint system manufacturer's installation instructions.

Left/right rear seat (preferred seats)



Preferred securing system:

-  LATCH-type (ISOFIX) securing rings

and

-  Also secure Top Tether if present (→ page 72).

Alternative securing system:

-  Vehicle seat belt
-  Additionally attach Top Tether if recommended by the manufacturer of the child restraint system (→ page 72).

Front passenger seat

Securing system:

-  Vehicle seat belt



Be sure to observe:

- If the front passenger seat is occupied, ensure that the status of the front passenger air bag is correct for the current situation (→ page 49).

(* rearward-facing child restraint system only in combination with automatic air bag shutoff)

Center rear seat

Securing system:

-  Vehicle seat belt
-  Additionally attach Top Tether if recommended by the manufacturer of the child restraint system (→ page 72).

Important safety notes**Basic information****Be diligent**

Bear in mind that negligence when securing a child in the child restraint system may have serious consequences. Always be diligent in securing a child carefully before every journey.

Never allow babies and children to travel sitting on the lap of another vehicle occupant.

To improve protection for children younger than 12 years old or under 5 ft (1.50 m) in height, Mercedes-Benz recommends you observe the following information:

- Always secure the child in a child restraint system suitable for this Mercedes-Benz vehicle.
- The child restraint system must be appropriate to the age, weight and size of the child.
- The vehicle seat must be suitable for the child restraint system to be installed:

Accident statistics show that children secured on the rear seats are generally safer than children secured on the front seats. For this reason,

Mercedes-Benz strongly advises that you install a child restraint system on a rear seat.

The generic term "child restraint system"

The generic term "child restraint system" is used in this Operator's Manual. A child restraint system is, for example:

- a baby car seat
- a rearward-facing child seat
- a forward-facing child seat
- a child booster seat – Mercedes-Benz recommends using a child booster seat **with** a backrest and seat belt guide.

Observe laws and legal requirements

Always observe the legal requirements when using a child restraint system in the vehicle.

Securing systems for child restraint systems in the vehicle

Use only the following securing systems for child restraint systems:

- the LATCH-type (ISOFIX) securing rings
- the vehicle's seat belt system

- the Top Tether anchorages

Simply attaching to the LATCH-type (ISOFIX) securing rings on the vehicle can reduce the risk of installing the child restraint system incorrectly.

When securing a child with the integrated seat belt of the ISOFIX child restraint system, always comply with the permissible gross weight for the child and child restraint system (→ page 71).

A child booster seat may be necessary to achieve proper seat belt positioning for children over 40 lbs (18 kg) in weight or until they reach a height at which a three-point seat belt can be installed properly without a child booster seat.

Mercedes-Benz recommends a suitable child booster seat with a backrest and seat belt guide.

Observe standards for child restraint systems

All child restraint systems must meet the following standards:

- U.S. Federal Motor Vehicle Safety Standards 213
- Canadian Motor Vehicle Safety Standards 213

Confirmation that the child restraint system complies with the standards can be found on an instruction label on the child restraint system. This confirmation can also be found in the installation instructions that are included with the child restraint system.

Important warning notices

Always secure a child restraint system correctly

⚠ WARNING Risk of injury or death due to incorrect installation of the child restraint system

The child can then not be protected or restrained as intended.

- ▶ Be sure to comply with the manufacturer's installation instructions for the child restraint system and its correct use.
- ▶ Make sure that the entire base of the child restraint system always rests on the sitting surface of the seat.

- ▶ Never place objects (e.g. cushions) under or behind the child restraint system.
- ▶ Use child restraint systems only with the original cover designed for them.
- ▶ Always replace damaged covers with genuine covers.

- Always observe the vehicle-specific information.
 - Installing an ISOFIX child restraint system on the right and left rear seats (→ page 71).
 - Securing the child restraint system with the seat belt (→ page 73).
- Observe the warning labels in the vehicle interior and on the child restraint system.

⚠ WARNING Risk of injury or death due to unsecured child restraint systems in the vehicle

If the child restraint system is incorrectly mounted or unsecured, it may come loose.

The child can then not be protected or restrained as intended.

Unused child restraint systems could be flung around and hit vehicle occupants.

- ▶ Always comply with the manufacturer's installation instructions for the child restraint system and its correct use.
- ▶ Always fit child restraint systems correctly, even if they are transported in the vehicle unused.

Do not modify the child restraint system

⚠ WARNING Risk of injury due to modifications to the child restraint system

The child restraint system can no longer function properly. This poses an increased risk of injury.

- ▶ Never modify a child restraint system.
- ▶ Only affix accessories which have been specially approved for this child restraint system by the child restraint system's manufacturer.

Use only child restraint systems that are in proper working condition

⚠ WARNING Risk of injury or death caused by the use of damaged child restraint systems

Child restraint systems or their retaining systems that have been subjected to stress in an accident may not be able to perform their intended protective function.

It may be the case that the child cannot be properly restrained.

- ▶ Always immediately replace child restraint systems that have been damaged or involved in an accident.
- ▶ Have the securing systems for the child restraint systems checked at a qualified specialist workshop before installing a child restraint system again.

Avoid direct sunlight

⚠ WARNING Risk of burns when the child seat is exposed to direct sunlight

If the child restraint system is exposed to direct sunlight or heat, parts could heat up excessively.

Children could suffer burns from these parts, particularly the metallic parts of the child restraint system.

- ▶ Always make sure that the child restraint system is not exposed to direct sunlight.
- ▶ Cover the child restraint system with a blanket, for example.
- ▶ If the child restraint system has been exposed to direct sunlight, allow it to cool before securing a child into it.
- ▶ Never leave children unattended in the vehicle.

Observe when stopping or parking

⚠ WARNING Risk of fatal injury due to exposure to extreme heat or cold in the vehicle

If persons, particularly children, are subjected to prolonged exposure to intense heat or cold, there is a risk of severe injury or even death.

- ▶ Never leave persons, particularly children, unattended in the vehicle.

⚠ WARNING Risk of accident and injury due to children left unattended in the vehicle

If you leave children unattended in the vehicle, they could, in particular:

- open doors, thereby endangering other persons or road users.
- get out and be struck by oncoming traffic.
- operate vehicle equipment and become trapped, for example.

In addition, the children could also set the vehicle in motion by, for example:

- releasing the parking brake.
- changing the gearbox position.
- starting the vehicle.

- ▶ Never leave children unattended in the vehicle.
- ▶ When leaving the vehicle, always take the key with you and lock the vehicle.
- ▶ Keep the key out of reach of children.

Notes on rearward-facing and forward-facing child restraint systems on the front passenger seat

▲ WARNING Risk of injury or fatal injury when using a rearward-facing child restraint system while the co-driver airbag is enabled

If you secure a child in a rearward-facing child restraint system on the co-driver seat and the PASSENGER AIR BAG OFF indicator lamp is

off, the co-driver airbag can deploy in the event of an accident.

The child could be struck by the airbag.

- ▶ Always ensure that the co-driver airbag is disabled. The PASSENGER AIR BAG OFF indicator lamp must be lit.
- ▶ NEVER use a rearward-facing child restraint system on a seat with an ENABLED FRONT AIRBAG; DEATH or SERIOUS INJURY to the CHILD can occur.

Observe the specific instructions for the rearward-facing and forward-facing child restraint systems (→ page 68).

If it is absolutely necessary to install a child restraint system on the front passenger seat, always observe the additional notes.

- When using a rearward-facing child restraint system on the front passenger seat, the front passenger air bag must always be disabled. This is the case only if the PASSENGER AIR BAG OFF indicator lamp is lit continuously (→ page 49).

- The front passenger air bag is enabled when the PASSENGER AIR BAG OFF indicator lamp is not lit. The front passenger air bag may be deployed during an accident. In that case, do not use rearward-facing child restraint systems.

Information on automatic front passenger air bag shutoff

If the front passenger seat is occupied, ensure, both before and during the journey, that the status of the front passenger air bag is correct for the current situation.

▲ WARNING Risk of injury or death due to objects between the seat surface and the child restraint system

Objects between the seat surface and the child restraint system can interfere with the function of the automatic front passenger air bag shutoff.

- ▶ Do not place any objects between the seat surface and the child restraint system.
- ▶ Make sure that the entire base of the child restraint system rests on the seat cushion of the front passenger seat.
- ▶ The backrest of a forward-facing child restraint system must, as far as possible, be resting against the seat backrest of the front passenger seat.
- ▶ Always comply with the installation instructions from the child restraint system manufacturer.

When installing a child restraint system on the front passenger seat, observe the vehicle-specific information (→ page 66).

Rearward-facing child restraint system on the front passenger seat

If a rearward-facing child restraint system is installed on the front passenger seat, the front passenger air bag must be disabled. The PASSENGER AIR BAG OFF indicator lamp must be continuously lit (→ page 49).

⚠ WARNING Risk of injury or fatal injury when using a rearward-facing child restraint system while the co-driver airbag is enabled

If you secure a child in a rearward-facing child restraint system on the co-driver seat and the PASSENGER AIR BAG OFF indicator lamp is off, the co-driver airbag can deploy in the event of an accident.

The child could be struck by the airbag.

- ▶ Always ensure that the co-driver airbag is disabled. The PASSENGER AIR BAG OFF indicator lamp must be lit.
- ▶ NEVER use a rearward-facing child restraint system on a seat with an ENABLED FRONT AIRBAG; DEATH or SERIOUS INJURY to the CHILD can occur.

- ⓘ Depending on the child restraint system and the stature of the child, the front passenger air bag will be enabled. The PASSENGER AIR BAG OFF indicator lamp will not light up. The front passenger air bag may be deployed during an accident. If the front passenger air

bag has this status, no rearward-facing child restraint system may be installed on the front passenger seat. Instead, install the rearward-facing child restraint system on a suitable rear seat.

Forward-facing child restraint system on the front passenger seat

If a forward-facing child restraint system is installed on the front passenger seat, the front passenger air bag may be automatically enabled or disabled. The status of the front passenger air bag depends on the child restraint system and the stature of the child.

The PASSENGER AIR BAG OFF indicator lamp will either light up continuously or not light up (→ page 49). Always observe the following information.

⚠ WARNING Risk of injury or death due to incorrect positioning of the child restraint system

If you secure a child in a forward-facing child restraint system on the co-driver seat and you position the co-driver seat too close to the dashboard, in the event of an accident, the child could:

- come into contact with the vehicle's interior if the PASSENGER AIR BAG OFF indicator lamp is lit, for example
 - be struck by the airbag if the PASSENGER AIR BAG OFF indicator lamp is off
- ▶ Always move the co-driver seat as far back as possible. In doing so, always make sure that the shoulder belt strap is correctly routed from the seat belt outlet of the vehicle to the shoulder belt guide on the child restraint system. The shoulder belt strap must be routed forwards and downwards from the seat belt outlet. If necessary, adjust the seat belt outlet and the co-driver seat accordingly.

▶ Always comply with the child restraint system manufacturer's installation instructions.

Be sure to also observe the following further related subjects:

- Function of the automatic front passenger air bag shutoff (→ page 49)

Suitable child restraint systems for the transport of children

Information on the benefit of a rearward-facing child restraint system

Transport a baby in a suitable rearward-facing child restraint system only. It is also preferable to transport a small child in a suitable rearward-facing child restraint system. In this case, the child sits in the opposite direction to the direction of travel and faces backwards.

Babies and small children have comparatively weak neck muscles in relation to the sizes and weights of their heads. The risk of injury to the

cervical spine during an accident can be reduced in a rearward-facing child restraint system.

Securing the child restraint system

Adjusting the seat correctly

When installing a child restraint system on the left or right rear seat, always observe the following:

- ▶ Make sure that the child's feet do not touch the front seat. If necessary, move the front seat slightly forwards.

If the head restraint of the child restraint system cannot be fully extended when it is installed in the vehicle, this will result in restrictions on the maximum size setting for certain child restraint systems. Observe the child restraint system manufacturer's installation instructions.

- ⓘ Contact with the roof when the head restraint is fully extended and locked in place will not result in any restrictions on use.

 **When installing an ISOFIX child restraint system, also observe the following:**

- ▶ **When using a rearward-facing child restraint system on a rear seat:** adjust the front seat so that it does not touch the child restraint system.
- ▶ **When using a forward-facing child restraint system with integrated child seat belt:** adjust the head restraint of the respective seat so that it does not push the child restraint system forwards. If necessary, the respective head restraint can be removed. In addition, the backrest of the child restraint system must lie as flat as possible against the backrest of the vehicle seat. After the child restraint system has been removed, replace the vehicle head restraint immediately and adjust correctly.
- ▶ The child restraint system must not be put under strain between the roof and the seat cushion and/or be installed facing the wrong direction. Where possible, adjust the seat cushion inclination accordingly.

- ▶ Adjust the vehicle head restraints so that the child restraint system is not put under strain by the head restraint.

 **When installing a belt-secured child restraint system, also observe the following:**

- ▶ **When using a rearward-facing child restraint system on a rear seat:** adjust the front seat so that it does not touch the child restraint system.
- ▶ Also secure Top Tether if available (→ page 72)
- ▶ **When using a forward-facing child restraint system with integrated child seat belt:** adjust the head restraint of the respective seat so that it does not push the child restraint system forwards. If necessary, the respective head restraint can be removed. In addition, the backrest of the child restraint system must lie as flat as possible against the backrest of the vehicle seat. After the child restraint system has been removed, replace the vehicle head restraint immediately and adjust correctly.

- ▶ The backrest of the forward-facing child restraint system must, as far as possible, be resting on the seat backrest of the rear seat.
- ▶ The child restraint system must not be put under strain between the roof and the seat cushion and/or be installed facing the wrong direction. Where possible, adjust the seat cushion inclination accordingly.
- ▶ Adjust the vehicle head restraints so that the child restraint system is not put under strain by the head restraint.
- ▶ Make sure that the child's feet do not touch the front seat. If necessary, move the front seat slightly forwards.

 **Depending on the vehicle equipment, always observe the following when installing a belt-secured child restraint system on the front passenger seat:**

- ▶ Observe the notes on rearward-facing and forward-facing child restraint systems on the front passenger seat (→ page 66).
- ▶ **When using a forward-facing child restraint system with integrated child seat belt:** remove

the head restraint from the respective seat, if possible. After the child restraint system has been removed, immediately replace the head restraint and adjust correctly.

- ▶ The backrest of the forward-facing child restraint system must, as far as possible, be resting on the seat backrest of the front passenger seat.
- ▶ The child restraint system must not be put under strain between the roof and the seat cushion and/or be installed facing the wrong direction.
- ▶ Adjust the vehicle head restraints so that the child restraint system is not put under strain by the head restraint.
- ▶ Never place objects (e.g. cushions) under or behind the child restraint system.
- ▶ Set the front passenger seat as far back as possible and move the seat into the highest position if possible. Always make sure that the shoulder belt strap is correctly routed from the seat belt outlet of the vehicle to the shoulder belt guide on the child restraint system. The shoulder belt strap must be routed for-

wards from the seat belt outlet and, where possible, downwards to the child restraint system.

- ▶ Fully retract the seat cushion length adjustment.
- ▶ Adjust the seat cushion inclination so that the front edge of the seat cushion is in the highest position and the rear edge of the seat cushion is in the lowest position.
- ▶ Set the seat backrest to the most vertical position possible.

Activating or deactivating the special seat belt retractor of the seat belt

⚠ WARNING Risk of injury or death if a seat belt is unfastened while the vehicle is in motion

If the seat belt is released while the vehicle is in motion, the special seat belt retractor is deactivated and the child restraint system is no longer correctly secured. The seat belt is drawn in slightly by the inertia reel and cannot be immediately closed again.

- ▶ Stop the vehicle immediately in accordance with the traffic conditions.
- ▶ Activate the special seat belt retractor again and correctly secure the child restraint system.

When enabled, the child seat safety feature ensures that the seat belts of the front passenger seat and rear seats do not slacken once the child restraint system is secured.

The seat belts on the following seats are equipped with a child seat safety feature:

- Front passenger seat
- Rear seats

Installing a child restraint system

- ▶ When installing a child restraint system, always observe the manufacturer's installation and operating instructions as well as the information in this Operator's Manual.
- ▶ Pull the seat belt smoothly from the seat belt outlet.
- ▶ Engage the seat belt tongue in the belt buckle.

Activating the special seat belt retractor:

- ▶ Pull the seat belt out fully and let the inertia reel retract it again. When the special seat belt retractor is activated, you should hear a ratcheting sound.
- ▶ Push the child restraint system down until the seat belt sits tightly.

Deactivating the special seat belt retractor:

- ▶ Press the release button of the seat belt buckle.
- ▶ Hold the seat belt tongue and guide back to the seat belt outlet.

Installing an ISOFIX child restraint system

⚠ WARNING Risk of accident if the rear bench seat, rear seat and seat backrest are not engaged

The rear bench seat, rear seat and seat backrest may fold forwards, even when you are driving.

- As a result, the vehicle occupant will be pushed into the seat belt with increased force. The seat belt will not be able to protect as intended and could cause additional injury.
- Objects or loads in the trunk or cargo compartment will not be restrained by the seat backrest.
- ▶ Make sure that the rear bench seat, the rear seat and the seat backrest are engaged before every trip.

If the rear seat backrest is not engaged and locked in place, the red lock verification indicator will be visible.

⚠ WARNING Risk of injury or death if the permissible gross mass of the child and child restraint system together is exceeded.

Too much load may be placed on the LATCH-type (ISOFIX) or iSize child restraint systems and the child may not be restrained correctly in the event of an accident, for example.

- ▶ If the child is secured in a LATCH-type (ISOFIX) child restraint system with integrated seat belt, the total mass of the child and child restraint system must not exceed 73 lb (33 kg).

Always comply with the information about the mass of the child:

- in the manufacturer's installation and operating instructions for the child restraint system used
- on a label on the child restraint system, if present

Regularly check that the permissible gross mass of the child and child restraint system is still complied with.

When installing a child restraint system, observe the following:

- ✓ Always observe the correct use of the seats and consider their suitability for attaching a child restraint system.
ISOFIX mounting brackets

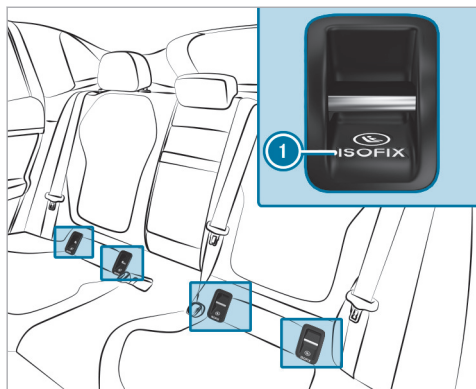

1 ISOFIX mounting bracket

Before every journey, make sure that the ISOFIX/LATCH child restraint system is engaged correctly in both mounting brackets in the vehicle.

! **NOTE** Damage to the seat belt for the center seat during installation of the child restraint system

▶ Make sure that the seat belt is not trapped.

- ▶ Remove and stow away the respective covers of the ISOFIX mounting brackets 1.
- ▶ Attach the ISOFIX/LATCH child restraint system to both mounting brackets in the vehicle.
- ▶ After removing the child seat, replace the cover of the LATCH-type (ISOFIX) mounting brackets 1.

Fastening a Top Tether

! **WARNING** Risk of injury or death if the rear seat backrests are not locked after Top Tether belts are installed

The rear seat backrests may fold forwards when you are driving.

As a result, child restraint systems will no longer be able to perform their intended protective function. This may also cause additional injuries.

- ▶ Always lock rear seat backrests after installing Top Tether belts.
- ▶ Observe the lock verification indicator.

If the rear seat backrest is not engaged and locked in place, the red lock verification indicator will be visible.

 If the child restraint system is equipped with a Top Tether belt:

The risk of injury may be reduced by Top Tether. The Top Tether belt enables an additional connection between the child restraint system attached with ISOFIX (left and right rear seats) or the seat belt (all rear seats) and the vehicle.

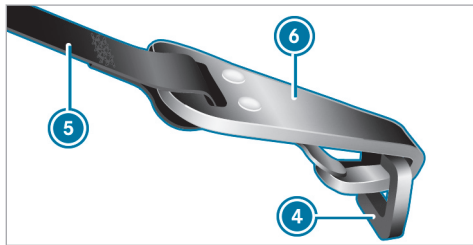
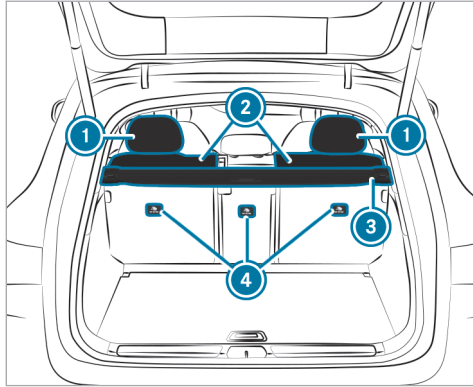

- ▶ If necessary, slide head restraint ① upwards (→ page 115).
- ▶ Install the ISOFIX or belt-secured child restraint system with Top Tether. In doing so, comply with the child restraint system manufacturer's installation instructions.
- ▶ Guide Top Tether belt ⑤ under head restraint ① between the two head restraint bars.
- ▶ Guide Top Tether belt ⑤ downwards between cargo compartment cover ③ and seat backrest ②.
- ▶ Hook Top Tether hook ⑥ of Top Tether belt ⑤ into Top Tether anchorage ④ without twisting.
- ▶ Tension Top Tether belt ⑤. In doing so, comply with the child restraint system manufacturer's installation instructions.
- ▶ If necessary, slide head restraint ① downwards (→ page 115). Make sure that you do not interfere with the correct routing of Top Tether belt ⑤.

Securing the child restraint system with the seat belt

⚠ WARNING Risk of accident if the rear bench seat, rear seat and seat backrest are not engaged

The rear bench seat, rear seat and seat backrest may fold forwards, even when you are driving.

- As a result, the vehicle occupant will be pushed into the seat belt with increased force. The seat belt will not be able to protect as intended and could cause additional injury.
- Objects or loads in the trunk or cargo compartment will not be restrained by the seat backrest.

▶ Make sure that the rear bench seat, the rear seat and the seat backrest are engaged before every trip.

If the rear seat backrest is not engaged and locked in place, the red lock verification indicator will be visible.

The seat belts on the following seats are equipped with a child seat safety feature:

- Front passenger seat
- Rear seats

When enabled, the child seat safety feature ensures that the seat belts of the front passenger seat and rear seats do not slacken once the child restraint system is secured.

- ▶ For a child restraint system in the "Universal" or "Semi-Universal" category, make sure that the system has been approved for the vehicle seat.
- ▶ Install the child restraint system. The entire base of the child restraint system must always rest on the sitting surface of the seat.
- ▶ Always make sure that the shoulder belt strap is correctly routed from the seat belt outlet of the vehicle to the shoulder belt guide on the child restraint system. The shoulder belt strap must be routed forwards from the seat belt outlet and, where

possible, downwards to the child restraint system.

- ▶ **When installing on the rear seat:** also secure Top Tether if present.
- ▶ **When installing on the front passenger seat:** if necessary, adjust the seat belt outlet and the front passenger seat accordingly.

Child safety locks

Activating/deactivating the child safety lock for the rear doors

⚠ WARNING Risk of accident and injury due to children left unattended in the vehicle

If you leave children unattended in the vehicle, they could, in particular:

- open doors, thereby endangering other persons or road users.
- get out and be struck by oncoming traffic.
- operate vehicle equipment and become trapped, for example.

In addition, the children could also set the vehicle in motion by, for example:

- releasing the parking brake.
- changing the gearbox position.
- starting the vehicle.
- ▶ Never leave children unattended in the vehicle.
- ▶ When leaving the vehicle, always take the key with you and lock the vehicle.
- ▶ Keep the key out of reach of children.

⚠ WARNING Risk of fatal injury due to exposure to extreme heat or cold in the vehicle

If persons, particularly children, are subjected to prolonged exposure to intense heat or cold, there is a risk of severe injury or even death.

- ▶ Never leave persons, particularly children, unattended in the vehicle.

⚠ WARNING Risk of accident and injury due to children left unattended in the vehicle

If children are traveling in the vehicle, they could, in particular:

- Open doors, thereby endangering other persons or road users
 - Get out and be struck by oncoming traffic
 - Operate vehicle equipment and become trapped, for example
- ▶ Always activate the child safety locks installed if children are traveling in the vehicle.
- ▶ Never leave children unattended in the vehicle.
- ▶ When leaving the vehicle, always take the SmartKey with you and lock the vehicle.

There are child safety locks for the rear doors and the rear side windows.

The child safety lock on the rear doors secures each door separately. The doors can no longer be opened from the inside.

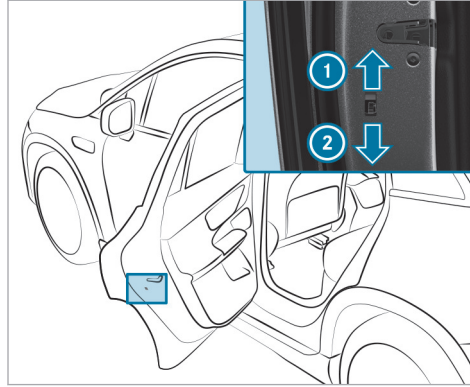

- ▶ Press the lever in direction ① (activate) or ② (deactivate).
- ▶ Make sure that the child safety locks are working properly.

Activating/deactivating the child safety lock for the rear side windows

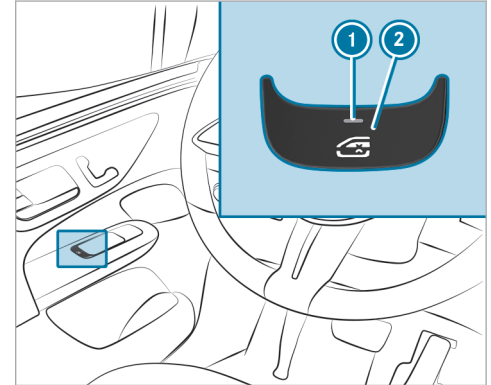

- ▶ **To activate/deactivate:** press button ②.
- The rear side window can be opened or closed as follows:
- Indicator lamp ① is lit: via the switch on the driver's door

- Indicator lamp  is off: via the switch on the corresponding rear door or driver's door

When the child safety lock is activated, the controls in the rear passenger compartment are disabled for:

- the rear side windows
- the adjustment of the front passenger seat from the rear passenger compartment
- the roller sunblinds in the roof

Occupant presence reminder

Function of the occupant presence reminder

The occupant presence reminder can help to remind you about a child who may have been forgotten in the rear compartment of the vehicle. It will activate and deactivate automatically when the rear door is open for an extended period of time and a child, which the system presumes to be present, could enter or exit the vehicle.

When the vehicle is switched off, the **Do Not Leave People or Animals in the Vehicle** message

will appear on the driver display if the system has previously activated automatically.

You can permanently deactivate the function in the multimedia system (→ page 76). When the system is deactivated, the  indicator lamp on the driver's display will light up.

Activating or deactivating the occupant presence reminder in the multimedia system

Multimedia system:

    Settings  Vehicle

 Occupant Protection

- ▶ Activate or deactivate the function.

SmartKey

Overview of key functions

⚠ WARNING Risk of accident and injury due to children left unattended in the vehicle

If you leave children unattended in the vehicle, they could, in particular:

- open doors, thereby endangering other persons or road users.
- get out and be struck by oncoming traffic.
- operate vehicle equipment and become trapped, for example.

In addition, the children could also set the vehicle in motion by, for example:

- releasing the parking brake.
- changing the gearbox position.
- starting the vehicle.

▶ Never leave children unattended in the vehicle.

- ▶ When leaving the vehicle, always take the key with you and lock the vehicle.
- ▶ Keep the key out of reach of children.

This also applies to the Digital Vehicle Key.

! NOTE Damage to the SmartKey caused by magnetic fields



- ▶ Keep the SmartKey away from strong magnetic fields.





Vehicle key with panic alarm

- ① Opens/closes the tailgate
- ② Unlocks (with embossed surface)

- ③ Locks
- ④ Indicator lamp
- ⑤ Panic alarm

ⓘ If indicator lamp ④ does not light up after you press the  or  button, the battery is weak or possibly discharged. Replace the battery as soon as possible.

Replace the key battery (→ page 79).

ⓘ **Vehicles with convenience doors:** if you have activated the convenience doors function in the multimedia system (→ page 91), you can open or close the driver's or front passenger door by pressing the  or  button. Additional information on the convenience doors (→ page 87).

The key locks and unlocks the following components:

- Doors
- Socket flap
- Tailgate

If the vehicle is not opened within approximately 40 seconds after unlocking, it will lock again. Anti-theft protection will be armed again.

Do not keep the key together with electronic devices or metal objects. This can affect the key's functionality.

Activating/deactivating the acoustic locking verification signal

Multimedia system:

→ [Home] → Settings → Vehicle

→ Open/Close

▶ Activate or deactivate the Acoustic Lock.

Activating/deactivating the panic alarm

Requirements:

- The vehicle is switched off.

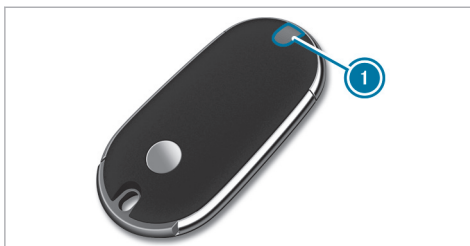

▶ **To activate:** press button ① for approximately one second.

A visual and audible alarm is triggered.

▶ **To deactivate:** briefly press button ① again.

or

▶ Press the start/stop button.

A SmartKey belonging to the vehicle must be detected in the vehicle.

Changing the unlocking settings

Possible unlocking functions of the SmartKey:

- Central unlocking
- Unlocking the driver's door and socket flap

▶ **To switch between settings:** press the [Lock] and [Unlock] buttons simultaneously for approximately six seconds until the indicator lamp flashes twice.

Options if the unlocking function for the driver's door and socket flap has been selected:



- **To unlock the vehicle centrally:** press the [Lock] button twice.
- **Vehicles with KEYLESS-GO:** if you touch the inner surface of the door handle on the driver's door, only the driver's door and the socket flap are unlocked.

Deactivating the function of the key

Vehicles with KEYLESS-GO: if you deactivate the function of the key, the KEYLESS-GO functions are also deactivated. Access or drive authorization by KEYLESS-GO is then no longer possible with that particular key. Activate the function of the key so that all its functions will again be available.

You can also deactivate the function of the key to reduce the energy consumption of the key if you

do not use the vehicle or a key for an extended period of time.

- ▶ Press and hold the  button on the key.
- ▶ With the key button  pressed, immediately press key button  twice in quick succession. The indicator light of the key lights up once briefly and once for a long time.

i You have the following options to reactivate the key:

- Press any button on the key.
- Start the vehicle with the key in the center console stowage space (→ page 184).

Removing/inserting the emergency key

Removing the emergency key

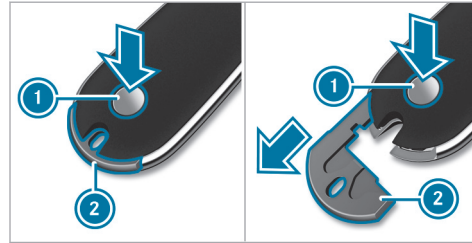

- ▶ Press release button **1**. Emergency key **2** will be pushed out slightly.
- ▶ Fully remove emergency key **2**.

Inserting the emergency key

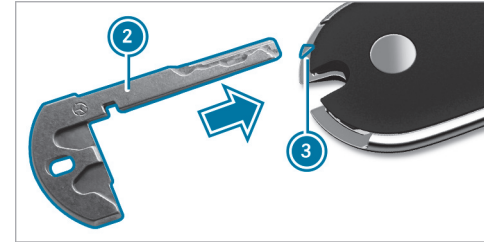

- ▶ Insert emergency key **2** at marking **3** until it engages.
- i** You can use emergency key **2** to attach the SmartKey to a key ring.

Replacing the key battery

⚠ DANGER Risk of fatal injuries due to swallowing batteries

Batteries contain toxic and corrosive substances. If batteries are swallowed or otherwise

enter the body, severe internal burns can occur within two hours.

There is a risk of fatal injury.

- ▶ Keep batteries out of the reach of children.
- ▶ If the battery compartment cover and/or lid do not close securely, stop using the key and keep it away from children.
- ▶ If batteries are swallowed or otherwise enter the body, seek immediate medical attention.

 **ENVIRONMENTAL NOTE** Environmental damage due to improper disposal of batteries



Batteries contain pollutants. It is illegal to dispose of them with the household rubbish.



Dispose of batteries in an environmentally responsible manner. Take discharged batteries to a qualified specialist workshop or to a collection point for used batteries.

Requirements

- You require a CR 2032 3 V cell battery.

Mercedes-Benz recommends that you have the battery replaced at a qualified specialist workshop.

- ▶ Remove the emergency key (→ page 79).

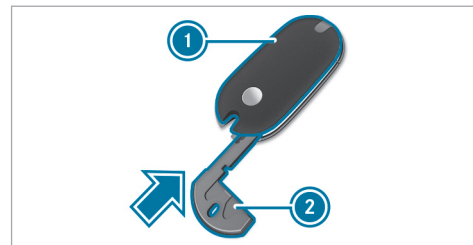

- ▶ Press emergency key ② into the opening in the key in the direction of the arrow until cover ① opens. When doing so, do not hold cover ① closed.

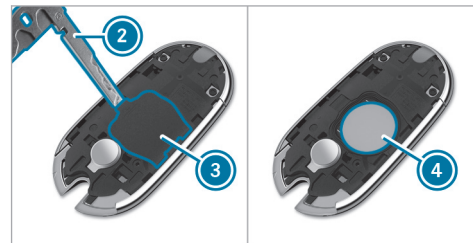

- ▶ Insert emergency key ② into the opening and lift up covering ③ and remove it.
- ▶ Repeatedly tap the key against your palm until battery ④ falls out of the key.
- ▶ Insert the new battery with the positive pole facing upwards. Use a lint-free cloth to do so.
- ▶ Make sure that the surface of the battery is free of lint, grease and other impurities.
- ▶ Insert the front tabs of covering ③ into the housing and then press on both sides to close it.
- ▶ Make sure that covering ③ is completely closed.
- ▶ Insert the front tabs of cover ① into the housing and then press until it is completely closed.
- ▶ Insert the emergency key again (→ page 79).

Problems with the key, troubleshooting

You can no longer lock or unlock the vehicle

Possible causes are:

- The key battery is weak or discharged.
- ▶ Check the battery using the indicator lamp (→ page 77).
- ▶ Replace the key battery, if necessary (→ page 79).
- ▶ Use the replacement key.
- ▶ Use the mechanical key to lock or unlock (→ page 92).
- ▶ Have key checked at a qualified specialist workshop.

There is interference from a powerful radio signal source

Possible causes if the function of the key is impaired:

- high voltage power lines
- mobile phones
- electronic devices (notebooks, tablets)

- shielding due to metal objects or induction loops for electrical gate systems or automatic barriers

- ▶ Make sure that there is sufficient distance between the key and the potential source of interference.

You have lost a key

- ▶ Have the key deactivated at a qualified specialist workshop.
- ▶ If necessary, have the mechanical lock replaced as well.

Digital Vehicle Key

Unlocking and locking the vehicle with the digital vehicle key

Requirements

- The vehicle is equipped with the "Digital Vehicle Key" pre-installation.
- The "Digital Vehicle Key" function is activated via Mercedes me: <https://www.mercedes.me>.

- A suitable end device is activated as a Digital Vehicle Key.
- Bluetooth® is switched on at the end device and at the vehicle.
- The terminal is sufficiently charged.
- ① If the connection via Bluetooth® is faulty or the battery of the digital vehicle key is empty, you can also lock, unlock or start the vehicle via the NFC function. (→ page 183).

The Digital Vehicle Key can be used for the following functions:

- Locking and unlocking the vehicle with the NFC function
- Locking/unlocking the vehicle with KEYLESS-GO (→ page 84)
- HANDS-FREE ACCESS function (→ page 97)
- Convenience closing (closing the vehicle from outside) (→ page 102)
- Anti-theft protection (→ page 107)
- Starting the vehicle (→ page 183) or parking (→ page 217)

- Starting the vehicle with the digital vehicle key in the storage compartment (emergency mode) (→ page 183)
- ① Mercedes-Benz recommends that you carry the emergency key in case of function restrictions (→ page 79).
- ① Mercedes-Benz recommends that you place the digital vehicle key in the stowage compartment while driving (→ page 183).
- ① For more information on the digital vehicle key, see the digital Operator's Manual.

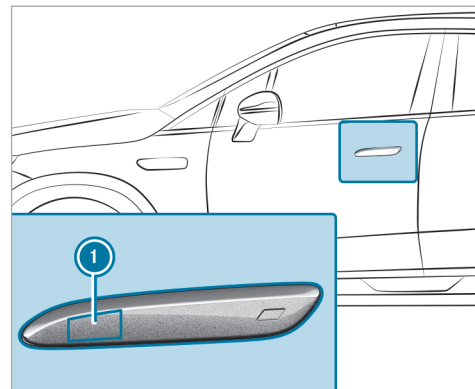

▶ **Locking and unlocking the vehicle with the NFC function** Stop the digital vehicle key in the area of the NFC antenna ① on the door handle.

Rectifying problems with the Digital Vehicle Key

You can no longer lock and unlock the vehicle with the Digital Vehicle Key.

Possible causes:

- Bluetooth® is switched off on the Digital Vehicle Key or on the vehicle.
 - The battery of the Digital Vehicle Key is low or empty.
- ▶ Switch on Bluetooth® on the digital vehicle key or on the vehicle.
 - ▶ Check the state of charge of the Digital Vehicle Key battery.
 - ▶ If necessary, charge the battery of the Digital Vehicle Key.
 - ▶ Use the NFC function of the Digital Vehicle Key to lock or unlock the vehicle. (→ page 81).
 - ▶ Use the vehicle key.
 - ▶ Use the emergency key element for locking or unlocking (→ page 92).

- ▶ Have the vehicle and the Digital Vehicle Key checked at a qualified specialist workshop.

There is interference from a powerful radio signal source

Possible causes of Digital Vehicle Key impairment:

- high voltage power lines
 - mobile phones
 - electronic devices (notebooks, tablets)
 - shielding due to metal objects or induction loops for electrical gate systems or automatic barriers
- ▶ Ensure sufficient distance between the Digital Vehicle Key and a potential source of interference.

You have lost a Digital Vehicle Key.

- ▶ Remove the Digital Vehicle Key.
- ⓘ For information on removing the Digital Vehicle Key, see the digital Operator's Manual.

Doors

Unlocking/opening the doors from the inside

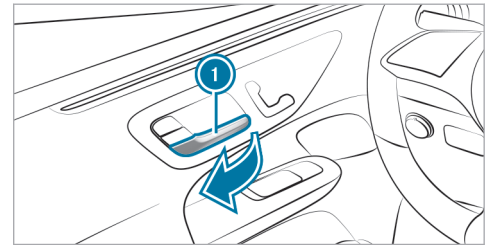

- ▶ **To unlock and open a front door:** pull door handle ①.
- ▶ **To unlock a rear door:** pull the rear door handle.
- ▶ **To open a rear door:** pull the rear door handle again.

Centrally locking and unlocking the vehicle from the inside

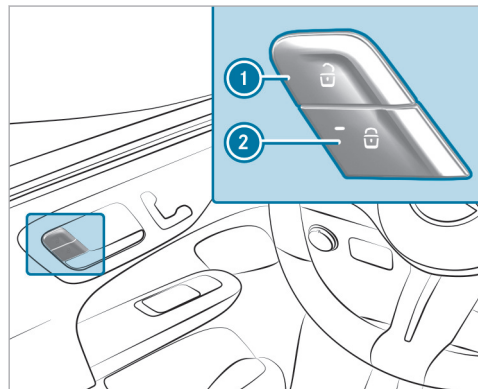

▶ **To unlock:** press button ①.

▶ **To lock:** press button ②.

The red indicator lamp on button ② will light up once the vehicle is locked.

① The buttons are also on the front passenger and rear doors.

The socket flap is also locked and unlocked. The socket flap can be opened even if a key is detected in the car.

The vehicle will not be unlocked:

- if you have locked the vehicle using the key
- if you have locked the vehicle using KEYLESS-GO

Recessed door handles extend or retract

The door handles extend automatically:

- when you unlock the vehicle with the key
- when you touch the outer sensor surface of the door handle (when the vehicle is unlocked)

The door handles retract automatically:

- when you lock the vehicle with the key
- when pulling away
- after waiting for a time

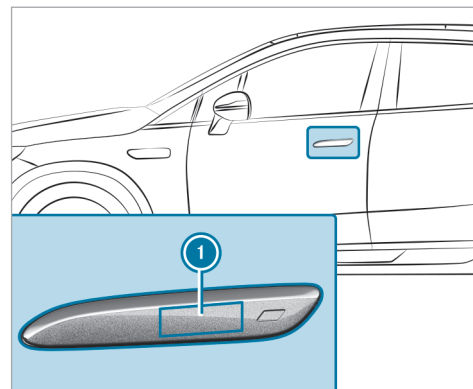

▶ **Extend the door handle:** Touch the outer ① sensor surface.

Locking/unlocking the vehicle with KEYLESS-GO

Requirements

- The key is outside the vehicle.
- The distance between the key and the vehicle does not exceed 3 ft (1 m).

- The driver's door and the door on which the door handle is used are closed.

i Vehicles with Digital Vehicle Key: You can use the Digital Vehicle Key like the conventional vehicle key.

The door handles extend automatically:

- when a vehicle key is detected (the vehicle is then not yet unlocked)
- when you unlock the vehicle with the key
- when you touch the outer sensor surface of the door handle to unlock it

The door handles retract automatically:

- when you lock the vehicle with the key
- when you touch the recessed sensor surface of the door handle to lock it
- after comfort locking (→ page 102)
- when pulling away
- after waiting for a time

! **NOTE** Vehicle damage due to unintentional opening of the tailgate or a door

- When using an automatic car wash
- When using a high pressure cleaner

▶ Deactivate the function of the SmartKey in these situations.

or

▶ Make sure that the SmartKey is at a minimum distance of 10 ft (3 m) (power washer) or 20 ft (6 m) (automatic car wash) away from the vehicle.

Vehicles with digital vehicle key:

! **NOTE** Vehicle damage due to unintentional opening of the tailgate or a door

- when using an automatic car wash
- when using a power washer

▶ In these situations, switch off the Digital Vehicle Key.

or

▶ Make sure that the Digital Vehicle Key is at least 10 ft (3 m) (power washer) or 20 ft (6 m) (car wash) away from the vehicle.

Observe the notes:

- on washing the vehicle in a car wash (→ page 381)
- on using a power washer (→ page 383)

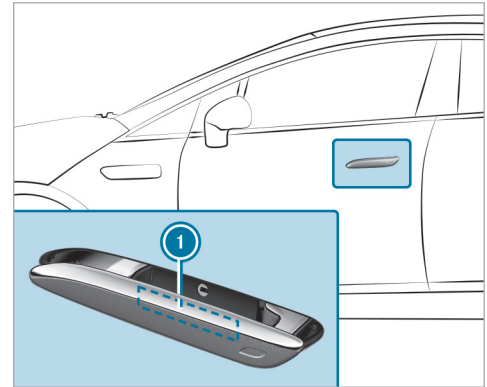

- ▶ **Unlocking the vehicle:** With the door handle extended, touch the inside surface ❶ of the door handle.

If the door handle is not extended, e. g. after a waiting period:

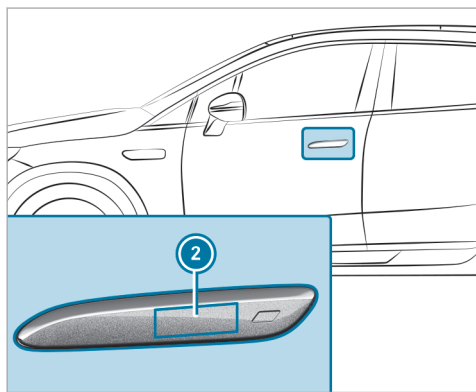

- ▶ Touch the sensor surface ❷ to unlock.

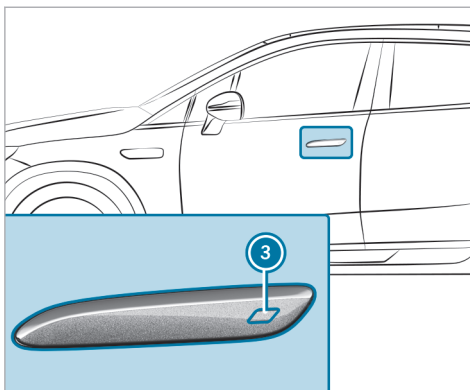

- ▶ **To lock the vehicle:** touch recessed sensor surface ❸.
- ▶ **Convenience closing:** touch recessed sensor surface ❸ for an extended period.
- ❶ Further information on convenience closing (→ page 102).

Problems with KEYLESS-GO, troubleshooting

You can no longer lock or unlock the vehicle using KEYLESS-GO

Possible causes:

- The function of the SmartKey has been deactivated.
 - The SmartKey battery is weak or discharged.
- ▶ Activate the function of the SmartKey (→ page 78).
 - ▶ Check the battery using the indicator lamp (→ page 77).
 - ▶ Replace the SmartKey battery, if necessary (→ page 79).
 - ▶ Use the replacement SmartKey.
 - ▶ Use the emergency key to lock or unlock (→ page 92).
 - ▶ Have the vehicle and SmartKey checked at a qualified specialist workshop.

There is interference from a powerful radio signal source

Possible causes if the function of KEYLESS-GO is impaired:

- High voltage power lines
- Mobile phones
- Electronic devices (notebooks, tablets)
- Shielding due to metal objects or induction loops for electrical gate systems or automatic barriers

- ▶ Make sure that there is sufficient distance between the SmartKey and the potential source of interference.

Activating or deactivating the automatic locking feature

Multimedia system:

→  ▶▶ Settings ▶▶ Vehicle
▶▶ Open/Close

- ⓘ The vehicle is locked automatically when the vehicle is switched on and the wheels are turning faster than walking pace.

- ▶ Activate or deactivate **Automatic Door Lock**.



In the following situations, there is a danger of being locked out when the function is activated:

- The vehicle is being towed or pushed.
- If the vehicle is being tested on a roller dynamometer.

Opening and closing the front convenience doors

⚠ WARNING Risk of becoming trapped during automatic closing of the front convenience doors

Parts of the body could become trapped. There may be people or animals in the closing area.

- ▶ Make sure that nobody is in the vicinity of the closing area.
- ▶ Use one of the following options to stop the closing process:
 - Press the  or  button on the SmartKey.
 - Driver's door: depress the brake pedal.

- Pull the inner or outer door handles.
- Push against or pull the door.
- Touch the touch screen in the convenience menu in the multimedia system.

! **NOTE** Always observe the following during automatic opening and closing of the front convenience doors

Your view of your surroundings may be restricted.

- ▶ Make sure that there are no persons, animals or objects in the area of the doors when opening and closing.
- ▶ When opening, pay particular attention to low objects and obstacles in the side window area.

Opening or closing the front convenience doors

The following functions are required to automatically open and close the front convenience doors:

- KEYLESS-GO (→ page 84)

- Power closing function (→ page 92)
 - Parking Package with 360° Camera (→ page 274)
- or
- Remote Parking Assist with Mirror Package (→ page 289)
 - Active Blind Spot Assist (→ page 264)

The convenience doors can then be opened and closed automatically.

- ❗ If Active Blind Spot Assist is deactivated or unavailable, the convenience doors cannot be opened from inside.

The following options are available for opening or closing the front convenience doors:



- the key (to open and close)
- approaching the vehicle (to open the driver's door)
- depressing the brake pedal (to close the driver's door)
- the inner front door handles (to open and close)

- the outer front door handles (to open and close)
- the multimedia system (→ page 91)

Special features of the front convenience doors:

- If, when closing, the front door has reached the first detent position, the power closing function (→ page 92) will automatically draw the door into the lock.

▶ **Open with the key** : Press and hold the  key button until the door starts to open.

- ❗ In the multimedia system, you can set whether the driver's door, the front passenger door or no door opens when you press the  button on the key (→ page 91). If no front door opens, the convenience opening function is carried out when the  button is pressed. The convenience opening function opens, for example, the side windows and the panoramic sliding sunroof. Further information on convenience opening (→ page 101).

▶ **To close with the key**: Press and hold the key button  until the door starts to close. Both open front doors close.

▶ **Comfort locking with the key**: Press and hold the key button . All open front doors, side windows and the panoramic sliding sunroof close.

- ❗ Press the  button on the key again to lock the vehicle.

To open the vehicle by approaching it:

❗ **NOTE** Vehicle damage due to unintentional opening of a door

- When passing the vehicle
- When using an automatic car wash
- When using a high-pressure cleaner

▶ In these situations, deactivate the function of the key.

When you approach your vehicle and the key is detected, the vehicle is unlocked and the driver's door opens automatically.

- ▶ Set the function in the multimedia system (→ page 91).

To close the driver's door with the brake pedal:

- ▶ Depress the brake pedal until the door starts to close.

To open or close the front convenience doors from inside:

- ▶ Briefly pull the door handle (→ page 83). Automatic operation is then started.
- ⓘ If you pull the door handle during automatic operation, the opening or closing process is stopped. If you pull the door handle again, the process continues in reverse order.
- ▶ **To open the front convenience doors from outside:** pull on the outside door handle.

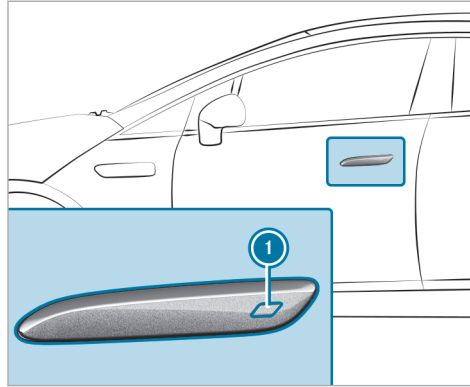

- ▶ **To close the front convenience doors from outside:** touch recessed sensor surface ① on the door handle.

Object detection

Object detection uses several sensors to monitor the opening range of the convenience doors in order to detect objects. If one of the sensors detects an object, the convenience doors are

stopped and a warning is displayed in the multimedia system.

- ▶ Manually open a door stopped in an intermediate position.

Even if the convenience doors are equipped with sensors, it cannot be guaranteed that all objects are detected. Object detection is only an aid and is not a substitute for the attention of the vehicle occupants to their immediate surroundings when opening and closing the convenience doors. The vehicle occupants are always responsible for opening and closing the doors safely.

Detection range of the sensors

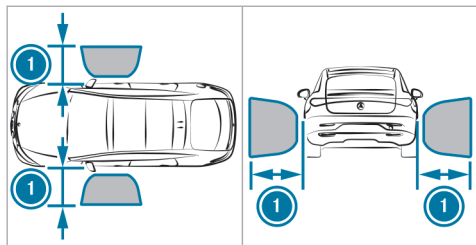

① 3 ft (approximately 1 m)

! **NOTE** Risk of an accident from objects at close range

Object recognition may not detect certain objects at close range.

- ▶ When opening the convenience doors, pay particular attention to low objects and obstacles in the side window area. Object detection does not always detect such objects at close range, especially during movement. The vehicle or other objects could otherwise be damaged.

! **NOTE** Risk of accident due to faulty sensors

The sensors may malfunction because of snow or due to objects that absorb ultrasonic waves.

- ▶ Make sure that the convenience doors are free from dirt, ice or slush.
- ▶ Be especially careful when opening the convenience doors if other ultrasonic sources are nearby.

! **NOTE** Risk of accidents if the detection performance of the sensors in the convenience doors is restricted

If the sensors are covered, the convenience doors cannot function reliably.

- ▶ Do not apply stickers, foils or other coatings to the outside of the convenience doors.
The sensors may otherwise be blocked and obstacles may not be detected or only detected to a limited extent.

Exit warning when opening the front doors from inside

The exit warning of Active Blind Spot Assist is used as an additional safeguard. If an obstacle is detected, the convenience function is deactivated and the moving door will be stopped.

- ▶ Manually open a door stopped in an intermediate position.

! **WARNING** Risk of accident despite exit warning

The exit warning neither reacts to stationary objects nor to persons or road users approaching you at a greatly differing speed. The exit warning cannot warn drivers in these situations.

- ▶ Always pay particular attention to the traffic situation when opening the doors and make sure there is sufficient clearance.

The exit warning is only an aid and not a substitute for the attention of vehicle occupants. The responsibility for opening and closing the doors

and for leaving the vehicle remains with the vehicle occupants.

- Further information on Active Blind Spot Assist with exit warning (→ page 264).

Blockage detection when opening the front doors

If an obstacle obstructs a door during the automatic opening process, blockage detection will stop the door. The automatic blockage detection function is only an aid and is not a substitute for your attentiveness.

- Manually open a door stopped in an intermediate position.

! **NOTE** Damage to the convenience doors despite blockage detection

Blockage detection may not be able to stop the automatic opening process of the doors in all cases. This can be the case in particular with light, soft objects.

- Therefore, make sure that there is sufficient clearance next to the vehicle.

Automatic backing up function when closing the front doors

The doors are equipped with automatic blockage detection with a backing up function. If an obstacle stops a door during the automatic closing process, it will automatically open again. The automatic backing up function is only an aid and is not a substitute for your attentiveness.

- During the closing process, make sure that no body parts are in the closing area.



! **WARNING** Risk of becoming trapped despite reversing function

The reversing function will not react:

- To soft, light and thin objects, e.g. fingers.
- Towards the end of the closing process.

In these situations in particular, the reversing function cannot prevent someone being trapped.

- Make sure that no body parts are in the closing area.
- If someone is trapped, use one of the following options:

- Press the  or  button on the SmartKey.
- Driver's door: depress the brake pedal.
- Pull the inner or outer door handles.
- Push against or pull the door.
- Touch the touch screen in the convenience menu in the multimedia system.

Setting comfort doors

Multimedia system:

  **» Settings » Vehicle » Comfort**

- Activate or deactivate **Comfort Doors**.

Operating comfort doors

- Select .
- Select **Open door control**.
The window for operating the doors will open. You can open and close the doors using the slider.

- ▶ Select **Cancel Process**.
The process will be canceled and the door will remain in the position it has reached.
- ▶ Select **Close All**.
All doors will be closed simultaneously.

Setting the key function for the comfort doors

- ▶ Select .
- ▶ Select **Key assignment**.
Convenience Opening for Windows, opening **Right Front Door** and opening **Left Front Door** can be set separately for operation with the key.

Door opening on approach

- ▶ Activate or deactivate the function.
When the function is activated, the driver's door will open automatically when you approach the vehicle.

Warning of obstacles in the door area

- ▶ Activate or deactivate the function.
The vehicle will warn you of obstacles in the door area with acoustic feedback and a graphical display.

Power closing function

⚠ WARNING Risk of becoming trapped when the doors close automatically

Body parts or objects can become trapped, causing injuries.

- ▶ Ensure that no body parts or objects are in the closing area.
- ▶ Automatic closing of the doors can be canceled by pulling the outer or inner door handle.

If you push the door into the lock to the first detent position, the power closing function will automatically pull the door into the lock.

- ⓘ Automatic closing of the doors may be triggered if the vehicle is locked from the outside, or during pulling away.

Locking/unlocking the vehicle with the mechanical key

Unlocking a left-hand vehicle door with the mechanical key

- ⓘ If you unlock and open the driver's door with the mechanical key, this triggers the burglar alarm system.
- ⓘ If you unlock the driver's door with the mechanical key, the tailgate will not be unlocked.

Vehicles without KEYLESS-GO

- ▶ Remove the mechanical key (→ page 79).

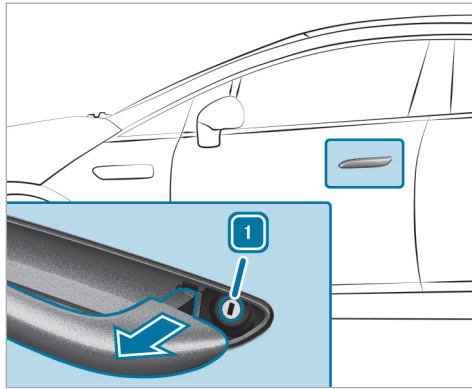

- ▶ Pull and hold the door handle.
- ▶ Insert the mechanical key into the lock cylinder.
- ▶ Turn the mechanical key counter-clockwise to position **1**.
- ▶ Turn the mechanical key back to its starting position.

- ▶ Remove the mechanical key and release the door handle.

Vehicles with KEYLESS-GO

- ▶ Remove the mechanical key (→ page 79).

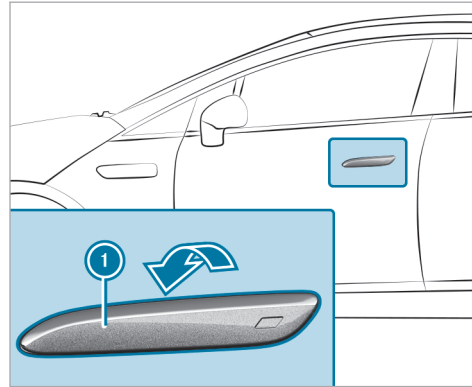

If the door handle is retracted:

- ▶ Insert a flat, non-metallic object behind door handle **1** from above and pry it slightly outward.
- ▶ Reach behind door handle **1** from below, pull it outward to the pressure point and hold it there.

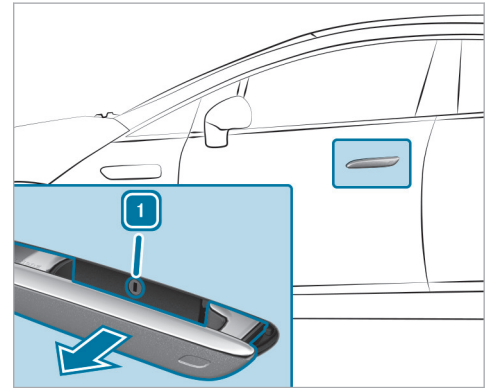

If the door handle is extended:

- ▶ Pull door handle ❶ outward to the pressure point and hold it there.
- ▶ Insert the mechanical key into the lock cylinder.
- ▶ Turn the mechanical key counter-clockwise to position ❶.
- ▶ Forcefully pull door handle ❶ outward past the pressure point.
- ▶ Turn the mechanical key back to its starting position.
- ▶ Remove the mechanical key and release the door handle.

Locking the doors

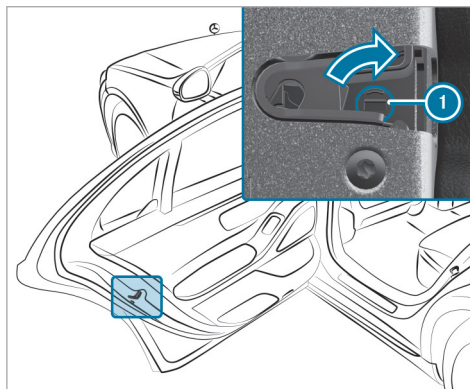

- ▶ Insert a suitable object, e.g. the mechanical key, into opening ❶ on the door lock.
- ▶ **To lock the left-hand side of the vehicle:** turn the mechanical key clockwise as far as it will go.

- ▶ **To lock the right-hand side of the vehicle:** turn the mechanical key counter-clockwise as far as it will go.

If the locked door is then closed, it can no longer be opened from the outside.

Cargo compartment

Opening the tailgate

! **NOTE** Damage to the tailgate caused by obstacles above the vehicle

The tailgate swings rearwards and upwards when it is opened.

- ▶ Make sure that there is sufficient space behind and above the tailgate.

- ▶ If the tailgate is unlocked, press the top of the Mercedes star.
- ▶ **Vehicles with HANDS-FREE ACCESS:** make a kicking movement with your foot below the bumper (→ page 97).

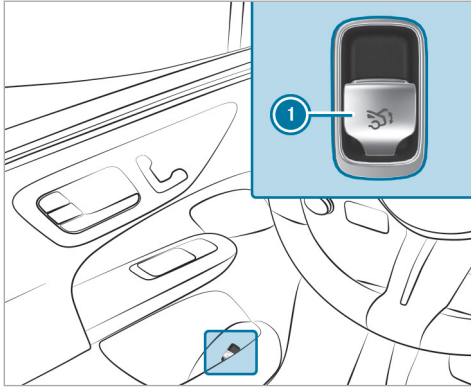

- ▶ Pull remote operating switch ❶ until the tailgate opens.
- or
- ▶ Press and hold the  button on the key.
 - ▶ If the tailgate has stopped in an intermediate position, pull it upwards. Release it as soon as it begins to open.

If an obstacle obstructs the tailgate during the automatic opening process, blockage detection will stop the tailgate. The automatic blockage detection function is only an aid. It is not a substitute for your attentiveness.

Closing the tailgate

⚠ WARNING Risk of injury from unsecured items in the vehicle

If objects, luggage or loads are not secured or not secured sufficiently, they could slip, tip over or be thrown around and thereby hit vehicle occupants.

There is a risk of injury, particularly in the event of sudden braking or a sudden change in direction.

- ▶ Always stow objects in such a way that they cannot be thrown around.
- ▶ Before the journey, secure objects, luggage or loads against slipping or tipping over.

Observe the notes on loading the vehicle.

Notes on closing the tailgate: your vehicle is equipped with automatic key recognition. If a key belonging to the vehicle is detected in the vehicle, the tailgate will not be locked.

Note that the tailgate will not be locked in the following situation:

- You have locked the vehicle and close the tailgate while a key belonging to the vehicle is inside the vehicle.
- and
- A second key belonging to the vehicle is not detected outside the vehicle.

Automatic key recognition is only an aid and is not a substitute for your attentiveness.

- ▶ Before locking, ensure that at least one key belonging to the vehicle is outside the vehicle.
- ▶ **To close the tailgate:** pull the tailgate downwards slightly. Release it as soon as it begins to close.

⚠ WARNING Risk of becoming trapped during automatic closing of the tailgate

Parts of the body could become trapped. There may be people in the closing area.

▶ Make sure that nobody is in the vicinity of the closing area.

Use one of the following options to stop the closing process:

- Press the  button on the SmartKey.
- Press or pull the remote operating switch on the driver's door.
- Press the closing or locking button on the tailgate.
- Press the top of the Mercedes star on the tailgate.

Vehicles with HANDS-FREE ACCESS: it is also possible to stop the closing process by making a kicking movement below the rear bumper.



- ▶ Switch on the power supply or the vehicle.
- ▶ Push remote operating switch ① until the tailgate is fully closed.

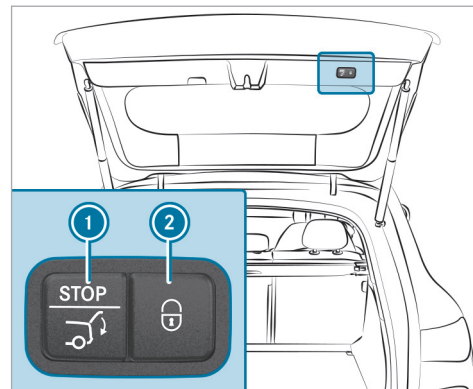

- ▶ Press closing button ① on the tailgate.

Vehicles with KEYLESS-GO

- ▶ Press locking button ② on the tailgate. If a key is detected outside the vehicle, the tailgate will close and the vehicle will be locked.

i Vehicles with Digital Vehicle Key: this also applies to the Digital Vehicle Key if the function is activated and the Digital Vehicle Key is connected to the vehicle.

- ▶ Press and hold the  button on the key. The key must be in the vicinity of the vehicle.

Vehicles with HANDS-FREE ACCESS

- ▶ Make a kicking movement with your foot below the bumper (→ page 97).

Automatic reversing function for the tailgate

The tailgate is equipped with automatic blockage detection with a reversing function. If an obstacle obstructs the tailgate during the automatic closing process, it will automatically open again slightly. Automatic blockage detection with the reversing function is only an aid and is not a substitute for your attentiveness.

- ▶ During the closing process, make sure that no body parts are in the closing area.

⚠ WARNING Risk of becoming trapped despite reversing function

The reversing function will not react:

- To soft, light and thin objects, e.g. fingers.
- Towards the end of the closing procedure.

In these situations in particular, the reversing function cannot prevent someone being trapped.

- ▶ Make sure that no body parts are in the closing area.

If someone is trapped, either:

- Press the  button on the SmartKey.
- Press or pull the remote operating switch on the driver's door.
- Press the closing or locking button on the tailgate.
- Press the top of the Mercedes star on the tailgate.

HANDS-FREE ACCESS function

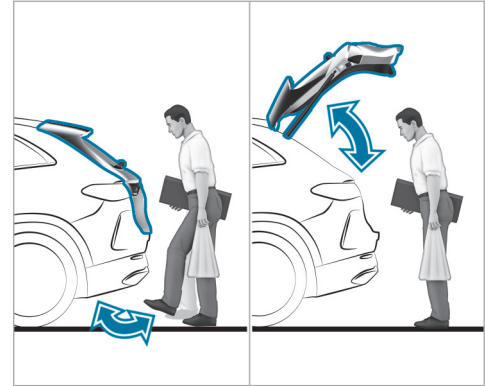

With HANDS-FREE ACCESS you can open, close or stop the closing process of the tailgate by performing a kicking movement under the rear bumper.

The kicking movement triggers the opening or closing process alternately.

Observe the notes when opening (→ page 94) and closing (→ page 95) the tailgate.

- i** Two warning tones sound when the tailgate is opening or closing.

! **NOTE** Vehicle damage due to unintentional opening of the tailgate or a door

- When using an automatic car wash
- When using a high pressure cleaner

▶ Deactivate the function of the SmartKey in these situations.

or

▶ Make sure that the SmartKey is at a minimum distance of 10 ft (3 m) (power washer) or 20 ft (6 m) (automatic car wash) away from the vehicle.

Vehicles with digital vehicle key:

! **NOTE** Vehicle damage due to unintentional opening of the tailgate or a door

- when using an automatic car wash
- when using a power washer

▶ In these situations, switch off the Digital Vehicle Key.

or

▶ Make sure that the Digital Vehicle Key is at least 10 ft (3 m) (power washer) or 20 ft (6 m) (car wash) away from the vehicle.

When making the kicking movement, make sure that you are standing firmly on the ground. You could otherwise lose your balance, e.g. on ice.

Observe the following notes:

- The key is behind the vehicle.
- **Vehicles with digital vehicle key:** The Digital Vehicle Key is behind the vehicle.
- Stand at least 12 in (30 cm) away from the vehicle while performing the kicking movement.
- Do not come into contact with the bumper while making the kicking movement.
- Do not carry out the kicking movement too slowly.

- The kicking movement must be towards the vehicle and back again.

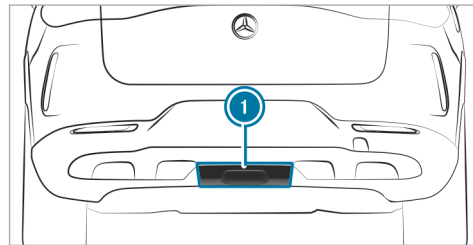

- 1** Detection range of the sensors

If several consecutive kicking movements are not successful, wait ten seconds.

System limits

The system may be impaired or may not function in the following cases:

- The sensors are dirty, e.g. due to road salt or snow.
- The kicking movement is made using a prosthetic leg.

The tailgate can open or close unintentionally in the following situations:

- A person's arms or legs are moving in the sensor detection range, e.g. when polishing the vehicle or picking up objects.
- Objects are moved or placed behind the vehicle, e.g. a charging cable or luggage.
- Clamping straps, tarp or other coverings are pulled over the bumper.
- A protective mat with a length reaching over the trunk sill down into the detection range of the sensors is used.
- The protective mat is not secured correctly.
- Work is being done on the trailer hitch, trailers or rear bicycle racks.

Deactivate the function of the key (→ page 78) or do not carry the key about your person in such situations.

Limiting the opening angle of the tailgate

Activating the opening angle limiter

You can limit the opening angle of the tailgate in the top half of its opening range up to a point shortly before the end position.

- ▶ Stop the opening procedure of the tailgate at the desired position.
- ▶ Press and hold the closing button on the tailgate until you hear a short acoustic signal. The opening angle limiter will be activated. The tailgate will then stop in the stored position when opened.

To open the tailgate fully, pull the top part of the Mercedes star on the tailgate again after it has stopped automatically.

Deactivating the opening angle limiter

- ▶ Press and hold the closing button on the tailgate until two short acoustic signals sound.

Unlocking the tailgate with the emergency key

Requirements

- The rear seat backrest has been folded forward.
- The cargo compartment cover has been removed.

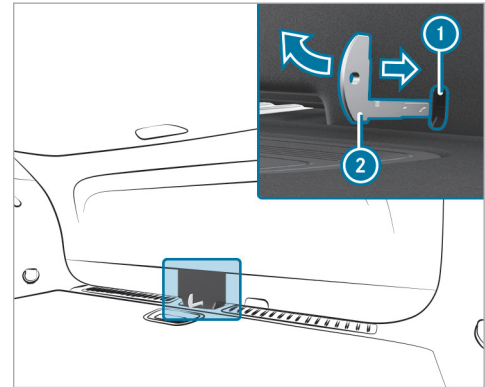

- ▶ Remove the emergency key (→ page 79).

- ▶ Insert emergency key ② into opening ① in the trim and push it in the direction of the arrow.
The tailgate will be unlocked.

Side windows

Opening and closing the side windows

⚠ WARNING Risk of entrapment when opening a side window

When opening a side window, parts of the body could be drawn in or become trapped between the side window and window frame.

- ▶ When opening, make sure that nobody is touching the side window.
- ▶ If someone is trapped, release the button immediately or pull it in order to close the side window again.

⚠ WARNING Risk of becoming trapped when closing a side window

When closing a side window, body parts could be trapped in the closing area in the process.

- ▶ When closing, make sure that no body parts are in the closing area.
- ▶ If someone is trapped, release the button immediately or press the button in order to reopen the side window.

⚠ WARNING Risk of becoming trapped when children operate the side windows

Children could become trapped if they operate the side windows, particularly when unattended.

- ▶ Activate the child safety lock for the rear passenger compartment side windows.
- ▶ When leaving the vehicle, always take the SmartKey with you and lock the vehicle.
- ▶ Never leave children unattended in the vehicle.

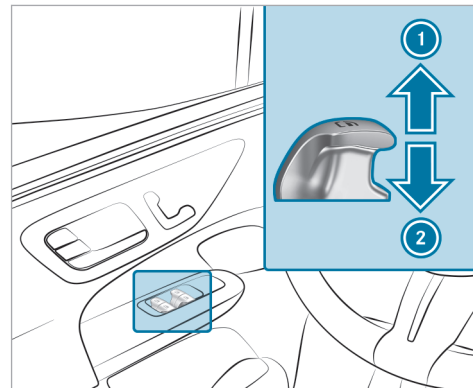

Requirements

- The power supply or the vehicle has been switched on.



- ① Closing
- ② Opening

The buttons on the driver's door take precedence.

- ▶ **To start automatic operation:** press the  button beyond the point of resistance or pull and release it.
- ▶ **To interrupt automatic operation:** press or pull the  button again.

When the vehicle is switched off, you can continue to operate the side windows.

This function is available for around four minutes or until a front door is opened.

Automatic reversing function of the side windows

If an obstacle impedes a side window during the closing process, the side window will open again automatically. The automatic reversing function is only an aid and is not a substitute for your attentiveness.

- ▶ During the closing process, make sure that no body parts are in the closing area.

⚠ WARNING Risk of becoming trapped despite there being reversing protection on the side window

The reversing function does not react:

- To soft, light and thin objects, e.g. fingers.
- During resetting.

The reversing function cannot prevent someone from becoming trapped in these situations.

- ▶ During the closing process, make sure that no body parts are in the closing area.
- ▶ If someone becomes trapped, press the  button to open the side window again.

Convenience opening (ventilating the vehicle before starting a journey)

⚠ WARNING Risk of entrapment when opening a side window

When opening a side window, parts of the body could be drawn in or become trapped between the side window and window frame.

- ▶ When opening, make sure that nobody is touching the side window.
- ▶ Release the button immediately if somebody becomes trapped.

Requirements

- The SmartKey is in the immediate vicinity of the vehicle.
- ▶ Press and hold the  button on the SmartKey.
- The following functions are performed:
- The vehicle is unlocked.
 - The side windows are opened.
 - The panoramic sliding roof is opened.

- The seat ventilation of the driver's seat is switched on.

i If the roller sunblind of the panoramic sliding sunroof is closed, the roller sunblind is opened first.

▶ **To interrupt convenience opening:** release the  button.

▶ **To continue convenience opening:** press and hold the  button again.

Convenience closing (closing the vehicle from outside)

▲ WARNING Risk of entrapment due to not paying attention during convenience closing

When the convenience closing feature is operating, parts of the body could become trapped in the closing area of the side window and the sliding sunroof.

- ▶ When the convenience closing feature is operating, monitor the entire closing

process and make sure that no body parts are in the closing area.

Requirements

- The key is in the immediate vicinity of the vehicle.

▶ Press and hold the  button on the key.

The following functions will be performed:

- The vehicle will be locked.
- The side windows will be closed.
- The panoramic sliding roof will be closed.

▶ **To interrupt convenience closing:** release the  button.

▶ **To continue convenience closing:** press and hold the  button again.

i Convenience closing also functions with KEYLESS-GO (→ page 84).

Resolving problems with the side windows

▲ WARNING Risk of becoming trapped or fatally injured if reversing protection is not activated

If you close a side window again immediately after it has been blocked, the side window will close with increased or maximum force. The reversing function is then not active and body parts may become trapped.

- ▶ Make sure that no parts of the body are in the closing area.
- ▶ To stop the closing process, release the button or press the button again to reopen the side window.

A side window cannot be closed and you cannot see the cause.

- ▶ Check to see whether any objects are in the window guide.
- ▶ Adjust the side windows.

Adjusting the side windows

If a side window is obstructed during closing and reopens again immediately:

- ▶ Immediately after this, pull and hold the corresponding button again until the side window has closed and hold the button for at least one more second (re-adjustment).
The side window will be closed without the automatic reversing function.

If the side window is obstructed again and reopens again immediately:

- ▶ Immediately after this, pull and hold the corresponding button again until the side window has closed and hold the button for at least one more second (follow-up adjustment).
The side window will be closed without the automatic reversing function.

The side windows cannot be opened or closed using the convenience opening feature.

Possible causes:

- The key battery is weak or discharged.
- ▶ Check the battery using the indicator lamp (→ page 77).

- ▶ Replace the key battery, if necessary (→ page 79).

Sliding sunroof

Opening and closing the sliding sunroof

- ⓘ The term "sliding sunroof" refers to the panorama roof with power tilt/sliding panel.

⚠ WARNING Risk of becoming trapped when the sliding sunroof is being opened and closed

Body parts may become trapped in the range of movement.

- ▶ During the opening and closing process, make sure that no body parts are in the sweep of the sliding sunroof.
- ▶ If someone is trapped, release the control panel immediately.

or

- ▶ Touch the control panel during automatic operation.
The opening/closing process will be stopped.

⚠ WARNING Risk of becoming trapped if the sliding sunroof is operated by children

Children operating the sliding sunroof could get caught in the moving parts, particularly if unattended.

- ▶ Never leave children unattended in the vehicle.
- ▶ When leaving the vehicle, always take the key with you and lock the vehicle.

⚠ WARNING Risk of becoming trapped when the roller sunblind is being opened and closed

Body parts may become trapped between the roller sunblind and frame or sliding roof.

- ▶ During the opening or closing process, make sure that no body parts are in the roller sunblind's range of movement.
- ▶ If someone is trapped, release the control panel immediately.

or

- ▶ Touch the control panel during automatic operation. The opening/closing process will be stopped.

! **NOTE** Malfunction due to snow and ice

Snow and ice may cause the sliding sunroof to malfunction.

- ▶ Open the sliding sunroof only if it is free of snow and ice.

! **NOTE** Damage caused by protruding objects

Objects that protrude from the sliding sunroof may damage the seals.

- ▶ Do not allow anything to protrude from the sliding sunroof.

! **NOTE** Damage to panorama roof with power tilt/sliding panel caused by roof luggage rack

If the panorama roof with power tilt/sliding panel is opened when a roof luggage rack is installed, the panorama roof with power tilt/sliding panel may be damaged by the roof luggage rack.

- ▶ Do not open the panorama roof with power tilt/sliding panel if a roof luggage rack is installed.

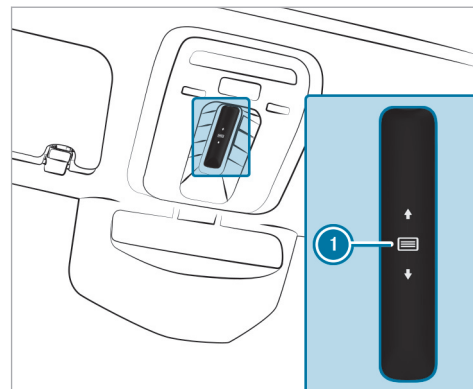

The sliding sunroof and the roller sunblind are operated using control panel ①.

The panorama roof with power tilt/sliding panel can be operated only when the roller sunblind is open. **Exception:** Ventilating the vehicle interior

- ▶ **To open:** swipe backwards across control panel ① and hold.

- ▶ **To close:** swipe forwards across control panel ① and hold.
- ▶ **To ventilate the vehicle interior:** briefly press control panel ① when the roller sunblind is closed.
The sliding sunroof raises and the roller sunblind opens slightly.
- ▶ **To lower:** briefly press control panel ①.
The sliding sunroof is closed.
- ▶ **To close the roller sunblind:** swipe forwards across control panel ①.
- ▶ **To start automatic operation:** swipe forwards or backwards across control panel ①.
- ▶ **To cancel automatic operation:** press control panel ① again.
The opening/closing process will be stopped.

Automatic reversing function of the sliding sunroof

If an obstacle obstructs the sliding sunroof during the closing process, the sliding sunroof will open again automatically. The automatic reversing function is only an aid and is not a substitute for your attentiveness.

- ▶ During the closing process, make sure that no body parts are in the closing area.

⚠ WARNING Risk of becoming trapped despite reversing function

The reversing function will not react:

- To soft, light and thin objects, e.g. fingers.
- Towards the end of the closing procedure.
- During resetting.

▶ During the closing process, make sure that no body parts are in the closing area.

▶ If someone is trapped, release the control panel immediately.

or

▶ Touch the control panel during automatic closing.
The closing process will be stopped.

Automatic reversing function of the roller sunblind

If an obstacle obstructs the roller sunblind during the closing process, the roller sunblind will open again automatically. The automatic reversing func-

tion is only an aid and is not a substitute for your attentiveness.

- ▶ When closing the roller sunblind, make sure that no body parts are in the range of movement.

⚠ WARNING Risk of becoming trapped despite reversing function

In particular, the reversing function does not react to soft, light and thin objects, e.g. fingers.

▶ When closing the roller sunblind, make sure that no body parts are in the range of movement.

▶ If someone is trapped, release the control panel immediately.

or

▶ Touch the control panel during automatic closing.
The closing process will be stopped.

Automatic functions of the sliding sunroof

- ① The term "sliding sunroof" refers to the panorama roof with power tilt/sliding panel.

Rain closing function when driving

Vehicles with a panorama roof with power tilt/sliding panel: if it starts to rain, the raised sliding sunroof will automatically be lowered while the vehicle is in motion.

Automatic lowering function

Vehicles with a panorama roof with power tilt/sliding panel: if the sliding sunroof is raised at the rear, it will automatically be lowered slightly at higher speeds. At low speeds, it will be raised again automatically.

⚠ WARNING Risk of becoming trapped by automatic lowering of the sliding sunroof

At higher speeds, the raised sliding sunroof will automatically be lowered slightly at the rear.

- ▶ Make sure that nobody reaches into the sliding sunroof's range of movement while the vehicle is in motion.
- ▶ If someone becomes trapped, touch the control panel.

Rectifying problems with the sliding sunroof

⚠ WARNING Risk of becoming trapped or fatal injuries when the sliding sunroof is closed again

If you close the sliding sunroof again immediately after it has been blocked or reset, the sliding sunroof will close with increased or maximum force.

There is a risk of becoming trapped or even of fatal injuries!

- ▶ Make sure that no parts of the body are in the closing area.
- ▶ If someone is trapped, release the control panel immediately.

or

- ▶ Touch the control panel during automatic closing.
The closing process will be stopped.

The sliding sunroof cannot be closed and you cannot see the cause.

- ① The term "sliding sunroof" refers to the panorama roof with power tilt/sliding panel.

If the sliding sunroof is obstructed during closing and reopens again slightly:

- ▶ Immediately after automatic reversing, swipe forwards across the control panel (→ page 103) and hold until the sliding sunroof is closed.
The sliding sunroof will be closed with increased force.

If the sliding sunroof is obstructed again and opens again slightly:

- ▶ Repeat the previous step.
The sliding sunroof will be closed again with increased force.

The sliding sunroof or the roller sunblind is not operating smoothly.

- ▶ Reset the sliding sunroof and the roller sunblind.

Resetting the sliding sunroof and the roller sunblind

- ▶ Swipe forwards across the control panel (→ page 103) and hold repeatedly until the sliding sunroof is completely closed.
- ▶ Press and hold the control panel for another second.
- ▶ Press and hold the control panel until the front roller sunblind is completely closed.
- ▶ Press and hold the control panel for another second.
- ▶ Use automatic operation to fully open and then close the sliding sunroof.

Anti-theft protection

Function of the immobilizer

The immobilizer prevents your vehicle from being started without the correct key.

This also applies to the Digital Vehicle Key.

The immobilizer will automatically be activated when the vehicle is switched off, and deactivated when the vehicle is switched on.

When leaving the vehicle, always take the key with you and lock the vehicle. Anyone can start the vehicle if a valid key has been left inside the vehicle.

- ⓘ In the event that the engine cannot be started (yet the vehicle's battery is charged), the system will not be operational. Contact an authorized Mercedes-Benz center or call 1-800-FOR-MERCEDES (in the USA) or 1-800-387-0100 (in Canada).

ATA (anti-theft alarm system)

Function of the ATA system

If the ATA system is armed, a visual and audible alarm will be triggered in the following situations:

- when a door is opened
- when the tailgate is opened
- when interior protection is triggered (→ page 109)
- when the tow-away alarm is triggered (→ page 108)

- ⓘ **Vehicles with Digital Vehicle Key:** The EDW works with the Digital Vehicle Key in the same way as with the conventional vehicle key.

The ATA system will be armed automatically after approximately ten seconds in the following situations:

- after the vehicle is locked with the key
- after the vehicle is locked using KEYLESS-GO
- After the vehicle is locked with the NFC function (**vehicles with digital vehicle key:**)

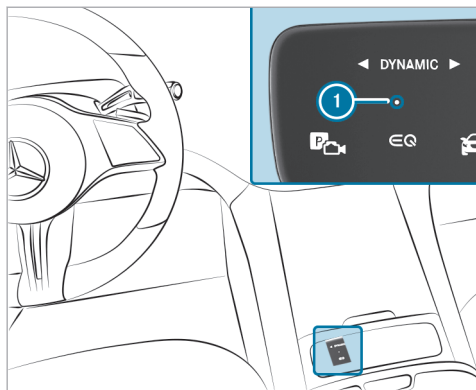

Example: with MBUX hyperscreen

Indicator lamp ❶ will flash when the ATA system is armed.

The ATA system will be deactivated automatically in the following situations:

- after the vehicle is unlocked with the key
- after the vehicle is unlocked using KEYLESS-GO

- after the vehicle is unlocked with the NFC function (**vehicles with digital vehicle key:**)
- after the start/stop button is pressed with the key in the stowage compartment (→ page 184)

Deactivating the ATA

▶ Press the , or button on the key.

or

▶ Press the start/stop button with the key in the stowage compartment (→ page 184)

▶ **Vehicles with digital vehicle key:** Press the start/stop button with the digital vehicle key in the storage compartment (→ page 183).

Deactivating the alarm using KEYLESS-GO

▶ With the key outside the vehicle, touch the inner surface of the door handle. This also applies to the Digital Vehicle Key.

Function of the tow-away alarm

❶ This function may not be available in all countries.

An audible and visual alarm will be triggered if an alteration to your vehicle's angle of inclination is detected while the tow-away alarm is armed.

The tow-away alarm will automatically be armed after approximately 60 seconds:

- after the vehicle is locked with the key
- after the vehicle is locked using KEYLESS-GO This also applies to the Digital Vehicle Key.
- After the vehicle is locked with the NFC function (**vehicles with digital vehicle key:**)

The tow-away alarm will be armed only when the following components are closed:

- Doors
- Tailgate

The tow-away alarm will automatically be deactivated:

- after the or button on the key is pressed
- after the start/stop button is pressed with the key in the stowage compartment (→ page 184)

- after the start-stop button is pressed with the digital vehicle key in the storage compartment (**Vehicles with digital vehicle key**) (→ page 183)
- after the vehicle is unlocked using KEYLESS-GO
This also applies to the Digital Vehicle Key.
- after the vehicle is unlocked with the NFC function (**vehicles with digital vehicle key:**)
- when HANDS-FREE ACCESS is used

Information on collision detection on a parked vehicle (→ page 223).

Arming/deactivating tow-away alarm

Multimedia system:

-  » Settings » Vehicle
- » Opening/closing » Vehicle Protection
- ▶ Arm or deactivate **Tow-away Protection**.

Tow-away alarm is armed again in the following cases:

- The vehicle is unlocked again.

- A door is opened.
- The vehicle is locked again.

Function of interior protection

- ⓘ This function may not be available in all countries.

When interior protection is armed, a visual and audible alarm is triggered if movement is detected in the vehicle interior.



Interior protection is armed automatically after approximately ten seconds:

- after locking the vehicle with the key
- after locking the vehicle using KEYLESS-GO
This also applies to the Digital Vehicle Key.
- After locking with the NFC function (**vehicles with digital vehicle key:**)

Interior protection is armed only when the following components are closed:

- Doors
- Tailgate

Interior protection is automatically deactivated:

- after pressing the  or  button on the key
- after pressing the start/stop button with the key in the stowage compartment (→ page 184)
- after pressing the start-stop button with the digital vehicle key in the storage compartment (**Vehicles with digital vehicle key**) (→ page 183)
- after unlocking the vehicle using KEYLESS-GO
This also applies to the Digital Vehicle Key.
- after unlocking with the NFC function (**vehicles with digital vehicle key:**)
- when using HANDS-FREE ACCESS

The following situations can lead to a false alarm:

- when there are moving objects such as mascots in the vehicle interior
- if a side window is open
- if the panorama roof with power tilt/sliding panel is open

Arming/deactivating interior protection

Multimedia system:

↳  » Settings » Vehicle

» Opening/closing » Vehicle Protection

▶ Arm or deactivate [Interior Motion Sensor](#).

Interior protection is armed again in the following cases:

- The vehicle is unlocked again.
- A door is opened.
- The vehicle is locked again.

Notes on the correct driver's seat position

⚠ WARNING Risk of accident due to adjusting the vehicle settings while the vehicle is in motion

You could lose control of the vehicle in the following situations in particular:

- If you adjust the driver's seat, the head restraint, the steering wheel or the mirror while the vehicle is in motion
 - If you fasten your seat belt while the vehicle is in motion
- ▶ Before starting the vehicle: in particular, adjust the driver's seat, head restraint, steering wheel and mirror, and fasten your seat belt.

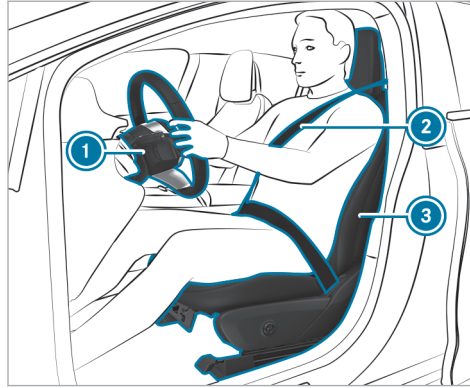

Ensure the following when adjusting steering wheel ①, seat belt ② and driver's seat ③:

- You are sitting as far away from the driver's air bag as possible, taking the following points into consideration:
- You are sitting in an upright position
- Your thighs are slightly supported by the seat cushion

- Your legs are not fully extended and you can depress the pedals properly
- The back of your head is supported at eye level by the center of the head restraint
- You can hold the steering wheel with your arms slightly bent
- You can move your legs freely
- You can see all the displays on the driver's display clearly
- You have a good overview of the traffic conditions
- Observe the notes on correctly fastening the seat belt (→ page 46).

Notes on grab handles

⚠ WARNING Risk of injury due to excessive load on the grab handles

If you apply your full body weight to the grab handle or pull it abruptly, the grab handle may be damaged or come loose from its anchorage. This may result in injuries.

- ▶ Use the grab handles only to stabilize the seating position or to assist in getting in and out of the seat.

Seats

Adjusting the front seat electrically

- ⚠ **WARNING** Risk of becoming trapped if the seats are adjusted by children

Children could become trapped if they adjust the seats, particularly when unattended.

- ▶ When leaving the vehicle, always take the SmartKey with you and lock the vehicle.
- ▶ Never leave children unattended in the vehicle.

You can adjust the seats when the vehicle is switched off.

- ⚠ **WARNING** Risk of becoming trapped when adjusting the seat

When you adjust a seat, you or other vehicle occupants could become trapped, e.g. on the seat guide rail.

- ▶ When adjusting a seat, make sure that no one has any part of their body within the sweep of the seat.

Observe the safety notes on "Airbags" and "Children in the vehicle".

- ⚠ **WARNING** Risk of accident due to adjusting the vehicle settings while the vehicle is in motion

You could lose control of the vehicle in the following situations in particular:

- If you adjust the driver's seat, the head restraint, the steering wheel or the mirror while the vehicle is in motion
- If you fasten your seat belt while the vehicle is in motion

- ▶ Before starting the vehicle: in particular, adjust the driver's seat, head restraint, steering wheel and mirror, and fasten your seat belt.

- ⚠ **WARNING** Risk of becoming trapped if the seat height is adjusted carelessly

If you adjust the seat height carelessly, you or other vehicle occupants could be trapped and thereby injured.

Children in particular could accidentally press the electrical seat adjustment buttons and become trapped.

- ▶ While moving the seats, make sure that hands or other body parts do not get under the lever assembly of the seat adjustment system.

▲ WARNING Risk of injury due to head restraints not being installed or being adjusted incorrectly

If head restraints have not been installed or have not been adjusted correctly, there is an increased risk of injury in the head and neck area, e.g. in the event of an accident or when braking.

- ▶ Always drive with the head restraints installed.
- ▶ Before driving off, make sure for every vehicle occupant that the center of the head restraint supports the back of the head at about eye level.

Adjust the head restraint fore-and-aft position so that it is as close as possible to the back of your head.

▲ WARNING Risk of injury or death due to an incorrect seat position

The seat belt does not offer the intended level of protection if you have not moved the seat backrest to an almost vertical position.

In particular, you could slip beneath the seat-belt and become injured.

- ▶ Adjust the seat properly before beginning your journey.
- ▶ Always ensure that the seat backrest is in an almost vertical position and that the shoulder belt is routed across the center of your shoulder.

▲ WARNING Risk of potentially fatal injuries due to objects trapped under the front passenger seat

Objects trapped under the front passenger seat may interfere with the function of the automatic front passenger air bag shutoff or damage the system.

- ▶ Do not stow any objects under the front passenger seat.
- ▶ When the front passenger seat is occupied, ensure that no objects have become trapped beneath the front passenger seat.

! NOTE Damage to the seats when adjusting

The seats may be damaged by objects when adjusting the seats.

- ▶ When adjusting the seats, make sure that there are no objects in the footwell, under or behind the seats.

The switches for adjusting the seats do not move. You will therefore receive no direct feedback on the switch while pressing the switch. Feedback is provided only by the movement of the seat.

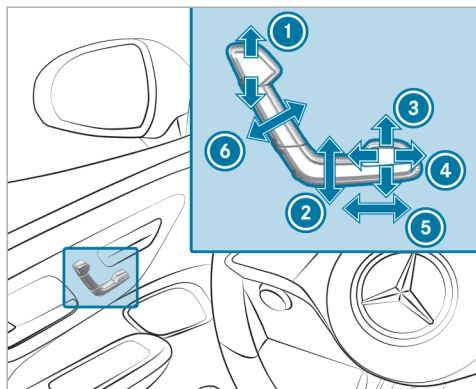

- ① Head restraint height
- ② Seat height
- ③ Seat cushion inclination
- ④ Seat cushion length
- ⑤ Seat fore-and-aft position
- ⑥ Seat backrest inclination

▶ Save the settings with the memory function (→ page 124).

① The head restraint height will be adjusted automatically when you adjust the seat height or the seat fore-and-aft position.

Adjusting the 4-way lumbar support

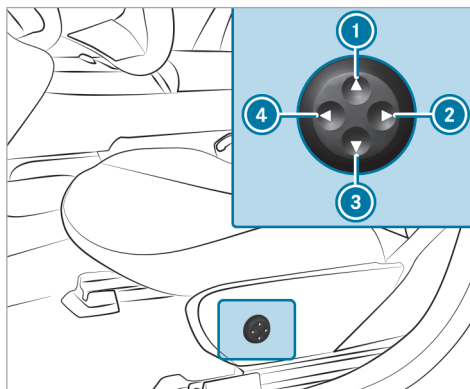

- ① Higher
- ② Softer
- ③ Lower
- ④ Firmer

- ③ Lower
- ④ Firmer

▶ Use buttons ① to ④ to adjust the contour of the backrest.

Head restraints

Adjusting the head restraints on the front seats

⚠ WARNING Risk of accident due to adjusting the vehicle settings while the vehicle is in motion

You could lose control of the vehicle in the following situations in particular:

- If you adjust the driver's seat, the head restraint, the steering wheel or the mirror while the vehicle is in motion
- If you fasten your seat belt while the vehicle is in motion

▶ Before starting the vehicle: in particular, adjust the driver's seat, head restraint,

steering wheel and mirror, and fasten your seat belt.

⚠ WARNING Risk of injury due to incorrectly adjusted head restraints

If head restraints have not been adjusted correctly, there is an increased risk of injury in the head and neck area, e.g. in the event of an accident or sudden braking.

- ▶ Before driving off, make sure for every vehicle occupant that the center of the head restraint supports the back of the head at about eye level.

Adjust the head restraint fore-and-aft position so that it is as close as possible to the back of your head.

Moving forward or back

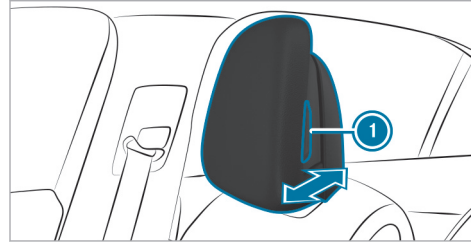

- ▶ Take hold of the head restraint on both sides and press release knob ①.
- ▶ Pull the head restraint forwards or push it backwards.
- ▶ Let go of release knob ①.
- ▶ **To raise or lower:** adjust the head restraint using the buttons on the door operating unit (→ page 112).

Adjusting the head restraints of the rear seats manually

- ① Move all head restraints up at least to the first detent, even in the steeper seating position

(cargo position) (→ page 131). If a head restraint is in the lowest, non-locked position, the respective seat must not be used.

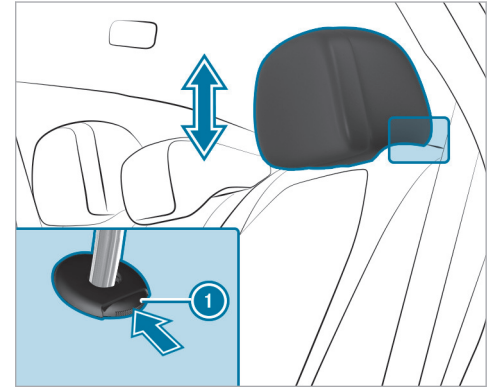

- ▶ **To raise:** push release knob ① in the direction of the arrow and pull the head restraint up until it engages.

- ▶ **To lower:** press release knob ① in the direction of the arrow and push the head restraint down until it engages.
- ▶ **If the center seat of the second row of seats is occupied:** pull the center head restraint up and engage it before starting the journey.

■ Installing/removing the rear seat head restraints

Removing

Depending on the vehicle equipment, you can remove the head restraints in the rear passenger compartment.

- ▶ Release the rear seat backrest and fold it forwards slightly (→ page 128).

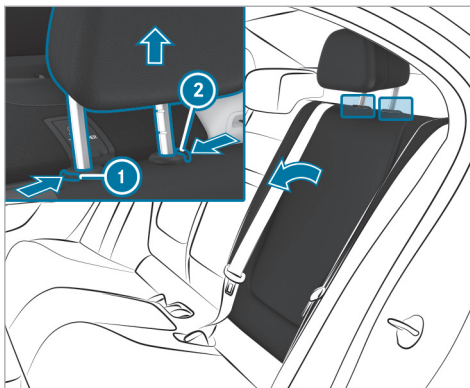

- ▶ Press release knobs ① and ② and pull out the head restraint.

Installing

- ▶ Insert the head restraint such that the notches on the bar are on the left when viewed in the direction of travel.
- ▶ Press release knobs ① and ②.
- ▶ Push the head restraint down until it engages.

- ▶ Fold the rear seat backrest back until it engages.

Configuring the seat settings

Multimedia system:

→ ▶▶ Comfort ▶▶ Seat

Adjusting the air cushions

- ▶ On the corresponding menu, adjust the air cushions for **Lumbar**, **Shoulders** or **Side Bolsters**.

Setting the seat heating balance

- ▶ Select **Heating Settings**.
- ▶ Select **Seat Heating Balance**.
- ▶ Adjust the heat distribution for the desired seat.

Setting automatic seat adjustment

⚠ WARNING Risk of becoming trapped during adjustment of the driver's seat after calling up a driver profile

Selecting a user profile may trigger an adjustment of the driver's seat to the position saved under the user profile. You or other vehicle occupants could be injured in the process.

▶ Make sure that when the position of driver's seat is being adjusted using the multimedia system, no people or body parts are in the seat's range of movement.

If there is a risk of someone becoming trapped, immediately stop the adjustment process by:

▶ a) Pressing the warning message on the central display.

or

▶ b) Pressing a position button of the memory function or a seat adjustment switch in the driver's door.
The adjustment process is stopped.

Multimedia system:

→  ▶▶ Comfort ▶▶ Seat
▶▶ Automatic Seat Positioning

Manually adjusting driver's seat and steering wheel position to body size

The vehicle calculates a suitable driver's seat and steering wheel position on the basis of the driver's body size and sets this directly.

▶ **To set the unit of measurement:** select **cm** or **ft/in**.

▶ Set the size using the scale.

▶ Select **Start Positioning**.

The driver's seat and steering wheel position is adjusted to the body size that has been set.

i You can also configure these settings via the Mercedes me user account for your user profile. By synchronizing the profiles in the vehicle and the Mercedes me connect profiles, you can carry over these settings for your vehicle. Further information about synchronizing user profiles .

i If the driver's seat and steering wheel position calculated by the vehicle is not practical or

comfortable, it can be manually adapted at any time via the control buttons.

The outside mirrors are not set via this function. Instead, they have to be set manually via the operating switches.

Overview of massage programs

- **Classic Massage** Relaxing back massage.
- **Mobilizing Massage** Mobilizing massage with upward-moving relaxing waves. Can promote slower, deeper respiration. This can improve the supply of oxygen to cells and the brain.
- **Activating Massage** Activating massage with upward-moving relaxing waves.
- **Hot Relaxing Back:** Based on hot stone massage, the program combines heat and massage. It starts by massaging the back. In addition, warm pressure points become noticeable, starting in the pelvic area.
- **Hot Relaxing Shoulders** Combination of heat and massage. It starts by massaging the shoulders. In addition, warm pressure points become noticeable, starting in the pelvic area.

- **Wave Massage** Regenerating massage via soothing waves across the back and in the seat cushion.
- **Deep Waves:** Wave-like movements in the cushion can promote blood flow and metabolic processes in the lower back and legs.
- **Deep Workout:** Combines the **Workout, Backrest** with the **Workout, Cushion**. The vibrations in the cushion intensify the effectiveness of tensing and releasing muscles when you tense against the pressure point. This supports metabolic processes and blood flow in the buttocks and legs.
- **Workout, Backrest** and **Workout, Cushion** These programs require your cooperation. Alternating between tensing and releasing helps to improve blood flow to your muscles. Press against a pressure point as soon as you feel it to activate back, abdominal and leg muscles.

Selecting a massage program for the front seats

Multimedia system:

Comfort **»** **Massage**

- ▶ Select a massage program (→ page 117).
- ▶ Start the program for the desired seat .
- ▶ **To set the massage intensity:** switch **Intensive** on or off .

The availability of this function is dependent on the vehicle's equipment.

Resetting seat settings

Multimedia system:

Comfort **»** **Seat**

- ▶ Select **Reset**.
- ▶ Select for the desired seat.

Switching the seat heating on/off

WARNING Risk of burns due to repeatedly switching on the seat heating

Repeatedly switching on the seat heating can cause the seat cushion and seat backrest padding to become very hot.

In particular, the health of persons with limited temperature sensitivity or a limited ability to react to high temperatures may be affected or they may even suffer burn-like injuries.

Do not repeatedly switch on the seat heating.

To protect against overheating, the seat heating may be temporarily deactivated after it has been switched on repeatedly.

NOTE Damage to the seats caused by objects or documents when the seat heating is switched on

When the seat heating is switched on, overheating may occur due to objects or docu-

ments placed on the seats, e.g. seat cushions or child seats. This could cause damage to the seat surface.

- ▶ Make sure that no objects or documents are on the seats when the seat heating is switched on.

Requirements

- The power supply is switched on.

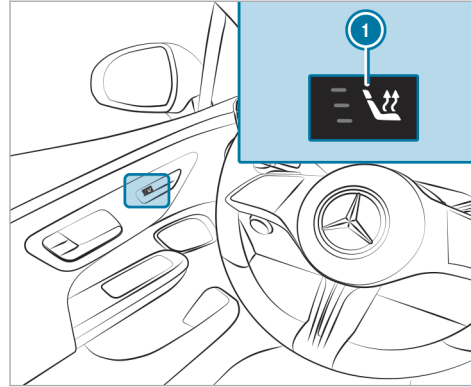

Seat heating in the door operating unit in the cockpit (example)

- ▶ Press button ① for the respective seat repeatedly until the desired heating level is reached. Depending on the heating level, up to three indicator lamps will light up. If all indicator lamps are off, the seat heating is switched off.

- ① The seat heating will automatically switch down from the three heating levels after 8, 10 and 20 minutes until the seat heating switches off.
- ① If you switch the power supply off and on again within 20 minutes, the previous setting of the seat heating for the driver's seat will remain active.

Switching the seat ventilation on/off

Requirements

- The power supply is switched on.

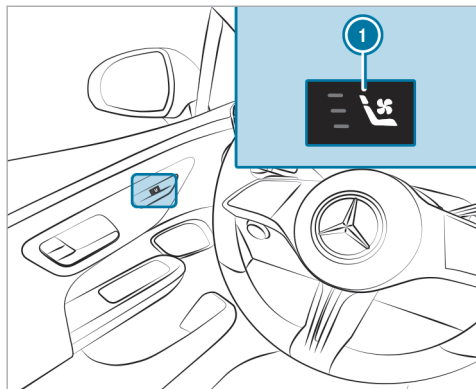

Seat ventilation in the door operating unit in the cockpit (example)

- ▶ Press button ① for the respective seat repeatedly until the desired blower setting is reached. Depending on the blower setting, up to three indicator lamps will light up. If all indicator lamps are off, the seat ventilation is switched off.

- ① If you switch the power supply off and on again within 20 minutes, the previous seat ventilation setting for the driver's seat will remain active.

Steering wheel

Adjusting the steering wheel electrically

- ⚠ **WARNING** Risk of accident due to adjusting the vehicle settings while the vehicle is in motion

You could lose control of the vehicle in the following situations in particular:

- If you adjust the driver's seat, the head restraint, the steering wheel or the mirror while the vehicle is in motion
- If you fasten your seat belt while the vehicle is in motion
- ▶ Before starting the vehicle: in particular, adjust the driver's seat, head restraint, steering wheel and mirror, and fasten your seat belt.

- ⚠ **WARNING** Risk of entrapment for children when adjusting the steering wheel

Children could injure themselves if they adjust the steering wheel.

- ▶ Never leave children unattended in the vehicle.
- ▶ When leaving the vehicle, always take the key with you and lock the vehicle.

This also applies to the Digital Vehicle Key. The steering wheel can be adjusted when the power supply is disconnected.

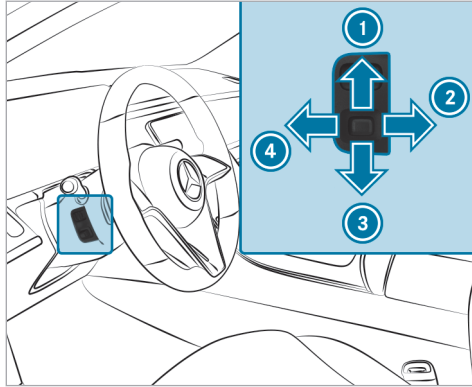

- ① To move up
- ② To move back
- ③ To move down
- ④ To move forward

▶ Save the settings with the memory function (→ page 124).

Decoupling the steering wheel heater from the seat heating

Requirements

- The power supply or the vehicle has been switched on.
- The steering wheel heater and the seat heating are linked.

Multimedia system:

→ ▶▶ Comfort ▶▶ Seat
▶▶ Heating Settings

The function is active by default and the steering wheel heater is automatically activated and deactivated when you switch the seat heating on and off.

- ▶ Tap on **Additional Steering Wheel Heating**.
The steering wheel heater is decoupled from the seat heating.

Easy entry and exit feature

Using the easy entry and exit feature

⚠ WARNING Risk of accident when pulling away during the adjustment process of the easy entry and exit feature

You could lose control of the vehicle.

- ▶ Always wait until the adjustment process is complete before driving off.

⚠ WARNING Risk of becoming trapped when adjusting the easy entry and exit feature

You and other vehicle occupants, particularly children, may become trapped.

- ▶ Make sure that no one has any part of their body within the range of movement of the steering wheel and driver's seat.

If there is a risk of becoming trapped by the steering wheel:

- ▶ Move the steering wheel adjustment lever.
The adjustment process is stopped.

If there is a risk of becoming trapped by the driver's seat:

- ▶ Press the switch for seat adjustment.
The adjustment process is stopped.
- ▶ Never leave children unattended in the vehicle.
- ▶ When leaving the vehicle, always take the key with you and lock the vehicle.

Vehicles with memory function: You can stop the adjustment process by pressing one of the memory function position switches.

⚠ WARNING Risk of becoming trapped if children activate the easy entry and exit feature

Children could become trapped if they activate the easy entry and exit feature, particularly when unattended.

- ▶ Never leave children unattended in the vehicle.
- ▶ When leaving the vehicle, always take the key with you and lock the vehicle.

In order to use the easy entry and exit feature, the automatic seat adjustment function must have been switched on (→ page 117).

When the easy entry and exit feature is active, the steering wheel and driver's seat will move as follows:

- The steering wheel will move upwards.
- The driver's seat will move forward or backward to a seat position suitable for getting out of the vehicle.

This will occur in the following situations:

- You switch off the vehicle when the driver's door is open.
- You open the driver's door when the vehicle is switched off.

- ⓘ The steering wheel will then move upwards only if it is not already as high as it will go.

The driver's seat will then move backwards only if it is not already at the rear of the seat adjustment range.

The steering wheel and the driver's seat will move back to the last driving position in the following cases:

- You switch the power supply or the vehicle on when the driver's door is closed.
- You close the driver's door when the vehicle is switched on.

The last drive position will be saved when:

- You switch off the vehicle.
- **Vehicles with memory function:** you call up the seat settings via the memory function.

Vehicles with memory function: press one of the memory function position switches to stop the adjustment process.

Setting the easy entry and exit feature

Requirements

- The automatic seat adjustment has been activated (→ page 117).

Multimedia system:

→  → Settings → Vehicle
→ Easy Entry And Exit Feature

▶ Select **Steering Wheel & Seat, Steering Wheel Only** or **Off**.

ⓘ If you are using an individual user profile, this information is used for the easy entry and exit feature. This will cause the driver's seat and steering wheel to move into the correct position automatically .

Memory function

Function of the memory function

⚠ WARNING Risk of an accident if the memory function is used while driving

If you use the memory function on the driver's side while driving, you could lose control of the vehicle as a result of the adjustments being made.

▶ Only use the memory function on the driver's side when the vehicle is stationary.

⚠ WARNING Risk of entrapment when adjusting the seat with the memory function

When the memory function adjusts the seat, you and other vehicle occupants – particularly children – could become trapped.

- ▶ During the adjusting process of the memory function, ensure that no body parts are in the area of movement of the seat or the steering wheel.
- ▶ If someone becomes trapped, press a preset position button or seat adjustment switch immediately. The adjustment process is stopped.

⚠ WARNING Danger of entrapment when memory function is activated by children

When children activate the memory function, they can get trapped, especially if they are unsupervised.

- ▶ Never leave children unattended in the vehicle.
- ▶ When leaving the vehicle, always take the key with you and lock the vehicle.

You can use the memory function when the vehicle is switched off.

Seat adjustments for up to three people can be stored and called up using the memory function.

You can save the following settings for the front seat:

- Seat, backrest, head restraint position and contour of the seat backrest in the lumbar region
- Seat heating: distribution of the heated sections of the seat cushion and seat backrest

- Driver's side: steering wheel position and position of the outside mirrors on the driver's and front passenger sides
- Head-up display

Operating the memory function

Storing

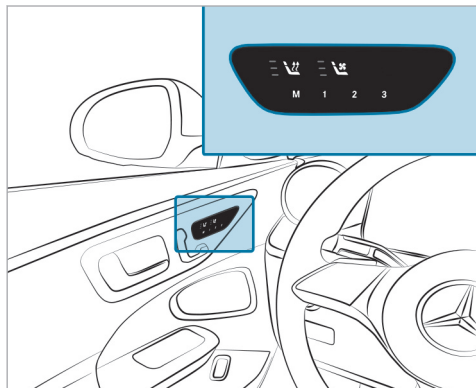

- ▶ Set the seat, the steering wheel, the head-up display and the outside mirror to the desired position.
- ▶ Press the **M** button and then release it.
- ▶ Press one of the preset position buttons **1**, **2** or **3** within three seconds. An acoustic signal sounds. The settings are stored.
- ▶ **To call up:** press the preset position button **1**, **2** or **3**. The seat is moved to the stored position. After releasing the button, the front seat, outside mirror, head-up display and steering column continue to move into the stored position automatically.

Stowage areas

Notes on loading the vehicle

Objects in the deployment area of an air bag may prevent the air bag from functioning correctly. Observe the notes on protection provided by the air bag.

⚠ WARNING Risk of injury from unsecured items in the vehicle

If objects, luggage or loads are not secured or not secured sufficiently, they could slip, tip over or be thrown around and thereby hit vehicle occupants.

There is a risk of injury, particularly in the event of sudden braking or a sudden change in direction.

- ▶ Always stow objects in such a way that they cannot be thrown around.
- ▶ Before the journey, secure objects, luggage or loads against slipping or tipping over.

⚠ WARNING Risk of injury due to objects being stowed incorrectly

If objects in the vehicle interior are stowed incorrectly, they can slide or be thrown around and hit vehicle occupants. In addition, cup holders, open storage spaces and mobile phone receptacles cannot always retain all objects within.

There is a risk of injury, particularly in the event of sudden braking or abrupt changes in direction.

- ▶ Always store objects such that they cannot be thrown around in such situations.
- ▶ Always make sure that objects do not protrude from storage spaces, parcel nets or storage nets.
- ▶ Close the lockable storage spaces before starting a journey.
- ▶ Stow and secure objects that are heavy, hard, pointed, sharp-edged, fragile or too large in the cargo compartment.

⚠ WARNING Risk of accident from objects in the driver's footwell and front-passenger footwell

Objects in the driver's footwell and front-passenger footwell may impede pedal travel or block a depressed pedal.

This jeopardizes the operating and road safety of the vehicle.

- ▶ Stow all objects in the vehicle securely so that they cannot get into the driver's footwell or front-passenger footwell.
- ▶ Always install the floor mats securely and as prescribed in order to ensure that there is always sufficient clearance for the pedals.
- ▶ Do not use loose floor mats and do not lay multiple floor mats on top of one another.

Vehicles with automatic front-passenger air bag shutoff: objects trapped under the front-passenger seat may interfere with the function of the automatic front-passenger air bag shutoff or damage the system. Please observe the notes on the function of the automatic front-passenger air bag shutoff (→ page 51).

⚠ WARNING - Risk of accident or injury when using the cup holder while the vehicle is moving

The cup holder cannot secure containers while the vehicle is moving.

If you use a cup holder while the vehicle is moving, the container may be flung around and liquids may be spilled. The vehicle occupants may come into contact with the liquid and if it is hot, they could be scalded. You could be distracted from traffic conditions and you may lose control of the vehicle.

- ▶ Only use the cup holder when the vehicle is stationary.
- ▶ Only use the cup holder for containers of the right size.
- ▶ Close the container, particularly if the liquid is hot.

! NOTE Damage to the cup holder

The cup holder can be damaged when folding back the rear armrest. When open, the cup holder can be damaged by body weight.

- ▶ The rear armrest can only be folded back when the cup holder is closed.
- ▶ Do not sit or support yourself on the cup holder when it is open.

! **NOTE** Damage to the rear armrest due to body weight

When folded out, the rear armrest can be damaged by body weight.

- ▶ Do not sit or support yourself on the rear seat armrest.

! **WARNING** Risk of injury due to an open cargo compartment floor

If you drive with the cargo compartment floor open, objects could be flung around and hit vehicle occupants as a result. There is a risk of injury, particularly in the event of sudden braking or a sudden change in direction.

- ▶ Always close the cargo compartment floor before a journey.

i Leather is a natural product. It exhibits natural surface properties such as differences in structure, marks caused by growth and injury or subtle color differences. These surface properties are characteristics of leather and not material faults. Leather is also subject to

a natural aging process during which the surface properties change.

The handling characteristics of your vehicle are dependent on the distribution of the load within the vehicle. You should bear the following in mind when loading the vehicle:

- Do not exceed the permissible total mass or the gross axle weight rating of the vehicle (including load and occupants). The values are specified on the vehicle identification plate on the vehicle's B-pillar.
- The load must not protrude above the upper edge of the seat backrests.
- Always place the load behind unoccupied seats if possible.
- Secure the load using the cargo tie-down rings and distribute the load evenly.

Notes on driving with a roof load

- Distribute the roof load and the load inside the vehicle evenly, placing heavy objects at the bottom. Also comply with the notes on loading the vehicle.

- Drive attentively, and avoid abrupt starts, braking and steering as well as rapid cornering.
- When transporting roof loads and when the vehicle is fully loaded or fully occupied, select drive programs **E** and **C**. These are designed to focus on stability (→ page 195).

Stowage spaces in the vehicle interior

■ Overview of the front stowage compartments

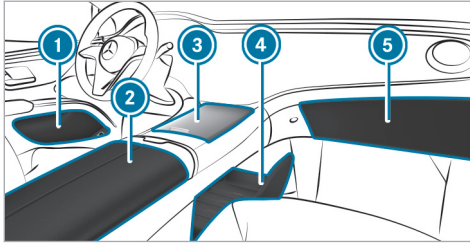

- ① Stowage spaces in the doors
- ② Stowage and telephone compartment beneath the armrest with multimedia and USB ports as well as stowage space, e.g. for an MP3 player
- ③ Stowage compartment in the front center console, depending on vehicle equipment with cupholders, USB ports and charging module for wireless charging of mobile phones
- ④ Stowage tray under the central display of the multimedia system
- ⑤ Glove box

- ⓘ The rubber mat in the stowage compartment in front center console ③ can be removed for cleaning with clean, lukewarm water. Please comply with the notes on caring for the interior (→ page 387).

Opening and closing the stowage compartment in the front center console

⚠ WARNING Risk of injury due to objects being stowed incorrectly

If objects in the vehicle interior are stowed incorrectly, they can slide or be thrown around and hit vehicle occupants. In addition, cup holders, open storage spaces and mobile phone brackets cannot always retain all objects they contain.

There is a risk of injury, particularly in the event of sudden braking or a sudden change in direction.

- ▶ Always stow objects in such a way that they cannot be thrown around in such situations.

- ▶ Always make sure that objects do not protrude from storage spaces, parcel nets or storage nets.
- ▶ Close the lockable storage spaces before starting a journey.
- ▶ Always stow and secure heavy, hard, pointed, sharp-edged, fragile or bulky objects in the trunk.

Observe the notes on loading the vehicle.

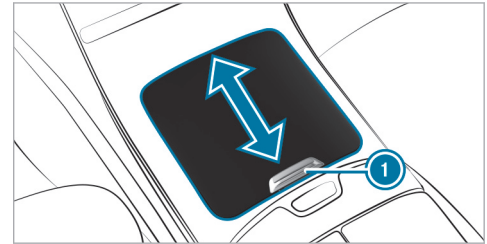

- ▶ **To open:** slide the cover of the stowage compartment in the front center console all the

way forwards in the direction of the arrow using handle ❶.

- ▶ **To close:** briefly push handle ❶ of the open cover of the stowage compartment in the front center console forwards.

The cover will automatically close the stowage compartment in the front center console.

Opening and closing the glove box

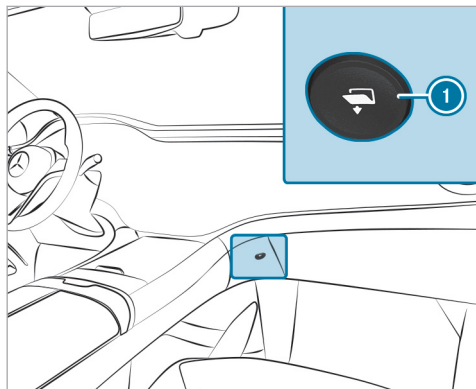

- ▶ **To open:** press button ❶. The glove box will open.

- ▶ **To close:** fold the glove box upwards. The glove box will close.

Through-loading feature in the rear bench seat (EASY-PACK Quickfold)

Folding the rear seat backrests forward

⚠ WARNING Risk of becoming trapped when adjusting the seats

When you adjust a seat, you may trap yourself or a vehicle occupant.

- ▶ When adjusting a seat, make sure that no one has any body parts in the sweep of the seat.

⚠ WARNING Risk of an accident because the seat backrest is not engaged

The seat backrest may fold forwards.

There is a risk of the following, in particular:

- The vehicle occupant may be pressed against the seat belt. The seat belt cannot protect as intended and could cause additional injury.
- A child restraint system is no longer properly supported or properly positioned and may no longer fulfill its function as intended.
- The seat backrest cannot restrain objects or goods in the trunk or cargo compartment.

Always ensure that the seat backrest is engaged, especially:

- After the seat has been adjusted.
- After the cargo compartment enlargement has been folded forwards

Make sure that the red marking of the lock verification indicator is no longer visible. Otherwise, the seat backrest is not locked.

Always ensure that all vehicle occupants have their seat belts fastened correctly and are sitting

properly. Particular attention must be paid to children.

Requirements

- The rear seat backrest head restraints are fully inserted.
- Vehicles with a folding rear passenger compartment armrest: the rear passenger compartment armrest has been folded up.

Folding the rear seat backrests forward mechanically

You can fold the center and right seat backrests forwards separately.

The left seat backrest can be folded forwards only together with the center seat backrest.

If you no longer require the folded-down rear seat backrest as a load area, fold the backrest back into place.

- ▶ Ensure that the center seat backrest is in an upright position and locked to the left seat backrest .

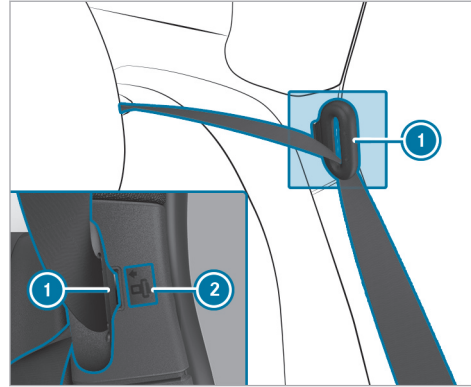

- ▶ Press the seat belt tongue of seat belt ① into marked position ②.
- ▶ Move the driver's or front passenger seat forwards, if necessary.

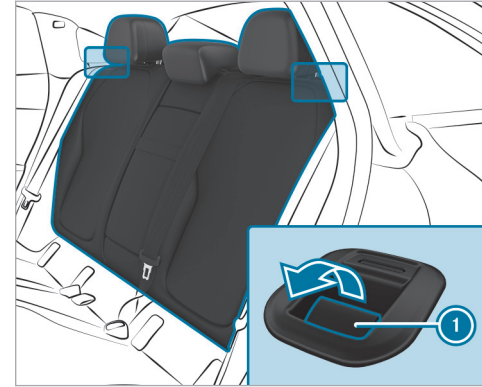

- ▶ Pull release lever ①.
- ▶ Fold the corresponding seat backrest forwards.

Folding the center rear seat backrest forwards separately

If you no longer require the folded-down seat backrest as a load area, fold the backrest back into place.

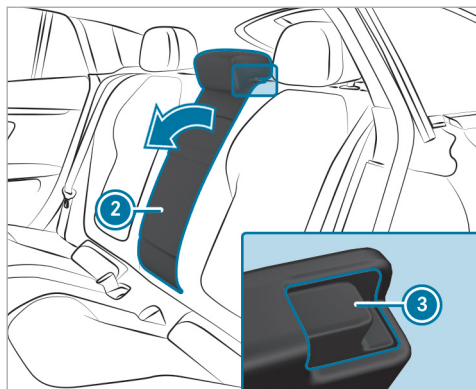

- ▶ Press release catch ③.
- ▶ Fold seat backrest ② forwards.

Folding the rear seat backrest back

! **NOTE** Damage caused by trapping the seat belt when folding back the seat backrest

The seat belt could become trapped and thus damaged when the seat backrest is folded back.

- ▶ Make sure that the seat belt is not trapped when folding back the seat backrest.

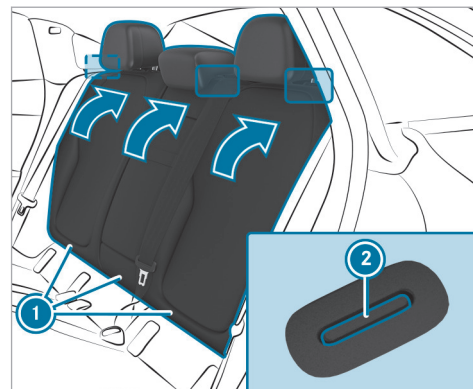

- ▶ Move the driver's or front passenger seat forwards, if necessary.
- ▶ Swivel seat backrest ① back until it engages. Red lock verification indicator ② is no longer visible. The backrest is engaged.
- ① If the seat backrest is not engaged and locked in place, red lock verification indicator ② will be visible.

Adjusting the angle of the rear seat backrests (cargo position)

To enlarge the cargo compartment, you can adjust the seat backrests so that they are 10 degrees steeper (cargo position).

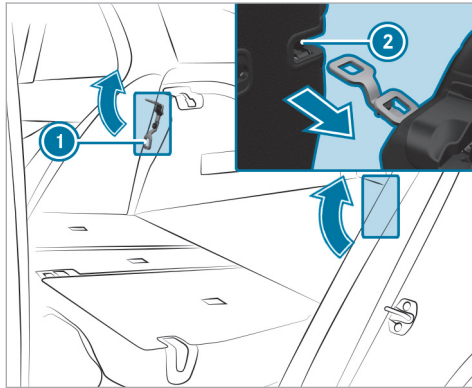

- ▶ Fold the seat backrest forwards (→ page 128).
- ▶ Move bracket ① in the direction of the arrow.

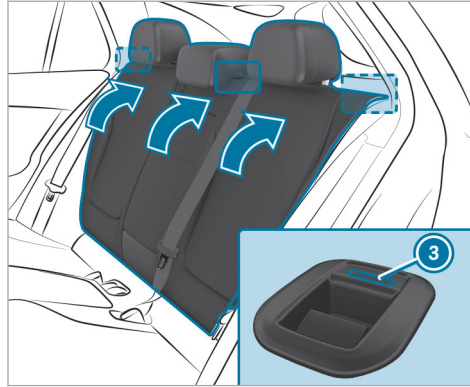

- ▶ Push seat backrest ② back to bracket ① until the backrest engages. If the seat backrest is not engaged and locked in place, red lock verification indicator ③ will be visible.

Cargo compartment cover

Extending/retracting the cargo compartment cover

⚠ WARNING Risk of injury or death due to poorly secured objects

The cargo compartment cover alone cannot secure or restrain heavy objects, items of luggage or heavy loads.

You could be hit by an unsecured load, particularly in the event of abrupt changes in direction, sudden braking or an accident.

- ▶ Always stow objects in such a way that they cannot be thrown around.
- ▶ Secure objects, luggage or loads against slipping or tipping over, e.g. by using tie downs, even if you are using the cargo compartment cover.

! NOTE Damage to the cargo compartment cover when loading the vehicle

The cargo compartment cover may be damaged when the vehicle is being loaded.

- ▶ Do not place any objects above the lower edge of the side windows or on the cargo compartment cover.

The cargo compartment cover is attached behind the seat backrest of the rear bench seat.

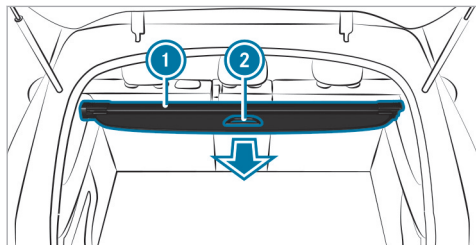

- ▶ **To extend:** pull cargo compartment cover ① back by grab handle ② and hook it into the holders on the left and right.
- ▶ **To retract:** unhook cargo compartment cover ① from the holders on the left and right and guide it forwards by grab handle ② until it is fully retracted.

Installing and removing the cargo compartment cover

Requirements

- The cargo compartment cover is retracted.

Removing the cargo compartment cover

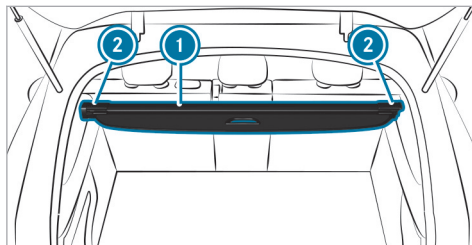

- ▶ Press in the end cap of cargo compartment cover ① on the right- or left-hand side.
- ▶ Push cargo compartment cover ① into recess ② on the opposite side.
- ▶ Take cargo compartment cover ① out by pulling it upwards.

Installing the cargo compartment cover

- ▶ Press in the end cap of cargo compartment cover ① on the opposite side and insert cargo compartment cover ① into other recess ②.
- ▶ Slide the end cap outwards.

Attaching/removing the partitioning net

⚠ WARNING Risk of injury or death due to poorly secured objects

The partitioning net alone cannot secure or restrain heavy objects, items of luggage or heavy loads.

You could be hit by an unsecured load, particularly in the event of abrupt changes in direction, sudden braking or an accident.

- ▶ Always stow objects in such a way that they cannot be thrown around.
- ▶ Secure objects, luggage or loads against slipping or tipping over, e.g. by using tie downs, even if you are using the partitioning net.

For safety reasons, always use a partitioning net when transporting a load.

Damaged partitioning nets can no longer fulfill their functions and must be replaced. Visit a qualified specialist workshop.

Please note that the availability of the partitioning net depends on the equipment.

Attaching

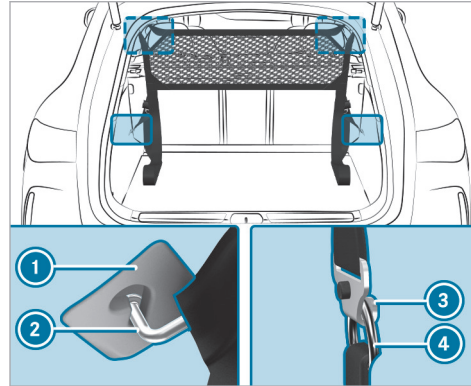

Partitioning net without cargo compartment enlargement

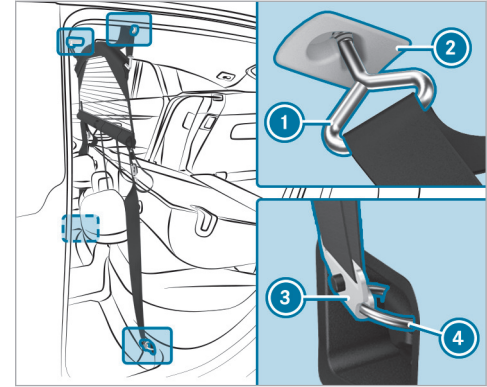

Partitioning net with cargo compartment enlargement

- ▶ Unfold the partitioning net until it audibly clicks into place.
- ▶ Hook partitioning net ① into holders ② on the left and right on the headliner.
- ▶ Engage hooks ③ in tie-down eyes ④ on the left and right.

- ▶ Pull on the loose ends of the lashing straps at the same time until partitioning net ① is tight.

Removing

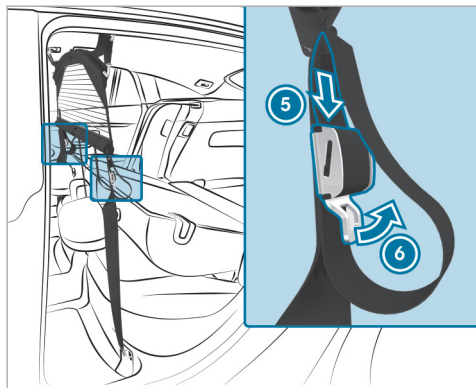

- ▶ Raise the buckle of lashing strap ⑥ in the direction of arrow.

- ▶ Slide the loose end of lashing strap ⑥ into the buckle in the direction of arrow until the lashing straps are loose.
- ▶ Remove hooks ③ from tie-down eyes ④ on the left and right.
- ▶ Remove partitioning net ① from brackets ② on the headliner on the left and right.

Stowing

- ▶ Press the red buttons on the top and bottom guide rods.
- ▶ Collapse and roll up the partition net.

Overview of the tie-down eyes

Observe the notes on loading the vehicle (→ page 124).

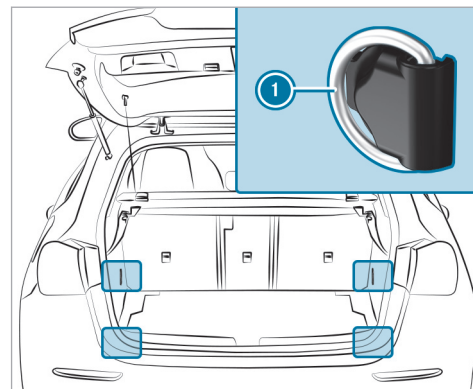

- ① Cargo tie-down rings

Overview of bag hooks

⚠ WARNING Risk of injury when using bag hooks with heavy objects

The bag hooks cannot restrain heavy objects or items of luggage.

Objects or items of luggage may be flung around and hit vehicle occupants.

- ▶ Only hang light objects on the bag hooks.
- ▶ Never hang hard, sharp-edged or fragile objects on the bag hooks.

Observe the notes on loading the vehicle (→ page 124).

Subject the bag hooks to a maximum load of 6.6 lbs (3 kg) and do not attach any goods to them.

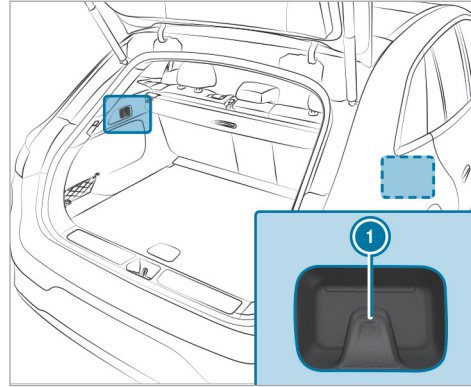

① Bag hooks

Attaching a roof luggage rack

⚠ WARNING Risk of accident due to exceeding the maximum roof load

The vehicle center of gravity and the usual driving characteristics as well as the steering and braking characteristics alter.

If you exceed the maximum roof load, the driving characteristics, as well as steering and braking, will be greatly impaired.

- ▶ Never exceed the maximum roof load and adjust your driving style.

You will find information on the maximum roof load in the "Technical data" section.

! NOTE Damage to the vehicle due to not observing the maximum permitted headroom clearance

If the vehicle height is greater than the maximum permitted headroom clearance, the roof and other parts of the vehicle may be damaged.

- ▶ Observe the signposted headroom clearance.
- ▶ If the vehicle height is greater than the permitted headroom clearance, do not enter.
- ▶ Observe the changed vehicle height with add-on roof equipment.

! **NOTE** Vehicle damage from non-approved roof luggage racks

The vehicle could be damaged by roof luggage racks that have not been tested and approved by Mercedes-Benz.

- ▶ Only use roof luggage racks tested and approved for Mercedes-Benz.
- ▶ Depending on the vehicle equipment, ensure that when the roof luggage rack is installed, the tailgate can be fully opened.
- ▶ Position the load on the roof luggage rack in such a way that the vehicle will

not sustain damage even when it is in motion.

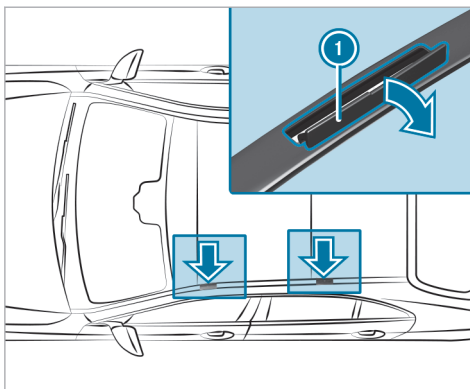

! **NOTE** Damage to the covers

The covers may be damaged and scratched when being opened.

- ▶ Do not use metallic or hard objects.

- ▶ Carefully fold covers ① upwards in the direction of the arrow.
- ▶ Comply with the installation instructions of the roof luggage rack manufacturer.
- ▶ Secure the load on the roof luggage rack.

Cup holder

Installing the cup holder in or removing it from the center console

! **WARNING** - Risk of accident or injury when using the cup holder while the vehicle is moving

The cup holder cannot secure containers while the vehicle is moving.

If you use a cup holder while the vehicle is moving, the container may be flung around and liquids may be spilled. The vehicle occupants may come into contact with the liquid and if it is hot, they could be scalded. You could be distracted from traffic conditions and you may lose control of the vehicle.

- ▶ Only use the cup holder when the vehicle is stationary.
- ▶ Only use the cup holder for containers of the right size.
- ▶ Close the container, particularly if the liquid is hot.

⚠ WARNING Risk of injury due to objects being stowed incorrectly

If objects in the vehicle interior are stowed incorrectly, they can slide or be thrown around and hit vehicle occupants. In addition, cup holders, open storage spaces and mobile phone brackets cannot always retain all objects they contain.

There is a risk of injury, particularly in the event of sudden braking or a sudden change in direction.

- ▶ Always stow objects in such a way that they cannot be thrown around in such situations.

- ▶ Always make sure that objects do not protrude from storage spaces, parcel nets or storage nets.
- ▶ Close the lockable storage spaces before starting a journey.
- ▶ Always stow and secure heavy, hard, pointed, sharp-edged, fragile or bulky objects in the trunk.

Requirements:

- For installation: the locking catch is pushed in the direction of the cup holder.

Observe the notes on loading the vehicle (→ page 124).

Installing

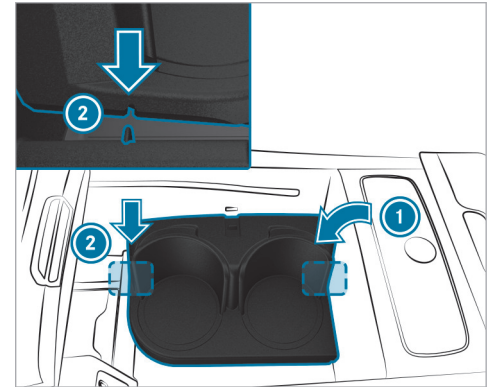

- ▶ Insert cup holder housing ① into the stowage compartment at a slight angle.
- ▶ Place cup holder housing ① in the stowage compartment, aligning the recesses with the two hubs ② so that they fit.
- ▶ Push the cup holder down.

Locking

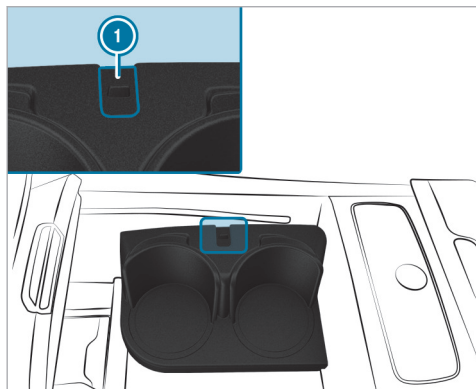

- ▶ Slide locking catch ① toward the side wall of the center console. The cup holder will be locked.

Removing

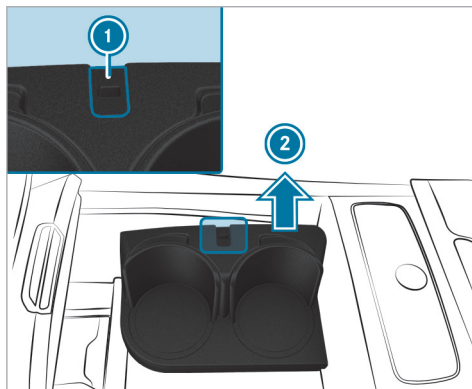

- ▶ Slide locking catch ① toward the cup holder. The cup holder will be unlocked.
- ▶ First pull the cup holder up in the direction of arrow ② and then tilt it slightly to remove it from the stowage compartment.

Using the cup holder

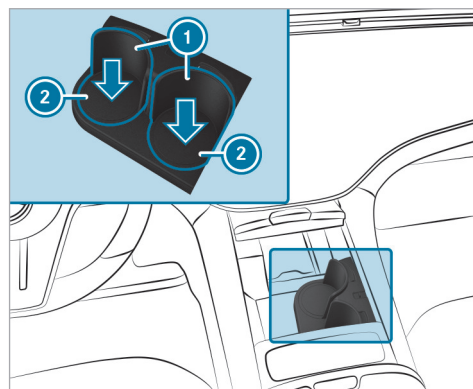

- ▶ Place a beverage container in the cup holder. Bottom ② of the cup holder will lower automatically and side walls ① of the cup holder will move forward automatically.
- ⓘ The cup holder will automatically adjust to the size of the container placed in it.

The side walls of the cup holder can also be activated manually in different ways:

- Press the bottom down slightly with the beverage container.
- Press on the grooved surface on the side wall of the cup holder.

i Check whether the beverage container is held firmly by the cup holder. Some beverage containers will not be secured adequately in the cup holder due to their shape or size.

Original position

When the cup holder is not in use, the side walls of the cup holder can be retracted manually. The bracket arms of the cup holder will automatically be retracted as well, and the cup holder's holding function will then no longer be available.

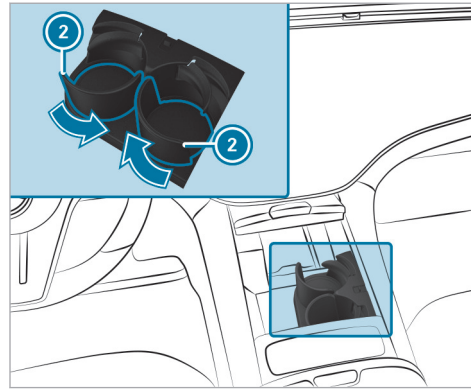

▶ Manually push back the side walls of cup holder **2** in the direction of the arrow.

Opening or closing the cup holder in the rear armrest

⚠ WARNING - Risk of accident or injury when using the cup holder while the vehicle is moving

The cup holder cannot secure containers while the vehicle is moving.

If you use a cup holder while the vehicle is moving, the container may be flung around and liquids may be spilled. The vehicle occupants may come into contact with the liquid and if it is hot, they could be scalded. You could be distracted from traffic conditions and you may lose control of the vehicle.

- ▶ Only use the cup holder when the vehicle is stationary.
- ▶ Only use the cup holder for containers of the right size.
- ▶ Close the container, particularly if the liquid is hot.

! **NOTE** Damage to the rear armrest due to body weight

When folded out, the rear armrest can be damaged by body weight.

- ▶ Do not sit or support yourself on the rear seat armrest.

! **NOTE** Damage to the cup holder

The cup holder can be damaged when folding back the rear armrest. When open, the cup holder can be damaged by body weight.

- ▶ The rear armrest can only be folded back when the cup holder is closed.
- ▶ Do not sit or support yourself on the cup holder when it is open.

Opening the mobile phone holder in the rear armrest

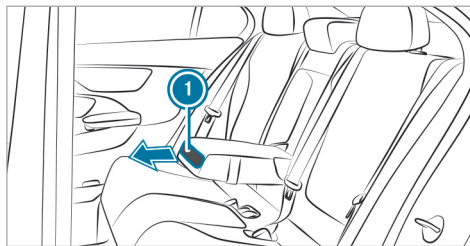

- ▶ Press cover trim **1** once. The mobile phone holder will open in the direction of the arrow.
- ▶ Place the mobile phone in or remove it from the holder.

- i** Observe the notes on loading the vehicle (→ page 124).
- i** The mobile phone holder is designed for two mobile phones or one tablet. You can also charge the devices in the holder by inserting the charging cable into the devices through the opening on the underside of the holder. Observe the notes on USB ports (→ page 141).

Closing the mobile phone holder in the rear armrest

- ▶ Press cover trim **1**. The mobile phone holder and the cup holder will both open.
- ▶ Press cover trim **1** a second time. The mobile phone holder will be closed.

Opening or closing the cup holder in the rear armrest

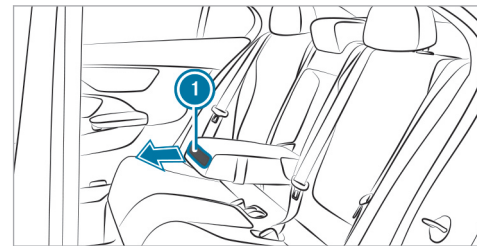

- ▶ **To open:** press cover trim **1** twice. The cup holder will open in the direction of the arrow.

- ▶ Place a container in or remove a container from the cup holder.
- ▶ **To close:** slide the cup holder back into the rear armrest.

Sockets

Using the 12 V socket

Requirements

- Only connect devices up to a maximum of 180 W (15 A).

Depending on the vehicle equipment, the vehicle has 12 V sockets in the front passenger footwell and in the cargo compartment.

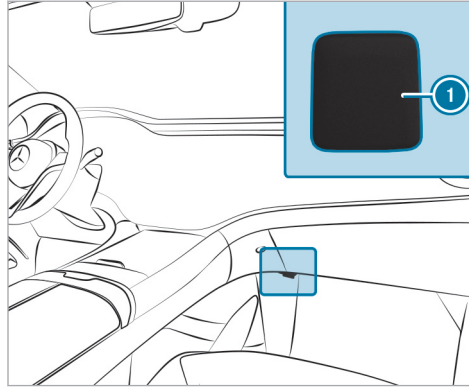

Example: 12 V socket in the front passenger footwell

- ▶ Fold up socket cap ①.
- ▶ Insert the plug of the device.
- ▶ Make sure that no cables are running through or secured in the deployment area of an air bag when using the socket. Also observe the notes on the protection provided by air bags .

USB ports

Depending on its equipment, the vehicle has the following USB ports:

- In the stowage compartment in the front center console
- In the stowage compartment under the front armrest
- In the electronics compartment in the center console of the rear passenger compartment

You can charge a USB device, such as a mobile phone, at the USB ports using a suitable charging cable. Depending on the vehicle equipment, the devices can be charged with up to 20 V (5 A) when the vehicle is switched on.

Wireless charging of the mobile phone and connection with the exterior antenna

Notes on wirelessly charging a mobile phone

⚠ WARNING Risk of injury due to objects being stowed incorrectly

If objects in the vehicle interior are stowed incorrectly, they can slide or be thrown around and hit vehicle occupants. In addition, cup holders, open stowage spaces and mobile phone receptacles cannot always retain all objects within.

There is a risk of injury, particularly in the event of sudden braking or a sudden change in direction.

- ▶ Always stow objects so that they cannot be thrown around in such situations.
- ▶ Always make sure that objects do not protrude from stowage spaces, parcel nets or stowage nets.
- ▶ Close the lockable stowage spaces before starting a journey.

- ▶ Always stow and secure heavy, hard, pointed, sharp-edged, fragile or bulky objects in the trunk/cargo compartment.

Observe the notes on loading the vehicle.

⚠ WARNING Risk of fire from placing objects in the mobile phone storage compartment

Placing other objects in the mobile phone storage compartment could constitute a fire hazard.

- ▶ Apart from a mobile phone, do not place any other objects in the mobile phone storage compartment, especially those made of metal.

! NOTE Damage to objects caused by placing them in the mobile phone storage compartment

If objects are placed in the mobile phone storage compartment, these may be damaged by electromagnetic fields.

- ▶ Do not place credit cards, storage media, ski passes or other objects sensitive to electromagnetic fields in the mobile phone storage compartment.

! NOTE Damage to the mobile phone stowage compartment caused by liquids

If liquids enter the mobile phone stowage compartment, the compartment may be damaged.

- ▶ Ensure that no liquids enter the mobile phone stowage compartment.

Always observe the notes for persons with electronic medical aids (→ page 36).

- Depending on the vehicle equipment, the mobile phone is connected to the vehicle's exterior antenna via the charging module.
- The charging function and wireless connection of the mobile phone to the vehicle's exterior antenna are available only if the vehicle is switched on.

- Small mobile phones may not be able to be charged in every position of the mobile phone stowage compartment.
- Large mobile phones that do not rest flat in the mobile phone stowage compartment may not be able to be charged or connected with the vehicle's exterior antenna.
- The mobile phone may heat up during the charging process. This may also depend on the applications (apps) currently open in the background.
- To ensure more efficient charging and connection with the vehicle's exterior antenna, remove the protective cover from the mobile phone. Protective covers that are necessary for wireless charging are an exception.

Wirelessly charging a mobile phone in the front

Requirements

- The mobile phone is suitable for wireless charging.

A list of compatible mobile phones can be found at: <https://www.mercedes-benz-mobile.com/>

Depending on the vehicle's equipment, the vehicle has the following options for wirelessly charging a mobile phone in the cockpit:

- In the front stowage compartment of the center console
- In the stowage compartment in the armrest

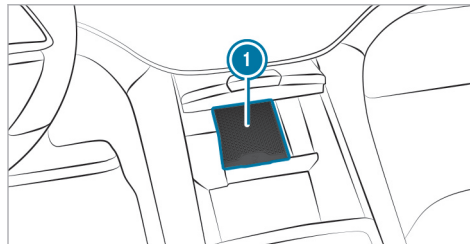

Example: wirelessly charging a mobile phone in the front stowage compartment

- ▶ Place the mobile phone as close to the center of mat ① as possible with the display facing upwards.

When the charging symbol is shown in the multi-media system, the mobile phone is being charged. In addition, malfunctions during the mobile phone's charging process are shown on the multi-media system display.

- ① The mat can be removed for cleaning, e.g. using clean, lukewarm water.

Installing and removing floor mats

⚠ WARNING Risk of accident due to objects in the driver's footwell

Objects in the driver's footwell may impede pedal travel or block a depressed pedal.

This jeopardizes the operating and road safety of the vehicle.

- ▶ Stow all objects in the vehicle securely so that they cannot get into the driver's footwell.

- ▶ Always install the floor mats securely and as prescribed in order to ensure that there is always sufficient room for the pedals.
- ▶ Do not use loose floor mats and do not place floor mats on top of one another.

Installing floor mats

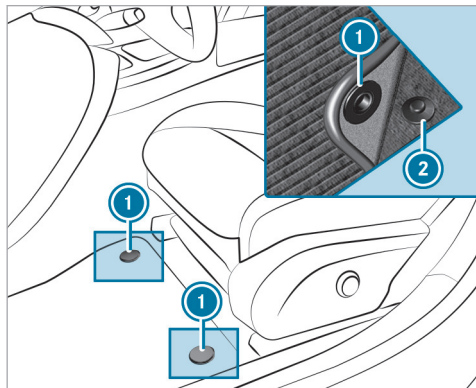

- ▶ Slide the corresponding seat backwards and lay the floor mat in the footwell such that it fits.
- ▶ Press studs ① onto holders ②.
- ▶ Adjust the corresponding seat.

Removing floor mats

- ▶ Slide the corresponding seat backwards and pull the floor mat off holders ②.
- ▶ Adjust the corresponding seat.

Exterior lighting

Information about lighting systems and your responsibility

The various lighting systems of the vehicle are only aids. The driver of the vehicle is responsible for correct vehicle illumination in accordance with the prevailing light and visibility conditions, legal requirements and traffic situation.

Light switch

Operating the light switch

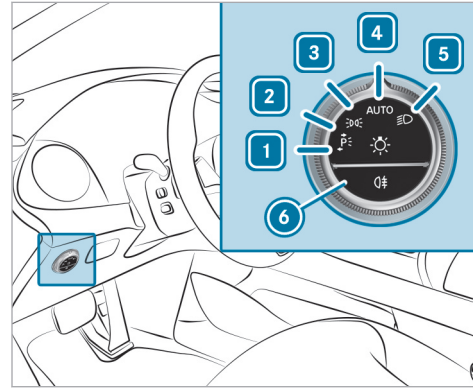

- 1 Left-hand parking lights
- 2 Right-hand parking lights
- 3 Standing lights and license plate lamp
- 4 Automatic driving lights (preferred light switch position)

- 5 Low beam/high beam
- 6 Switches the rear fog light on/off.

When low beam is activated, the indicator lamp for the standing lights will be deactivated and replaced by the low-beam indicator lamp.

▶ Always park your vehicle safely using sufficient lighting, in accordance with the relevant legal stipulations.

! **NOTE** Battery discharging by operating the parking lamps

Do not have the parking lamps switched on over a period of several hours.

If the battery is insufficiently charged, the standing lights or parking lights will be switched off automatically to facilitate the next engine start.

The exterior lighting (except standing and parking lights) will switch off automatically when the driver's door is opened.

- Observe the notes on locator lighting (→ page 154).

Automatic driving lights function

When the vehicle is switched on, the side lamps, low beam and daytime running lights will be switched on automatically depending on the ambient light.

⚠ WARNING Risk of accident when the low beam is switched off in poor visibility



When the light switch is set to **AUTO**, the low beam may not be switched on automatically if there is fog, snow or other causes of poor visibility such as spray.

▶ In such cases, turn the light switch to .

The automatic driving lights are only an aid. You are responsible for the vehicle lighting.

Switching the rear fog light on/off

Requirements

- The light switch is in the  or **AUTO** position.
- ▶ Press button .

Please observe the country-specific laws on the use of rear fog lamps.

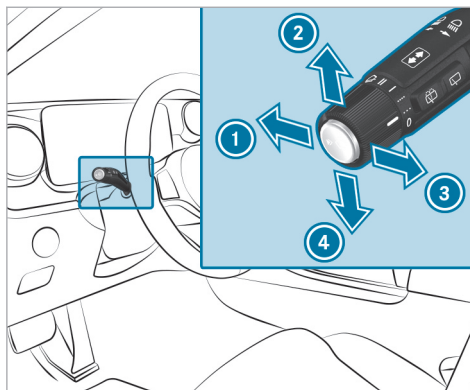

Operating the combination switch for the lights



- 1 High beam
- 2 Turn signal light, right
- 3 Headlamp flashing
- 4 Turn signal light, left

- ▶ Use the combination switch to select the desired function.

Switching on high beam

- ▶ Turn the light switch to the  or **AUTO** position.
- ▶ Push the combination switch in the direction of arrow 1. When high beam is activated, the indicator lamp for low beam  will be deactivated and replaced by the indicator lamp for high beam .

Switching off high beam

- ▶ Push the combination switch in the direction of arrow 1 or pull it in the direction of arrow 3.

Headlamp flashing

- ▶ Pull the combination switch in the direction of arrow 3.

Turn signals

- ▶ **To indicate briefly:** push the combination switch briefly to the point of resistance in the direction of arrow ② or ④. The corresponding turn signal light will flash three times.
- ▶ **To indicate permanently:** push the combination switch beyond the point of resistance in the direction of arrow ② or ④.

Vehicles with Active Lane Change Assist:

- A turn signal indicator activated by the driver may continue to operate for the duration of the lane change.
- If the driver indicated directly beforehand but a lane change was not immediately possible, the turn signal indicator may activate automatically.

Activating/deactivating the hazard warning lights

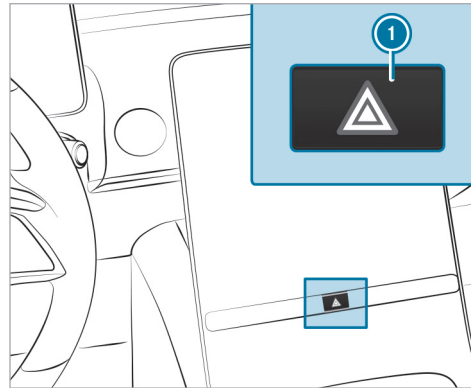

Vehicles without MBUX Hyperscreen

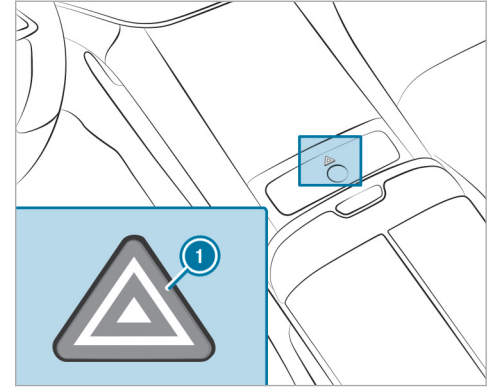

Vehicles with MBUX Hyperscreen

- ▶ Press button ①.

The hazard warning lights will switch on automatically if:

- the air bag has been deployed.

DIGITAL LIGHT adaptive functions

Intelligent Light System function

With this system, the headlamps adapt to the driving and weather situation. It also provides extended functions for improved illumination of the road.

i The availability of the functions is dependent on the country.

The system comprises the following functions:

- Active headlamps (→ page 148)
- Topographical compensation (→ page 148)

The system is active only when it is dark.

Active headlamps function

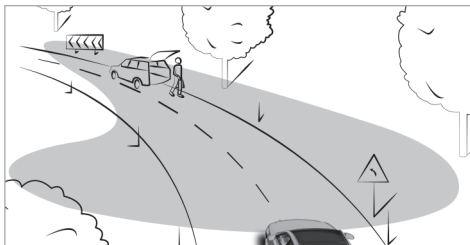

- The headlamps follow the steering movements.
- Relevant areas are better illuminated during a journey.

The functions will be active when low beam is switched on.

Function of the topographical compensation

Based on available map data, the lighting system responds pre-emptively to different road heights. This means that the headlamp range remains virtually constant when you are driving on uphill or downhill gradients.

i Only vehicles with a multimedia system with navigation have this function.

Assistance functions of DIGITAL LIGHT

DIGITAL LIGHT visually expands on the driver assistance systems by projecting the assistant displays in front of the vehicle while it is in motion. DIGITAL LIGHT can therefore help the driver in critical situations.

i The availability of the functions is dependent on the country.

i The assistance functions of DIGITAL LIGHT may be an on-demand feature (→ page 29).

The system will be active in the following cases:

- The light switch is in the **AUTO** position.
- High beam is switched on.
- i** Depending on the country in which you are currently driving, certain functions may be disabled due to different legal requirements, even if they are enabled in the multimedia system. When you cross a border, the vehicle will automatically adapt to the applicable requirements.

Spotlight

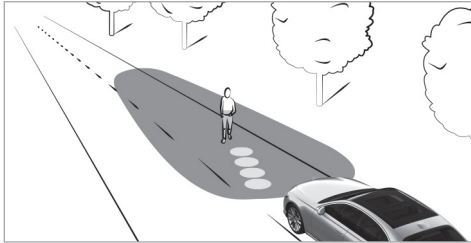

The spotlight function runs in the background and flashes the headlamps in four short bursts at persons detected within the lane markings. You will also be made aware of the position of the person by a projected symbol.

The function will be active in the following circumstances:

- You are driving outside illuminated areas.
- The system detects a lane marking.

Notes

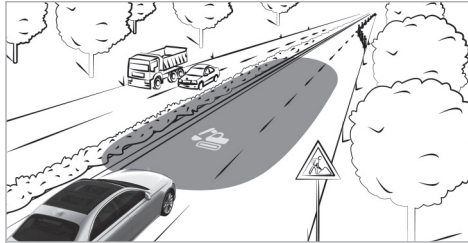

If Traffic Sign Assist detects a roadworks zone, the system will provide support as follows:

- A corresponding symbol will be projected onto the road when you enter a roadworks zone.

Observe the system limitations of Traffic Sign Assist (→ page 259).

Collision warning

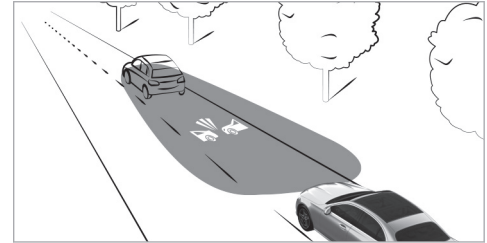

If you fall below the safe distance at speeds of at least 19 mph (30 km/h), a collision warning symbol will be projected onto the road.

Observe the system limitations of Active Brake Assist (→ page 254).

Lane change warning

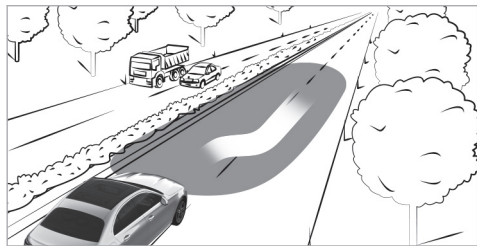

During assisted lane changes at speeds of at least 19 mph (30 km/h), the course of the lane change will flash.

Observe the system limitations of Active Lane Change Assist (→ page 250).

Lane keeping and blind spot warning

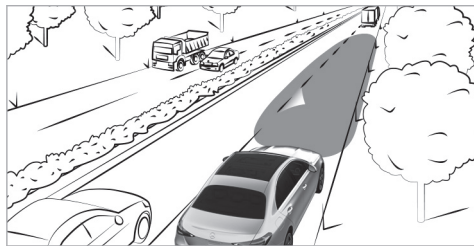

At speeds of at least 19 mph (30 km/h), a triangle that indicates a lane correction and its direction will be projected onto the road in the following cases:

- You leave the lane unintentionally.
Observe the system limitations of Active Lane Keeping Assist (→ page 267).
- You switch on the turn signal light while an object or obstacle is in your blind spot.
Observe the system limitations of Active Blind Spot Assist (→ page 264).

Switching the Intelligent Light System on/off

Requirements

- The vehicle is switched on.

Multimedia system:

→  **Settings** **Light**
▶ **DIGITAL LIGHT**

- ▶ Activate or deactivate **Dynamic Low Beam**.

Activating or deactivating enhanced assistance functions

- ① The availability of the functions is dependent on the country.
- ① This function is an on-demand feature (→ page 29).
- ▶ Select **Supporting Projections**.
- ▶ Activate or deactivate the desired projections.
- ▶ Switch **Projection for greeting/farewell** on or off.
If the locator lighting or the exterior switch-off delay time is activated, a high-resolution greeting or farewell scene will be played back for a short period of time when the vehicle is

opened or switched off. You can choose between the **Digital Rain** and **Particle Flow** sequences.

- i More information on locator lighting (→ page 154)
 More information on the exterior switch-off delay time (→ page 154)

Adaptive Highbeam Assist

Adaptive Highbeam Assist function

⚠ WARNING Risk of accident despite Adaptive Highbeam Assist

Adaptive Highbeam Assist does not react to:

- Road users without lights, e.g. pedestrians
- Road users with poor lighting, e.g. cyclists
- Road users whose lighting is obstructed, e.g. by a barrier

On very rare occasions, Adaptive Highbeam Assist may fail to recognize other road users with their own lighting, or may recognize them too late.

In these, or in similar situations, the automatic high beam will not be deactivated or will be activated despite the presence of other road users.

- ▶ Always observe the road and traffic conditions carefully and switch off the high beam in good time.

Adaptive Highbeam Assist cannot take into account road, weather or traffic conditions. Detection may be restricted in the following cases:

- In poor visibility, e.g. fog, heavy rain or snow
- if there is dirt on the sensors or the sensors are obscured

Adaptive Highbeam Assist is only an aid. You are responsible for adjusting the vehicle's lighting to the prevailing light, visibility and traffic conditions.

- i Adaptive Highbeam Assist is available on demand (→ page 29).

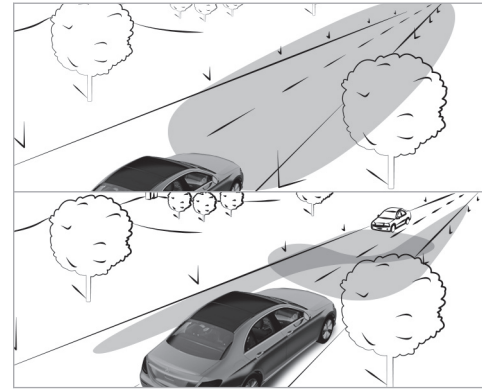

Adaptive Highbeam Assist automatically switches between the following types of light:

- Low-beam headlamps
- High beam

At speeds greater than 19 mph (30 km/h):

- If no other road users are detected, high beam will switch on automatically.

The high beam will switch off automatically in the following cases:

- At speeds below 16 mph (25 km/h)
 - If other road users are detected
 - If street lighting is sufficient
- ❗ The system's optical sensor is located behind the windshield near the overhead control panel.

Switching Adaptive Highbeam Assist on/off

Switching on

- ▶ Turn the light switch to the **AUTO** position.
- ▶ Switch on high beam using the combination switch.
If Adaptive Highbeam Assist is activated, the  indicator lamp will light up on the driver's display.

Switching off

- ▶ Switch off high beam using the combination switch.

Adaptive Highbeam Assist Plus

Adaptive Highbeam Assist Plus function (Canada)

⚠ WARNING Risk of accident despite Adaptive Highbeam Assist Plus

Adaptive Highbeam Assist Plus does not react to:

- Road users without lights, e.g. pedestrians
- Road users with poor lighting, e.g. cyclists
- Road users whose lighting is obstructed, e.g. by a barrier

On very rare occasions, Adaptive Highbeam Assist Plus may fail to recognize other road users with their own lighting, or may recognize them too late.

In these, or in similar situations, the automatic high beam will not be deactivated or will be activated despite the presence of other road users.

- ▶ Always observe the road and traffic conditions carefully and switch off the high beam in good time.

Adaptive Highbeam Assist Plus cannot take into account road, weather or traffic conditions.

Detection may be restricted in the following cases:

- In poor visibility, e.g. fog, heavy rain or snow
- if there is dirt on the sensors or the sensors are obscured

Adaptive Highbeam Assist Plus is only an aid. You are responsible for adjusting the vehicle's lighting to the prevailing light, visibility and traffic conditions.

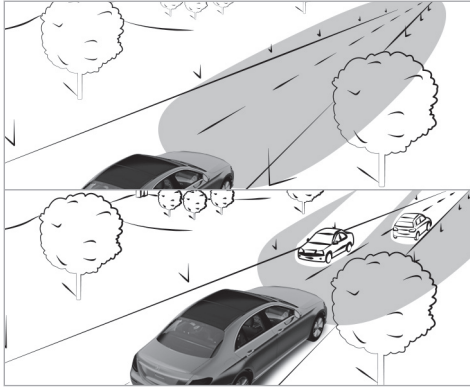

Adaptive Highbeam Assist Plus automatically switches between the following types of light:

- Low-beam headlamps
- Partial high beam
- High beam
- ULTRA RANGE Highbeam

ULTRA RANGE Highbeam increases the brightness of the cone of light to the legally permitted maximum.

Partial high beam does not include other road users in the high beam area. It does not dazzle them but enables full high-beam illumination for the driver apart from the excluded vehicles. Highly reflective signs are also illuminated with reduced brightness.

At speeds below 16 mph (25 km/h) or when there is sufficient street lighting:

- Partial high beam and high beam will be switched off automatically.

At speeds greater than 19 mph (30 km/h):

- If no other road users are detected, high beam will switch on automatically.
- If other road users are detected, partial high beam will switch on automatically.

at speeds below 25 mph (40 km/h):

- The ULTRA RANGE Highbeam will switch off automatically.

At speeds above 31 mph (50 km/h):

- If no other road users are detected, the road is straight and it is not raining heavily, the ULTRA RANGE Highbeam will be switched on automatically.
- If other road users are detected, partial high beam will switch on automatically.
- If highly reflective signs are detected, ULTRA RANGE Highbeam will be switched off automatically.

i The system's optical sensor is located behind the windshield near the overhead control panel.

Switching Adaptive Highbeam Assist Plus on/off (Canada)

Switching on

▶ Turn the light switch to the **AUTO** position.

▶ Switch on high beam using the combination switch.

If Adaptive Highbeam Assist Plus is activated, the  indicator lamp will light up on the driver's display. When partial high beam or

high beam is active, the corresponding blue indicator lamp will also light up.

Switching off

- ▶ Switch off high beam using the combination switch.

Switching the daytime running lamps on/off

Multimedia system:

→  ▶ Settings ▶ Light
▶▶ DIGITAL LIGHT

- ▶ Activate or deactivate the **Daytime Running Lights**.
- ⓘ In vehicles without DIGITAL LIGHT headlamps, the daytime running lamps can be switched on or off in the **driving lights** menu.
- ⓘ The availability of the function is dependent on the country.

Setting the exterior lighting switch-off delay time

Multimedia system:

→  ▶ Settings ▶ Light
▶▶ Interior/Exterior Lighting
▶▶ External Lighting Delay

- ▶ Set the switch-off delay time. When the vehicle's engine is switched off, the exterior lighting will be activated for the set time.

Activating/deactivating the locator lighting

Multimedia system:

→  ▶ Settings ▶ Light
▶▶ Interior/Exterior Lighting



- ▶ Activate or deactivate **Locator Lighting**.

When the function is activated, the exterior lighting will light up for 40 seconds after the vehicle is unlocked or the driver's door is opened when the vehicle is parked and not locked. When you start the vehicle, the locator lighting will be deactivated and the automatic driving lights activated.

Interior lighting

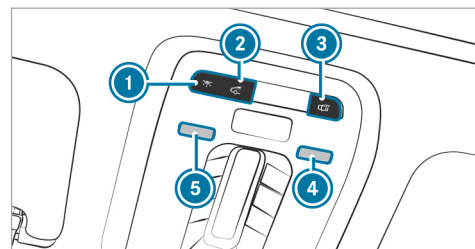
Adjusting the interior lighting



- ①  Switches the front interior lighting on/off.
- ②  Switches the rear interior lighting on/off.
- ③  Switches automatic interior lighting control on/off.

- ▶ **To switch reading lamps on/off:** touch respective reading lamp ④ or ⑤.

Operating unit in the rear passenger compartment

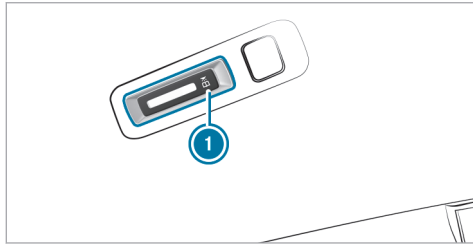

①  Rear passenger compartment reading lamp

▶ **To switch on or off:** press button ①.

Adjusting the ambient lighting

Multimedia system:

 ▶▶ Comfort ▶▶ Ambient Light

Setting the color

- ▶ Select **Color**.
- ▶ Select **Monochrome** or **Multi-color**.

▶ Set the desired color or color scheme.

Energy Shine

- The interactive Energy Shine color scheme shows the different phases during the journey. Depending on the type of driving condition (speed, boost effect or recuperation), this is shown in color by the active ambient lighting.

Adjusting the brightness

- ▶ Select **Brightness**.
- ▶ Adjust the brightness.
- ① Depending on the ambient light, the ambient lighting will automatically switch between day and night modes.

Activating the brightness for zones

- ▶ Select **Brightness**.
- ▶ Switch off **Link Zones**.
The **Direct**, **Indirect** and **Accents** zones can be set separately.
- ① The **Light Band** zone can also be set in vehicles with active ambient lighting.

Activating effects

⚠ WARNING Risk of accident if ambient lighting and active ambient lighting effects are not switched on

The warning assistance effects will be fully active only when the relevant driving or driving safety systems are activated on the Driving Assistance menu.

- ▶ Make sure that the relevant driving or driving safety systems are activated.

- ① Observe the notes on driving systems and your responsibility; you may otherwise fail to recognize dangers (→ page 224).
- ▶ Select **Effects**.
- ▶ Activate the desired effect.
- ① Depending on the vehicle equipment, different effects are available.

Operating feedback effects

- **Climate:** If changes are made to the temperature setting in the vehicle, the color of the ambient lighting will change briefly.

- **Voice Assistant:** In vehicles with active ambient lighting, the voice assistant will be visually animated.
- **Greeting:** When you get into the vehicle, a special color animation will play.
- **Charging sequence:** The ambient lighting provides visual feedback on the different states of charge when the vehicle is connected to or disconnected from the charging station.

Warning assistance effects

- **Warning When Exiting:** If an object is detected in the blind spot while you are getting out of the vehicle, the ambient lighting on the affected door will flash red.
Further information on the exit warning (→ page 264).
- **Active Lane Keeping Assist:** If there is a warning from Active Lane Keeping Assist, the active ambient lighting will flash red.
Further information on Active Lane Keeping Assist (→ page 267).

- **Active Brake Assist:** If there is an Active Brake Assist warning, the active ambient lighting in the center of the cockpit will flash bright red.
Further information on the Active Brake Assist (→ page 254).
- **Active Blind Spot Assist:** In vehicles with active ambient lighting, the ambient lighting on the affected side will flash red if there is a warning from Active Blind Spot Assist.
Further information on Active Blind Spot Assist (→ page 264).
- **Parking Assist PARKTRONIC:** The information from the parking sensors during parking maneuvers is displayed in color.
Further information on Parking Assist PARKTRONIC: (→ page 280)



Multi-color Animation

- The chosen color combination will change at predefined intervals.
- i** In vehicles with active ambient lighting, an animation will be played.

- i** The desired operating feedback and warning assistance can be activated or deactivated via the  symbol. Depending on the equipment, different operating feedback and warning assistance effects are available.
- i** If the brightness is set to a low level, warning animations will be displayed at a higher basic brightness.

Switching the interior lighting switch-off delay time on/off

Multimedia system:

  **» Settings » Light**
» Interior/Exterior Lighting
» Interior Lighting Delay



- ▶** Activate or deactivate **Interior Lighting Delay**. If this function is active, the interior lighting will be switched on for a short time after the end of the journey.

Windshield wiper and windshield washer system

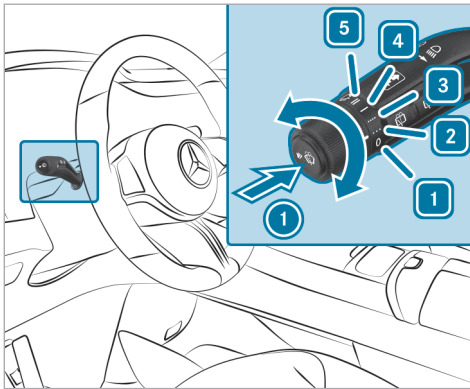
Switching the windshield wipers on/off





- 1 0 Windshield wipers off
- 2 ... Automatic wiping, normal
- 3 Automatic wiping, frequent
- 4 — Continuous wiping, slow
- 5 = Continuous wiping, fast

- ▶ Turn the combination switch to the corresponding position 1 - 5.
- ▶ **Single wipe/washing:** push the button on the combination switch in the direction of arrow 1.
 -  Single wipe
 -  Wipes with washer fluid
- ⓘ Observe the notes on washing the vehicle in a car wash (→ page 381).

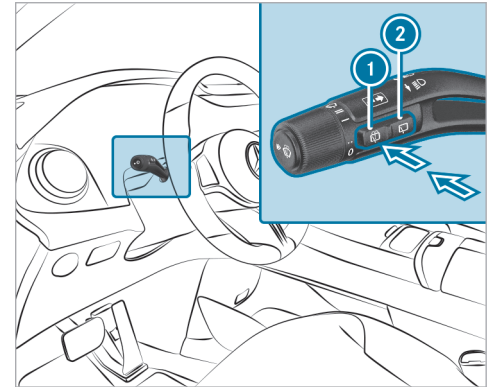
Switching the rear window wiper on/off



- 1  Single wipe/washing
- 2  Intermittent wiping
- ▶ **Single wipe:** press button 1 as far as the point of resistance.
- ▶ **Wiping with washer fluid:** press button 1 beyond the point of resistance.

- ▶ **Switching intermittent wiping on/off:** press button ②. The  symbol will appear on the driver's display when the rear window wiper is switched on.

Replacing the windshield wiper blades

⚠ WARNING Risk of becoming trapped if the windshield wipers are switched on while wiper blades are being replaced

If the windshield wipers begin to move while you are changing the wiper blades, you can be trapped by the wiper arm.

- ▶ Always switch off the windshield wipers and vehicle before changing the wiper blades.

Moving the wiper arms into the replacement position

- ▶ Switch the vehicle on and then off again immediately.

- ▶ Within around 15 seconds, press and hold the  button on the combination switch for approximately three seconds (→ page 157). The wiper arms will move into the replacement position.

Removing the wiper blades

- ▶ Fold the wiper arms away from the windshield.

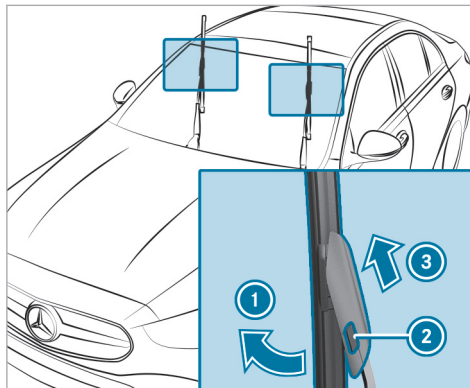

- ▶ Hold the wiper arm with one hand. With the other hand, turn the wiper blade away from the wiper arm in the direction of arrow ① as far as it will go.
- ▶ Press release button ②.
- ▶ Remove the wiper blade from the wiper arm in the direction of arrow ③.

Installing the wiper blades

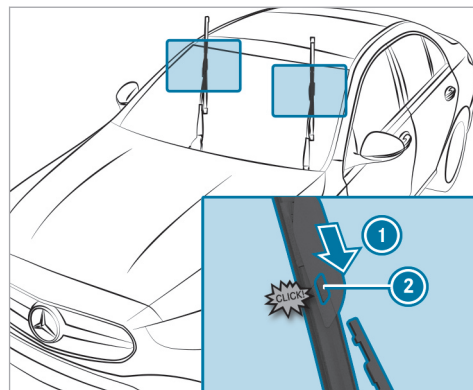

- ▶ Push the new wiper blade into the wiper arm in the direction of arrow ① until release knob ② engages.
 - ▶ Make sure that the wiper blade is seated correctly.
 - ▶ Fold the wiper arms back onto the windshield.
 - ▶ Switch on the vehicle.
 - ▶ Press the  button on the combination switch. The wiper arms will return to their original positions.
 - ▶ Switch off the vehicle.
- ① Check the condition of the wiper blades regularly and replace them in the event of visible damage or ongoing smearing.

Maintenance display

There is a maintenance display at the tip of the newly mounted wiper blade.

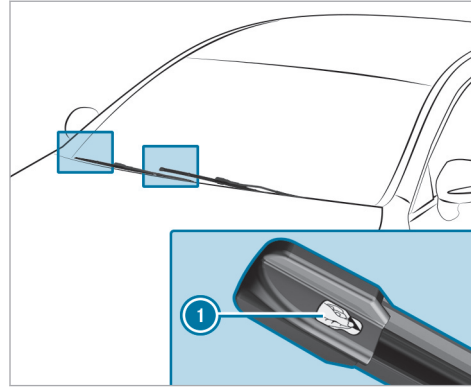

- ▶ Remove protective film ① from the maintenance display.

When the color of the maintenance display changes from black to yellow, the wiper blades should be replaced.

Replacing the rear window wiper blade

⚠ WARNING Risk of becoming trapped if the windshield wipers are switched on while wiper blades are being replaced

If the windshield wipers begin to move while you are changing the wiper blades, you can be trapped by the wiper arm.

- ▶ Always switch off the windshield wipers and vehicle before changing the wiper blades.

Removing the wiper blade

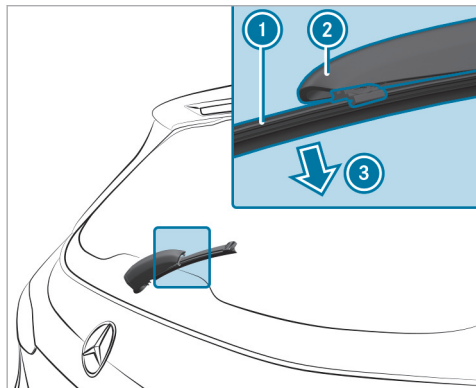

- ▶ Switch off the vehicle.
- ▶ Fold wiper arm ② away from the rear window until it engages in the replacement position.
- ▶ Unclip wiper blade ① from wiper arm ② and remove it in the direction of arrow ③.

Installing the wiper blades

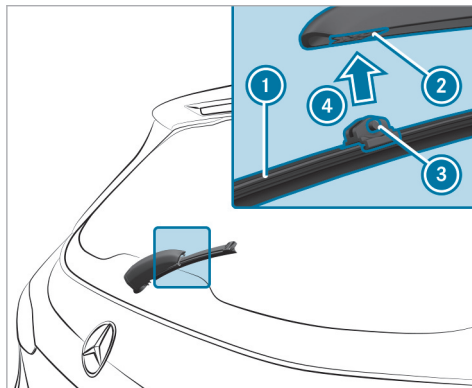

- ▶ Position wiper blade ① with both lugs ③ on holder ② on the wiper arm.
- ▶ Push wiper blade ① in the direction of arrow ④ until it engages in holder ②.
- ▶ Make sure that wiper blade ① is seated correctly.

- ▶ Fold the wiper arm from the replacement position back onto the rear window.

Mirrors

Operating the outside mirrors

⚠ WARNING Risk of accident due to adjusting the vehicle settings while the vehicle is in motion

You could lose control of the vehicle in the following situations in particular:

- If you adjust the driver's seat, the head restraint, the steering wheel or the mirror while the vehicle is in motion
 - If you fasten your seat belt while the vehicle is in motion
- ▶ Before starting the vehicle: in particular, adjust the driver's seat, head restraint, steering wheel and mirror, and fasten your seat belt.

⚠ WARNING Risk of accident due to misjudgment of distance when using the front-passenger mirror

The outside mirror on the front passenger side reflects objects on a smaller scale. The objects in view are in fact closer than they appear.

▶ Therefore, always look over your shoulder to check the actual distance between you and the road users traveling behind you.

Adjusting the outside mirrors

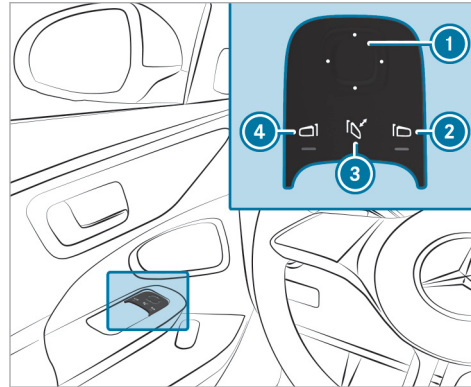

- ▶ Use button ② or ④ to select the desired mirror.
- ▶ Use button ① to adjust the position of the selected mirror.

Folding the outside mirrors in/out (vehicles with electrically folding outside mirrors)

- ▶ Briefly press button ③.

- ① If the battery has been disconnected or has discharged, the outside mirrors must be moved briefly using button ③. Only then will the automatic mirror folding function work properly.

Engaging the outside mirrors

If an outside mirror has been forcibly disengaged, proceed as follows.

- ▶ Vehicles with electrically folding outside mirrors: press and hold button ③. You will hear a click and the mirror will audibly engage. The outside mirror will now be set to the correct position.

Automatic anti-glare mirrors function

⚠ WARNING Risk of acid burns and poisoning due to the anti-glare mirror electrolyte

Electrolyte may escape if the glass in an automatic anti-glare mirror breaks.

The electrolyte is hazardous to health and causes irritation. It must not come into contact

with your skin, eyes, respiratory organs or clothing or be swallowed.

► If you come into contact with electrolyte, observe the following:

- Immediately rinse the electrolyte from your skin with water and seek medical attention.
- If electrolyte comes into contact with your eyes, immediately rinse them thoroughly with clean water and seek medical attention.
- If the electrolyte is swallowed, immediately rinse your mouth out thoroughly. Do not induce vomiting. Seek medical attention immediately.
- Immediately change out of clothing which has been contaminated with electrolyte.
- If an allergic reaction occurs, seek medical attention immediately.

The inside rearview mirror and the outside mirror on the driver's side will automatically go into anti-

glare mode if light from a headlamp hits the sensor on the inside rearview mirror.

System limits

The system will not go into anti-glare mode if:

- The vehicle is switched off.
- Reverse gear is engaged.
- The interior lighting is switched on.

Front-passenger outside mirror parking position function

The parking position makes parking easier.

The front-passenger outside mirror will swivel downwards in the direction of the rear wheel on the front passenger's side when:

- The parking position is stored (→ page 162).
- The front-passenger mirror is selected.
- Reverse gear is engaged.

The front-passenger outside mirror will move back to its original position when:

- You shift the transmission to another transmission position.

- You are traveling at a speed greater than 9 mph (15 km/h).
- You press the button for the outside mirror on the driver's side.

Storing the parking position of the front-passenger outside mirror using reverse gear

Storing

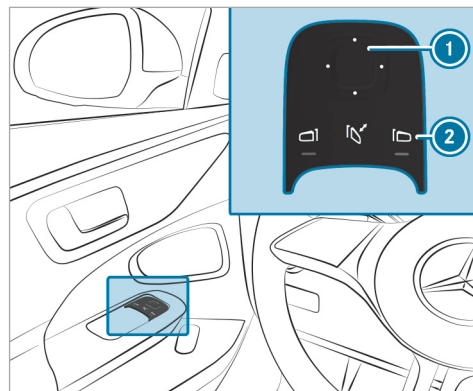

- ▶ Select the front-passenger outside mirror using button ②.
- ▶ Engage reverse gear.
- ▶ Move the front-passenger outside mirror into the desired parking position using button ①.

Calling up

- ▶ Select the front-passenger outside mirror using button ②.
- ▶ Engage reverse gear.
The front-passenger outside mirror will move into the stored parking position.

Activating/deactivating the automatic mirror folding function

Multimedia system:

- ▶  ▶ Settings ▶ Vehicle
- ▶ ▶ Open/Close
- ▶ Activate or deactivate **Automatic Mirror Folding**.

Area permeable to radio waves on the windshield

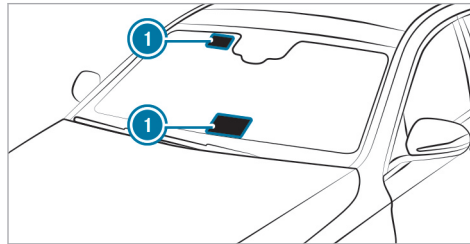

Radio-controlled equipment such as toll systems can be mounted only on areas ① of the windshield that are permeable to radio waves.

Areas permeable to radio waves ① are best visible from outside the vehicle when the windshield is illuminated with an external light source.

Note this position for vehicles with:

- Windshield heater
- Infra-red reflective windshield

Infrared-reflective windshield function

The infrared-reflective windshield is coated and reduces the build-up of heat in the vehicle interior. The coating shields the vehicle interior from radio waves.

Overview of climate control systems

Notes on climate control

An interior air filter in combination with the prefilter in the engine compartment must always be used so that the air conditioning system, pollution level monitoring and the air filtration work correctly. Use filters recommended and approved by Mercedes-Benz. Always have maintenance work carried out at a qualified specialist workshop.

Overview of the THERMATIC climate bar

The indicator lamps indicate that the corresponding functions are activated.

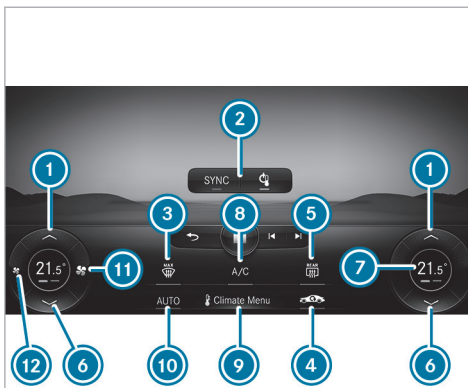

Front climate bar on the central display (example)

- ① Increases the temperature
- ② Upper display area of the climate bar with the examples of switching climate control on/off (→ page 167) and **SYNC** synchronisation function (→ page 170)
- ③ Defrosts the windshield (→ page 168)

- ④ Switches the A/C function on/off (→ page 168) or Fine particle prefilter status display (→ page 167)
- ⑤ Switches the rear window defroster on/off
- ⑥ Reduces the temperature
- ⑦ Depending on vehicle equipment and settings: temperature display, display for the defrost function, airflow, pre-entry climate control or climate mode
- ⑧ Switches air-recirculation mode on/off (→ page 170, 171)
- ⑨ Calls up the air conditioning menu (→ page 167)
- ⑩ **AUTO** Sets climate control to automatic mode (→ page 168)
- ⑪ Increases the airflow or switches on climate control (→ page 167)
- ⑫ Reduces the airflow or switches off climate control (→ page 167)

- ❶ The climate bar will remain visible even when the vehicle is parked or the air conditioning is switched off (→ page 167).
- ❷ The availability of individual functions depends on the country and equipment.

Overview of the THERMOTRONIC climate bar

The indicator lamps indicate that the corresponding functions are activated.

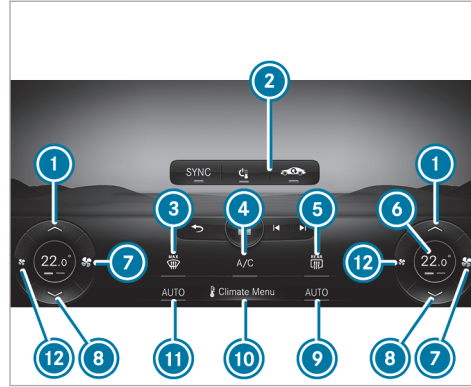

Front climate bar on the central display (example)

- ❶ Increases the temperature
- ❷ Upper display area of the climate bar with the examples of switching off climate control (→ page 167), switching air-recirculation mode on/off (→ page 170, 171) and **SYNC** synchronization function (→ page 170)
- ❸ Defrosts the windshield

- ❹ **A/C** Switches the A/C function on/off (→ page 168) or Fine particle prefilter status display (→ page 167)
 - ❺ Switches the rear window defroster on/off
 - ❻ Depending on vehicle equipment and settings: temperature display, display for pre-entry climate control or climate mode
 - ❼ Increases the airflow or switches on climate control (→ page 167)
 - ❽ Reduces the temperature
 - ❾ **AUTO** Sets climate control to automatic mode, right (→ page 168)
 - ❿ Calls up the air conditioning menu (→ page 167)
 - ⓫ **AUTO** Sets climate control to automatic mode, left (→ page 168)
 - ⓬ Reduces the airflow or switches off climate control (→ page 167)
- ❶ The climate bar will remain visible even when the vehicle is parked or the air conditioning is switched off (→ page 167).

- i The availability of individual functions depends on the country and equipment.

Overview of the rear operating unit

The rear operating unit is available only for vehicles with the THERMOTRONIC air conditioning control panel.

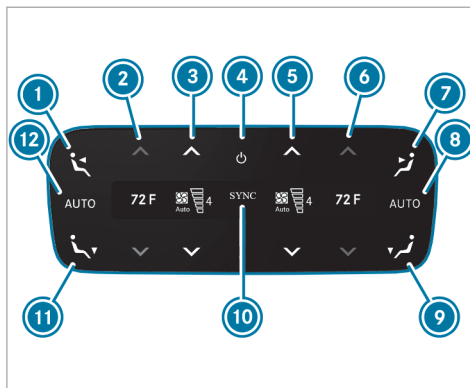

Example: USA

- ① Sets the air distribution to the rear left center vents
- ② Sets the temperature in the rear passenger compartment, left
- ③ Sets the airflow in the rear passenger compartment, left, or switches climate control on/off (→ page 167)

- ④ Switches climate control on/off (→ page 167)
- ⑤ Sets the airflow in the rear passenger compartment, right, or switches climate control on/off (→ page 167)
- ⑥ Sets the temperature in the rear passenger compartment, right
- ⑦ Sets the air distribution to the rear right center vents
- ⑧ Sets rear climate control to automatic mode, right
- ⑨ Sets the air distribution to the rear right footwell vents
- ⑩ Synchronization is activated (→ page 170)
- ⑪ Sets the air distribution to the rear left footwell vents
- ⑫ Sets rear climate control to automatic mode, left

The settings for the second row of seats can be configured via the rear operating unit or the multimedia system (→ page 170) depending on the vehicle's equipment.

Operating the climate control system

Switching climate control on/off

Switching on climate control

▶ Set the airflow to level 1 or higher via  on the climate bar on the central display

or

▶ Press **AUTO**,  or  or .

Switching off climate control

▶ Set the airflow to level 0 via  on the climate bar on the central display

or

▶ Press .

If climate control is switched off, the windows may fog up more quickly. Switch climate control off only briefly.

i If climate control is switched off via , **OFF** will be shown on the climate bar.

i When the range maximization function is activated, certain climate control functions are restricted and the window and mirror heaters are switched off. This can lead to windows fog up and reduced visibility due to weather con-

ditions. To quickly reactivate the climate control functions, press the  button on the climate bar on the central display.

Switching climate control on/off via the rear operating unit

Switching on

▶ Press the .

or

▶ Set the airflow to level 1 or higher using buttons  and .



or

▶ Press buttons , ,  or .

Switching off

▶ Press the .

or

▶ Set the airflow to level 0 using buttons  and .

i If rear climate control is switched off via button , **OFF** will be shown on the display.

Activating/deactivating the A/C function via the climate bar

The A/C function heats, cools and dehumidifies the vehicle's interior air.

▶ Press  on the climate bar on the central display.

i Switch off the A/C function only briefly; otherwise, the windows may fog up more quickly. Condensation may drip from the underside of the vehicle when cooling mode is active. This is not indicative of a malfunction.

Calling up the air conditioning menu using the climate bar

The air conditioning menu can be called up via the climate bar. The climate bar is always shown on the lower edge of the central display.

▶ Select the **Climate Menu** entry in the air conditioning bar.

The **First Row of Seats** menu is opened.

Jumping directly to the Air Quality menu



- ▶ Select the  fine particle prefilter status display in the air conditioning bar. The **Air Quality** menu is opened. An animation of the automatic air cleaning taking place is shown.
- ① The fine particle prefilter status display is on the home screen next to the temperature display on the right and it informs you of the current particulate levels inside and outside of the vehicle.
The measurement values are shown with the $\mu\text{g}/\text{m}^3$ units (micrograms per cubic meter).

Defrosting the windshield via the climate bar

Switching on

- ▶ Press  on the climate bar on the central display.

Switching off

- ▶ Press , **AUTO** or  on the climate bar on the central display

or

- ▶ set the airflow to 0.

- ① When the defrost function is activated, some functions (e.g. the temperature setting) will automatically be deactivated.

Activating/deactivating the A/C function via the air conditioning menu

Multimedia system:

↳ **Climate Menu** ▶ **First Row of Seats**

Depending on the external conditions, support for improved cooling and dehumidification of the interior air will be provided when the A/C function is activated. If it is not possible to operate the A/C function on the climate bar on the central display, switch the function on or off in the climate menu of the central display.

- ▶ Select **A/C** (A/C).

Setting climate control to automatic mode via the climate bar

In automatic mode, the set vehicle interior temperature is controlled automatically and maintained at a constant level by the air supply.

- ▶ Press **AUTO** on the climate bar on the central display.

- ① You can increase or reduce the airflow by pressing  on the climate bar on the central display.

- ▶ **To switch to manual operation:** switch off automatic mode or adjust an aspect of air distribution, e.g. .

Selecting climate modes via the air conditioning menu



Multimedia system:

↳ **Climate Menu** ▶ **First Row of Seats**

It is possible to switch between different climate modes on the Climate menu.

If ECO or ECO+ mode is activated, certain climate control functions will be restricted to conserve energy and extend the vehicle's range.

The following modes are available on the Climate menu:

- **Comfort:** maximum climate comfort
 - **ECO:** while heating and cooling output are limited, it remains possible to operate climate control without restriction. If you activate , the system will automatically switch to Comfort mode.
 - **ECO+:** mode using only the blower and waste heat, if applicable. The temperature can no longer be adjusted. If you activate , the system will automatically switch to Comfort mode.
- i** The windows may fog up more when ECO or ECO+ mode is activated.
- i** ECO+ climate mode can also be switched on and off via the range maximization button in the EQ menu under **Range**. When the range maximization function is deactivated, the system will automatically switch to the last selected

climate mode. Pressing the temperature or blower display on the climate bar of the central display allows direct access to the air conditioning menu when ECO or ECO+ mode is active. The climate mode can be changed by pressing the ECO button.

- i** The vehicle's climate control automatically detects seat occupancy. When the system switches to ECO or ECO+ mode, the climate control functions of the unoccupied seats are further restricted. If you activate , the system will automatically switch to Comfort mode.
- i** If the vehicle is parked for a short time while in ECO or ECO+ mode, the previously selected mode is still activated the next time the vehicle is started. If the vehicle is parked in ECO or ECO+ mode for a longer time, it will automatically switch to Comfort mode the next time it is started.
- ▶ Tap on **ECO**.
 - ▶ Select **Comfort, ECO** or **ECO+**.



If an ECO mode is selected via the air conditioning menu, two LEDs will appear on the tempera-

ture display on the climate bar. When ECO mode is switched on, one LED will light up green on the temperature display. When ECO+ mode is switched on, both LEDs will light up green and the ECO+ display will appear.

Setting air distribution using the air conditioning menu

Multimedia system:

➤ **Climate Menu**

- ▶ Select **First Row of Seats** or **Second Row of Seats**.
- ▶ To set the air distribution: select ,  or .
- ▶ Set the airflow.

- ⓘ When the air conditioning system is switched on, at least one zone is always active. However, several air distribution options can be selected at the same time, for example to set the climate control for the interior and the footwells simultaneously. In doing so, the  climate control for the windshield can only be selected for the first seat row. When automatic mode is active, the buttons for setting the air distribution are automatically deactivated. When the air conditioning system is switched off, the buttons remain operable and the last setting is saved.

Setting rear climate control using the air conditioning menu



Multimedia system:

➔ Climate Menu



Setting the temperature

- ▶ Select **Second Row of Seats**.
- ▶ Set the temperature.

Sets the airflow

- ▶ Select **Second Row of Seats**.
- ▶ Set the air flow with  or .

Controlling rear climate control automatically

- ▶ Select **AUTO**.
- ⓘ When the defrost function is activated, some functions (e.g. the temperature setting) will automatically be deactivated. To deactivate the defrost function, press either , **AUTO** or  set the air flow to level 0 (→ page 168).

Switching the synchronization function on/off via the air conditioning menu

Multimedia system:

➔ Climate Menu ➔ First Row of Seats

The synchronization function controls the climate control centrally. The driver's settings for temperature, airflow and air distribution are automatically adopted for each climate zone.

- ▶ Select **SYNC** (SYNC).

Removing condensation from the windows

Windows fogged up on the inside

- ▶ Press **AUTO** on the climate bar on the central display.
- ▶ If the windows remain fogged up: press  on the climate bar on the central display.

Windows fogged up on the outside

- ▶ Switch on the windshield wipers.
- ▶ Press **AUTO** on the climate bar on the central display.

Switching the air-recirculation mode on/off via the air conditioning menu

Requirements:

- The THERMATIC air conditioning control panel with fine particle prefilter is available.
- The THERMOTRONIC air conditioning control panel with or without fine particle prefilter is available.

Multimedia system:

→ Climate Menu → First Row of Seats

- ▶ Press  in the upper display area of the climate bar.
The interior air will be recirculated.

Air-recirculation mode will automatically switch to fresh air mode after a while.

- ① If air-recirculation mode is switched on, the windows may fog up more quickly. Switch on air-recirculation mode only briefly.
- ① By selecting the fine particle status display  on the climate bar, you can jump directly to the air quality menu.

Switching air-recirculation mode on/off via the climate bar

Requirements:

- The THERMATIC air conditioning control panel without fine particle prefilter is available.
- ▶ Press  on the climate bar on the central display.
The interior air will be recirculated.

Air-recirculation mode will automatically switch to fresh air mode after a while.

- ① If air-recirculation mode is switched on, the windows may fog up more quickly. Switch on air-recirculation mode only briefly.

Activating or deactivating ionization via the air conditioning menu

Multimedia system:

→ Climate Menu → Air Quality

When ionization is activated, the indoor air is enriched with negatively charged oxygen ions. This can promote the well-being of the vehicle occupants.

- ▶ Select **Ionization**.
- ① The function can only be performed if the AUTO mode is activated or the air distribution is set to the side air vent. The function is restricted if the side air vent on the driver's side is closed.

Fragrance system

Activating/deactivating the fragrance system using the multimedia system

Requirements

- Automatic climate control is activated.
- The glove box will close.
- A flacon is inserted.

Multimedia system:

→ Climate Menu → Air Quality

The fragrance system distributes a pleasant fragrance throughout the vehicle interior from a flacon located in the glove box.

- ▶ Navigate down until the climate control bar is active.
- ▶ Select **Fragrance**.
- ▶ Activate or deactivate fragrancing.

Setting the fragrance system using the multimedia system

Requirements

- A flacon is inserted.

- The glove box will close.
- Climate control is activated.

Multimedia system:

→ [Climate Menu](#) → [Air Quality](#)

The fragrance system distributes a pleasant fragrance throughout the vehicle interior from a flacon located in the glove box.

- ▶ Select [Fragrance](#).
- ▶ Keep pressing until the desired intensity is reached.

Inserting or removing the flacon of the fragrance system

⚠ WARNING Risk of injury from liquid perfume

If children open the flacon, they could drink the liquid perfume or it could come into contact with their eyes.

- ▶ Do not leave children unattended in the vehicle.

- ▶ Consult a doctor immediately if liquid perfume has been drunk.
- ▶ If liquid perfume comes into contact with your eyes or skin, rinse your eyes with clean water.
- ▶ If symptoms continue, consult a doctor.

🔥 ENVIRONMENTAL NOTE Environmental damage due to improper disposal of full flacons



Full flacons must not be disposed of with household waste.



Full flacons must be taken to a harmful substance collection point.

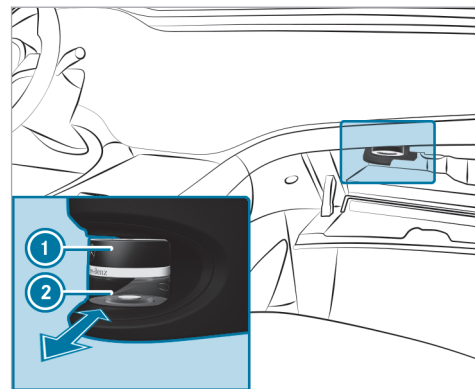

- ① Cap
- ② Flacon

- ▶ **To insert:** slide the flacon into the holder as far as it will go.
- ▶ **To remove:** after opening the glove box, wait for approximately seven seconds and pull out the flacon.

If you do not use genuine Mercedes-Benz interior perfumes, observe the manufacturers' safety notices on the perfume packaging.

Dispose of the genuine Mercedes-Benz interior perfume flacon when it is empty and do not refill it.

Refillable flacon

- ▶ Unscrew the cap of the empty flacon.
- ▶ Fill the flacon with a maximum of 0.5 fl. oz. (15 ml).
- ▶ Screw the cap back onto the flacon.

Always refill the empty refillable flacon with the same perfume. Observe the separate information sheet with the flacon.

Information on the windshield heater

⚠ WARNING Risk of burns from touching the windshield when the windshield heater is switched on

The windshield can become very hot when the windshield heater is switched on.

The health of persons with limited temperature sensitivity or a limited ability to react to high temperatures may be affected or they may even suffer burn-like injuries.

- ▶ Do not touch the windshield while the windshield heater is switched on.
- ▶ Allow the windshield to cool down before touching it.

The windshield heater will be enabled automatically if  is activated on the climate bar on the central display.

After the vehicle is started, the windshield heater will be switched on automatically as required.

- ⓘ If the on-board electrical system voltage is low, the function of the windshield heater may be impaired.

Pre-entry climate control when the vehicle is unlocked

■ Function of pre-entry climate control when the vehicle is unlocked

The seats can be briefly pre-warmed or pre-cooled before you get into the vehicle.

Depending on the vehicle's equipment, the following functions will be activated as needed during pre-cooling:

- Automatic climate control
- Blower
- Seat ventilation

Depending on the vehicle's equipment, the following functions will be activated as needed during pre-warming:

- Automatic climate control
- Blower
- Seat heating
- Steering wheel heating
- Mirror heater
- Rear window defroster

- Windshield heater
- Wiper park position heater

Depending on the vehicle's equipment, the following functions will also be adjusted during pre-entry climate control if they have already been switched on during regular vehicle operation:

- Fragrancing
- Ionization

■ Setting pre-entry climate control when the vehicle is unlocked in the multimedia system

Multimedia system:

↳ Climate Menu ▶▶ Pre-entry Climate Ctrl.

- ▶ Activate or deactivate the function.

Selecting seats

- ▶ Select **Driver**, **Passenger**, **Rear Left** or **Rear Right**.

The seat-specific functions of pre-entry climate control, such as seat heating, will be performed for the selected seats.

If pre-entry climate control is enabled, an LED on the climate bar of the central display will light up

blue for a cooled vehicle and red for a heated vehicle.

■ Activating/deactivating pre-entry climate control when the vehicle is unlocked

Requirements

- The high-voltage battery is charged sufficiently.
- The function has been activated via the multimedia system.

- ▶ **To switch on:** unlock the vehicle. The climate control functions are activated for up to five minutes for pre-heating and pre-cooling.

Pre-entry climate control via unlocking cannot be activated more than three times in succession when the vehicle is switched off.

- ▶ **To switch off:** press  on the climate bar on the central display.

The following functions will remain active once the vehicle has been started:

- Seat heating

- Seat ventilation

Depending on the vehicle's equipment, the following functions will also be adjusted during pre-entry climate control if they have already been switched on during regular vehicle operation:

- Fragrancing
- Ionization

Pre-entry climate control for departure time

■ Pre-entry climate control for departure time function

▲ WARNING Risk of fatal injury due to exposure to extreme heat or cold in the vehicle

If persons, particularly children, are subjected to prolonged exposure to intense heat or cold, there is a risk of severe injury or even death.

- ▶ Never leave persons, particularly children, unattended in the vehicle.

⚠ WARNING Risk of burns due to repeatedly switching on the seat heating

Repeatedly switching on the seat heating can cause the seat cushion and seat backrest padding to become very hot.

In particular, the health of persons with limited temperature sensitivity or a limited ability to react to high temperatures may be affected or they may even suffer burn-like injuries.

- ▶ Do not repeatedly switch on the seat heating.

To protect against overheating, the seat heating may be temporarily deactivated after it has been switched on repeatedly.

The air inside the vehicle can be heated, ventilated or cooled to the set temperature when the vehicle is parked.

When the vehicle is connected to power supply equipment, priority will be given to charging the high-voltage battery to a specified minimum charge.

The running time of pre-entry climate control may be reduced in the following circumstances:

- The vehicle is not connected to power supply equipment.
- The high-voltage battery is not fully charged.

With active pre-entry climate control, the charge level of the high-voltage battery may be reduced, even if the charging cable connector is connected.

If present, seat ventilation will be activated in cooling and ventilation modes.

If present, the following functions will be activated in heating mode:

- Seat heating
- Steering wheel heating
- Mirror heater
- Rear window defroster
- Windshield heater
- Wiper park position heater

When the set temperature is changed, the climate control mode will automatically be updated. It will

be switched from heating mode to ventilation or cooling mode, from cooling mode to ventilation or heating mode or from ventilation mode to heating or cooling mode.

Depending on the vehicle's equipment, the following functions will also be adjusted during pre-entry climate control if they have already been switched on during regular vehicle operation:

- Fragrancing
- Ionization

■ Setting pre-entry climate control for departure time via the climate bar

Multimedia system:

↳ Climate Menu ▶ Pre-entry Climate Ctrl.

Setting the departure time

- ① The set departure times are used for the vehicle's pre-entry climate control and for predictions regarding the approximate state of charge and range at the time selected. Additional information on the charging settings (→ page 216).

▶ Select **Edit Departure Time** .

- ▶ Select a departure time or set a new departure time.
- ⓘ If the range maximization function is activated, an approximate time for reaching the desired state of charge will be determined automatically during a charging stop. This is used as an approximate departure time for pre-entry climate control and is set automatically. Departure times previously set cannot be edited when the function is switched on. The automatically determined departure time can be activated or deactivated via the air conditioning menu.

Setting the repeat days

- ▶ Select **Edit Departure Time** .
- ▶ Set the desired departure time and select the corresponding weekdays on which this departure time is to apply.
- ▶ Press **OK** to confirm.

Selecting seats

- ▶ Select **Driver, Passenger, Rear Left** or **Rear Right**.
Pre-entry climate control will take place for the selected seats.

If a departure time is set, a yellow LED will appear on the climate bar of the central display. In addition, an LED on the climate bar will indicate when pre-entry climate control is activated. It will light up blue when the vehicle is being cooled and red when it is being heated.

■ Activating/deactivating pre-entry climate control for departure time

Requirements

- The high-voltage battery is charged sufficiently.
- The function has been activated via the multimedia system.
- ▶ **To activate:** set the departure time (→ page 175).
Pre-entry climate control for departure time will switch on a maximum of 55 minutes

before the selected departure time. It will remain active for another five minutes if departure is delayed.

- ▶ **To deactivate the pre-entry climate control for departure time early:** press  on the climate bar on the central display or switch off the preselection of the time on the climate menu.

Depending on the vehicle equipment, the following functions will remain active once the vehicle has been started:

- Seat heating
- Seat ventilation

Depending on the vehicle's equipment, the following functions will also be adjusted during pre-entry climate control if they have already been switched on during regular vehicle operation:

- Fragrancing
- Ionization

Operating immediate pre-entry climate control via the climate bar

⚠ WARNING Risk of fatal injury due to exposure to extreme heat or cold in the vehicle

If persons, particularly children, are subjected to prolonged exposure to intense heat or cold, there is a risk of severe injury or even death.

- ▶ Never leave persons, particularly children, unattended in the vehicle.

⚠ WARNING Risk of burns due to repeatedly switching on the seat heating

Repeatedly switching on the seat heating can cause the seat cushion and seat backrest padding to become very hot.

In particular, the health of persons with limited temperature sensitivity or a limited ability to react to high temperatures may be affected or they may even suffer burn-like injuries.



- ▶ Do not repeatedly switch on the seat heating.

To protect against overheating, the seat heating may be temporarily deactivated after it has been switched on repeatedly.

Requirements

- The vehicle is switched off.

Air conditioning of the vehicle interior can continue for up to 50 minutes, e.g. if the journey is interrupted.

- ▶ Press the  button on the climate bar on the central display.
- ▶ Set the temperature using the  and  arrows on the climate bar on the central display.

An LED on the climate bar on the central display indicates when pre-entry climate control is activated. It will light up blue when the vehicle is being cooled and red when it is being heated.

Air vents

Adjusting the front air vents

⚠ WARNING Risk of burns or frostbite due to being too close to the air vents

Very hot or very cold air can flow from the air vents.

- ▶ Make sure that all vehicle occupants always maintain a sufficient distance from the air vents.
- ▶ If necessary, direct the airflow to another area of the vehicle interior.

To guarantee the flow of fresh air through the air vents into the vehicle interior, note the following:

- Always keep the vents and ventilation grilles in the vehicle interior clear.
- Keep the air inlet grilles free of residue build-up (→ page 381).

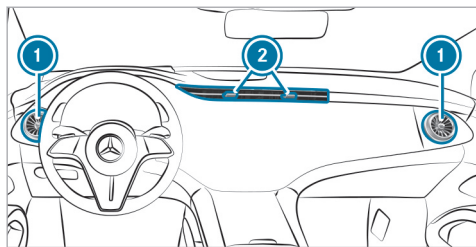

- ▶ **To open or close the side air vents:** hold the outer ring of side air vent ① and turn it to the left or right as far as it will go.
- ▶ **To open or close the center air vent:** move controller ② inwards or outwards as far as it will go.
- ▶ **To adjust the airflow direction of the side air vents:** hold the center of side air vent ① and move it up or down or to the left or right.
- ▶ **To adjust the airflow direction of the center air vent:** hold the controller of center air vent ② and move it up or down or to the left or right.

Adjusting the rear air vents

⚠ WARNING Risk of burns or frostbite due to being too close to the air vents

Very hot or very cold air can flow from the air vents.

- ▶ Make sure that all vehicle occupants always maintain a sufficient distance from the air vents.
- ▶ If necessary, direct the airflow to another area of the vehicle interior.

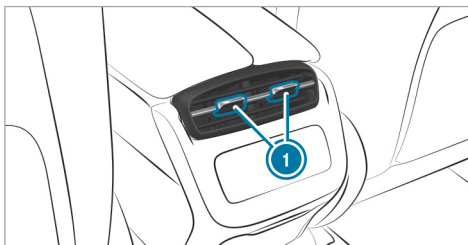

- ▶ **To open or close the rear air vents:** hold the controller of rear air vent ① and move it inwards or outwards as far as it will go.
- ▶ **To set the airflow direction of the rear air vents:** hold controller ① and move it up or down or to the left or right.

Driving

Notes on Mercedes-AMG vehicles

Observe the notes on the following topics in the Supplement, otherwise you may fail to recognize dangers.

- ① The availability of certain functions depends on the equipment and model of the vehicle.
 - AMG Active Sound
 - AMG ceramic high-performance composite brake system
 - RACE START
 - AMG RIDE CONTROL +
 - AMG steering-wheel buttons

Notes on electric mode

⚠ WARNING Risk of chemical burns and poisoning from damaged high-voltage battery

If the housing of the high-voltage battery has been damaged, electrolyte and gases may leak out.

- ▶ Avoid contact with the skin, eyes or clothing.
- ▶ Immediately rinse electrolyte splashes off with water and seek medical attention straight away.

⚠ DANGER Risk of fire and explosion from excessive internal pressure of the high-voltage battery

In the event of a vehicle fire, flammable gas can escape and ignite.

- ▶ If there is an unusual smell, smoke or burn marks, stop the charging process immediately.
- ▶ Leave the danger zone immediately. Secure the danger area at a sufficient distance.
- ▶ Call the fire service.

Observe the following notes on vehicle noise emissions and the acoustic vehicle alerting system:

- The vehicle is equipped with an all-electric drive system and produces considerably lower stationary and vehicle noise emissions than a vehicle with a combustion engine.

For this reason the vehicle is equipped with a sound generator, which serves as an acoustic vehicle alerting system (AVAS). This safety device is prescribed by law.

The external noise of the sound generator is perceptible in the vehicle interior when the vehicle is stationary and at low speeds and does not represent a malfunction.

- The sound generator generates stationary noise and speed-dependent vehicle noise emissions up to a speed of around 25 mph (30 km/h).

This helps other road users, particularly pedestrians and cyclists, to hear your vehicle better.

- When you drive at speeds above 20 mph (20 km/h) the acoustic vehicle alerting system will gradually switch off.
- Despite the sound generator, the vehicle still may not be heard by other road users. Adapt your driving style accordingly.

Manually disconnecting the high-voltage on-board electrical system

⚠ DANGER Risk of death and fire due to modified and/or damaged components of the high-voltage on-board electrical system

The vehicle's high-voltage on-board electrical system is under high voltage. If you modify component parts in the vehicle's high-voltage on-board electrical system or touch damaged component parts, you may be electrocuted. In addition, modified and/or damaged components may cause a fire.

In the event of an accident or impact to the vehicle underbody, components of the high-

voltage electrical system may be damaged although the damage is not visible.

- ▶ Never make any modifications to the high-voltage on-board electrical system.
- ▶ Do not switch on or use the vehicle if its high-voltage on-board electrical system components have been modified or damaged.
- ▶ Never touch damaged components of the high-voltage on-board electrical system.
- ▶ After an accident, do not touch any components of the high-voltage on-board electrical system.
- ▶ After an accident, have the vehicle transported away.
- ▶ Have the components of the high-voltage on-board electrical system checked at a qualified specialist workshop and replaced if necessary.

Requirements

Disconnect the high-voltage on-board electrical system manually only in the following situations:

- The  restraint system warning lamp lights up on the driver's display, e.g. after an accident.
- The vehicle is badly damaged, e.g. after an accident, and the restraint system components have not been triggered.

Operating the high-voltage disconnect device

Disconnect the high-voltage on-board electrical system manually only in the above-mentioned situations.

- ▶ Switch off the vehicle.
- ▶ Shift the transmission to position **P**.
- ▶ Apply the electric parking brake.
- ▶ Secure the vehicle against rolling away.

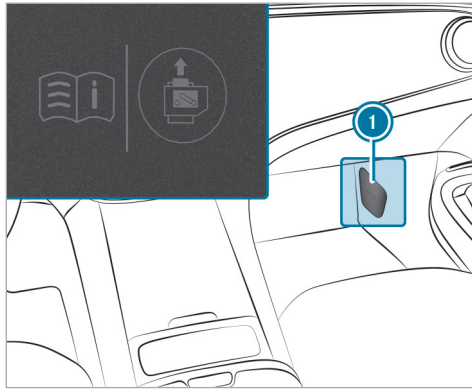

- ▶ Remove flap ① of the fuse box in the front passenger footwell.

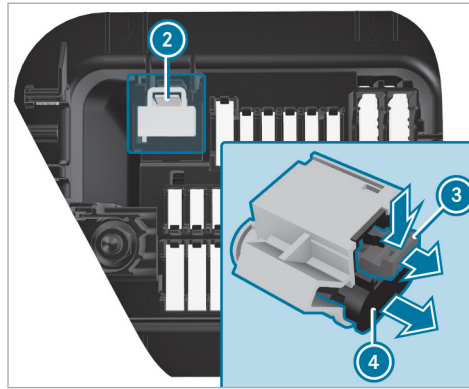

- ▶ Press release tab ③ on high-voltage disconnect device ② in the direction of the arrow and pull it out.
- ▶ Pull connector ④ in the direction of the arrow until it engages.
The high-voltage on-board electrical system will be switched off.

All work on the drive system (including after the high-voltage on-board electrical system has been

disconnected manually) may be carried out only at a qualified specialist workshop.

Switching on the power supply or the vehicle

⚠ WARNING Risk of accident and injury due to children left unattended in the vehicle

If you leave children unattended in the vehicle, they could, in particular:

- open doors, thereby endangering other persons or road users.
- get out and be struck by oncoming traffic.
- operate vehicle equipment and become trapped, for example.

In addition, the children could also set the vehicle in motion by, for example:

- releasing the parking brake.
- changing the gearbox position.
- starting the vehicle.

▶ Never leave children unattended in the vehicle.

- ▶ When leaving the vehicle, always take the key with you and lock the vehicle.
- ▶ Keep the key out of reach of children.

This also applies to the Digital Vehicle Key.

Requirements

- The key is in the vehicle and is recognized.
- **Vehicles with Digital Vehicle Key:** a Digital Vehicle Key with drive authorization is detected.
- The brake pedal is not depressed.

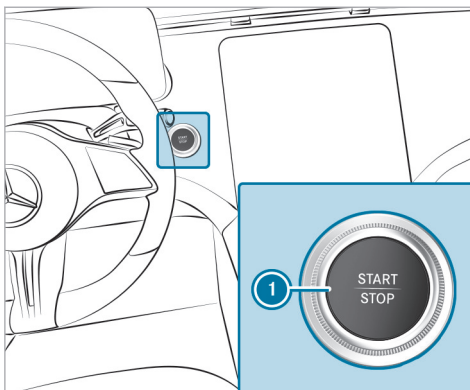

Vehicles with central display

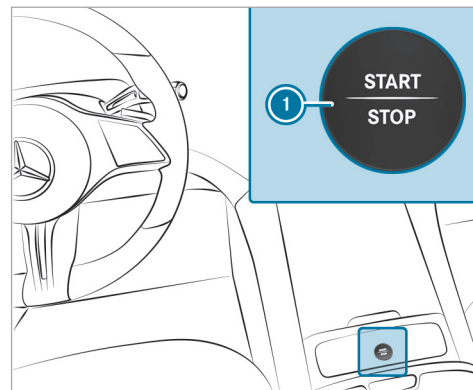

Vehicles with MBUX Hyperscreen

- ▶ **To switch on the power supply:** press button ① once.
You can, for example, switch on the windshield wipers.

The power supply will be switched off again if the following conditions are met:

- You open the driver's door.

- You press button ❶ twice more.

▶ **To switch on the vehicle:** press button ❶ twice.
Indicator and warning lamps will light up on the driver's display.

The vehicle will be switched off again if one of the following conditions is met:

- You do not start the vehicle within 15 minutes and the transmission is in position **P** or the electric parking brake is applied.
- You press button ❶ once.

Starting the vehicle

▶ Starting the vehicle with the start/stop button

Requirements

- The key is in the vehicle and is recognized.
 - **Vehicles with Digital Vehicle Key:** a Digital Vehicle Key with drive authorization is detected.
- ▶ Shift the transmission to position **P** or **N**.

▶ Depress the brake pedal and press button ❶ once.

- The vehicle will be started.
- The **READY** display appears on the driver's display: the vehicle can be driven.

▶ If the vehicle does not start: switch off non-essential consumer equipment and press button ❶ once.

▶ If the vehicle still does not start and the **Place the Key in the Marked Space See Operator's Manual** display message appears on the driver's display: start the vehicle with the key in the marked space (emergency operation mode) (→ page 184).

❶ You can switch off the vehicle while driving. To do this, press and hold button ❶ for about three seconds or press button ❶ three times within three seconds. The transmission will shift to neutral **N** automatically. When you press button ❶ again, the vehicle will start again and you can engage drive position **D** again. Be sure to observe the safety notes concerning this under "Driving tips" (→ page 185).

Observe any information regarding display messages that may be shown on the driver's display.

▶ Starting the vehicle with the Digital Vehicle Key in the marked space (emergency operation mode)

Requirements

- The vehicle is equipped with the "Digital Vehicle Key" pre-installation.
- A suitable end device is activated as a Digital Vehicle Key.

❶ Mercedes-Benz recommends that you carry the emergency key in case of function restrictions.

If the vehicle does not start and the **Place Smart-Key in Cup Holder or Digital Vehicle Key in Mobile Phone Cradle See Operator's Manual** display message appears on the driver's display, you can start the vehicle in emergency operation mode.

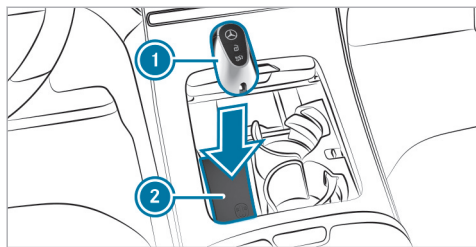

- ▶ Place key ① in stowage compartment ②.

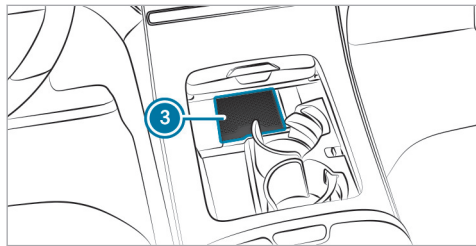

- ▶ Place the Digital Vehicle Key marked space ③.

- ▶ Depress the brake pedal and start the vehicle using the start/stop button. It may take a few seconds until the vehicle starts.
- ▶ When the **Key Not Detected** display message appears on the driver display, press the Start/Stop button again.

When the **READY** display appears on the driver display, the vehicle can be driven.

Starting the vehicle with the key in the marked space (emergency operation mode)

This also applies to the Digital Vehicle Key. If the vehicle does not start and the **Place the Key in the Marked Space See Operator's Manual** display message appears on the driver's display, you can start the vehicle in emergency operation mode.

Vehicles with Digital Vehicle Key: if the vehicle does not start and the **Place SmartKey in Cup Holder or Digital Vehicle Key in Mobile Phone Cradle See Operator's Manual** display message appears on the driver's display, you can start the vehicle in emergency operation mode.

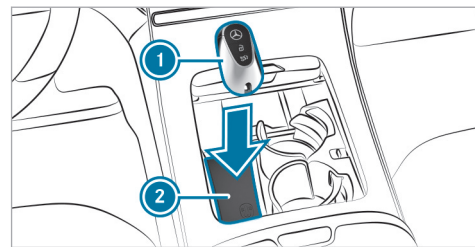

- ▶ Make sure that marked space ② is empty.
- ▶ Remove key ① from the key ring.
- ▶ Place key ① on the symbol in marked space ②. The vehicle will start after a short time. If you remove key ① from marked space ②, the vehicle can still be driven. For further engine starts, however, key ① must be located on the symbol in marked space ② during the entire trip.
- ▶ Have key ① checked at a qualified specialist workshop.

If the vehicle does not start:

- ▶ Place key ① in marked space ② and leave it there.
- ▶ Depress the brake pedal and start the vehicle using the start/stop button.
- ① You can switch on the power supply or the vehicle with the start/stop button.

Observe any information regarding display messages that may be shown on the driver's display.

Notes on breaking-in a new vehicle

- In certain handling and driving safety systems, the sensors adjust automatically while a certain distance is being driven after the vehicle has been delivered or after repairs. Full system effectiveness is reached only when this teaching-in process has concluded.
- Brake pads, brake disks and tires that are either new or have been replaced achieve optimum braking effect and grip only after several hundred kilometers. Compensate the reduced braking effect by applying greater force to the brake pedal.

Notes on acceleration increase

- ① Acceleration increase is not available for all models and versions.
- ① This function is an on-demand feature (→ page 29).

When the function is activated, a higher maximum power is available for the vehicle and the acceleration characteristics are improved. This does not change the maximum design speed of the vehicle.

Due to the increased power, there may be changes in the electric range.

Notes on driving

⚠ WARNING Risk of accident due to objects in the driver's footwell

Objects in the driver's footwell may impede pedal travel or block a depressed pedal.

This jeopardizes the operating and road safety of the vehicle.

- ▶ Stow all objects in the vehicle securely so that they cannot get into the driver's footwell.
- ▶ Always install the floor mats securely and as prescribed in order to ensure that there is always sufficient room for the pedals.
- ▶ Do not use loose floor mats and do not place floor mats on top of one another.

⚠ WARNING Risk of accident due to incorrect footwear

Incorrect footwear includes, for example:

- Shoes with platform soles
- Shoes with high heels
- Slippers

There is a risk of an accident.

- ▶ Always wear suitable footwear so that you can operate the pedals safely.

⚠ WARNING Risk of accident if the vehicle is switched off while driving

If you switch off the vehicle while driving, safety functions are restricted or no longer available.

This may affect the power steering system and the brake force boosting, for example.

You will need to use considerably more force to steer and brake, for example.

- ▶ Do not switch off the vehicle while driving.

⚠ WARNING Risk of accident and injury due to being under the influence of alcohol and drugs while driving

Drinking and driving and/or taking drugs and driving are very dangerous combinations. Even a small amount of alcohol or drugs can affect your reflexes, perceptions and judgment.

The possibility of a serious or even fatal accident are greatly increased when you drink or take drugs and drive.

- ▶ Do not drink or take drugs and drive or allow anyone to drive who has been drinking or taking drugs.

⚠ WARNING Risk of accident due to the brake system overheating

If you leave your foot on the brake pedal when driving, the brake system may overheat.

This increases the braking distance and the brake system can even fail.

- ▶ Never use the brake pedal as a footrest.
- ▶ Do not depress the brake pedal and the accelerator pedal at the same time while driving.

! NOTE Damage to the vehicle due to not observing the maximum permitted headroom clearance

If the vehicle height is greater than the maximum permitted headroom clearance, the roof and other parts of the vehicle may be damaged.

- ▶ Observe the signposted headroom clearance.
- ▶ If the vehicle height is greater than the permitted headroom clearance, do not enter.
- ▶ Observe the changed vehicle height with add-on roof equipment.

i Please bear in mind that all the speed values stated in this Operator's Manual are approximate and are subject to a certain tolerance.

Notes on driving with a roof load, trailer or fully laden vehicle

When driving with a loaded roof luggage rack or trailer as well as with a fully laden or fully occupied vehicle, the vehicle's driving and steering characteristics change.

You should therefore bear the following in mind:

- Do not exceed the permissible roof load and towing capacity. Also observe the information in the Technical Data.
- Distribute the roof load and the load inside the vehicle evenly, placing heavy objects at the

bottom. Also comply with the notes on loading the vehicle (→ page 124).

- Drive attentively, and avoid abrupt starts, braking and steering as well as rapid cornering.

Advice on driving on salt-strewn roads

The braking effect is limited on salt-strewn road surfaces.

Therefore, observe the following notes:

- Due to salt build-up on the brake disks and brake pads, the braking distance can increase considerably or result in one-sided braking.
- Maintain a much greater safety distance to the vehicle traveling in front.

Remove salt build-up as follows:

- Brake occasionally, paying attention to the traffic conditions
- Carefully depress the brake pedal at the end of the journey and when starting the next journey

Notes on hydroplaning

Hydroplaning can take place if a certain depth of water has built up on the road surface.

Observe the following notes during heavy precipitation or in conditions in which hydroplaning may occur:

- Reduce speed
- Avoid tire ruts
- Avoid sudden steering movements
- Brake carefully

i Also observe the notes on regularly checking wheels and tires (→ page 409).

Notes on driving through water on the road

Water ingress can damage the drive system, electronics and transmission.

Observe the following if you have to drive through water:

- The water, when calm, may reach no higher than the lower edge of the vehicle body.
- Drive at walking pace at most; water may otherwise enter the vehicle interior.
- Vehicles traveling in front, or oncoming vehicles, can create waves which may exceed the maximum permissible depth of water.

The braking effect of the brakes is reduced after fording. Brake carefully, paying attention to the traffic conditions until braking power has been fully restored.

Function of rear axle steering

The rear axle steering is an electromechanical auxiliary steering on the rear axle which adjusts the steering of the rear wheels according to the position of the front wheels, depending on the speed. This results in greater maneuverability and improved driving stability, e.g. when cornering. Rear axle steering has the following characteristics:

- reduced steering effort and turning circle resulting in reduced parking effort
- improved driving stability, e.g. when cornering
- more direct steering resulting in improved handling of the vehicle

Observe the notes on snow chains and snow chain mode (→ page 410).

Notes on off-road driving

⚠ WARNING Risk of accident if you do not keep to line of fall on inclines

If you drive at an angle or turn on an incline, the vehicle could slip sideways, tip and roll-over.

▶ Always drive on inclines in the line of fall (straight up or down) and do not turn.

When you drive off-road, sand, mud and water or water mixed with oil etc. may get into the brakes. This may lead to a reduction in braking performance or even a total brake failure as a result of increased wear. The braking characteristics will vary depending on the material that has entered the system. Clean the brakes after driving off-road. If you then notice reduced braking performance or hear scraping noises, have the brake system checked at a qualified specialist workshop. Adapt your driving style to the changed braking characteristics.

! **NOTE** Damage caused by driving over obstacles

The vehicle can be damaged by:

- Driving onto high curbs or unpaved roads.
- Quickly driving over obstacles such as curbs, speed bumps or potholes.
- Heavy objects hitting the underbody or chassis components.

- ▶ Do not drive over obstacles that could damage the vehicle.
- ▶ Check the vehicle regularly for damage during off-road driving.
- ▶ Adjust the vehicle speed to suit the road surface conditions.
- ▶ If there is damage, consult a qualified specialist workshop immediately.

🔥 ENVIRONMENTAL NOTE Environmental damage due to non-observance of prohibition signs

Environmental protection has priority. Treat nature with respect.

▶ Be sure to observe prohibition signs.

- i** The vehicle is designed for easily negotiable and moderate off-road terrain. When driving off-road, make sure there is sufficient ground clearance. The high-voltage battery in particular can be damaged by bottoming out or by impacts against the underbody. Please also observe the notes on operating safety (→ page 31).

Checklist before driving off-road

Check the following points before driving off-road:

- State of charge of the high-voltage battery
- Tire-change tool kit and spare wheel
- Tires and wheels

- ① Further information about special all-terrain tires for retrofitting can be obtained from a qualified specialist workshop.

Off-road driving

Read this section before driving your vehicle off-road. Practice by driving over gentler off-road terrain first.

- Observe the notes on the cross-country ABS (→ page 227).
- Select the  (→ page 196) drive program before driving off-road.

To avoid damaging the vehicle, make sure there is always sufficient ground clearance.

Vehicles with AIRMATIC: The vehicle is automatically raised by 1 in (25 mm) to the off-road level.

- Drive on downhill gradients and slopes only with the vehicle started and only in **D** or **R**. Observe the notes on driving in mountainous terrain.
- Do not drive on unknown terrain that is not easily visible and stay on marked paths.

- Always keep the doors and windows closed while the vehicle is in motion.
- Deactivate Active Distance Assist DISTRONIC and cruise control.
- Adapt your driving style to the terrain.
- Do not use the HOLD function on steep downhill or uphill gradients with slippery or loose surfaces.

Driving on sand

When driving on sand, also observe the following instructions:

- Drive quickly to overcome the rolling resistance; the vehicle may otherwise dig itself in.
- Drive in the tracks of other vehicles if possible. Make sure that the following prerequisites are met:
 - the tire ruts are not too deep.
 - the sand is firm enough.
 - there is sufficient ground clearance.

Fording

Also observe the following information when fording:

- Do not exceed 6 mph (10 km/h).
- The water, when calm, may reach no higher than the lower edge of the vehicle body.
- Switch off automatic climate control (→ page 168).
- Ensure that a bow wave does not form as you drive.
- Do not stop in the water.

Driving in mountainous terrain

Also observe the following information when driving in mountainous terrain:

- When driving downhill, use the recuperation level **D**  of the regenerative brake system (→ page 191).
- Activate DSR before driving downhill, if necessary (→ page 244).

Checklist after driving off-road

Driving off-road places greater demands on your vehicle than driving on normal roads. Check the entire vehicle for damage and foreign bodies

every time after driving off-road. Foreign bodies in the wheels or drivetrain can lead to imbalances and therefore vibrations.

- If the  driving mode is selected: select another driving mode.

Vehicles with AIRMATIC: The vehicle will be lowered to the normal level.

- Deactivate DSR.
- Apply the brakes to dry them after fording.
- Check that the service brake is working normally after a long downhill stretch.
- Clean the following components every time after driving off-road:
 - license plate number
 - headlamps and tail lamps
 - tires, wheels and wheel arches
 - underbody
- After driving through sand, mud, water or gravel, have the following components checked and cleaned:
 - brake disks and brake pads
 - tires and wheels

- axle joints

ECO display function

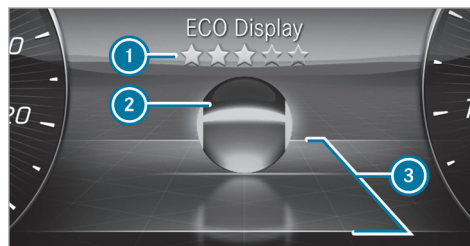

The ECO display shows an evaluation of your driving style on the driver's display depending on the situation. This enables you to check the efficiency of your driving style and adjust it if necessary. The **ECO Display** menu shows a ball (2) that will roll forwards or backwards on a stylized road in the direction of travel according to the driving characteristics.

Above and below the road, lines mark the area for an efficient driving style (3). Ball (2) will light up in

green if it is rolling within these lines. Outside the lines, the ball will light up in orange.

The ECO display assesses the following criteria for an economical driving style:

- Coasting at the right times
- Consistent speed
- Moderate acceleration

The overall assessment of your driving style "from start" is indicated using stars (1). It starts with five empty stars, which you can fill one after the other if you drive efficiently. When all five stars are filled, a glow will appear in the background.

- You can call up the **ECO Display** function via the **Classic** menu (→ page 311).

Recuperative brake system

Function of the recuperative brake system

Depending on the selected recuperation level, the electric motors will be operated as an alternator when in overrun mode and during braking in order to charge the high-voltage battery during driving. As soon as you take your foot off the accelerator

pedal when the vehicle is in motion and in transmission position **D**, recuperation in overrun mode will be initiated.

The higher the recuperation, the stronger the braking effect will be during coasting and the more electrical energy will be fed into the high-voltage battery.

The deceleration in overrun mode may not be sufficient depending on the driving conditions. Also brake with the service brake if necessary. Always adapt your speed to the driving conditions and keep a sufficient distance.

The recuperative brake system has the following characteristics:

- supports braking with electronically controlled brake force boosting
- converts the kinetic energy of the vehicle into electric energy

i If you brake hard, the mechanical brake will also be used. This means that the maximum recuperative energy cannot be recovered. The more you drive and brake in an anticipatory

manner, the more efficiently energy can be recuperated.

System limits

The braking effect of the electric motor during recuperation in overrun mode may be reduced or may not be available at all in the following situations:

- when the high-voltage battery state of charge increases
- if the high-voltage battery is not yet at a normal operating temperature

In these cases, the desired deceleration will be set by the brake control system.

Manually setting recuperative deceleration

You can use the steering wheel paddle shifters to manually adjust the intensity of recuperation in overrun mode.

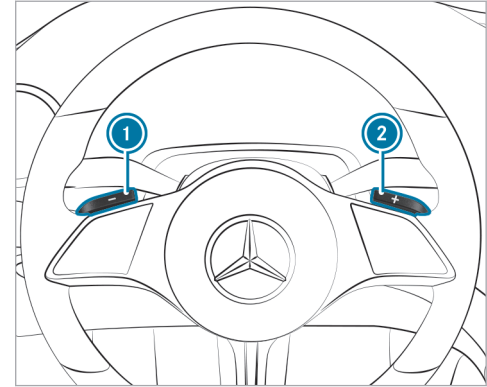

i When the vehicle is started again, **D** is automatically set as the recuperation level.

The following recuperation levels are available:

- **D** **AUTO** Intelligent and anticipatory recuperation with ECO Assist (→ page 192)
- **D** **+** No recuperation: the vehicle coasts, rolls freely
- **D** Normal recuperation (standard setting)

- **[D] [-]** Increased recuperation: increased deceleration in overrun mode

▶ **To increase recuperation:** briefly pull paddle shifter ①.

▶ **To reduce recuperation:** briefly pull paddle shifter ②.

▶ **To select [D] AUTO:** If **[D] +** has been selected, briefly pull paddle shifter ②. Otherwise pull and hold paddle shifter ① or ②.

① If **[D] AUTO** has been selected, briefly pulling paddle shifter ② again reactivates **[D] +**.

The driver's display shows the currently selected recuperation level next to the transmission position display.

ECO Assist

ECO Assist function

ECO Assist is only an aid. It is not a substitute for you paying attention to your surroundings and does not relieve you of your responsibility pertaining to road traffic law. The driver is responsible for

keeping a safe distance from the vehicle in front, for vehicle speed and for braking in good time.

⚠ WARNING Risk of accident if ECO Assist does not provide sufficient deceleration

ECO Assist only brakes your vehicle when you take your foot off the gas pedal. If vehicles are detected late, e.g. after tight curves, or if you do not react immediately to the ECO Assist display, the deceleration may not be sufficient.

- ▶ React promptly to the ECO Assist recommendation and take your foot off the gas pedal.
- ▶ Adjust your speed to the driving conditions and maintain a suitable distance from the vehicle in front.
- ▶ Brake the vehicle yourself and/or take evasive action.

ECO Assist is active only in **[D] AUTO** (→ page 191).

Depending on the vehicle's equipment, ECO Assist analyzes data for the vehicle's expected route. This allows the system to optimally adjust

the driving style for the route ahead, use minimal energy and recuperate as much as possible. If the system has detected an event ahead or a vehicle in front and the vehicle is approaching the event, ECO Assist will calculate an optimized speed profile based on the distance, speed and available route information.

If you release the accelerator pedal in this case, intelligent recuperation will start in overrun mode. If ECO Assist has detected a vehicle traveling in front or a stationary vehicle ahead, it can brake your vehicle to a standstill. This may be the case, for example, at the end of a traffic jam or if the detected vehicle ahead stops in front of you.

If the deceleration provided by ECO Assist is not sufficient, you must also brake with the service brake. This is especially the case if, for example, you pull away again in slow-moving traffic and the distance to the vehicle in front is very short.

Depending on the vehicle equipment and at low speeds, e.g. in a parking garage or on play streets, no adjustment will be made for stationary vehicles and therefore there will be no display.

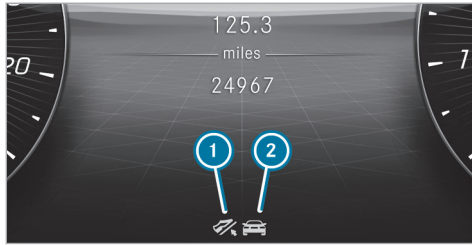

- ① "Foot off the accelerator" recommendation
- ② Route event ahead
- ⓘ ECO Assist can also be shown on the head-up display.

If a route event that requires an adjustment of your driving style is detected ahead, corresponding symbol ② and the  symbol (gray) will be displayed.





If you release the accelerator pedal, the  symbol will turn green and recuperation in overrun mode will be initiated. If the deceleration is not sufficient, also apply the service brake.

If ECO Assist intervenes for a route event ahead and you then press the accelerator pedal, ECO Assist's control is ended. This does not apply in the case of a vehicle traveling in front.

The ECO Assist display is hidden again in the following cases:

- You do not react to the ECO Assist recommendation for a long time.
- You press the accelerator while ECO Assist is intervening for a route event ahead. This does not apply in the case of a vehicle traveling in front.
- ECO Assist cannot identify any further recommendations from the route ahead.

In addition to a vehicle in front , ECO Assist can detect the following route events ② depending on the vehicle's equipment:

-  Traffic circle
-  S-curve
-  Sharp curve
-  T-intersection
-  Downhill gradient

 Speed limit

ECO Assist can also react to other intersections or turns if you activate the turn signal indicator in good time.

- ⓘ On roads with an obligation to drive in a lane as far to the right as possible, vehicles driving in the lane to your left will also be recognized as vehicles ahead of you.

To enable ECO Assist to react to future route events, the equipment-dependent speed adaptation functions of Active Distance Assist must be active (→ page 243).

System limits

If the calculated route is adhered to when route guidance is active, ECO Assist will operate with greater accuracy. The basic function is also available without active route guidance. Not all information and traffic situations can be foreseen. The quality depends on the map data.

- ⓘ ECO Assist will be available after driving off, as soon as the sensor check is completed.

The system may be impaired or may not function in the following situations:

- If there is poor visibility, e.g. due to insufficient illumination of the road, highly variable shade conditions, rain, snow, fog or heavy spray.
- If there is glare, e.g. from oncoming traffic, direct sunlight or reflections.
- If the windshield is dirty in the vicinity of the multifunction camera.
- If the multifunction camera is fogged up, damaged or obscured.
- If road signs are hard to detect, e.g. due to dirt, snow or insufficient lighting, or because they are obscured.
- If the information in the navigation system's digital map is incorrect or out of date.
- If signs are ambiguous, e.g. road signs in roadworks or in adjacent lanes.
- If the radar sensors are dirty or obscured.
- When you drive on roads with steep uphill or downhill gradients.
- If there are narrow vehicles in front, such as bicycles or motorcycles.

■ Activating and deactivating ECO Assist

Multimedia system:

→  » Settings » Assistance
» Driving

- ▶ Activate or deactivate the function.

Function of the haptic accelerator pedal

The haptic accelerator pedal features an additional pressure point to help you drive as efficiently as possible in drive program .

Range maximization

■ Range maximization function

The range maximization function enables a maximum range gain. To achieve this, the function partially or completely switches off convenience systems that are not relevant to driving and activates efficiency-enhancing driving functions.

The range maximization function controls the restrictions of the following function groups:

- **Climate control**

- Restricting climate control functions and deactivating front windshield, rear window and mirror heating



- **Interior**

- Switching off ambient lighting, displays and certain charging functions

- **Seating comfort**

- Deactivating the steering wheel heater, seat heating and ventilation and deactivating the massage function

- **ECO drive functions**

- Changing to the  drive program, activating ECO Assist and the  **AUTO** recuperation level

If necessary, you can deactivate the restrictions of individual function groups again. This will reduce the maximum range gain by the value specified for the function group.

If you switch on a deactivated function while range maximization is activated, all restrictions of the corresponding function group will be removed and the maximum range gain will be reduced accordingly. For example, if you switch on the

seat heating again, all restrictions of the "Seating comfort" function group will be deactivated.

This does not apply to the "ECO driving functions" group, as the range gain in this case depends mainly on your personal driving style. The activated ECO driving functions help you to drive in an energy-efficient manner. The specified range gain for the ECO drive functions can be achieved only if you observe the driving instructions and recommendations displayed and drive without kickdown.

■ Activating/deactivating range maximization

Multimedia system:

→  ► Settings ► EQ ► Range

- ▶ Activate or deactivate **Maximum Range**. All function groups concerned will be activated or deactivated.

or

- ▶ Individually activate or deactivate the individual subsystems of the four function groups **Climate Control**, **Interior**, **Seat Comfort** and **ECO Driving Functions**.

DYNAMIC SELECT

Function of DYNAMIC SELECT

! NOTE Mercedes-AMG vehicles

- ▶ Observe the notes in the Supplement. You could otherwise fail to recognize dangers.

DYNAMIC SELECT allows a drive program to be selected quickly according to the current driving conditions or the desired vehicle characteristics (→ page 196).

Depending on the drive program selected, the following vehicle characteristics will change:

- Drive
- **Vehicles with AIRMATIC:** suspension (→ page 270)
 - Suspension and damping
 - Vehicle level (speed-dependent)
- Steering
- ESP®

- Sound of the drive system in the vehicle interior
- Point of resistance on the haptic accelerator pedal
- ① In drive program **[E]**, an additional pressure point is activated in the haptic accelerator pedal.
 - First point of resistance: at approx. 60% pedal travel (only in **[E]**)
 - Second point of resistance: transition to kickdown (always available)

Available drive programs

 (Individual)

- The following vehicle characteristics are individually adjustable:
 - Drive
 - Suspension
 - Steering
 - ESP®
 - Sound of the drive system in the vehicle interior

S (Sport)

- Sporty and dynamic driving characteristics
- Suitable only for good road conditions, a dry surface and a clear stretch of road

C (Comfort)

- Comfortable driving style
- Recommended for all road conditions
- Best balance between efficiency and performance for all driving situations

E (Eco)

- Economical setting of vehicle functions
- Recommended for all road conditions
- Additional first point of resistance in the haptic accelerator pedal indicates an efficient, economical driving style

 (Off-road)



- For driving on easily and moderately negotiable terrain, e.g. on dirt tracks, loose surfaces, gravel or sand, as well on uneven terrain, where there are no firm road surfaces

- Intervenes later if there is overseering or under steering, thus improving traction
- Not suitable for use on public roads
- Can be selected up to a maximum of 62 mph (100 km/h)
- **Vehicles with AIRMATIC:**
 - Raises the vehicle to off-road level +1
 - From 43 mph (70 km/h): lowers the vehicle to normal level
 - below 31 mph (50 km/h): raises the vehicle to off-road level +1 again
- from 68 mph (110 km/h): switch to **C**

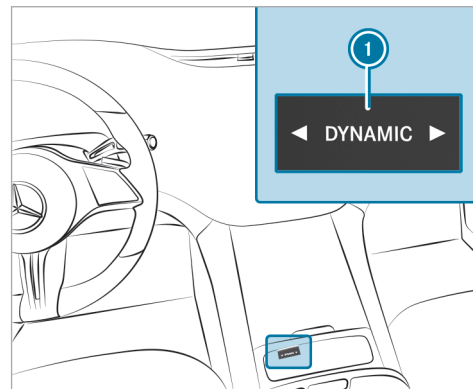
The ESP® settings in the drive programs **E** and **C** are designed for stability. Therefore, choose one of these drive programs especially when transporting roof loads, in trailer operation and when the vehicle is fully loaded or fully occupied.

Selecting the drive program

- ▶ Press DYNAMIC SELECT button ① on the left or right.
The drive program selected will appear on the driver's display.

- i** In drive program , some driving systems are restricted in their function or not available. When selecting drive program , a confirmation prompt therefore appears on the central display before the drive program is activated.

Configuring DYNAMIC SELECT in the MMS

Multimedia system:

- ➔  ➔ Settings ➔ Vehicle
- ➔ DYNAMIC SELECT

Setting drive program I

- ▶ Select  Individual.
- ▶ Select and set a category.

Switching the reset display on/off

- ▶ Activate or deactivate Request at Start.
- i** This function must be activated for each user profile separately. Only when this function is activated will the drive program and ECO start/stop setting for the previous journey be saved for the respective user profile.

Function on: the next time the vehicle is started a prompt appears asking whether the last active drive program should be restored. If the ECO start/stop function was deactivated, an additional prompt appears asking if the function should remain deactivated.

- i** The prompt only appears if the previously active settings deviate from the standard settings.

Function off: the next time the vehicle is started the  drive program is set automatically. The ECO start/stop function is activated automatically.

Configuring DYNAMIC SELECT in the MMS (plug-in hybrid and electric vehicles)

Multimedia system:

- ➔  ➔ Settings ➔ Vehicle
- ➔ DYNAMIC SELECT

Setting drive program I

- ▶ Select  Individual.
- ▶ Select and set a category.

Switching the reset display on/off

- ▶ Activate or deactivate Request at Start.
- i** This function must be activated for each user profile separately. The drive program for the respective user profile of the last driver is only stored if this function is activated.

Function on: the next time the vehicle is started a prompt appears asking whether the last active drive program should be restored.

- i** The prompt only appears if the previously active settings deviate from the standard settings.

Function off: the next time the vehicle is started the  drive program is set automatically.

Displaying vehicle data

Multimedia system:

- ➔  ➔ Info
- ▶ Select Vehicle.
- ▶ The vehicle data is displayed.

Calling up the fuel consumption indicator

Multimedia system:



▶ Select **Consumption**.

The current and average fuel consumption will be displayed.

Transmission

DIRECT SELECT lever

Function of the DIRECT SELECT lever

⚠ WARNING Risk of accident and injury due to children left unattended in the vehicle

If you leave children unattended in the vehicle, they could, in particular:

- open doors, thereby endangering other persons or road users.
- get out and be struck by oncoming traffic.
- operate vehicle equipment and become trapped, for example.

In addition, the children could also set the vehicle in motion by, for example:

- releasing the parking brake.
 - changing the gearbox position.
 - starting the vehicle.
- ▶ Never leave children unattended in the vehicle.
- ▶ When leaving the vehicle, always take the key with you and lock the vehicle.
- ▶ Keep the key out of reach of children.

Use the DIRECT SELECT lever to switch the transmission position. The current transmission position will be shown on the driver's display.

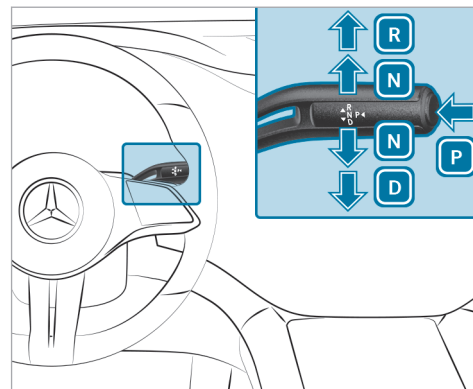

- P** Park position
- R** Reverse gear
- N** Neutral
- D** Drive position

Engaging reverse gear R

▶ Depress the brake pedal and push the DIRECT SELECT lever upwards past the first point of resistance.

Engaging neutral N

- ▶ Depress the brake pedal and push the DIRECT SELECT lever up or down to the first point of resistance, holding it there until transmission position **N** is shown on the driver's display.

Subsequently releasing the brake pedal will allow you to move the vehicle freely, e.g. to push it or tow it away.

If you want the transmission to remain in neutral N even if the vehicle is switched off:

- ▶ Start the vehicle.
 - ▶ Depress the brake pedal and engage neutral **N**.
 - ▶ Release the brake pedal.
 - ▶ Switch off the vehicle.
- i** If you then exit the vehicle leaving the key in the vehicle, the transmission will remain in neutral **N**.

Engaging park position P

i **NOTE** Damage due to engaging park position **P** while the vehicle is rolling

If you shift the transmission into park position **P** while the vehicle is rolling, the transmission may be damaged.

- ▶ If the vehicle is rolling, do not open a door.
- ▶ Only engage park position **P** when the vehicle is stationary.

- ▶ Observe the notes on parking the vehicle (→ page 217).
- ▶ Depress the brake pedal until the vehicle comes to a standstill.
- ▶ When the vehicle is stationary, press button **P**.
When the transmission position display shows **P**, the park position is engaged. If the transmission position display **P** is not shown, apply the parking brake and secure the vehicle to prevent it from rolling away.

- i** Depending on the situation, it may take a short time until **P** is engaged. Therefore, always pay attention to the transmission position display.

Park position **P** will be engaged automatically if one of the following conditions is met:

- You switch the stationary vehicle off in transmission position **D** or **R**.
 - You open the driver's door when the vehicle is stationary in transmission position **D** or **R**.
 - When the vehicle is rolling, you switch it off in transmission position **D** or **R** and bring it to a standstill.
 - When the vehicle is rolling, you shift to transmission position **N**, bring the vehicle to a standstill and open the driver's door when the vehicle is stationary.
 - Engaging park position **P** automatically is required by the vehicle.
- i** To maneuver with an open driver's door, open the driver's door while the vehicle is stationary and engage transmission position **D** or **R** again.

Engaging drive position D

- ▶ Depress the brake pedal and push the DIRECT SELECT lever down past the first point of resistance.

Function of 4MATIC

The flexible all-wheel distribution of the 4MATIC means the drive is always ideally distributed between both axles. Depending on the situation, only the front axle or only the rear axle can be driven, or the drive can be distributed continuously between both axles.

This means that recuperation can be used even more effectively and the range of the vehicle can be increased (→ page 190).

Together with ESP® and 4ETS, 4MATIC improves the traction of your vehicle whenever a driven wheel spins due to insufficient traction.

If you fail to adapt your driving style, 4MATIC can neither reduce the risk of an accident nor override the laws of physics. It cannot take into account road, weather or traffic conditions. 4MATIC is only an aid. You are responsible especially for main-

taining a safe distance from the vehicle in front, for vehicle speed, for braking in good time and for staying in lane.

- ⓘ In wintry road conditions, the maximum effect of the flexible all-wheel distribution can be achieved only if you use winter tires (M+S tires), with snow chains if necessary.

Charge the high-voltage battery

Notes on charging the high-voltage battery

- ! **NOTE** High-voltage battery damage due to leaving the vehicle idle for lengthy periods of time

Lithium-ion batteries experience a natural self-discharge.

Exhaustive discharging can therefore occur if the vehicle is idle for several months. This can damage the high-voltage battery.

- ▶ To avoid damage, please observe the following recommendations when handling the high-voltage battery.

- ! **NOTE** Accelerated aging of the high-voltage battery due to not observing the following recommendations

As a result of its basic characteristics, the storage capacity of and the amount of energy available from the high-voltage battery decreases over the course of its life. Due to this, both the maximum electrical range that can be achieved by the vehicle and its maximum electrical output can be impaired.

The following factors could accelerate the aging of the high-voltage battery:

- Frequent full charging (condition of charge 100%) of the high-voltage battery, in particular without subsequently driving directly afterwards
- Frequent rapid charging with direct current (mode 4)
- Leaving the vehicle idle for lengthy periods at high ambient temperatures
- ▶ To avoid accelerated aging, please observe the following recommendations when handling the high-voltage battery.

Recommendations for handling the high-voltage battery:

- Every six months, when the outside temperature is above 50°F (10°C), park the vehicle overnight with a state of charge below 20%.
- Charge the high-voltage battery with direct current (mode 4) only if necessary.
- Charge the high-voltage battery to a state of charge of 80% on average. Beyond a state of charge of 80%, charging time will be prolonged considerably.
- If leaving the vehicle idle for lengthy periods, park up the vehicle with a high-voltage battery state of charge between 30% and 50%. Do not keep the high-voltage battery continuously connected to power supply equipment.
- If leaving the vehicle idle for lengthy periods of time avoid high ambient temperatures if possible.
- Check the high-voltage battery's state of charge every six weeks (→ page 215).
- Charge the high-voltage battery if the state of charge is below 20%.

- Do not disconnect the 12 V battery even if the vehicle is left idle for a lengthy period. Otherwise, the condition of the vehicle's high-voltage battery cannot be monitored.

You can contribute to reducing the vehicle's energy consumption in the following ways:

- An anticipatory driving style (→ page 190)
- Reduced use of electrical consumers
- Having the vehicle regularly maintained

The charging time of the high-voltage battery may change over the course of its life.

You can charge the high-voltage battery with both alternating current (mode 2 or 3) and direct current (mode 4).

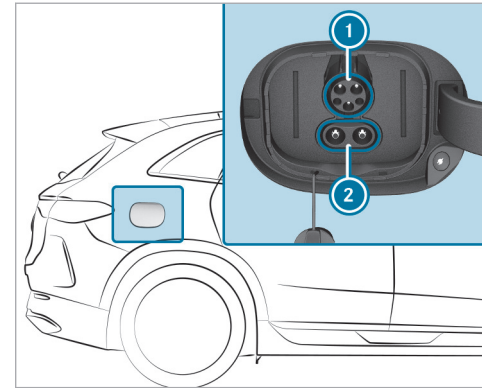

- ① Socket for AC charging
- ② Socket extension for DC charging
- i When you use a CCS (Combined Charging System) charging cable to charge with direct current, both areas of the vehicle socket will be covered by the charging cable connector.

Charging options for the high-voltage battery (mode 2, 3 or 4):

- Charging through recuperation while the vehicle is in motion
- AC charging when stationary:
 - at a mains socket (mode 2)
 - at a wallbox or charging station (mode 3)
- DC charging when stationary:
 - at a rapid charging station (mode 4)

Depending on the country-specific vehicle equipment and your vehicle's charging cable, single-phase AC charging is also possible.

Observe the different grid requirements of your current location when charging. Use only charging cables that conform to the grid requirements. Consult a qualified electrician or your local grid operator if you have any questions.

It is recommended that you charge the high-voltage battery at a wallbox or charging station due to the improved charging performance and better charging efficiency offered.

System limits

The power output of the high-voltage battery may be impaired by the following:

- High or low outside temperatures
- Electrical auxiliary consumers in the vehicle being switched on, e.g. the air conditioning system being operated
- Extended periods without charging

The charging time of the high-voltage battery may be increased by the following:

- High or low outside temperatures
- Extended periods without charging
- The maximum available charge current of the charging facility
- The settings of the charging process in the multimedia system (→ page 216)

Stowing the charging cable

Always stow the vehicle's charging cable in the charging cable bag provided and secure the charging cable bag in the trunk or cargo compartment with the included retaining strap. Otherwise,

the charging cable bag with the charging cable is not sufficiently secured.



Example: charging cable bag in the trunk /cargo compartment

As delivered, charging cable bag ① with retaining strap ② is located in the trunk or cargo compartment. To secure the charging cable bag, the retaining strap must be attached to a cargo tie-

down ring ③. Do not use bag hooks to attach the retaining strap.

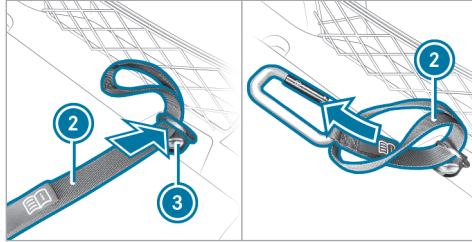

- ▶ Feed the loop end of retaining strap ② through cargo tie-down ring ③ into the trunk or cargo compartment.
- ▶ Feed the end with the snap hook through the loop of retaining strap ②.



- ▶ Tighten retaining strap ② so that the knot around cargo tie-down ring ③ is tight and secure.
- ▶ Hook the snap hook of retaining strap ② in a cargo tie-down ring of charging cable bag ①.

Notes on charging the high-voltage battery at the mains socket (mode 2)

⚠ DANGER Risk of fatal injury from incorrectly installed component parts

Connecting the charging cable to a mains socket using incorrectly installed component parts could cause a fire or an electric shock, for example.

- ▶ Only connect the charging cable to a mains socket that:
 - has been properly installed and
 - has been inspected by a qualified electrician
- ▶ For safety reasons, only use the charging cable supplied with the vehicle or an original Mercedes-Benz charging cable.
- ▶ Purchase these parts at an authorized Mercedes-Benz Center and obtain advice there.

Mercedes-Benz thoroughly tests these original charging cables for their suitability for high-voltage charging of your vehicle.

- ▶ Never use a damaged charging cable.
- ▶ Do not use:
 - extension cables
 - extension reels
 - multiple sockets
- ▶ Never use socket adapters to connect the charging cable to the mains socket. The only exception being if the adapter has been tested and approved by the manufacturer for charging the high-voltage battery of an electric vehicle.
- ▶ Observe the safety notes in the operating instructions for the socket adapter.

Only the following charging cables may be used:

- the charging cable supplied with the vehicle.
- a charging cable that has been approved for the vehicle.

The charging process can vary depending on the power supply equipment. The charging times when charging the high-voltage battery at the mains socket are considerably longer than when charging at a wallbox or charging station.

When doing so, always observe the local information.

Do not leave the charging cable controls hanging loose from a mains socket.

Do not lift the controls by the following component parts:

- the charging cable connector
- the mains plug

When charging, protect the charging cable control element from excessive heat such as direct sunlight. Otherwise, the charging process may be canceled.

Notes on charging the high-voltage battery at a wallbox or charging station (mode 3)

⚠ DANGER Risk of fatal injury from incorrectly installed component parts

Connecting the charging cable to the vehicle using incorrectly installed components could cause a fire or an electric shock, for example.

- ▶ Only connect the charging cable to a wallbox if:
 - The wallbox has been properly installed
 - The wallbox has been inspected by a qualified electrician
 - The charging cable is not damaged
- ▶ Do not extend the charging cable.
- ▶ Do not use adapters.
- ▶ Observe the safety notes in the operating instructions for the wallbox.

⚠ DANGER Risk of fatal injuries due to damaged components

If you use a damaged component to connect the vehicle to the charging station, this can result in fire or an electric shock, for example.

- ▶ Perform a visual inspection of the charging station for obvious defects, e.g. damage to the housing or on the charging cable connection.
- ▶ At charging stations without a pre-installed cable, for safety reasons, only use charging cables that have been tested and approved by the manufacturer for charging the high-voltage battery in an electric vehicle.
- ▶ Do not use a damaged charging cable.
- ▶ Do not use an extension for the charging cable.
- ▶ Do not use an adapter.
- ▶ Always observe the safety information on the charging station.

Most charging stations must be activated before the charging process, e.g. using an RFID card or via Plug & Charge. Observe the on-site operator's instructions for the charging station and the notes on Mercedes me Charge (see the vehicle's Digital Operator's Manual).

The amount of energy dispensed for the charging process, shown by the charging station, may be higher than the amount of energy actually absorbed by the high-voltage battery. This is the result of different levels of charging losses and is described as recharge efficiency. Charging losses occur, for example, due to heat that builds up when the vehicle is charging or from auxiliary consumers that are switched on. Further information on recharge efficiency can be obtained at a qualified specialist workshop.

Notes on charging the high-voltage battery at a rapid charging station (mode 4)

⚠ DANGER Risk of fatal injuries due to damaged components

If you use a damaged component to connect the vehicle to the charging station, this can result in fire or an electric shock, for example.

- ▶ Perform a visual inspection of the charging station for obvious defects, e.g. damage to the housing or on the charging cable connection.
- ▶ At charging stations without a pre-installed cable, for safety reasons, only use charging cables that have been tested and approved by the manufacturer for charging the high-voltage battery in an electric vehicle.
- ▶ Do not use a damaged charging cable.
- ▶ Do not use an extension for the charging cable.
- ▶ Do not use an adapter.

- ▶ Always observe the safety information on the charging station.

⚠ DANGER Risk of fatal injuries when carrying out maintenance work during the charging process

During the charging process, the high-voltage on-board electrical system is under high voltage.

- ▶ Do not perform any maintenance work during the charging process.

Most charging stations must be activated before the charging process, e.g. using an RFID card or via Plug-and-Charge. Observe the on-site operator's instructions for the charging station and the notes on Mercedes me Charge (see the vehicle's Digital Operator's Manual).

The amount of energy dispensed for the charging process, shown by the charging station, may be higher than the amount of energy actually absorbed by the high-voltage battery. This is the result of different levels of charging losses and is described as recharge efficiency. Charging losses occur,

for example, due to heat that builds up when the vehicle is charging or from auxiliary consumers that are switched on. Further information on recharge efficiency can be obtained at a qualified specialist workshop.

Setting the maximum permissible charging current for charging at a mains socket

! **NOTE** Overloading the mains socket due to excessive charging current

If the charging current is too high, the fuse could be tripped or the external mains supply could overheat.

- ▶ Ensure that the external mains supply has been designed to handle the charging current provided.
- ▶ For safety reasons, only use the charging cable supplied with the vehicle or an original Mercedes-Benz charging cable. Mercedes-Benz thoroughly tests these original charging cables for their suitability

ity for high-voltage charging of your vehicle.

- ▶ Purchase these parts at a Mercedes-Benz service center and obtain advice there.
- ▶ Check the maximum charging current using the charging capacity shown on the driver's display.

The charging cable supplied is set to a country-specific maximum charging current value. When charging abroad, the maximum value may exceed the permitted value for that country.

- ▶ Before charging at a mains socket, have the maximum permissible charging current for the relevant mains socket or the building installation checked by a qualified electrician.
- ▶ When charging abroad, observe the country-specific laws.

If you have questions concerning the charging current or if there is a malfunction, please contact a qualified specialist workshop.

Overview of the charging cable operating unit

The charging cable operating unit shows the current status of the charging process.

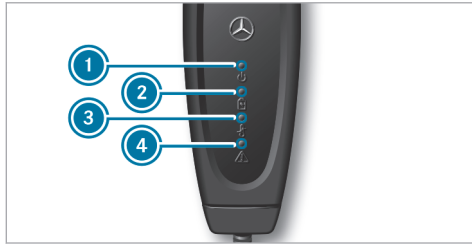

- ① Supply voltage indicator
- ② Charging process indicator
- ③ Temperature monitor indicator
- ④ Safety system indicator

Supply voltage indicator ①

Display	Meaning
Lights up white	The supply voltage is connected.

Charging process indicator ②

Display	Meaning
Flashes green	The high-voltage battery is charging.

Temperature monitor indicator ③

Display	Meaning
Lights up red	The green LED flashes simultaneously: overtemperature – the charging performance is reduced. The green LED does not flash: overtemperature – the charging process is stopped.
Flashes red	Overtemperature at the mains plug – the charging process is stopped.

Safety system indicator ④

Display	Meaning
Flashes red	Charging cable malfunction – cannot carry out the charging process, reset the charging cable operating unit.
Lights up red	White LED is off: power supply malfunction – cannot carry out the charging process, replace the mains socket. White LED is on: vehicle malfunction – cannot carry out the charging process, reset the charging cable operating unit.

When all four displays light up, the charging cable operating unit performs a self-test.

If temperature monitor ③ indicates a malfunction, it may help to protect the charging cable from direct sunlight.

To reset the charging cable operating unit: if safety system ④ indicates a charging cable malfunction or a vehicle malfunction, first reset the charging cable operating unit. To do this, disconnect the charging cable from the vehicle and from the mains socket and wait for approximately five seconds. If the malfunction persists after the charging cable is reconnected, charging at the mains socket is not possible. The charging cable must be replaced or the vehicle plug must be checked at a qualified specialist workshop, depending on the indicator.

Functions of the indicator lamp on the vehicle socket

The socket flap is centrally locked and unlocked together with the vehicle.

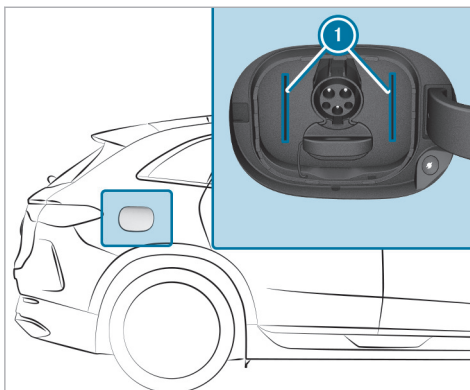

The color and signaling of status display ① have the following meanings:

Locking status

- Lights up white: vehicle socket unlocked; insert or remove charging cable
- Flashes white: disconnection or malfunction during locking or unlocking

Condition of charge

- Lights up blue: charging process completed
- Flashes blue: charging; active energy flow
- Lights up orange: charging paused
- Flashes orange: connection is being established
- Flashes red (for approx. 90 s): malfunction in vehicle; charging not possible

i Vehicles with active ambient lighting: when the charging sequence is activated, the state of charge will also be accompanied by ambient lighting (→ page 155).

Starting the alternating-current charging process (mode 2/3)

⚠ DANGER Risk of death when charging at a damaged socket

The charging process uses high voltage.

If the charging cable, the vehicle socket or the mains socket are damaged, you could receive an electric shock.

- ▶ Only use an undamaged charging cable.
- ▶ Avoid mechanical damage such as crushing, abrading or driving over the cable.
- ▶ Have a damaged vehicle socket replaced at a qualified specialist workshop as soon as possible.
- ▶ Never connect the charging cable to a damaged vehicle socket.

! **NOTE** Damage due to overheating of charging cable and charge port

During the charging process, the charging cable and charge port can heat up within the permissible limits.

The permissible limit values are influenced by the following factors:

- the power supply system and the charging cable are not damaged
- the instructions for handling the charging cable and the control element on the charging cable have been observed

- ▶ If the charging cable or charge port becomes too hot, have the power supply system checked.

! **NOTE** Damaged or dirty vehicle socket when the socket flap is open

- ▶ Always keep the socket cover and the socket flap closed when there is no charging cable connected. This protects the vehicle socket from dirt and damage.
- ▶ Make sure that the socket cover is closed properly before closing the socket flap. This can otherwise result in damage which may prevent the socket flap from being opened again.

! **NOTE** Damage to the vehicle socket or the charging cable connector due to incorrect handling

Do not use excessive force (maximum 67.4 lbf (300 N)) to insert the charging cable connector into the vehicle socket as far as it will go. You may otherwise damage the vehicle socket,

the charging cable connector or their contacts.

- ▶ If you feel there is increased resistance, pull the charging cable connector out of the socket and reinsert it.

Requirements

- The transmission is in position **P**.
- The vehicle is unlocked or the distance between the key and the vehicle does not exceed 3 ft (1 m).
- The vehicle has not been started. The **READY** indicator on the driver's display is off.
- The charging cable is not taut.

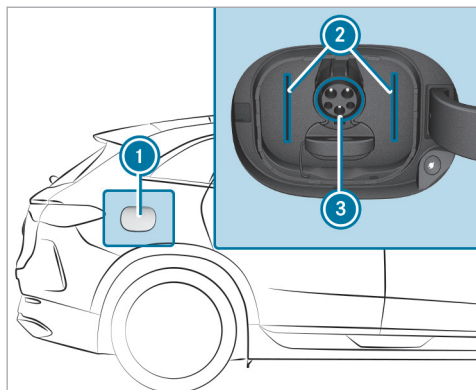

▶ Open socket flap ① via the EQ module of the multimedia system (→ page 320).

or

▶ Press the center rear section of socket flap ①.
Socket flap ① will swing open and status display ② will light up white.

Vehicles with an electrical socket flap: if an obstacle impedes the socket flap while it is opening, the socket flap will close again automatically.

- ① When the vehicle is started (the **READY** indicator is lit up on the driver's display), socket flap ① cannot be opened.
- ① Only upper connection ③ is required for the charging cable connector.

▶ To charge at a mains socket, insert the mains plug into the mains socket of the external power source as far as it will go.

▶ Insert the charging cable connector into vehicle socket connection ③ as far as it will go. If the wallbox/charging station is not equipped with a charging cable, insert the plug of the vehicle's charging cable into the wallbox/charging station socket as far as it will go. Make sure that the charging cable is not taut when inserted.

Status display ② will flash orange and, as soon as the high-voltage battery is charged, blue.

- ① When the charging sequence for the ambient lighting is activated, the ambient lighting will

light up for approximately 30 seconds as with status display ② (→ page 155).

When Sound Experience is activated, different situations, such as the charging cable connector being inserted and removed or the beginning of the charging process, will be accompanied by selected sounds. For information on Sound Experience, please refer to the Digital Operator's Manual.

Vehicles with an electric socket flap: if a charging cable is not connected to the vehicle after the socket flap has been opened, the socket flap will close again automatically.

When the charging cable is connected to the vehicle, the vehicle cannot be started or moved.

At the start of the charging process, the charge level display will be shown on the driver's display with a charging prediction. The charging prediction refers to the time at which the high-voltage battery will be fully charged.

- ① Depending on the temperature, the fan and battery cooling system may audibly switch on during the charging process.

- ⓘ If the vehicle is idle for lengthy periods and connected to the mains supply, the high-voltage battery will be recharged automatically as needed or when electrical consumers are activated (e.g. pre-entry climate control).

Ending the alternating current charging process (mode 2/3)

Requirements

- The distance between the SmartKey and the vehicle does not exceed 3 ft (1 m).

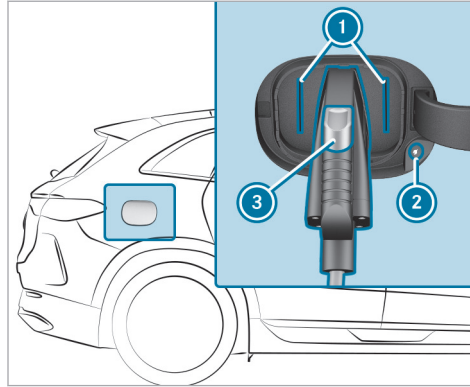

- ▶ Press charging interruption button ②. The charging process is ended. Status display ① lights up white. The vehicle socket is unlocked.
- ▶ Press and hold button ③ on the charging cable connector and remove the charging cable connector from the vehicle socket.
- ⓘ If you cannot remove the charging cable connector, repeat the unlocking procedure. If the

charging cable connector is still locked, contact a qualified specialist workshop.

- ⓘ Status display ① remains lit for some time after the charging cable connector has been removed and then goes out.

- ▶ Close the socket flap. For vehicles with an electric socket flap, observe the following notes on closing the socket flap.
- ▶ Remove the charging cable connector from the mains socket, or from the socket on the wallbox/charging station, and stow the vehicle's charging cable safely in the vehicle (→ page 202).

The electric socket flap closes automatically in the following situations:

- shortly after the charging cable connector has been removed
- after the socket flap has been tapped in the direction to close it
- after transmission position **N**, **D** or **R** has been engaged

Automatic reversing function of the electric socket flap

If an obstacle impedes the electrical socket flap while it is closing, the socket flap will open again automatically.

- ▶ When closing the socket flap, make sure that no body parts or objects are in the closing area.

Starting the direct-current charging process (mode 4)

⚠ DANGER Risk of death when charging at a damaged socket

The charging process uses high voltage.

If the charging cable, the vehicle socket or the mains socket are damaged, you could receive an electric shock.

- ▶ Only use an undamaged charging cable.
- ▶ Avoid mechanical damage such as crushing, abrading or driving over the cable.

- ▶ Have a damaged vehicle socket replaced at a qualified specialist workshop as soon as possible.
- ▶ Never connect the charging cable to a damaged vehicle socket.

! **NOTE** Damage due to overheating of charging cable and charge port

During the charging process, the charging cable and charge port can heat up within the permissible limits.

The permissible limit values are influenced by the following factors:

- the power supply system and the charging cable are not damaged
 - the instructions for handling the charging cable and the control element on the charging cable have been observed
- ▶ If the charging cable or charge port becomes too hot, have the power supply system checked.

! **NOTE** Damaged or dirty vehicle socket when the socket flap is open

- ▶ Always keep the socket cover and the socket flap closed when there is no charging cable connected. This protects the vehicle socket from dirt and damage.
- ▶ Make sure that the socket cover is closed properly before closing the socket flap. This can otherwise result in damage which may prevent the socket flap from being opened again.

! **NOTE** Damage to the vehicle socket or the charging cable connector due to incorrect handling

Do not use excessive force (maximum 67.4 lbf (300 N)) to insert the charging cable connector into the vehicle socket as far as it will go. You may otherwise damage the vehicle socket, the charging cable connector or their contacts.

- ▶ If you feel there is increased resistance, pull the charging cable connector out of the socket and reinsert it.

Requirements

- The transmission is in position **P**.
- The vehicle is unlocked or the distance between the key and the vehicle does not exceed 3 ft (1 m).
- The vehicle has not been started. The **READY** indicator on the driver's display is off.
- The charging cable is not taut.

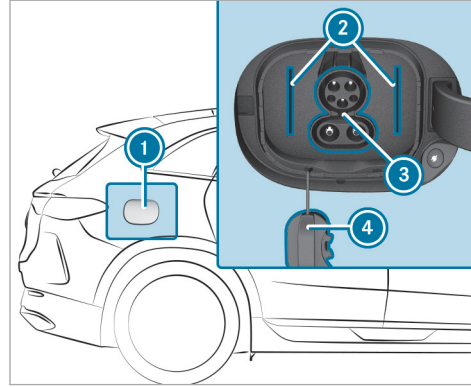

- ▶ Open socket flap ① via the EQ module of the multimedia system (→ page 320).

or

- ▶ Press the center rear section of socket flap ①. Socket flap ① will swing open and status display ② will light up white.

Vehicles with an electrical socket flap: if an obstacle impedes the socket flap while it is opening, the socket flap will close again automatically.

- ① When the vehicle is started (the **READY** indicator is lit up on the driver's display), socket flap ① cannot be opened.
- ▶ Remove socket cover ④ from the lower connection of vehicle socket ③.
- ① The CCS charging cable connector requires both vehicle socket connections ③.
- ▶ Insert the charging cable connector into vehicle socket ③ as far as it will go. Make sure that the charging cable is not taut when inserted. Status display ② will flash orange and, as soon as the high-voltage battery is charged, blue.
- ① When the charging sequence for the ambient lighting is activated, the ambient lighting will light up for approximately 30 seconds as with status display ② (→ page 155).

When Sound Experience is activated, different situations, such as the charging cable connector being inserted and removed or the beginning of the charging process, will be accompanied by selected sounds. For information on Sound Experience, please refer to the Digital Operator's Manual.

Vehicles with an electric socket flap: if a charging cable is not connected to the vehicle after the socket flap has been opened, the socket flap will close again automatically.

When the charging cable is connected to the vehicle, the vehicle cannot be started or moved.

At the start of the charging process, the charge level display will be shown on the driver's display with a charging prediction. The charging prediction refers to the time at which the high-voltage battery will be fully charged.

- ① Depending on the temperature, the fan and battery cooling system may audibly switch on during the charging process.
- ① If the vehicle is idle for lengthy periods and connected to the mains supply, the high-voltage battery will be recharged automatically as

needed or when electrical consumers are activated (e.g. pre-entry climate control).

Ending the direct current charging process (mode 4)

Requirements:

- The distance between the key and the vehicle does not exceed 3 ft (1 m).

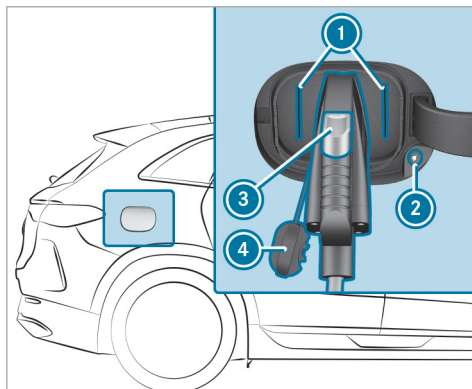

- ▶ Press charging interruption button ②. The charging process is ended. Status display ① lights up white. The vehicle socket is unlocked.
- ▶ Press and hold button ③ on the charging cable connector and remove the charging cable connector from the vehicle socket.
- ① If you cannot remove the charging cable connector, unlock the vehicle and repeat the procedure. If the charging cable connector is still locked, contact a qualified specialist workshop.
- ① Status display ① indicator lamp remains lit for some time after the charging cable connector has been removed and then goes out.
- ▶ Insert socket cover ④ into the lower vehicle socket connection.
- ▶ Close the socket flap. For vehicles with an electric socket flap, observe the following notes on closing the socket flap.

The electric socket flap closes automatically in the following situations:

- shortly after the charging cable connector has been removed
- after the socket flap has been tapped in the direction to close it
- after transmission position **N**, **D** or **R** has been engaged

Automatic backing up function of the electric socket flap

If an obstacle impedes the electrical socket flap while it is closing, the socket flap will open again automatically. The automatic backing up function is only an aid and is not a substitute for your attentiveness.

- ▶ When closing the socket flap, make sure that no body parts or objects are in the closing area.

Function of the charge level display in the driver's display

- ⓘ The data shown in the illustration is example data.

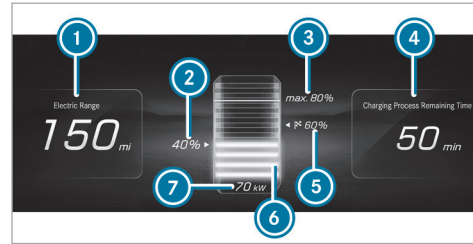

- 1 Range at current charge level
- 2 Current state of charge of the high-voltage battery
- 3 Maximum state of charge (depending on the setting)
- 4 Time remaining until completely charged (until the selected maximum charge level is reached)
- 5 Charge level recommended by Range Assistant to reach the next destination
- 6 Dynamic charge level display
- 7 Current charging capacity

- ⓘ Specified remaining range 1 may vary due to different factors, e.g. driving style or topography.

When the vehicle is connected to the mains supply and is switched off, the driver's display shows the charge level display for approximately two minutes.

- ⓘ The value of current charging capacity 7 can differ from the display on the charging station. At a charging capacity of 10 kW or higher, the value in the charge level display is rounded off and shown without a decimal place.

The value in 4 varies depending on the setting of the charging process. It displays the charging prediction, e.g. the time at which the selected charge level will be reached or the charge level at the pre-selected departure time.

Configuring the charging settings

Multimedia system:



Setting the charging program

- ▶ Select **Home**, **Work** or **Standard**.

Opening and closing the socket flap using the MMS

- ▶ Press **Open socket flap** to open the socket flap.
- ▶ The charging process can be interrupted using **Stop Charging**. The charging process will be ended and the charging cable released.
- ▶ Press **Close socket flap** to close the socket flap. The socket flap will also close automatically when the transmission is shifted out of position **P**. The socket flap will also close automatically after one minute if it has been opened but no plug has been inserted, and ten to fifteen seconds after the plug has been removed.

- ⓘ Further notes on charging with alternating current: (→ page 208) or direct current: (→ page 212).

Releasing the charging cable (mode 3 or 4)

- ⓘ When the function is active, the charging cable will be released when the maximum state of charge is reached.

- ▶ Select **Home** or **Work**.
- ▶ Activate or deactivate **Unlock Charging Cable**.

Activating or deactivating location-based charging

- ▶ Select **Charge at home** or **Charge at work**.
- ▶ Activate or deactivate **Select Based on Location**.

When the function is activated, the vehicle's current position will be saved as one of the selected options. When the address is reached again, the charging program will automatically be switched over as soon as parking position **P** is engaged.

Activating and deactivating ECO charging

- ▶ Activate or deactivate the function.

The **ECO charging** function limits the charging voltage at charging stations to conserve the vehicle's battery.

Setting the departure time

The set departure times are used for the vehicle's pre-entry climate control and for predictions regarding the approximate state of charge and range at the time selected. The charging process will always start immediately, irrespective of the next departure time.

- ▶ Select **Departure Time**.

The following charging times can be selected:

- individual charging times
- a **Week Profile**

Setting an individual departure time

- ▶ Select **Add New Time** and set a new departure time.

or

- ▶ Select  and adapt an existing departure time.

Setting the repeat days

- ▶ Select **Add New Time** and set a new departure time.
- ▶ Mark the relevant weekdays to which the departure time will apply and confirm with **OK**.



or

- ▶ Select  and edit existing repeat days.

Setting a break in the charging process

Up to four breaks in the charging process can be set during which the vehicle will not be charged even if it is connected to a charging station.

- ▶ Select **Charging Pauses**.
- ▶ Select **Add New Time** and then set and save the times for the beginning and end of the break.
- ▶ Activate or deactivate the charging breaks that have been set.

Set charging breaks can be edited with the  button or deleted with the  button.

Parking

Parking the vehicle

⚠ WARNING Risk of accident and injury caused by an insufficiently secured vehicle rolling away

If the vehicle is not securely parked sufficiently, it can roll away in an uncontrolled way even at a slight downhill gradient.

- ▶ On uphill or downhill gradients, turn the front wheels so that the vehicle rolls towards the curb if it starts moving.
- ▶ Apply the parking brake.
- ▶ Switch the transmission to position **P**.

⚠ WARNING Risk of accident and injury due to children left unattended in the vehicle

If you leave children unattended in the vehicle, they could, in particular:

- open doors, thereby endangering other persons or road users.

- get out and be struck by oncoming traffic.
- operate vehicle equipment and become trapped, for example.

In addition, the children could also set the vehicle in motion by, for example:

- releasing the parking brake.
 - changing the gearbox position.
 - starting the vehicle.
- ▶ Never leave children unattended in the vehicle.
 - ▶ When leaving the vehicle, always take the key with you and lock the vehicle.
 - ▶ Keep the key out of reach of children.

This also applies to the Digital Vehicle Key.

! NOTE Damage to the vehicle due to it rolling away

- ▶ Always secure the vehicle against rolling away.

NOTE Damage caused by vehicle being lowered

Vehicles AIRMATIC: The vehicle can be lowered due to differences in temperature or extended non-operational times. This can cause damage to parts of the body.

▶ When stopping the vehicle and when driving off, make sure that there are no obstacles such as curbs under or in the immediate vicinity of the body.

- i** If you park the vehicle for a long period, observe the following notes:
- Make sure the high-voltage battery has a sufficient state of charge, especially at very low outside temperatures. That way, you can avoid any problems when the vehicle is subsequently started.
 - If possible, avoid parking spaces in direct sunlight.

Observe the notes on charging the high-voltage battery (→ page 200).

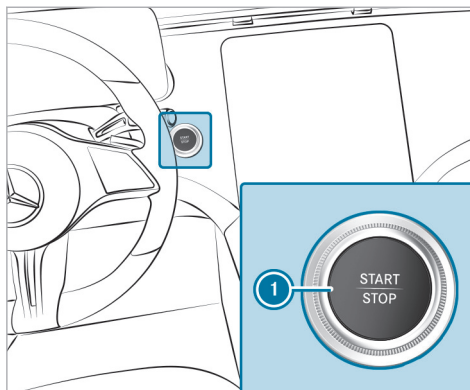

Vehicles with central display

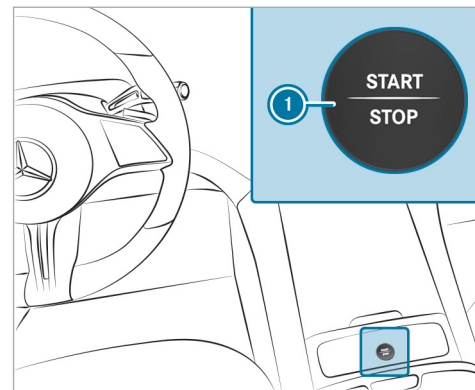

Vehicles with MBUX Hyperscreen

- ▶ Bring the vehicle to a standstill by depressing the brake pedal.
- ▶ On uphill or downhill gradients, turn the front wheels so that the vehicle rolls towards the curb if it starts moving.
- ▶ Apply the electric parking brake.

- ▶ Engage transmission position **P** in a stationary vehicle with the brake pedal depressed (→ page 199).
 - ▶ Switch off the vehicle by pressing button ❶.
 - ▶ Release the service brake slowly.
 - ▶ Get out of the vehicle and lock it.
- ❶ When you park the vehicle, you can still operate the side windows and the panoramic sliding sunroof for approximately four minutes if the driver's door is closed.

Garage door opener

▶ Programming buttons for the garage door opener

⚠ WARNING Risk of injury by becoming trapped when opening and closing a garage door

When you operate or program a garage door with an integrated garage door opener, persons can become trapped or struck by the garage door if they stand within its range of movement.

- ▶ Always make sure that nobody is within the range of the garage door's movement.

Only operate the following doors using the garage door opener:

- Doors with a safety stop and reversing function
- Doors which conform to the current U.S. safety standards

Before programming the garage door opener, park the vehicle outside the garage. Make sure that the vehicle is switched on but not started.

Requirements

- The vehicle has been parked outside the garage or outside the range of movement of the door.
 - The vehicle is switched on.
 - The vehicle has not been started.
- ❶ The garage door opener function is always available when the vehicle is switched on.

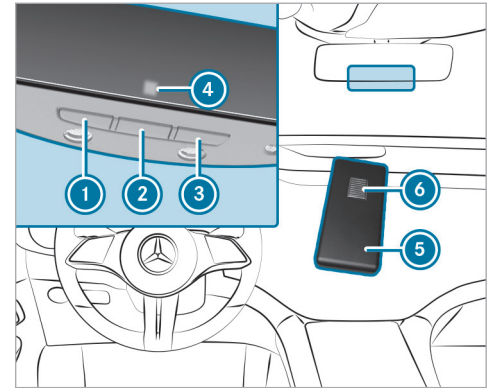

- ▶ Check if the transmitter frequency of the remote control has the frequency range of 280 to 868 MHz.

Radio equipment approval number:

- NZLMUAHL5 (USA)
- 4112A-MUAHL5 (Canada)

▶ Press and hold button ①, ② or ③ that you wish to program.
Indicator lamp ④ flashes yellow.

① It can take up to 20 seconds before the indicator lamp flashes yellow.

▶ Release the previously pressed button.
Indicator lamp ④ continues to flash yellow.

▶ Point remote control ⑤ from a distance of 0.4 in (1 cm) to 3 in (8 cm) towards button ①, ② or ③.

▶ Press and hold button ⑥ of remote control ⑤ until one of the following signals appears:

- Indicator lamp ④ lights up green continuously. Programming is complete.
- Indicator lamp ④ flashes green. Programming was successful. Additionally, synchronization of the rolling code with the door system must be carried out.

▶ If indicator lamp ④ does not light up or flash green: repeat the procedure.

▶ Release all of the buttons.

① The remote control for the door drive is not included in the scope of delivery of the garage door opener.

■ Synchronizing the rolling code

Requirements

- The door system uses a rolling code.
- The vehicle must be within range of the garage or door drive.
- The vehicle as well as persons and objects are located outside the range of movement of the door.

▶ Press the programming button on the door drive unit.
Initiate the next step within approximately 30 seconds.

▶ Press previously programmed button ①, ② or ③ repeatedly until the door closes.
When the door closes, programming is completed.

① Please also read the operating instructions for the door drive.

■ Troubleshooting when programming the remote control

▶ Check if the transmitter frequency of remote control ⑤ is supported.

▶ Replace the batteries in remote control ⑤.

▶ Hold remote control ⑤ at various angles from a distance of 0.4 in (1 cm) to 3 in (8 cm) in front of the inside rearview mirror. You should test every position for at least 25 seconds before trying another position.

▶ Hold remote control ⑤ at the same angles at various distances in front of the inside rearview mirror. You should test every position for at least 25 seconds before trying another position.

▶ On remote controls that transmit only for a limited period, press button ⑥ on remote control ⑤ again before transmission ends.

▶ Angle the antenna line of the garage door opener unit towards the remote control.

- ❗ It is possible that older garage doors cannot be operated using the remote control in the inside rearview mirror even after you have successfully performed the measures described above. If this is the case, contact the HomeLink® Hotline.
- ❗ Support and additional information on programming:
 - on the toll free HomeLink® Hotline on 1-800-355-3515
 - online at the <https://www.homelink.com/mercedes>

■ Opening or closing a garage door

Requirements

- The corresponding button is programmed to operate the door.
- ▶ Press and hold buttons ❶, ❷ or ❸ until the door opens or closes.
 - ▶ If indicator lamp ❹ flashes yellow after approx. 20 seconds: Press the previously pressed button again and keep it pressed until the door opens or closes.

■ Clearing the garage door opener memory

- ▶ Press and hold buttons ❶ and ❷. Indicator lamp ❹ lights up yellow.
- ▶ If indicator lamp ❹ flashes green: release buttons ❶ and ❷. The entire memory has been deleted.

Electric parking brake

■ Function of the electric parking brake (applying automatically)

⚠ WARNING Risk of accident and injury due to children left unattended in the vehicle

If you leave children unattended in the vehicle, they could, in particular:

- open doors, thereby endangering other persons or road users.
- get out and be struck by oncoming traffic.
- operate vehicle equipment and become trapped, for example.

In addition, the children could also set the vehicle in motion by, for example:

- releasing the parking brake.
 - changing the gearbox position.
 - starting the vehicle.
- ▶ Never leave children unattended in the vehicle.
 - ▶ When leaving the vehicle, always take the key with you and lock the vehicle.
 - ▶ Keep the key out of reach of children.

This also applies to the Digital Vehicle Key.

The electric parking brake is applied if the transmission is in position **P** and one of the following conditions is fulfilled:

- The vehicle is switched off.
 - The seat belt tongue is not inserted in the seat belt buckle of the driver's seat and the driver's door is opened.
- ❗ To prevent application: pull the handle of the electric parking brake (→ page 222).

222 Driving and parking

In the following situations, the electric parking brake is also applied:

- The HOLD function is keeping the vehicle stationary.
- Active Parking Assist is keeping the vehicle stationary.
- Active Distance Assist DISTRONIC is bringing the vehicle to a standstill.
- **In addition, one of the following conditions must be fulfilled:**
 - The vehicle is switched off.
 - The seat belt tongue is not inserted in the seat belt buckle of the driver's seat and the driver's door is opened.
 - There is a system malfunction.
 - The power supply is insufficient.
 - The vehicle is stationary for a lengthy period.

When the electric parking brake is applied, the red **PARK** (USA) or **(P)** (Canada) indicator lamp lights up in the driver's display.

Function of the electric parking brake (releasing automatically)

The electric parking brake is released when the following conditions are fulfilled:

- The driver's door is closed.
- The vehicle has been started.
- The transmission is in position **D** or **R** and you depress the accelerator pedal or you shift from transmission position **P** to **D** or **R** when on level ground.
- If the transmission is in position **R**, the tail-gate must be closed.
- The seat belt tongue is inserted into the seat belt buckle of the driver's seat.

If the seat belt tongue is not inserted into the seat belt buckle of the driver's seat, one of the following conditions must be fulfilled:

- You shift from transmission position **P**.
- or
- You have previously driven at speeds greater than 2 mph (3 km/h).

When the electric parking brake is released, the red **PARK** (USA) or **(P)** (Canada) indicator lamp in the driver's display goes out.

Applying/releasing the electric parking brake manually

Applying

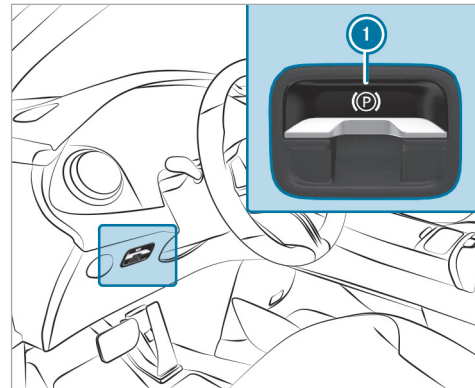

- ▶ Push handle ①.
The red **PARK** (USA) or **(P)** (Canada) indicator lamp lights up in the driver's display.
- ① The electric parking brake is only securely applied if the red **PARK** (USA) or **(P)** (Canada) indicator lamp is lit continuously.

Releasing

- ▶ Switch on the vehicle.
- ▶ Pull handle ①.
The red **PARK** (USA) or **(P)** (Canada) indicator lamp in the driver's display goes out.

Emergency braking

- ▶ Press and hold handle ①.
As long as the vehicle is in motion, the **Release Parking Brake** message is displayed and the red **PARK** (USA) or **(P)** (Canada) indicator lamp flashes.
- When the vehicle has been braked to a standstill, the electric parking brake is applied. The red **PARK** (USA) or **(P)** (Canada) indicator lamp lights up in the driver's display.

Information on collision detection on a parked vehicle

If a collision is detected on the locked vehicle when towing protection is switched on and collision detection is switched on, you will receive a message in the multimedia system when the vehicle is switched on.

You will receive information about the following points:

- The area of the vehicle that may have been damaged.
- The force of the impact.

The following situation can lead to inadvertent activation:

- The parked vehicle is moved, foreexample, in a two-storey garage.
- ① Deactivate the tow-away alarm in order to prevent inadvertent activation. If you deactivate the tow-away alarm, collision detection will also be deactivated.
You can permanently deactivate collision detection via the multimedia system (→ page 224).

- ① If the battery is severely discharged, the function for detecting a collision on a parked vehicle is automatically deactivated to facilitate the next engine start.

System limits

Detection may be restricted in the following situations:

- the vehicle is damaged without impact, foreexample, if an outside mirror is torn off or the paint is damaged by a key
 - an impact occurs at low speed
 - the electric parking brake is not applied
- ① You are responsible for your vehicle. Convince yourself that your vehicle is free of damage and roadworthy.

Setting collision detection on a parked vehicle

Multimedia system:

→ →  → Settings → Vehicle

→ Open/Close → Vehicle Protection

▶ Activate or deactivate the function via **Collision Notification**.

- ① A maximum of three incidents can be registered. Up to 15 photos are taken for every incident. In the event of another incident, the photos of the first incident will be overwritten if they have not been deleted already.

Activating or deactivating the collision photos function

Note possible legal restrictions in some countries regarding automatic recording of the vehicle surroundings.

▶ Activate or deactivate **Collision Photos**.

Transferring the collision photos with the Mercedes me app

- ▶ Select **Upload Collision Photos**.
- ▶ Select **Upload Automatically**.

▶ Scan the generated QR code on the central display with the Mercedes me app. The encrypted collision photos will then be uploaded to Mercedes me.

- ① Any device that can scan QR codes can be used to view the collision photos in the Mercedes me app.

Copying the collision photos to a USB flash drive

- ▶ Connect a USB flash drive .
- ▶ Select **Manage Collision Photos**.
- ▶ Select **Copy (USB)**.
All collision photos are copied to the USB flash drive.

- ① To ensure secure operation, only use with FAT32 or exFAT formatted USB storage devices.

Deleting collision photos

- ▶ Select **Manage Collision Photos**.
- ▶ Select **Delete**.
All collision photos will be deleted.

Driving and driving safety systems

Driving systems and your responsibility

Your vehicle is equipped with driving systems that assist you in driving, parking and maneuvering the vehicle. The driving systems are only aids. They are not a substitute for you paying attention to your surroundings and do not relieve you of your responsibility pertaining to road traffic law. The driver is always responsible for maintaining a safe distance to the vehicle in front, for vehicle speed, for braking in good time and for staying in lane. Pay attention to the traffic conditions at all times and intervene when necessary. Be aware of the limitations regarding the safe use of these systems.

Driving systems can neither reduce the risk of an accident if you fail to adapt your driving style nor override the laws of physics. They cannot always take into account road, weather or traffic conditions.

- ① Some driving systems can regulate or limit the speed to a previously set value. Draw attention to the stored speed when changing drivers.

Information on vehicle sensors and cameras

Some driving and driving safety systems use cameras as well as radar or ultrasonic sensors to monitor the area in front of, behind or next to the vehicle.

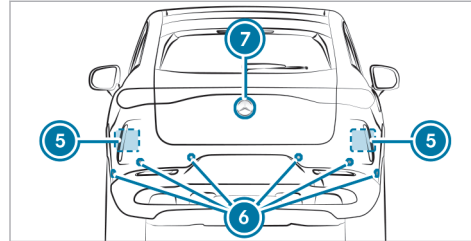
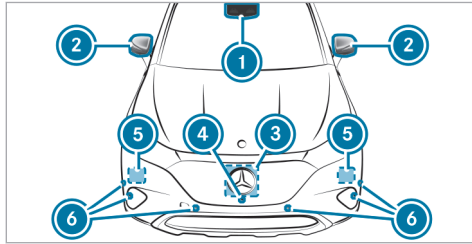

- ① Multifunction camera
- ② Cameras in the outside mirrors
- ③ Front radar
- ④ Front camera
- ⑤ Corner radars
- ⑥ Ultrasonic sensors
- ⑦ Rear view camera

⚠ WARNING Risk of accident due to restricted detection performance of vehicle sensors and cameras

If the area around vehicle sensors or cameras is covered, damaged or dirty, certain driving and safety systems cannot function correctly. There is a risk of an accident.

- ▶ Keep the area around vehicle sensors or cameras clear of any obstructions and clean.
- ▶ Have damage to the bumper, radiator grille or stone chipping in the area of the front and rear windows repaired at a qualified specialist workshop.

Particularly, keep the areas around the sensors and cameras free of dirt, ice or slush (→ page 385). The sensors and cameras must not be covered and the detection ranges around them must be kept free. Do not attach additional license plate brackets, advertisements, stickers, foils or foils to protect against stone chippings in the detection range of the sensors and cameras.

226 Driving and parking

Make sure that there are no overhanging loads protruding into the detection range.

If a bumper or the radiator grill is damaged or after an impact, have the function of the sensors checked at a qualified specialist workshop. Have damage or stone chipping in the area of the cameras on the front and rear windows repaired at a qualified specialist workshop.

- ❗ The rear view camera can extend and retract automatically for the purpose of calibration, even though there is no camera image in the display.

Overview of driving systems and driving safety systems

- ABS (→ page 227)
- BAS (→ page 227)
- ESP® (→ page 228)
- ESP® Crosswind Assist (→ page 229)
- ESP® trailer stabilization (→ page 229)
- EBD (→ page 230)
- STEER CONTROL (→ page 230)

- HOLD function (→ page 230)
- Hill Start Assist (→ page 231)
- Valet service mode (→ page 232)
- Beginner driver mode (→ page 232)
- ATTENTION ASSIST (→ page 233)
- Cruise control (→ page 234)
- DSR (→ page 244)
- Traffic Sign Assist (→ page 259)
- Traffic light view (→ page 263)
- AIRMATIC (→ page 270)

Driving Assistance Package

- ❗ The availability of some functions or sub-functions of the Driving Assistance Package is equipment- or country-specific. The functions of your Driving Assistance Package may differ from the functions listed here. Active Distance Assist DISTRONIC, Active Blind Spot Assist, Active Brake Assist, Active Lane Keeping Assist and Active Emergency Stop Assist are also available without the Driving Assistance Package, albeit with restricted functionality.

- Active Distance Assist DISTRONIC (→ page 237)
- Active Speed Limit Assist (→ page 241)
- Route-based speed adaptation (→ page 242)
- Active Brake Assist (→ page 254)
- Active Steering Assist (→ page 246)
- Active Emergency Stop Assist (→ page 248)
- Active Lane Change Assist (→ page 250)
- Active Stop-and-Go Assist (→ page 244)
- Active Blind Spot Assist with exit warning (→ page 264)
- Active Lane Keeping Assist (→ page 267)
- PRE-SAFE® Impulse Side (→ page 54)

Parking Package

- ❗ The availability of individual functions depends on the country and equipment.
- Rear-view camera (→ page 272)
- 360° camera (→ page 274)
- Parking Assist PARKTRONIC (→ page 280)
- Active Parking Assist (→ page 284)

- Remote Parking Assist (→ page 289)
- Memory Parking Assist (country-dependent) (→ page 297)
- Trailer Maneuvering Assist (→ page 300)

Function of ABS

The Anti-lock Brake System (ABS) regulates the brake pressure in critical driving situations:

- During braking, for instance, at maximum full-stop braking or if there is insufficient tire traction, the wheels are prevented from locking.
- Vehicle steerability while braking is ensured.



If ABS intervenes when braking, you will feel a pulsing in the brake pedal. The pulsating brake pedal can be an indication of hazardous road conditions and can serve as a reminder to take extra care while driving.

System limits

- ABS is active from speeds of approx. 3 mph (5 km/h).
- ABS may be impaired or may not function if a malfunction has occurred and the yellow 

ABS warning lamp lights up continuously after the vehicle is started.

Function of off-road ABS

 Off-road ABS is activated automatically when you select the  drive program.

Off-road ABS is specially adapted for driving off-road:

- The front wheels lock cyclically during braking.
- The braking distance is shortened due to the digging-in effect.

System limits

- Off-road ABS functions at speeds below 25 mph (40 km/h).
- If Off-road ABS intervenes, the ability to steer may be restricted.

Function of BAS

 **WARNING** Risk of an accident caused by a malfunction in BAS (Brake Assist System)

If BAS is malfunctioning, the braking distance in an emergency braking situation is increased.

 Depress the brake pedal with full force in emergency braking situations. ABS prevents the wheels from locking.

The Brake Assist System (BAS) supports your emergency braking situation with additional brake force.

If you depress the brake pedal quickly, BAS is activated:

- BAS automatically boosts the brake pressure.
- BAS can shorten the braking distance.
- ABS prevents the wheels from locking.

The brakes will function as usual once you release the brake pedal. BAS is deactivated.

Function of ESP®

⚠ WARNING Risk of skidding if ESP® is deactivated

If you deactivate ESP®, ESP® cannot carry out vehicle stabilization.

▶ ESP® should only be deactivated in the following situations.

! NOTE Mercedes-AMG vehicles

▶ Observe the notes in the Supplement. You could otherwise fail to recognize dangers.

The Electronic Stability Program (ESP®) can monitor and improve driving stability and traction in the following situations within physical limits:

- When pulling away on wet or slippery roads.
- When braking.

If the vehicle deviates from the direction desired by the driver, ESP® can stabilize the vehicle by intervening in the following ways:

- One or more wheels are braked.
- The drive system output is adapted according to the situation.

When ESP® is deactivated, the  warning lamp lights up continuously:

- Driving stability will no longer be improved.
- The drive wheels could spin.
- ETS/4ETS traction control is still active.

i When ESP® is deactivated, you are still assisted by ESP® when braking.

When the  warning lamp flashes, one or several wheels has reached its grip limit:

- Adapt your driving style to suit the current road and weather conditions.
- Do not deactivate ESP®.
- Only depress the accelerator pedal as far as is necessary when pulling away.

Deactivate ESP® in the following situations to improve traction:

- When using snow chains.
- In deep snow.
- On sand or gravel.

i Spinning the wheels results in a cutting action, which enhances traction.

If the  warning lamp lights up continuously, ESP® is not available due to a malfunction.

Observe the following information:

- Warning and indicator lamps (→ page 523)
- Display messages (→ page 451)

ETS/4ETS (Electronic Traction System)

ETS/4ETS traction control is part of ESP® and makes it possible to pull away and accelerate on a slippery road.

If you select the  drive program, a special ETS system specifically suited to off-road terrain is automatically activated.

ETS/4ETS can improve the vehicle's traction by intervening in the following ways:

- The drive wheels are braked individually if they spin.
- More drive torque is transferred to the wheel or wheels with traction.

Influence of drive programs on ESP®

The drive programs enable ESP® to adapt to different weather and road conditions as well as the driver's preferred driving style. Depending on the selected drive program, the appropriate ESP® mode will be activated (→ page 196).

Function of ESP® Crosswind Assist

ESP® Crosswind Assist detects sudden gusts of side wind and helps the driver to keep the vehicle in the lane:

- ESP® Crosswind Assist is active at vehicle speeds between approx. 50 mph (80 km/h) and 125 mph (200 km/h) when driving straight ahead or cornering slightly.

- The vehicle is stabilized by means of individual brake application on one side.

Function of ESP® trailer stabilization

⚠ WARNING Risk of accident in poor road and weather conditions

In poor road and weather conditions, the trailer stabilization cannot prevent lurching of the vehicle/trailer combination. Trailers with a high center of gravity may tip over before ESP® detects this.

- ▶ Always adapt your driving style to suit the current road and weather conditions.

When you are driving with a trailer, ESP® can stabilize your vehicle if the trailer begins to swerve from side to side:

- ESP® trailer stabilization will be active at speeds above 40 mph (65 km/h).
- Slight swerving is reduced by means of a targeted, individual brake application on one side.

- In the event of severe swerving, the operating energy output will also be reduced and the brakes will be applied to all wheels.

ESP® trailer stabilization may be impaired or may not function if:

- The trailer is not connected correctly or is not detected properly by the vehicle.

Activating/deactivating ESP® (Electronic Stability Program)

Multimedia system:



! **NOTE** Mercedes-AMG vehicles

- ▶ Observe the notes in the Supplement. You could otherwise fail to recognize dangers.

- ▶ Select **ESP**.
- ▶ Select **On** or **Off**.

ESP® is deactivated if the  ESP® OFF warning lamp lights up continuously in the driver's display.

Observe any information on warning lamps and display messages which may be shown in the driver's display.

Function of EBD

Electronic Brakeforce Distribution (EBD) is characterized by the following:

- Monitoring and regulating the brake pressure on the rear wheels.
- Improved driving stability when braking, especially on bends.

Function of STEER CONTROL

STEER CONTROL assists you by transmitting a noticeable steering force to the steering wheel in the direction required for vehicle stabilization.

This steering recommendation is given in the following situations:

- both right wheels or both left wheels are on a wet or slippery road surface when you brake
- the vehicle starts to skid

System limits

STEER CONTROL may be impaired or may not function in the following situations:

- ESP® is deactivated.
- ESP® is malfunctioning.
- The steering is malfunctioning.

If ESP® is malfunctioning, you will be assisted further by the electric power steering.

HOLD function

■ HOLD function

The HOLD function holds the vehicle at a standstill without requiring you to depress the brake pedal, e.g. while waiting in traffic.

The HOLD function is only an aid. The responsibility for the vehicle safely standing still remains with the driver.

System limits

The HOLD function is only intended to provide assistance when driving and is not a sufficient means of safeguarding the vehicle against rolling away when stationary.

- The incline must not be greater than 30%.

■ Activating/deactivating the HOLD function

▲ WARNING Risk of an accident due to the HOLD function being active when you leave the vehicle

If the vehicle is only braked with the HOLD function it could, in the following situations, roll away:

- If there is a malfunction in the system or in the power supply.
- If the HOLD function is deactivated by depressing the accelerator pedal or brake pedal, e.g. by a vehicle occupant.

- ▶ Always secure the vehicle against rolling away before you leave it.

Requirements

- The vehicle is stationary.
- The driver's door is closed or the seat belt on the driver's side is fastened.
- The vehicle has been started.
- The electric parking brake is released.
- Active Distance Assist DISTRONIC is deactivated.
- The transmission is in position **D**, **R** or **N**.

Activating the HOLD function

- ▶ Depress the brake pedal, and after a short time quickly depress further until the **HOLD** display appears in the driver's display.
- ▶ Release the brake pedal.

Deactivating the HOLD function

- ▶ Depress the accelerator pedal to pull away.
- or

- ▶ Depress the brake pedal until the **HOLD** display disappears from the driver's display.

The HOLD function is deactivated in the following situations:

- Active Distance Assist DISTRONIC is activated.
- The transmission is shifted to position **P**.
- The vehicle is secured with the electric parking brake.

In the following situations, the vehicle is held by transmission position **P** and/or by the electric parking brake:

- The seat belt is unfastened and the driver's door is opened.
- The vehicle is switched off.
- There is a system malfunction.
- The power supply is insufficient.

In addition, the **Brake Immediately** message may appear in the driver's display and a horn tone may sound at regular intervals.

- ▶ Immediately depress the brake pedal firmly until the warning message disappears. The HOLD function is deactivated.
- ▶ Additionally secure the vehicle against rolling away.

Function of Hill Start Assist

Hill Start Assist holds the vehicle for a short time when you pull away on a hill under the following conditions:

- The transmission is in position **D** or **R**.
- The electric parking brake is released.

This gives you enough time to move your foot from the brake pedal to the accelerator pedal and depress it before the vehicle begins to roll away.

⚠ WARNING Risk of accident and injury due to the vehicle rolling away

After a short time, Hill Start Assist no longer holds the vehicle.

- ▶ Swiftly move your foot from the brake pedal to the accelerator pedal. Do not

leave the vehicle when it is being held by Hill Start Assist.

Valet service mode

Function of the valet service mode

In valet service mode, the vehicle acceleration is limited to reduce the risk of damage to and improper use of the vehicle when it is handed over to third parties.

Valet service mode is characterized by the following:

- Power output is reduced.
- In principle, a maximum speed of 50 mph (80 km/h) can be reached.
- Drive programs **S*** and **I*** are not available.
- ESP® cannot be deactivated.
- Profiles that are still logged in are logged out and unprotected profiles are secured.

Activating or deactivating valet service mode

Requirements:

- For activation: the vehicle is stationary.
- For deactivation: park position **P** is engaged.

Multimedia system:

→  » Apps » Valet service mode

- ① This function is an on-demand feature (→ page 29).
- ▶ Activate or deactivate the function. If valet service mode is activated, an indicator lamp in the driver's display lights up.
- ① Alternatively, valet service mode can be activated or deactivated via the Mercedes me connect App. Further information on Mercedes me connect (→ page 362)
- ① Valet service mode is protected from deactivation by third parties only in combination with Mercedes me connect. If the vehicle is connected to Mercedes me connect, only the profile that activated the mode or the established main user can deactivate it again.

- ① Valet service mode remains active even following a change of profile or after the vehicle is switched on or off, and must be deliberately deactivated by the authorized user.

Beginner driver mode

Function of beginner driver mode

In beginner driver mode, vehicle acceleration is limited to increase safety for inexperienced drivers.

Beginner driver mode is characterized by the following:

- Power output is reduced.
- In principle, a maximum speed of 75 mph (120 km/h) can be reached.
- Drive programs **S*** and **I*** are not available.
- ESP® cannot be deactivated.

Activating or deactivating beginner driver mode

Requirements:

- For activation: the vehicle is stationary.

- For deactivation: park position **P** is engaged.

Multimedia system:

→  → Apps → Beginner driver mode

- ① This function is an on-demand feature (→ page 29).
- ▶ Activate or deactivate the function. If beginner driver mode is activated, an indicator lamp in the driver's display lights up.
- ① Alternatively, beginner driver mode can be activated or deactivated via the Mercedes me connect app. Further information on Mercedes me connect (→ page 362)
- ① Beginner driver mode is protected from deactivation by third parties only in combination with Mercedes me connect. If the vehicle is connected to Mercedes me connect, only the profile that activated the mode or the established main user can deactivate it again.
- ① Beginner driver mode remains active even following a change of profile or after the vehicle is switched on or off, and must be deliberately deactivated by the authorized user.

ATTENTION ASSIST

Function of ATTENTION ASSIST

ATTENTION ASSIST assists you on long, monotonous journeys, e.g. on highways and trunk roads. If indicators of fatigue or increasing lapses in concentration on the part of the driver are detected, the system suggests taking a break.

ATTENTION ASSIST is only an aid. It cannot always detect fatigue or lapses in concentration in time. The system is not a substitute for a well-rested and attentive driver. On long journeys, take regular breaks in good time that allow for adequate recuperation.

You can choose between two settings:

- **Standard:** normal system sensitivity.
- **Sensitive:** higher system sensitivity. The driver is warned earlier and the attention level detected by ATTENTION ASSIST is adapted accordingly.

If fatigue or increasing inattention is detected, the warning appears in the driver display: **ATTENTION ASSIST: Take a Break!** You can acknowledge the message and take a break if necessary.

If you do not take a break and ATTENTION ASSIST continues to detect increasing lapses in concentration, you will be warned again after a minimum of 15 minutes.

If ATTENTION ASSIST is unable to calculate the attention level and cannot issue a warning, the **System Suspended** message appears.



If the driver display shows a warning, a service area search is offered in the multimedia system. You can select a rest area and start navigation to this rest area.

When you restart the vehicle, ATTENTION ASSIST is automatically switched on. The last selected sensitivity level remains stored.



234 Driving and parking

The following information is displayed in the driver's display:

- The length of the journey since the last break
- The attention level determined by ATTENTION ASSIST:
 - The more segments  of the circle displayed, the higher the detected attention level.
 - Fewer segments  are displayed in the circle as the attention level decreases.

System limits

ATTENTION ASSIST is active in the 37 mph (60 km/h) to 124 mph (200 km/h) speed range.

The microsleep detection function is available at a speed of 12 mph (20 km/h) and above.

If the system is not available due to an error, the ATTENTION ASSIST warning light is permanently lit  in the driver display

Particularly in the following situations, ATTENTION ASSIST functions only in a restricted manner and warnings may be delayed or not occur:

- If you have been driving for less than approximately 30 minutes.
- If the road condition is poor (uneven road surface or potholes).
- If there is a strong side wind.
- If you adopt a sporty driving style (high cornering speeds or high rates of acceleration).
- If the Steering Assist function of Active Distance Assist DISTRONIC is active.
- If the clock is set to the incorrect time.
- If you change lanes and vary your speed frequently in active driving situations.

Also observe any information regarding display messages that can be displayed in the driver's display.

The ATTENTION ASSIST drowsiness or alertness assessment is reset and restarted when continuing the journey in the following situations:

- You switch off the vehicle.



- If you unfasten your seat belt and open the driver's door (e.g. to change drivers or take a break).

Setting ATTENTION ASSIST

Multimedia system:

  **Settings**  **Assistance**
 **Assistance**  **ATTENTION ASSIST**

Setting the sensitivity

-  Select  next to **ATTENTION ASSIST**.
-  Select **Standard** or **Sensitive**.

Speed control cruise control

Function of cruise control

Cruise control regulates the speed to the value selected by the driver.

If you accelerate to overtake, for example, the stored speed is not deleted. If you remove your foot from the accelerator pedal after overtaking, cruise control will resume speed regulation back to the stored speed.



You can store any speed above 15 mph (20 km/h) up to the maximum design speed, or

up to the speed recommended by Range Assistant.

Observe the notes on driving systems and your responsibility; you may otherwise fail to recognize dangers (→ page 224).

Mercedes-AMG vehicles: cruise control is available up to a maximum speed of 155 mph (250 km/h).

Displays in the driver's display

-  (gray): cruise control is selected but not yet active, or temporarily passive.
-  (green): cruise control is active.

A stored speed appears under the  display and is indicated in the speedometer.

System limits

Cruise control may be unable to maintain the stored speed on uphill gradients. The stored speed is resumed when the gradient evens out. Increase recuperation in good time on long and steep downhill gradients. Take particular note of this when driving a laden vehicle. By doing so, you will make use of the electric motor's braking

effect to charge the high-voltage battery. This relieves the load on the brake system and prevents the brakes from overheating and wearing too quickly.

Do not use cruise control in the following situations:

- in traffic situations which require frequent changes of speed, e.g. in heavy traffic, on winding roads
- on slippery roads. Accelerating can cause the drive wheels to lose traction and the vehicle could then skid.
- when visibility is poor

Operating cruise control

⚠ WARNING Risk of accident due to stored speed

If you call up the stored speed and this is lower than your current speed, the vehicle decelerates.

- ▶ Take into account the traffic situation before calling up the stored speed.

Requirements

- Cruise control is selected.
- ESP® must be activated, but not intervening.
- The vehicle speed is at least 15 mph (20 km/h).
- The transmission is in position **D**.

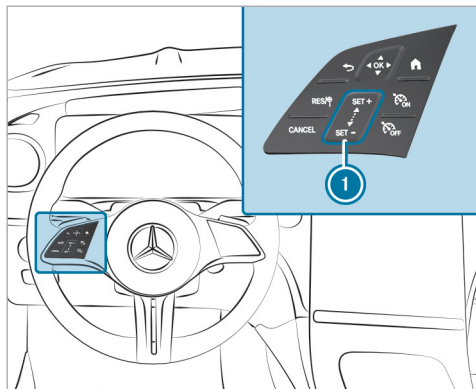

Steering wheel control panel for cruise control

- Adopts the stored/detected speed
- Deactivates cruise control
- Switches cruise control on
- Switches cruise control off
- ① Control panel to increase/reduce speed

Switching cruise control on

- ▶ Press .

Activating cruise control

- ▶ Press or on control panel ①.
The current speed is stored and maintained by the vehicle.
 - or
 - ▶ Press .
- The last stored speed is called up and maintained by the vehicle.
- If the last stored speed has previously been deleted, the current vehicle speed is stored.

① When you switch off the vehicle, the last speed stored is deleted.

Increasing/reducing the stored speed

- ▶ To increase the stored speed: swipe upwards from the bottom of control panel ①.
 - The stored speed is increased by 1 mph (1 km/h).
- ▶ To reduce the stored speed: swipe downwards from the top of control panel ①.
 - The stored speed is reduced by 1 mph (1 km/h).

or

- ▶ Briefly press or on control panel ①.

The stored speed is increased or reduced to the following values depending on the unit:

- **mph:** the next value ending in 5
- **km/h:** the next value ending in 0

or

- ▶ Accelerate the vehicle to the desired speed.
- ▶ Press on control panel ①.

Adopting a detected speed

If cruise control is activated and Traffic Sign Assist has detected a speed restriction sign with a maximum permissible speed and this is displayed on the driver's display:

- ▶ Press .
- The maximum permissible speed shown by the traffic sign is stored and the vehicle maintains this speed.

Deactivating cruise control

- ▶ Press .

Switching cruise control off

▶ Press .

- ❗ If you brake, deactivate ESP® or if ESP® intervenes, cruise control is deactivated.

Active Distance Assist DISTRONIC

■ Function of Active Distance Assist DISTRONIC

- ❗ The Active Distance Assist DISTRONIC described for vehicles without the Driving Assistance package is an on-demand feature (→ page 29).

DISTRONIC Active Distance Assist maintains the set speed when driving freely. If vehicles are detected ahead, the set distance is maintained, if necessary until the vehicle comes to a standstill. The vehicle accelerates or brakes depending on the distance to the vehicle in front and the set speed. The speed and distance to the vehicle in front are set and saved using the steering wheel.

Available speed range:

- **Vehicles without Driving Assistance Package:**
15 mph (20 km/h) - 100 mph (160 km/h)
- **Vehicles with Driving Assistance Package:**
15 mph (20 km/h) - 130 mph (210 km/h)

- ❗ The adjustable set speed may differ if a limit speed (e.g. winter tire limit) is stored.
- ❗ If Active Distance Assist DISTRONIC is active and the range monitor recommends a lower driving speed, this is automatically adopted as the new set speed. If necessary, the setting speed can be increased again manually.

Other features of Active Distance Assist DISTRONIC:

- Adjusts the driving style depending on the selected drive program (energy-saving, comfortable or dynamic) (→ page 195)
- Initiates acceleration to the stored speed if the turn signal indicator is switched on to change to the overtaking lane
- **Vehicles with Driving Assistance Package:**
 - Reacts to stationary vehicles detected in urban speed ranges (except bicycles and motorcycles)
 - Takes into account one-sided overtaking restrictions on highways or on multi-lane roads with separate roadways (country-dependent)

- ❗ In the DYNAMIC SELECT menu, it is possible to set the driving mode of the Active Distance Assist DISTRONIC. Depending on which drive program is selected, the driving characteristics can be geared towards energy economy, comfort or dynamic performance. In the Active Distance Assist menu, the driving style can be permanently set to Comfort or Dynamic (→ page 243).

Vehicles with Active Parking Assist and Driving Assistance Package: if Active Distance Assist DISTRONIC has braked the vehicle to a standstill, it can automatically follow the vehicle in front when driving off again within 30 seconds if the system detects that the driver is holding the steering wheel. If a critical situation is detected in the surrounding area when driving off, such as a person in the vehicle path, a visual and acoustic warning is given indicating that the driver must now take control of the vehicle. The vehicle is not accelerated any further.

Observe the notes on driving systems and your responsibility; you may otherwise fail to recognize dangers (→ page 224).

Display in the driver's display in the Assistance menu

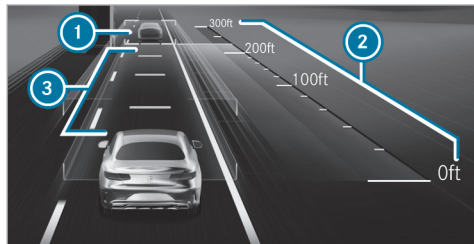

- ① Vehicle in front
- ② Distance indicator
- ③ Set specified distance

Vehicle detected in front ① is highlighted in green. It may also be in the lane to the left of your vehicle in situations where it is not permitted to overtake on the right, for example on highways.

Permanent status display

- (gray): Active Distance Assist DISTRONIC selected but not yet active

- (green speedometer, gray vehicle): Active Distance Assist DISTRONIC active, speed set
- (green): Active Distance Assist DISTRONIC active and vehicle detected

The stored speed is shown under the permanent status display and highlighted on the speedometer. When Active Distance Assist DISTRONIC is passive, the status display is grayed out.

If the speed of the vehicle in front or the speed adjustment is less than the stored speed due to the route event ahead, the segments in the speedometer light up.

When the set specified distance is increased or reduced, the display briefly appears.

- ① The green vehicle symbol is displayed cyclically when the vehicle is ready to drive.
- ① If you depress the accelerator pedal beyond the setting of the Active Distance Assist DISTRONIC, the system is switched to passive mode. The following message appears briefly in the driver's display **Suspended**.

System limits

The system may be impaired or may not function in the following situations, for example:

- In snow, rain, fog, heavy spray, if there is glare, in direct sunlight or in greatly varying ambient light.
- The windshield in the area of the camera is dirty, fogged up, damaged or covered.
- If the radar sensors are dirty or covered.
- In parking garages or on roads with steep uphill or downhill gradients.
- If there are narrow vehicles in front, such as bicycles or motorcycles.

In addition, on slippery roads, braking or accelerating can cause one or several wheels to lose traction and the vehicle could then skid.

Do not use Active Distance Assist DISTRONIC in these situations.

⚠ WARNING Risk of accident from acceleration or braking by Active Distance Assist DISTRONIC

Active Distance Assist DISTRONIC may accelerate or brake in the following cases, for example:

- If the vehicle pulls away using Active Distance Assist DISTRONIC.
- If the stored speed is called up and is considerably faster or slower than the currently driven speed.
- If Active Distance Assist DISTRONIC no longer detects a vehicle in front or does not react to relevant objects.

- ▶ Always carefully observe the traffic conditions and be ready to brake at all times.
- ▶ Take into account the traffic situation before calling up the stored speed.

⚠ WARNING Risk of accident due to insufficient deceleration by Active Distance Assist DISTRONIC

Active Distance Assist DISTRONIC brakes your vehicle with up to 50% of the possible deceleration. If this deceleration is not sufficient, Active Distance Assist DISTRONIC alerts you with a visual and acoustic warning.

- ▶ Adjust your speed and maintain a suitable distance from the vehicle in front.
- ▶ Brake the vehicle yourself and/or take evasive action.

⚠ WARNING Risk of accident if detection function of Active Distance Assist DISTRONIC is impaired

Active Distance Assist DISTRONIC does not react or has a limited reaction:

- when driving on a different lane or when changing lanes

- to pedestrians, animals, bicycles or stationary vehicles, or unexpected obstacles
- to complex traffic conditions
- to oncoming vehicles and crossing traffic

As a result, Active Distance Assist DISTRONIC may neither give warnings nor intervene in such situations.





- ▶ Always observe the traffic conditions carefully and react accordingly.

■ Operating Active Distance Assist DISTRONIC

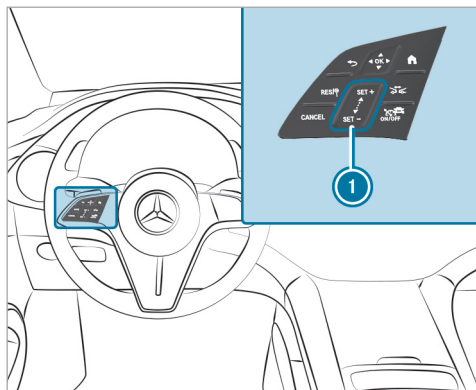
Requirements

- The electric parking brake is released.
- ESP® is activated and is not intervening.
- The transmission is in position **D**.
- All the doors are closed.
- Check of the radar sensor system has been successfully completed.
- Snow chain mode is not active (→ page 410).
- DSR is deactivated.
- Drive program  is deactivated.



-  Adopts the stored/detected speed
-  Deactivates Active Distance Assist DISTRONIC
-  Increases/decreases the speed
-  Increases/decreases the specified distance
-  Activates/deactivates Active Distance Assist DISTRONIC

- ▶ To operate Active Distance Assist DISTRONIC: press the respective button with only one finger or swipe on the control panel.

Activates/deactivates Active Distance Assist DISTRONIC

- ▶ Press .

Activating Active Distance Assist DISTRONIC

- ▶ To activate without a stored speed: on control panel  press **SET/+** on the upper section or **SET/-** on the lower section or **RES/SET**. Remove your foot from the accelerator pedal.

or

- ▶ To activate with a stored speed: press **RES/SET**. Remove your foot from the accelerator pedal. The last stored speed is called up and maintained by the vehicle.

If the stored speed has been deleted, the current vehicle speed is stored.

Increasing or reducing the speed

- ▶ To increase the stored speed: swipe upwards from the bottom of control panel .

- The stored speed is increased by 1 mph (1 km/h).

- ▶ To decrease the stored speed: swipe downwards from the top of control panel .

- The stored speed is decreased by 1 mph (1 km/h).

or

- ▶ Briefly press **SET/+** on the upper section or **SET/-** on the lower section of control panel .

The stored speed is increased or reduced by 5 mph (10 km/h).

or

- ▶ Accelerate the vehicle to the desired speed.
- ▶ Press **SET/+** on the upper section of control panel .

Adopting the limit speed shown in the driver's display

- ▶ Activate the Active Distance Assist DISTRONIC: Press **SET/+**, **SET/-** or **RES/⊙**.
- ▶ Accept the displayed speed limit: press **RES/⊙**. The limit speed displayed in the driver's display is adopted as the stored speed. The vehicle adapts its speed to that of the vehicle in front, but only up to the stored speed, or limits its speed accordingly.

i A speed limit shown in the driver display is adopted only while the vehicle is in motion, not when stationary.



Pulling away with Active Distance Assist DISTRONIC

- ▶ Activate Active Distance Assist DISTRONIC and remove your foot from the brake pedal.
- ▶ Press **RES/⊙**.

or

- ▶ Depress the accelerator pedal briefly and firmly. The functions of Active Distance Assist DISTRONIC continue to be carried out.

Reducing or increasing the specified distance from the vehicle in front

- ▶ Press . The  display appears. The specified distance is reduced by one level. If the lowest level is already selected, the selection jumps to the highest level.

Deactivating Active Distance Assist DISTRONIC

⚠ WARNING Risk of an accident due to Active Distance Assist DISTRONIC being active when you leave the driver's seat

If you leave the driver's seat while the vehicle is being braked by Active Distance Assist DISTRONIC only, the vehicle can roll away.

- ▶ Always deactivate Active Distance Assist DISTRONIC and secure the vehicle to prevent it from rolling away before you leave the driver's seat.

- ▶ Press **CANCEL**.

i If you brake, deactivate ESP® or if ESP® intervenes, Active Distance Assist DISTRONIC is deactivated.

Function of Active Speed Limit Assist

If a changed speed limit is detected and the automatic adoption of speed limits is switched on, this is automatically adopted as the stored speed (→ page 243). Speed limits below 12 mph (20 km/h) are not accepted.

The driven speed is adjusted when the vehicle is level with the traffic sign at the latest. In the case of signs indicating entry into an urban area, the speed is adapted according to the speed permitted within the urban area. The speed limit display in the driver's display is always updated when the vehicle is level with the traffic sign.

If you are driving on German highways and there is no speed limit, the system uses the speed stored for a stretch of road with no speed limit as the set speed. If you do not alter the stored speed on a stretch of road with no speed limit, the recommended speed of 80 mph (130 km/h) is adopted.

If the driver has put Active Distance Assist DISTRONIC into passive mode by pressing the accelerator pedal, only speed limits that are higher than the set speed are adopted.

The maximum permissible speed does not take into account the road condition and current weather and traffic conditions. Adjust your speed accordingly, when necessary.

Observe the notes on driving systems and your responsibility; you may otherwise fail to recognize dangers (→ page 224).

System limits

The system limits of Traffic Sign Assist apply to the detection of traffic signs (→ page 259).

Speed limits below 12 mph (20 km/h) are not automatically adopted by the system as the stored speed. Temporary speed restrictions (e.g. for a certain time or due to weather conditions) cannot be properly detected by the system.

The maximum permissible speed applying to a vehicle with a trailer is not detected by the system.

Adjust the speed in these situations.

⚠ WARNING Risk of accident due to Active Speed Limit Assist adapting the vehicle's speed

The speed adopted by Active Speed Limit Assist may be too high or incorrect in some individual cases, such as:

- at speed limits below 12 mph (20 km/h)
- in wet conditions or in fog
- when towing a trailer

▶ Ensure that the driven speed complies with traffic regulations.

▶ Adjust the driving speed to suit current traffic and weather conditions.

■ Function of route-based speed adaptation

When Active Distance Assist DISTRONIC is activated, the vehicle speed will be adapted accordingly to the route events ahead. Depending on the drive program selected, the vehicle negotiates a route event ahead in an energy-saving, comfortable or dynamic manner. When the route event has been passed, the vehicle accelerates again to the stored speed. The set distance to the vehicle in

front, vehicles detected ahead and speed restrictions ahead are taken into account.

Route-based speed adaptation can be activated in the multimedia system (→ page 243).

The following route events are taken into account:

- Bends
- Traffic circles
- T-intersections
- Turns and exits
- Traffic jams ahead (only with Live Traffic)

Also, the speed is reduced if the turn signal indicator is switched on and one of the following situations is detected:

- Turning at intersections
- Driving in slowing-down lanes
- Driving in lanes adjacent to slowing-down lanes

The driver is responsible for choosing the right speed and observing other road users. This applies in particular to intersections, traffic circles

and traffic lights, as route-based speed adaptation does not brake the vehicle to a standstill.

Speed adaptation is canceled in the following cases:

- If the turn signal indicator is switched off before the route event and it is therefore assumed that the route event is not relevant to the driver.
- If the driver depresses the accelerator or brake pedal during the process.

System limits

Route-based speed adaptation does not take right of way regulations into account. The driver is responsible for complying with road traffic regulations and driving at a suitable speed.

In difficult conditions, the speed selection made by the system may not always be suitable. This applies to the following situations, for example:

- The road's course is not clearly visible.
- Road narrowing.
- Varying maximum permissible speeds in individual lanes, for example at toll stations.
- Wet road surfaces, snow or ice.

- If transport equipment, for example a trailer or bicycle rack, is attached to the trailer hitch and the electrical connection has been correctly established.

In these situations the driver must intervene accordingly.

⚠ WARNING Risk of accident in spite of route-based speed adaptation

Route-based speed adaptation can malfunction or be temporarily unavailable in the following situations:

- If the driver does not follow the calculated route
- If map data is not up-to-date or available
- In the event of roadworks
- In bad weather or road conditions
- If the accelerator pedal is depressed
- In the event of electronically displayed speed limitations

▶ Adapt the speed to the traffic situation.

Setting Active Distance Assist DISTRONIC driving styles

Requirements

- Active Distance Assist DISTRONIC is activated.

Multimedia system:

🏠 ▶ Settings ▶ Assistance
▶ Driving ▶ Active Distance Assist

Selecting a driving style

▶ Select **Based on DYNAMIC SELECT**, **Dynamic** or **Comfortable**.

📘 Further information about Active Distance Assist DISTRONIC (→ page 239).

Setting speed adaptation

▶ Select **Adopt Speed Limit** or **Route-based Speed Adaptation**.

When these functions are active, the vehicle speed is adjusted depending on the route events ahead.

- ① When one of the following systems is active, the detected speed can be manually adopted as the speed limit:
 - Active Distance Assist DISTRONIC
 - Cruise control
 - Variable limiter
- ① Further information on speed adaptation (→ page 242).

■ Function of Active Stop-and-Go Assist

Active Stop-and-Go Assist helps you when in traffic jams on multi-lane roads with separate roadways by automatically pulling away within up to 60 seconds and with moderate steering maneuvers. It orients itself using the vehicle in front and lane markings. Active Stop-and-Go Assist automatically maintains a safe distance from the vehicle in front and vehicles cutting in.

Active Stop-and-Go Assist requires you, as the driver, to keep your hands on the steering wheel at all times so that you are able to intervene at any time to correct the course of the vehicle and keep it in lane.

Observe the notes on driving systems and your responsibility; you may otherwise fail to recognize dangers (→ page 224).

Active Stop-and-Go Assist activates automatically when all of the following conditions are met:

- You are in a traffic jam on a highway or high-speed major road.
- Active Distance Assist DISTRONIC is activated and active (→ page 239).
- Active Steering Assist is activated and active (→ page 248).
- You are traveling no faster than 35 mph (60 km/h).

When Active Stop-and-Go Assist is active the  status display appears on the driver's display.

System limits



The system limitations of Active Distance Assist DISTRONIC and Active Steering Assist apply to Active Stop-and-Go Assist (→ page 246).

DSR (Downhill Speed Regulation)

■ Function of DSR

DSR is an aid to assist you when driving downhill. It keeps the speed of travel at the selected target speed. The steeper the downhill gradient, the greater the DSR braking effect on the vehicle. On flat stretches of road and uphill gradients, the DSR brakes the vehicle minimally or not at all.

When DSR is activated and the transmission is in position **D**, **R** or **N**, DSR controls the driving speed. The target speed can be set to a value between 1 mph (2 km/h) and 11 mph (18 km/h). By braking or accelerating, you can drive at a higher or lower speed than the target speed at any time.

If you drive faster than 28 mph (45 km/h) or change the drive program (except in ) , DSR switches off automatically. The  **Off** message appears on the driver's display. The status indicator on the driver's display goes out. You also hear a warning tone.

Information on DSR

⚠ WARNING Risk of skidding and accident when DSR is activated on slippery road surfaces

If the driven speed and the target speed differ, the wheels may lose traction.

- ▶ Take into account the road surface and the difference between the driving speed and target speed before activating DSR.

Observe the notes on driving systems and your responsibility; you may otherwise fail to recognize dangers (→ page 224).

You are always responsible for keeping control of the vehicle and for assessing whether the downhill gradient can be negotiated. Depending on road surface and tires, DSR may not always be able to keep to the target speed. Select a target speed suitable for the environmental conditions and also apply the brakes yourself if required.

Activating or deactivating DSR (Downhill Speed Regulation)

Requirements

- You are driving at 24 mph (40 km/h) or slower.
If the vehicle speed is too high, the **Max. speed 40 km/h** message appears on the driver's display.
- Active Distance Assist DISTRONIC, cruise control, the variable limiter and recuperation level DAuto are switched off.

Multimedia system:

→  ▶ Settings ▶ Assistance

- ▶ Select .
A status display appears on the driver's display when the function is activated.

Changing the target speed

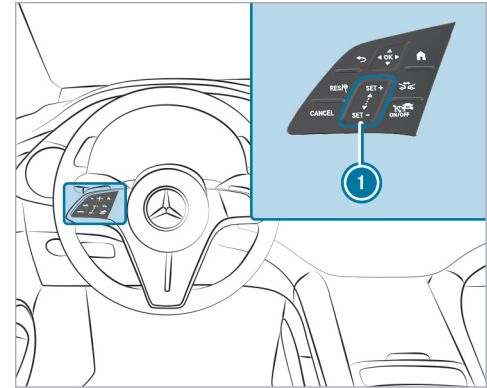

- ▶ **To increase the target speed:** swipe upwards from the bottom of control panel .
 - The target speed is increased by 1 mph (1 km/h).

or

▶ Press and hold **1** at **SET+** the top of the control panel.

The target speed is increased in 1-mph (1-km/h) increments.

▶ **To decrease the target speed:** swipe downwards from the top of control panel **1**.

- The target speed is decreased by 1 mph (1 km/h).

or

▶ Press and hold **1** at **SET-** the bottom of the control panel.

The target speed is 1-mph (reduced in 1-km/h) increments.

The set target speed is shown  next to the status display in the driver's display.

Active Steering Assist

Function of Active Steering Assist

Active Steering Assist is available only up to a speed of 130 mph (210 km/h). The system helps you to stay in the center of the lane by means of moderate steering interventions. Depending on the speed driven, Active Steering Assist uses the vehicles ahead and lane markings as a reference.

- i** Depending on the country, in the lower speed range Active Steering Assist can use the surrounding traffic as a reference. If necessary, Active Steering Assist can then also provide assistance outside the center of the lane.

If the detection of lane markings and vehicles ahead is impaired, Active Steering Assist switches to passive mode. The system provides no support in this case.

Permanent status display in the driver's display





Gray: activated and passive



Green: activated and active



Red, flashing: prompt to the driver to actively confirm or transition from active to passive status, system limit detected

- i** During the transition from active to passive status, the  symbol is shown as enlarged and flashing. Once the system is passive, the  symbol is grayed out in the driver's display.

Contact detection

The driver is required to keep their hands on the steering wheel at all times and be able to inter-

vene at any time to correct the course of the vehicle and keep it in lane. The driver must expect a change from active to passive mode or vice versa at any time.

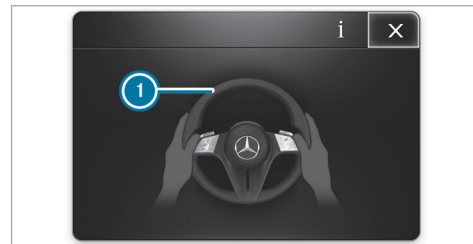

If the system detects that the driver has not steered the vehicle for a considerable period of time or has removed their hands from the steering wheel, an optical warning is given first. Display **1** appears in the driver's display. If the driver still does not steer the vehicle, or gives no confirmation to the system, a warning tone sounds in addition to the visual warning message.

If the driver does not react to this warning for a considerable period, an emergency stop is initiated (→ page 248).

The warning is not issued or is stopped as soon as the system detects that the driver has touched the steering wheel.

The touch detection may be limited or may not function if there is no direct contact between the hand and steering wheel, e.g. when the driver is wearing gloves or there is a steering wheel cover on the steering wheel.

If Active Steering Assist detects that a system limit has been reached, a visual warning is issued and a warning tone sounds.

Observe the notes on driving systems and your responsibility; you may otherwise fail to recognize dangers (→ page 224).

System limits

Active Steering Assist has a limited steering torque for lateral guidance. In some cases, the steering intervention is not sufficient to keep the vehicle in the lane.

The system may be impaired or may not function in the following instances:

- There is poor visibility, e.g. due to snow, rain, fog, heavy spray, greatly varying ambient light or strong shadows on the road.
- There is glare, e.g. from oncoming traffic, direct sunlight or reflections.
- Insufficient road illumination.
- The windshield is dirty, fogged up, damaged or covered in the vicinity of the camera, e.g. by a sticker.
- No, or several, unclear lane markings are present for one lane, or the markings change quickly, foreexample, in a construction area or intersections.
- The lane markings are worn away, dark or covered up, e.g. by dirt or snow.
- If the distance to the vehicle in front is too short and thus the lane markings cannot be detected.
- The road is narrow and winding.
- There are obstacles on the lane or projecting out into the lane, such as object markers.

- If transport equipment, foreexample a trailer or bicycle rack, is attached to the trailer hitch and the electrical connection has been correctly established.

The system does not provide assistance in the following conditions:

- On very tight bends and when turning.
- When crossing intersections.
- At traffic circles or toll stations.
- When actively changing lane without switching on the turn signal indicator.
- When the tire pressure is too low.

⚠ WARNING Risk of accident if Active Steering Assist unexpectedly stops functioning

If the system limits of Active Steering Assist are reached there is no guarantee that the system will remain active or will keep the vehicle in lane.

- ▶ Always keep your hands on the steering wheel and observe the traffic carefully.

- ▶ Always steer the vehicle paying attention to traffic conditions.

⚠ WARNING Risk of accident if Active Steering Assist unexpectedly intervenes

The detection of lane markings and objects may malfunction and cause unexpected steering interventions.

- ▶ Steer according to traffic conditions.

■ Activating/deactivating Active Steering Assist

Requirements

- ESP® is activated, but is not intervening.
- Active Distance Assist DISTRONIC is activated.

Multimedia system:

→  ▶ Settings ▶ Assistance

▶▶ Driving

- ▶ Activate or deactivate **Active Steering Assist**.

Function of Active Emergency Stop Assist

Active Emergency Stop Assist monitors the steering wheel and the accelerator and brake pedals. If the system detects a lack of driver activity and the vehicle threatens to leave the lane, a warning can be issued and an emergency stop initiated.

Vehicles without Driving Assistance Package: The system is available from a speed of approx. 37 mph (60 km/h).

Vehicles with Driving Assistance package: If Active Steering Assist is switched off, the system is available from a speed of approx. 37 mph (60 km/h).

If the system detects that the vehicle is threatening to leave the lane, a warning can be issued and an emergency stop initiated.

- The driver does not touch the steering wheel for a longer period of time or no steering movement can be measured for a longer period of time (depending on the vehicle equipment).
- Neither the accelerator nor the brake pedal is depressed.

- ⓘ **Vehicles with Driving Assistance package:** if Active Steering Assist is switched on and active, only the steering wheel is monitored by the system. If the driver does not touch the steering wheel for a longer period of time, a warning may be given despite pedal actuation. Also observe the instructions on the contact detection of Active Steering Assist (→ page 246).



Active Emergency Stop Assist issues the following warnings in order:

- Display message ⓘ appears in the driver's display.

- In addition to display  a warning tone sounds.
- The message **Initiating Emergency Stop** will appear in the driver's display, a continuous warning tone will sound, the vehicle will no longer accelerate and, if necessary, slight belt tensioning will be produced.
- The vehicle speed is reduced in increments until it is at a standstill. Sharp brake impulses are also produced.

 **Vehicles with Driving Assistance Package:** If Active Distance Assist DISTRONIC is active and the driver unfastens the seat belt and driver's door, an emergency stop can be initiated immediately.

Vehicles with Driving Assistance Package:

Depending on the country, a lane change to the adjacent lane is carried out, if possible. It is possible only to change across one lane and only into the outer lane, and not onto the hard shoulder.

When automatic braking is initiated, Active Distance Assist DISTRONIC is deactivated. Depending on the country, the hazard warning light system is switched on.

When the vehicle is stationary, the following actions are carried out:

- The vehicle is secured with the electric parking brake.
- The vehicle is unlocked.
- If possible, an emergency call is placed to the Mercedes-Benz emergency call center.

Before automatic braking is initiated, you can cancel Active Emergency Stop Assist by steering.

You can cancel the intervention by Active Emergency Stop Assist after automatic braking is initiated by one of the following actions:

- Accelerating or braking: the emergency stop is canceled, but the warning message, warning tone and power steering remain active
 - Steering: power-assisted steering is canceled, the warning message and warning tone remain active and the vehicle continues to be braked
-  Active Emergency Stop Assist can initiate an emergency stop a maximum of three times within a driving cycle. After that, Active Steering Assist and Active Emergency Stop Assist

are disabled until the vehicle has been restarted.

System limits

For the detection of vehicles and other obstacles, observe the system limits of the following functions:

- Active Distance Assist DISTRONIC (→ page 237)
- Active Steering Assist (→ page 246)
- Active Lane Change Assist (→ page 250)
- Active Brake Assist (→ page 254)

Vehicles without Driving Assistance Package:

Active Emergency Stop Assist is inactive in the following cases:

- Active Lane Keeping Assist has reached a system limit.
- Active Lane Keeping Assist is not operational (gray status display) or deactivated (white status display) (→ page 267).

Active Lane Change Assist

Function of Active Lane Change Assist

Active Lane Change Assist helps the driver with changing lanes and is activated when the driver indicates briefly.



This requires the following conditions to be fulfilled:

- You are on a freeway or similar road.
- The vehicle speed is between approximately 40 mph (65 km/h) and 110 mph (180 km/h).
- The neighboring lane is separated by a dashed lane marking.
- No vehicle or obstacle is detected in the adjacent lane.
- Active Lane Change Assist is selected in the multimedia system.
- Active Distance Assist DISTRONIC and Active Steering Assist are switched on and active.

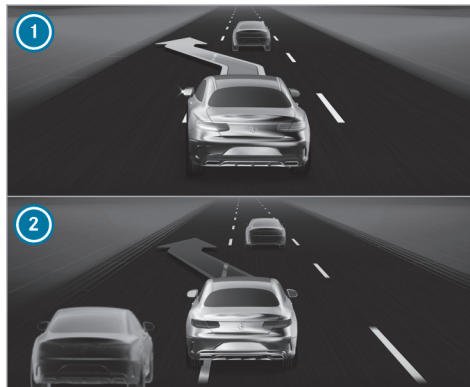
Indicators on the driver's display on the menu **Assistance**



- ① Green arrow: lane change initiated
- ② Red arrow: lane change canceled

When Active Lane Change Assist is available, the  display will appear along with green arrows on the driver's display. If the system has been activated but is not currently available, the 

display will appear along with grey arrows on the driver's display.

If no vehicle or obstacle is detected in the adjacent lane and a lane change is permitted, the lane change will begin after the driver has indicated briefly. The lane change will be shown to the driver with a flashing green arrow next to the  steering wheel symbol. Green arrow ① will be displayed in the appropriate adjacent lane on the **Assistance** menu on the driver's display. The **Lane Change to the Left** message, for example, will also appear.

If a lane change is not possible directly after the driver has activated the turn signal indicator because an obstacle has been detected, for example, the arrow will also flash in green next to the  steering wheel symbol and the neighboring lane will continue to be monitored. When the lane becomes clear, a lane change will be carried out and the **Lane Change to the Left** message, for example, will appear on the driver's display. If the green arrows stop flashing, the lane change must be activated again.

Active Lane Change Assist can be canceled in various situations, including the following:

- Change in the surrounding conditions (e.g. detected obstacle).
- The driver steers too sharply or in the opposite direction.
- The driver moves the turn signal indicator in the opposite direction.
- Active Distance Assist DISTRONIC or Active Steering Assist is deactivated.
- The vehicle cannot make the lane change as planned.

Cancellation of Active Lane Change Assist will be displayed as follows:

- The arrow in the selected direction of travel turns red.
- A corresponding message will also appear on the driver's display.
- In certain circumstances, a warning tone will sound.

⚠ WARNING Risk of accident when changing lane to an occupied adjacent lane

Lane Change Assist cannot always clearly detect if the adjacent lane is free.

The lane change might be initiated although the adjacent lane is not free.

- ▶ Before changing lanes, make sure that the neighboring lane is free and there is no danger to other road users.
- ▶ Monitor the lane change.

⚠ WARNING Risk of accident if Lane Change Assist unexpectedly stops functioning

If the system limitations for Lane Change Assist have been reached, there is no guarantee that the system will remain active.

Lane Change Assist cannot then assist you by applying steering torque.

- ▶ Always monitor the lane change and keep your hands on the steering wheel. Observe the traffic conditions and steer and/or brake if necessary.

Automated Lane Change

Automated Lane Change is a sub-function of Active Lane Change Assist. It can provide assistance to the driver in deciding when a lane change is appropriate and in executing it.

⚠ WARNING Risk of accident due to incorrectly triggered lane change

The system cannot always clearly recognize all situations in which a lane change is appropriate.

The system can initiate a lane change even though the traffic situation is not suitable or the neighboring lane is not available, not usable or occupied.

- ▶ Always monitor the traffic situation.
- ▶ If necessary, cancel the lane change by holding the steering wheel or counter-steering slightly and return the vehicle to its own lane.

You can cancel a lane change initiated by the system at any time by holding the steering wheel or

countersteering slightly and returning the vehicle to its own lane.

For Automated Lane Change to function, the following conditions must be met:

- The conditions for activating Active Lane Change Assist are fulfilled.
- Automated Lane Change is activated in the multimedia system.
- You are driving on a freeway in a country where the function is available.
- The road currently being traveled allows for lane changes; for example, there are no tight bends.
- The vehicle speed is between approximately 40 mph (65 km/h) and 85 mph (140 km/h).

Active Lane Change Assist can initiate an Automated Lane Change in the following situations:

- The set desired speed of the Active Distance Assist DISTRONIC cannot be reached due to a slower vehicle in front.
- There is little traffic and the set desired speed of the Active Distance Assist DISTRONIC can also be reached in a slower lane.

- A lane change is necessary to follow the set route in the navigation system. The lane change can take place before the request to do so appears in the navigation system.
- The system detects that the lane being traveled in will end soon.
- You are in the lane furthest to the right.

In particular, Active Lane Change Assist will not carry out an Automated Lane Change in the following situations:

- If the vehicle is already in a lane that it should use to follow the set route in the navigation system.
- If it is necessary to change lanes to a highway exit to follow the set route in the navigation system.
- On some route sections, there will be no lane change to the lanes furthest to the right.
- The system detects that the neighboring lane will end soon.
- If an Automated Lane Change has been canceled by the driver, no lane change will be initiated in that direction for a certain time.

- If the driver has initiated a lane change in one direction or has actively changed lanes, no lane change in the opposite direction will be initiated for a certain time.



The same abort conditions apply to Automated Lane Change as to driver-initiated lane change with Active Lane Change Assist.

In addition, Automated Lane Change can be canceled in the following circumstances in particular:

- The system detects a construction site marked off by traffic cones in the vehicle's own lane or in the neighboring lane during the lane change.
- The system detects that the reason for the lane change no longer exists.

Indicators on the driver's display

When Automated Lane Change is turned on, the **Automatic Lane Change On** message will appear.

When Automated Lane Change is available, the  display will appear in green instead of the  display. If Automated Lane Change is available but not all conditions are currently met, the **A** symbols will be greyed out. If the system deems it

advisable to change lanes and needs to adjust the traveled speed to do so, the green **A** will flash on the side to which a lane change is to be made.

When Automated Lane Change starts, for example, the **Lane Change to the Left** message will appear and a warning tone will sound.

When Automated Lane Change is canceled, the **A** on the side to which a lane change should be made will turn red. In addition, additional warning messages may appear and another warning tone may sound in certain situations.

System limits

The system limitations of Active Steering Assist apply to Active Lane Change Assist (→ page 246).

The system may also be impaired or may not function in the following situations:

- The sensors are damaged, obscured or dirty (→ page 225).
- The exterior lighting shows a defect.
- The system does not detect a suitable road, such as on tight bends.
- The vehicle is at a construction site.

Automated Lane Change may not function or may be impaired in the following situations in particular and could lead to lane changes being initiated incorrectly:

- The vehicle is at a construction site and/or the system has detected a construction site that is marked off by traffic cones.
 - The system can no longer detect the lane marking correctly.
 - It is raining heavily.
 - Another vehicle changes to the same lane at the same time, e.g. when the vehicle is passing an on-/off-ramp.
- i** The Active Lane Change Assist sensors will adjust automatically while a certain distance is being driven after the vehicle has been delivered. Active Lane Change Assist will be unavailable or only partially available during this teach-in process, and no arrows will be displayed next to the  Active Steering Assist symbol.

Observe the notes on driving systems and your responsibility; you may otherwise fail to recognize dangers (→ page 224).

Setting Active Lane Change Assist

Multimedia system:

-  **» Settings » Assistance**
- » Driving » Active Lane Change Assist**
- ▶ Select Active Lane Change Assist.**
- ▶ Choose between the On or Off (Off) setting options.**
- ▶ Choose between the On, Also Automatically and Off (Off) setting options.**

The **Also Automatically** setting option can also be switched on and off on the quick-access menu.

- i** If **Active Steering Assist** has been switched off, it will not be possible to operate **Active Lane Change Assist**.

Active Brake Assist

Function of Active Brake Assist



Active Brake Assist consists of the following functions:

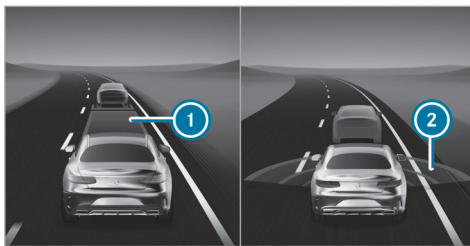

- Collision warning
- Autonomous braking function
- Situation-dependent brake force boosting
- Cornering Assist
- **Vehicles with Driving Assistance Package:** Evasive Steering Assist
- **Vehicles with Driving Assistance Package:** Intersection start-off function

Active Brake Assist can help you to minimize the risk of a collision with vehicles, cyclists or pedestrians or to reduce the effects of such a collision.

If Active Brake Assist has detected a risk of collision, a warning tone sounds and the  distance warning lamp lights up.



In the **Assistance** menu, an insufficient distance  to the vehicle in front is displayed in red. If you further reduce the distance, the vehicle in front is also highlighted in red. When the system detects a risk of collision, red radar waves  appear in front of the vehicle.

-  **Vehicles with PER-SAFE®:** depending on the country, an additional haptic warning occurs in the form of slight, repeated tensioning of the seat belt.
-  **Vehicles with active ambient lighting:** if **Warning Support** is activated, the Active Brake Assist warning is also accompanied by ambient lighting (→ page 155).

If you do not react to the warning, autonomous braking can be initiated in critical situations.

In particularly critical situations, Active Brake Assist can also initiate autonomous braking directly. In this case, the distance warning lamp  and the warning tone will occur at the same time as brake application.

If you apply the brake yourself in a critical situation or apply the brake during autonomous braking, situation-dependent brake force boosting will occur. The brake pressure increases up to maximum full-stop braking if necessary.



If autonomous braking or situation-dependent brake force boosting has occurred, pop-up  will

appear on the driver's display and then automatically disappear after a short time.

If the autonomous braking function or the situation-dependent brake force boosting is triggered, additional preventive measures for occupant protection (PER-SAFE®) may also be initiated.

⚠ WARNING Risk of an accident caused by limited detection performance of Active Brake Assist

Active Brake Assist cannot always clearly identify objects and complex traffic situations.

In such cases, Active Brake Assist might:

- Give a warning or brake without reason
- Not give a warning or not brake

Active Brake Assist is only an aid. The driver is responsible for maintaining a sufficiently safe distance to the vehicle in front, vehicle speed and for braking in good time.

▶ Always pay careful attention to the traffic situation; do not rely on Active Brake Assist alone.

▶ Be prepared to brake or swerve if necessary.

If Active Brake Assist is deactivated or the functions are restricted, e.g. due to activation of another driving system, the  Active Brake Assist warning lamp will appear on the driver's display.

If the system is unavailable due to dirty or damaged sensors or due to a malfunction, or if the functions are restricted, the  Active Brake Assist warning lamp will appear on the driver's display.

Also observe the system limits of Active Brake Assist.

The individual subfunctions are available in the following speed ranges:

Collision warning

Collision warning can assist you in the following situations from approximately 4 mph (7 km/h) with an intermittent warning tone and the  distance warning lamp.

Vehicles without Driving Assistance Package:

- at speeds up to approximately 155 mph (250 km/h) when approaching vehicles ahead
- at speeds up to approximately 50 mph (80 km/h) when approaching stationary vehicles, pedestrians walking in the direction of travel and cyclists ahead
- at speeds up to approximately 43 mph (70 km/h) when approaching crossing pedestrians and cyclists
- at speeds up to approximately 37 mph (60 km/h) when approaching stationary pedestrians and cyclists

Vehicles with Driving Assistance Package:

- at speeds up to approximately 155 mph (250 km/h) when approaching vehicles ahead
- at speeds up to approximately 75 mph (120 km/h) when approaching crossing vehicles, pedestrians and cyclists
- at speeds up to approximately 62 mph (100 km/h) when approaching stationary vehicles

256 Driving and parking

- at speeds up to approximately 50 mph (80 km/h) when approaching cyclists ahead
- at speeds up to approximately 43 mph (70 km/h) when approaching stationary pedestrians and cyclists

Autonomous braking function

If the vehicle is traveling at speeds above approximately 4 mph (7 km/h), the autonomous braking function may intervene in the following situations:

Vehicles without Driving Assistance Package:

- at speeds up to approximately 155 mph (250 km/h) when approaching vehicles ahead
- at speeds up to approximately 50 mph (80 km/h) when approaching cyclists ahead, pedestrians walking in the direction of travel and stationary vehicles
- at speeds up to approximately 43 mph (70 km/h) when approaching crossing pedestrians and cyclists

Vehicles with Driving Assistance Package:

- at speeds up to approximately 155 mph (250 km/h) when approaching vehicles ahead

- at speeds up to approximately 75 mph (120 km/h) when approaching crossing vehicles, pedestrians and cyclists
- at speeds up to approximately 62 mph (100 km/h) when approaching stationary vehicles
- at speeds up to approximately 50 mph (80 km/h) when approaching cyclists ahead
- at speeds up to approximately 43 mph (70 km/h) when approaching stationary pedestrians and cyclists

Situation-dependent brake force boosting

If the vehicle is traveling at speeds above approximately 4 mph (7 km/h), situation-dependent brake force boosting may intervene in the following situations.

Vehicles without Driving Assistance Package:

- at speeds up to approximately 155 mph (250 km/h) when approaching vehicles ahead
- at speeds up to approximately 50 mph (80 km/h) when approaching cyclists ahead, pedestrians walking in the direction of travel and stationary vehicles

- at speeds up to approximately 43 mph (70 km/h) when approaching crossing pedestrians and cyclists
- at speeds up to approximately 37 mph (60 km/h) when approaching stationary pedestrians and cyclists

Vehicles with Driving Assistance Package:

- at speeds up to approximately 155 mph (250 km/h) when approaching vehicles ahead
- at speeds up to approximately 75 mph (120 km/h) when approaching crossing vehicles, pedestrians and cyclists
- at speeds up to approximately 62 mph (100 km/h) when approaching stationary vehicles
- at speeds up to approximately 50 mph (80 km/h) when approaching cyclists ahead
- at speeds up to approximately 43 mph (70 km/h) when approaching stationary pedestrians and cyclists

Canceling a brake application of Active Brake Assist

You can cancel a brake application of Active Brake Assist at any time by:

- Fully depressing the accelerator pedal or with kickdown.
- Releasing the brake pedal.

Active Brake Assist may cancel the brake application when one of the following conditions is fulfilled:

- you maneuver to avoid the obstacle
- there is no longer a risk of collision
- an obstacle is no longer detected in front of your vehicle

Reaction to oncoming road users (only vehicles with Driving Assistance Package)

Active Brake Assist can also react to detected oncoming road users:

- Reaction up to speeds of approximately 62 mph (100 km/h)
- Warning for oncoming road users via acoustic warning and distance warning lamp 

- Autonomous braking application in order to reduce the severity of an accident



Cornering function

If the system detects a danger of collision from oncoming road users when turning across an oncoming lane, autonomous braking can be initiated at speeds of up to approx. 12 mph (20 km/h).

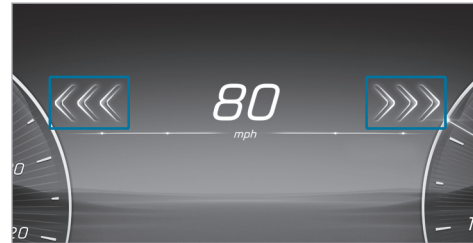
Intersection start-off function (only vehicles with Driving Assistance Package)



If a risk of collision with other crossing vehicles is detected when you are pulling away or driving at walking pace, three red arrows pointing in the

direction of the crossing road user together with the  distance warning lamp will light up on the driver's display. If the situation is particularly critical, the arrows will flash. A warning tone will also sound. If you do not react to the warning in critical situations, acceleration may be restricted or autonomous braking may be initiated. Autonomous braking can also prevent the vehicle from pulling away and hold it at a standstill. In particularly critical situations, Active Brake Assist can also initiate autonomous braking directly. In this case, the distance warning lamp  and the warning tone will occur at the same time as brake application.

If autonomous braking or situation-dependent brake force boosting has occurred, a pop-up will appear on the driver's display and then automatically disappear after a short time.

In the [Late](#) setting of Active Brake Assist, the purely visual warning level and the limitation of possible acceleration is deactivated. If the situation is particularly critical, a visual warning can still be issued, a warning tone can be emitted and autonomous braking may be initiated.

Evasive Steering Assist

⚠ WARNING Risk of accident despite Evasive Steering Assist

Evasive Steering Assist cannot always recognize objects or complex traffic situations clearly.

Moreover, the steering support provided by Evasive Steering Assist is not sufficient to avoid a collision.

- ▶ Always pay careful attention to the traffic situation; do not rely on Evasive Steering Assist alone.
- ▶ Be prepared to brake or swerve if necessary.
- ▶ End the support by actively steering in non-critical situations.
- ▶ Drive at an appropriate speed if there are pedestrians close to the path of your vehicle.

Evasive Steering Assist has the following characteristics:

- Detection of pedestrians, cyclists and vehicles.
- Assistance through power-assisted steering if it detects a swerving maneuver.
- Activation by an abrupt steering movement during a swerving maneuver.
- Assistance during swerving and straightening of the vehicle.
- Reaction from a speed of approximately 12 mph (20 km/h) up to a speed of approximately 68 mph (110 km/h).

The steering support of Evasive Steering Assist can be canceled at any time by counter-steering.

System limits

Full system performance is not available for a short time after switching on the vehicle or after driving off. As long as the functions are restricted, the  Active Brake Assist warning lamp can also be shown on the driver's display. Depending on the environmental conditions, it may take a

few minutes before full system performance is available.

The system may be impaired or may not function, particularly in the following situations:

- In snow, rain, fog, heavy spray, if there is glare, in direct sunlight or in greatly varying ambient light.
- If the sensors are dirty, fogged up, damaged or covered. (→ page 225)
- If the sensors are impaired due to interference from other radar sources, e.g. strong radar reflections in parking garages.
- If a loss of tire pressure or a defective tire has been detected and displayed.
- In complex traffic situations where objects cannot always be clearly identified.
- If pedestrians, cyclists or vehicles move quickly into the sensor detection range.
- If road users are hidden by other objects or are located close to other objects.
- If the typical outline of a pedestrian or cyclist cannot be distinguished from the background.

- If a pedestrian or cyclist is not detected as such, e.g. due to special clothing or other objects.
- If the driver's seat belt is not fastened.
- On bends with a tight radius.

■ Setting Active Brake Assist

Requirements

- The vehicle is switched on.

Multimedia system:

→  » Settings » Assistance
» Collision Avoidance

- ▶ Activate or deactivate the function.
- ⓘ It is recommended that you always leave Active Brake Assist activated.

When Active Brake Assist is deactivated, the distance warning function, the collision warning, the autonomous braking function and Evasive Steering Assist are deactivated.

- ⓘ If Active Brake Assist is deactivated, the  symbol appears in the status bar of the driver's display, and the system is reactivated the next time the vehicle is started.

Setting the time of the warnings

- ▶ Select  next to **Active Brake Assist**.
- ▶ Select **Early**, **Medium** or **Late**.

Traffic Sign Assist

■ Function of Traffic Sign Assist

The traffic sign assistant detects the traffic signs with the multifunction camera and compares them with the information on the digital road map of the navigation system. It assists you by displaying detected speed limits and overtaking restrictions on the driver display. The maximum permissible speed can also be shown on the head-up display.

The system can issue a warning when you exceed the maximum permissible speed.

In some countries, the system can provide you with further functions and can warn you when you are approaching pedestrian crossings or when you are about to drive past stop signs or red lights unintentionally.

The camera also detects and analyzes traffic signs with a restriction indicated by an additional sign (e.g. when wet).

Traffic Sign Assist portrays only selected signs in the driver's display. Actual traffic signs and speed limits have priority over traffic signs and speed limits shown in the driver's display.

Also observe the following information:

- select a speed adapted to the traffic, surroundings and weather conditions
- observe actual traffic signs
- observe applicable traffic rules and regulations

Observe the notes on driving systems and your responsibility; you may otherwise fail to recognize dangers (→ page 224).

Displays in the driver's display

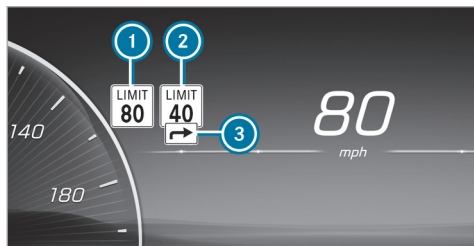

- ① Permissible speed
- ② Permissible speed when there is a restriction
- ③ Additional sign with restriction

The system can show up to two traffic signs in the driver's display simultaneously. The system always prioritizes displaying speed limits. Up to one traffic sign with a maximum permissible speed can be shown in the head-up display. If two speed signs are shown in the driver display, e.g. in the case of detected restrictions, the value of the left-hand speed limit ① is always transmitted to the TEMPOMAT or Active Distance Assist DISTRONIC for acceptance and shown in the head-up display.

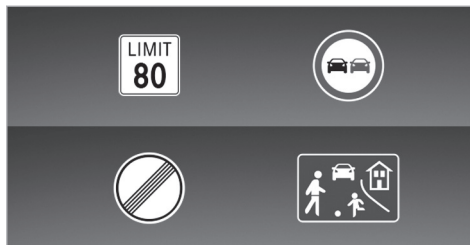

Examples of traffic signs that can be displayed

Traffic Sign Assist can detect and display following traffic signs ①:

- speed limits
- end of the speed limit
- overtaking restrictions
- play streets
- recommended speeds

Traffic Sign Assist can detect following additional signs ③ and, if necessary, analyze the relevance of the restrictions using other vehicle sensors:

- when wet

- slippery road surfaces
- in fog
- temporary restrictions
- exits
- restrictions for car/trailer combinations

Traffic Sign Assist also uses data from the digital street map in the navigation system. When you leave or enter a municipality or change roads, on a highway exit or slip road for example, or after you turn at an intersection, the display in the driver's display can thus be updated without a traffic sign having been detected.

- ① Regularly update the digital road map of the navigation system so that the traffic sign assistant can work optimally.

Depending on vehicle equipment and country, the system can also display speed restrictions ahead in the driver's display and in the head-up display. The driver's display can also show the distance to an upcoming lower limit speed. For this purpose, information from the digital road map of the navigation system is used. The **Assistance** menu can

also display a dynamic visualization of the speed limits ahead.

If Traffic Sign Assist cannot determine the currently applicable maximum permissible speed (e.g. due to missing signs), the following display appears in the driver's display:



Traffic Sign Assist is not available in all countries. If the vehicle is in a country where Traffic Sign Assist is not supported, this is displayed continuously.

If Traffic Sign Assist is temporarily or permanently unavailable due to a technical fault or if the windshield is dirty, the Traffic Sign Assist warning lamp  appears on the driver display.

- i** Please also note the information on the display messages of the traffic sign assistant (→ page 451).

Warning when the maximum permissible speed is exceeded

The system can warn you if you unintentionally exceed the maximum permissible speed. Depending on the country, you can set in the multimedia system by how much the maximum permitted speed may be exceeded before a warning is given. You can switch off the warning or set whether the warning should be visual (by flashing the traffic sign in the driver display) or visual and audible. The selected setting is confirmed by an indication in the driver's display.

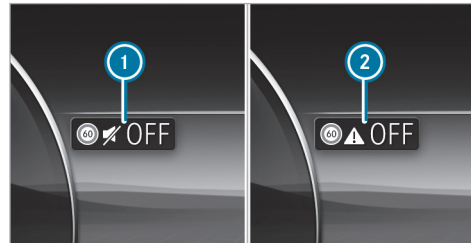

- 1** Warning only visual
- 2** WARNING off

- i** The type, duration and deployment stage of the speed warning as well as the possibility of setting the deployment stage above which the warning is to be triggered are subject to the country-specific legislation of the country of delivery of the vehicle.

Additional functions of Traffic Sign Assist (country-specific)

Warning for no-entry signs: Traffic Sign Assist can warn you if you drive the wrong way down a section of road, for example on highway slip roads or one-way streets.

Warning at pedestrian crossings: if you approach pedestrian crossings, provided that pedestrians are in the danger zone or are moving towards it, Traffic Sign Assist can warn you up to a speed of approximately 44 mph (70 km/h).

Warning at stop signs: Traffic Sign Assist can warn you up to a speed of approximately 44 mph (70 km/h) if you are about to drive past a stop sign unintentionally. For this to be possible, the signs must be clear, for example if the system detects more than one stop sign, or a stop sign can be confirmed using the digital navigation

map. No warning can be issued if several different signs are detected.

Warning at red lights: Traffic Sign Assist can warn you up to a speed of approximately 44 mph (70 km/h) if you are about to drive through a red light unintentionally.

The following conditions must be fulfilled:

- Several traffic lights have been detected.
 - All traffic lights detected are red.
 - At least one of the red traffic lights detected is on the front passenger side beside the vehicle's own lane.
 - The traffic lights are in the following sequence (from top to bottom): red, yellow, green.
- i** If the function is available, you can activate or deactivate the warnings at pedestrian crossings, stop signs and red lights in the Traffic Sign Assist menu under [Further Warnings](#) (→ page 263).

System limits

The system may be impaired or may not function particularly in the following situations:

- If visibility is poor, e.g. due to insufficient illumination of the road, highly variable shade conditions, rain, snow, fog, swirling dust or heavy spray.
- If there is glare, e.g. from oncoming traffic, direct sunlight or reflections.
- If there is dirt on the windshield in the vicinity of the multifunction camera or if the camera is fogged up, damaged or obscured.
- If the traffic signs are difficult to see because, for example, they are dirty, obscured, faded, iced over, damaged, inconveniently positioned, insufficiently illuminated or distorted.
- Active traffic signs with LED displays may not be detected correctly or at all due to technical factors, such as transmission frequency.
- If the information on the navigation system's digital map is incorrect, incomplete or out of date.
- If the signs, road markings or road layout are ambiguous, e.g. in the case of traffic signs in construction sites, at exits and driveways, in the case of adjacent lanes or parallel roads, in the case of pedestrian crossing markings at traffic lights
- if the signage or road markings do not comply with the standard
- if the signage, road markings or road guidance is country-specific and deviates from the route guidance of the navigation system, e.g. in or after road works
- After sharp turns and tight bends, when traffic signs are outside the camera's field of vision.
- If you overtake vehicles with traffic signs that are affixed or attached to them.
- If you are using transport equipment secured to the vehicle with a trailer coupling, such as a bicycle rack, restrictions for car/trailer combinations may be considered valid if applicable.

Setting Traffic Sign Assist

Multimedia system:

-  » Settings » Assistance
 » Assistance » Traffic Sign Assist

Activating or deactivating the speed warning

- ▶ Switch off **Speed Limit Warning**.
 The speed warning remains off according to country-specific legislation until the next time the vehicle is switched on or off and the driver's door is opened.

Change the type of speed warning

- ▶ Change the warning to **Visual only** or **Visual and acoustic**.

Setting the warning threshold

This value determines the speed at which a warning is issued when exceeded.

- ▶ Set the desired speed under Warning Threshold.

Activating or deactivating further functions of Traffic Sign Assist

- ▶ Switch further warning contents on or off.
 The available functions are switched on or off.

Set the type of warning for other functions

- ▶ Select **Visual only** or **Visual and acoustic**.

Traffic light view

Information about the traffic light view

The traffic light view supports the driver when waiting in front of a red light by displaying the camera image on the central display. The camera image is displayed when the driver is the first vehicle in front of the red light and faded out when the vehicle drives off.

Displaying traffic light view

Requirements:

- The **Traffic Light View** option is switched on.
- A traffic light view is available.



Multimedia system:

-  » Settings » Assistance
 » Assistance » Traffic Light View

 This function is not available in all countries.

If the vehicle is in first position at a traffic light, the camera image with traffic light view is shown on the central display.

When the vehicle pulls away, the camera image is faded out.

- ▶ Activate  or deactivate  **Traffic Light View**.

Using other available functions

- ▶ Select .
- ▶ Select **On Request** or **Automatic**.
 If **On Request** is set and a traffic light view is available, the **Tap Here for Traffic Light View** message is displayed. The camera image is shown after confirmation of the message.
 When **Automatic** is set, the camera image is automatically displayed when the traffic light view is available.

Blind Spot Assist and Active Blind Spot Assist

Function of Blind Spot Assist and Active Blind Spot Assist with exit warning

Blind Spot Assist and Active Blind Spot Assist use radar sensors to monitor the area up to 130 ft (40 m) behind and 10 ft (3 m) next to your vehicle.

The system can detect vehicles traveling from speeds of approximately 8 mph (12 km/h) and issue a warning if they move into the monitoring range.

Status display in the driver's display



Gray: the system is activated but inoperative.



Green: the system is activated and operational.

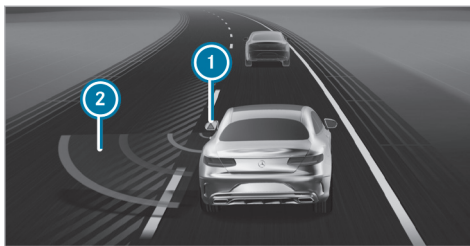

Display in the driver's display in the menu **Assistance**

If a vehicle is detected at speeds above approximately 8 mph (12 km/h) and this vehicle enters the warning range immediately afterwards, the warning lamp in the corresponding outside mirror lights up red. In the **Assistance** menu, the lamp in outside mirror ① also lights up red, and the lane in which the vehicle is detected is hatched out.

If a vehicle is detected in the warning range and you switch on the turn signal indicator in the corresponding direction, a double warning tone sounds once, and the warning lamp flashes red in the corresponding outside mirror. Red radar

waves ② are displayed next to your vehicle in the assistance graphic.

If the turn signal indicator remains on, the display in the outside mirror flashes for all other detected vehicles, but no further warning tone sounds. If you overtake a vehicle quickly, no warning is given.

Observe the notes on driving systems and your responsibility; you may otherwise fail to recognize dangers (→ page 224).



WARNING Risk of accident despite Blind Spot Assist

Blind Spot Assist does not react to vehicles approaching and overtaking you at a greatly different speed.

Blind Spot Assist cannot warn drivers in this situation.

▶ Always pay careful attention to the traffic situation and maintain a safe distance at the side of the vehicle.

Exit warning

The exit warning is an additional function of Blind Spot Assist and Active Blind Spot Assist and can warn vehicle occupants attempting to leave a stationary vehicle about approaching vehicles.

⚠ WARNING Risk of accident despite exit warning

The exit warning neither reacts to stationary objects nor to persons or road users approaching you at a greatly differing speed.

The exit warning cannot warn drivers in these situations.

- ▶ Always pay particular attention to the traffic situation when opening the doors and make sure there is sufficient clearance.

If a vehicle is detected in the monitoring range, the red warning lamp lights up in the corresponding outside mirror.

If a vehicle occupant pulls the door handle on the side of the warning, a warning tone sounds twice and the ambient lighting in the respective door

and the warning lamps in the corresponding outside mirror flash red.

- ① **Vehicles with ambient lighting:** the **Warning Support** of the ambient lighting can be activated and deactivated (→ page 155).
- ① The warning assistance can differ depending on the equipment and may vary according to the setting.

This exit warning is only available when Blind Spot Assist is active.

After the vehicle is switched off, the exit warning continues to function for a few minutes. When the outside mirror warning lamp flashes three times, the exit warning is no longer available.

The exit warning is only an aid and not a substitute for the attention of vehicle occupants. The responsibility for opening and closing the doors and for leaving the vehicle remains with the vehicle occupants.

System limits

Blind Spot Assist and Active Blind Spot Assist may be limited in the following situations, in particular:

- if there is dirt on the sensors or the sensors are obscured
- in poor visibility, e.g. due to fog, heavy rain or snow
- if there are narrow vehicles, e.g. bicycles or motorbikes
- if the road has very wide or narrow lanes
- if vehicles are not driving in the middle of their lane

Warnings may be issued in error when driving close to crash barriers or similar continuous lane borders. Always make sure that there is sufficient distance to the side for other traffic or obstacles.

Warnings may be interrupted when driving alongside long vehicles, for example trucks, for a prolonged time.

Blind Spot Assist and Active Blind Spot Assist are not operational when reverse gear is engaged.

Blind Spot Assist and Active Blind Spot Assist are not operational if transport equipment, for example a trailer or bicycle rack, is attached to the trailer hitch and the electrical connection has been correctly established.

Additionally, the exit warning may be limited in the following situations:

- when the sensors are covered by adjacent vehicles in narrow parking spaces
- when people approach the vehicle
- in the event of stationary or slowly moving objects

Function of the brake application of Active Blind Spot Assist

i The brake application function is only available for vehicles with a Driving Assistance Package.

If Active Blind Spot Assist detects a risk of a side impact in the monitoring range, a course-correcting brake application is carried out. This is designed to help you avoid a collision.

The course-correcting brake application is available in the speed range between approximately

20 mph (30 km/h) and approximately 125 mph (200 km/h).

⚠ WARNING Risk of accident despite brake application of Active Blind Spot Assist

A course-correcting brake application cannot always prevent a collision.

- ▶ Always steer, brake or accelerate yourself, especially if Active Blind Spot Assist warns you or makes a course-correcting brake application.
- ▶ Always maintain a safe distance at the sides.



If a course-correcting brake application occurs, the red warning lamp flashes in the outside mirror and a warning tone sounds. In addition, a display **i** indicating the danger of a side collision appears in the driver's display.

In rare cases, the system may make an inappropriate brake application. This brake application may be interrupted at any time if you steer slightly in the opposite direction or accelerate.

System limits

Either a course-correcting brake application appropriate to the driving situation, or none at all, may occur especially in the following situations:

- Vehicles or obstacles, e.g. crash barriers, are located on both sides of your vehicle.
- A vehicle approaches too closely on the side.
- You have adopted a sporty driving style with high cornering speeds.
- You brake or accelerate significantly.
- A driving safety system intervenes, e.g. ESP® or Active Brake Assist.
- ESP® is deactivated.

- A loss of tire pressure or a defective tire is detected.
- Transport equipment, for example a trailer or bicycle rack, is attached to the trailer hitch and the electrical connection has been correctly established.

■ Activating/deactivating Blind Spot Assist or Active Blind Spot Assist

Multimedia system:

-  >> Settings >> Assistance
- >> Collision Avoidance
- ▶ Activate or deactivate **Active Blind Spot Assist**.

Active Lane Keeping Assist

■ Function of Active Lane Keeping Assist

Active Lane Keeping Assist monitors the area in front of your vehicle by means of the multifunction camera (→ page 225) and can warn you before you leave your lane unintentionally. The system can guide you back into your lane through a course-correcting steering intervention and additionally warns you with vibration pulses in the

steering wheel. Active Lane Keeping Assist is available in the speed range between 37 mph (60 km/h) and 124 mph (200 km/h).

The system can intervene in the following situations:

- Active Lane Keeping Assist detects a lane marking.
- One of your front wheels goes over a lane marking.

If you activate the turn signal indicator, a steering intervention does not occur on the corresponding side.

If you leave the lane without activating the turn signal indicator, but danger of a collision with a moving obstacle is detected in your lane, a steering intervention does not occur.

Vehicles with Blind Spot Assist or Driving Assistance Package: if the system detects an obstacle, such as another vehicle in the adjacent lane, a steering intervention will occur regardless of the turn signal indicator.

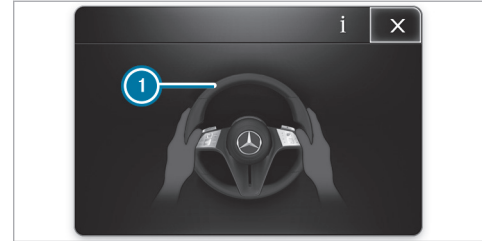

Display ① will appear in the driver's display and a warning tone will sound in the following situations:

- A steering intervention by Active Lane Keeping Assist lasts longer than approximately ten seconds.
- The system carries out two or more steering interventions within approximately three minutes without any steering intervention from the driver.

In the Active Lane Keeping Assist settings, you can set the sensitivity of the system and set the level of support. Additionally, you can set whether the system should react to discontinuous lane

markings or only continuous lane markings (→ page 269).

Status displays for Active Lane Keeping Assist



White: Active Lane Keeping Assist is deactivated.

If ESP® is deactivated or a tire pressure loss warning is displayed, Active Lane Keeping Assist is automatically deactivated.



Yellow: there is a malfunction. Please also observe the display messages.



Gray: Active Lane Keeping Assist is activated, but not operating.



Green: Active Lane Keeping Assist is activated and operating. If the system is operational on only one side, the lane marking is shown in green on the corresponding side.



Red: Active Lane Keeping Assist has guided you back into your lane with a course-correcting steering intervention. The status display will flash if there is also a haptic warning in the steering wheel. The lane

marking is shown in red only on the side for which there is a warning.

Vehicles without Driving Assistance Package: if both lane markings are simultaneously shown in red in the status display, Active Lane Keeping Assist has initiated an emergency stop (→ page 248).

Active Lane Change Assist display in the "Assistance" menu



If the front wheel of the vehicle drives over a detected lane marking, this will be highlighted red in the **Assistance** menu in the driver's display.

ⓘ Vehicles with active ambient lighting: if **Warning Support** is activated, the Active Lane Keeping Assist warning is also accompanied by ambient lighting (→ page 155).

System limits

In the following situations, a lane-correcting steering intervention may not occur but rather a warning may be given on the steering wheel, depending on the situation:

- You clearly and actively steer, brake or accelerate.
- If a driving safety system intervenes, such as ESP®, Active Brake Assist or Active Blind Spot Assist.
- You have adopted a sporty driving style with high cornering speeds or high rates of acceleration.
- If transport equipment, foreexample a trailer or bicycle rack, is attached to the trailer hitch and the electrical connection has been correctly established.

The system may be impaired or may not function particularly in the following situations:

- If there is poor visibility, e.g. due to insufficient illumination of the road, highly variable shade conditions, rain, snow, fog or heavy spray.
- If there is glare, e.g. from oncoming traffic, the sun or reflections.
- If there is dirt on the windshield in the vicinity of the multifunction camera or if the camera is fogged up, damaged or obscured.
- If there is dirt on the bumper in the area of the radar sensors, or if they are damaged or covered.
- If there are no lane markings, or several unclear lane markings are present for one lane, e.g. around roadworks.
- If the lane markings are worn, dark or covered.
- If the distance to the vehicle in front is too short and thus the lane markings cannot be detected.
- If the lane markings change quickly, e.g. lanes branch off, cross one another or merge.

- If the road is very narrow and winding.

Observe the notes on driving systems and your responsibility; you may otherwise fail to recognize dangers (→ page 224).

■ Activating/deactivating Active Lane Keeping Assist

Multimedia system:

-  » Settings » Assistance
- » Collision Avoidance
- » Active Lane Keeping Assist

- ▶ Activate or deactivate the function.

Alternatively, Active Lane Keeping Assist can be activated and deactivated via the quick vehicle access .

- ⓘ After starting the vehicle, the settings are country-specific.

■ Setting Active Lane Keeping Assist

Multimedia system:

-  » Settings » Assistance
- » Collision Avoidance
- » Active Lane Keeping Assist

Setting the sensitivity

- ▶ Select .
- ▶ Select **Early**, **Med.** or **Late**.

The last selected setting will be adopted the next time the vehicle is started.

- ⓘ The standard setting for this function is dependent on the country.

Activating or deactivating assistance on discontinuous lane markings

- ▶ Select **Advanced Support**.

The last selected setting will be adopted the next time the vehicle is started.

- ⓘ The standard setting for this function is dependent on the country.

- ⓘ This function must be activated in vehicles without Driving Assistance Package, so that Emergency Stop Assist is fully available. Further information on Emergency Stop Assist (→ page 248)

AIRMATIC

Function of AIRMATIC

AIRMATIC is an air suspension system with variable damping for improved driving comfort. The all-round level control system ensures the best possible suspension and constant ground clearance, even with a laden vehicle. When driving at speed, the vehicle is lowered automatically to improve driving safety and to reduce energy consumption. You also have the option of manually adjusting the vehicle level.

AIRMATIC includes the following components and functions:

- air suspension with automatic all-round level control
- ADS PLUS (Adaptive Damping System with constant adjustment of damping characteristics)

- speed-dependent lowering of the vehicle level
- increased vehicle level for greater ground clearance, selected via the multimedia system

Suspension setting and vehicle level per drive program

Drive programs **C**, **E** and **S**:



- a comfortable suspension setting in drive programs **C** and **E**
- a firmer, sporty suspension setting in drive program **S**
- adjusting the vehicle to normal level
- lowering the vehicle at speeds above 75 mph (120 km/h) to save energy:
 - by approx. -0.4 in (-10 mm) in **C** and **E**
 - by approx. -0.8 in (-20 mm) in **S**
- raising the vehicle to normal level at speeds below 50 mph (80 km/h)

Drive program :

- suspension setting for off-road

- at speeds below 31 mph (50 km/h): raises the vehicle by approx. + 1.2 in (+ 30 mm) to off-road level +1
- lowering the vehicle to normal level at speeds above 43 mph (70 km/h)
- below 31 mph (50 km/h): raises the vehicle to off-road level +1 again
- from 68 mph (110 km/h): switch to **C**

Individual suspension settings can be called up in drive program **1*** (→ page 197).

- ⓘ **Operation with a trailer or bicycle rack:** if transport equipment, such as a trailer or a bicycle rack, is attached to the trailer hitch and the electrical connection has been correctly established, the vehicle always remains at normal level in all drive programs with the exception of . In drive program , the vehicle lowers above speeds of approx. 19 mph (30 km/h) to normal level.

Setting the vehicle level

⚠ WARNING Risk of accident because vehicle level is too high

Driving characteristics may be impaired.

The vehicle can drift outwards, for example, when steering or cornering.

- ▶ Choose a vehicle level which is suited to the driving style and the road surface conditions.

⚠ WARNING Risk of entrapment from vehicle lowering

When lowering the vehicle, people could become trapped if their limbs are between the vehicle body and the tires or underneath the vehicle.

- ▶ Make sure no one is underneath the vehicle or in the immediate vicinity of the wheel arches when the vehicle is being lowered.

⚠ WARNING Risk of becoming trapped due to the vehicle lowering

Vehicles with AIRMATIC or level control: when you unload luggage or leave the vehicle, the vehicle first rises slightly and then returns to the set level shortly afterwards.

You or anyone else in the vicinity of the wheel arches or the underbody could thus become trapped.

The vehicle can also be lowered after being locked.

- ▶ When leaving the vehicle, make sure that nobody is in the vicinity of the wheel arches or the underbody.

! NOTE Damage due to vehicle lowering

Parts of the body could be damaged when the vehicle is lowered.

- ▶ Make sure that there are no obstacles such as curbs underneath or in the immediate vicinity of the body when the vehicle is being lowered.

Requirements

- The vehicle has been started.
- The vehicle is not moving faster than 31 mph (50 km/h).
- When the trailer socket is contacted (trailer/bicycle rack): the vehicle is not moving faster than 19 mph (30 km/h).

Multimedia system:



Raising the vehicle

- ▶ Select . The indicator lamp lights up continuously. The vehicle is raised to off-road level +1.

Your selection is saved. Off-road level+1 set remains stored even after the vehicle has been switched off.

The vehicle is lowered again in the following situations:

- When driving faster than 43 mph (70 km/h).

- When the trailer socket is contacted (trailer/ bicycle rack): the vehicle is moving faster than 19 mph (30 km/h).

GPS-based raising

If the function is activated, it is possible to save the vehicle position when the vehicle level is raised.

- ▶ Confirm the prompt.
The position of the vehicle is stored. When the previously stored position is reached again, a prompt appears in the Zero Layer as to whether the vehicle level should be raised again.

- ① Settings for GPS-based raising
- ① Zero Layer function (→ page 317)

Lowering the vehicle

- ▶ Select .
The indicator lamp goes out.
The vehicle is adjusted to the normal level.
- ① Use the normal level in trailer operation. Off-road-level driving is not permitted in trailer operation on public roads.

Rear view camera

Function of the rear view camera

The rear view camera is only an aid. It is not a substitute for your attention to the surroundings. Responsibility for safe maneuvering and parking remains with you. Make sure that there are no persons, animals, objects, etc. in the maneuvering area while maneuvering and parking.

- ① The area behind the vehicle is displayed as a mirror image, as in the inside rear view mirror.

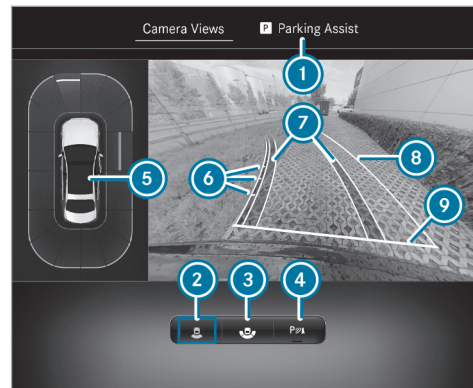

Camera Views menu (top view)

- ① Parking Assistance menu
- ② Rear view camera with top view
- ③ Wide-angle view
- ④ Activating/deactivating Parking Assist PARKTRONIC (→ page 284)
- ⑤ Warning display of Parking Assist PARKTRONIC (→ page 280)

- ⑥ Guide lines at a distance of approximately 1.6 ft (0.5 m), 3.3 ft (1.0 m), 5 ft (1.5 m) and 9.9 ft (3.0 m) from the rear area
- ⑦ Lane marking the course the tires will take with the current steering angle (dynamic)
- ⑧ Driven surface depending on the current steering angle (dynamic)
- ⑨ Guide line at a distance of approximately 1.0 ft (0.3 m) from the rear area
- ① When Active Parking Assist is active, lanes are displayed in green (→ page 284).



Wide-angle view

System limits

If the system is not ready for operation, the **System Inoperative** message appears in the central display.

The rear view camera will not function or will function only partially in the following situations:

- You are driving forwards at a speed greater than approximately 10 mph (16 km/h).
- The tailgate is open.
- The weather conditions are poor, e.g. heavy rain, snow, fog, storm or spray.
- The ambient light is poor, e.g. at night or if light is shining into the camera.
- The camera lens is obstructed, dirty or fogged up. Observe the notes on cleaning the rear view camera (→ page 385).
- The camera or rear of your vehicle is damaged. In this case, have the camera and its position and setting checked at a qualified specialist workshop.
- The detection range is limited by additional vehicle attachments at the rear, such as a license plate bracket or bicycle rack.

Also observe the information on vehicle sensors and cameras (→ page 225).

274 Driving and parking

- ❗ Do not use the rear view camera in these types of situations. You could otherwise injure others or collide with objects when parking the vehicle.
- ❗ The contrast of the display may be impaired by direct sunlight or by other light sources, e.g. when driving out of a garage. In this case, pay particular attention.
- ❗ Have the display repaired or replaced if, for example, pixel errors considerably restrict its use.

360° camera

Function of the 360° Camera

The 360° Camera is a system that consists of four cameras which cover the immediate surroundings of the vehicle. The cameras assist you when you are parking, for example, or at exits with reduced visibility.

The 360° Camera includes the following cameras and evaluates their images:

- Rear view camera
- Front camera

- Two side cameras in the outside mirrors

The cameras are only an aid and may show a distorted view of obstacles, show them incorrectly or not show them at all. They are not a substitute for your attention to the surroundings. Responsibility for safe maneuvering and parking remains with you. Make sure that there are no persons, animals, objects, etc. in the maneuvering area while maneuvering and parking.

Menu overview Camera Views

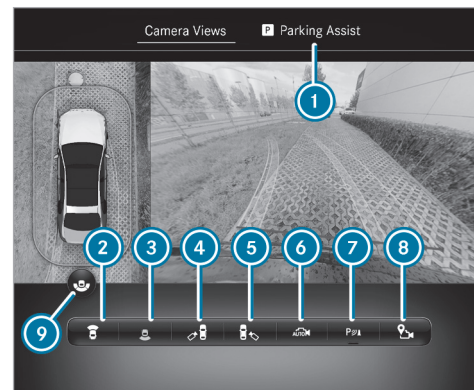

- ① Parking Assistance menu
- ② Top view with image from the front camera
- ③ Top view with image from the rear view camera
- ④ 3D view, left-hand side of the vehicle
- ⑤ 3D view, right-hand side of the vehicle
- ⑥ 3D auto view

- ⑦ Activating/deactivating Parking Assist PARKTRONIC (→ page 284)
- ⑧ To set the GPS activation point (→ page 280)
- ⑨ To switch between standard and wide-angle view
- ⓘ In all views, the Parking Assist PARKTRONIC warning display is shown (→ page 280).

Function of the guide lines

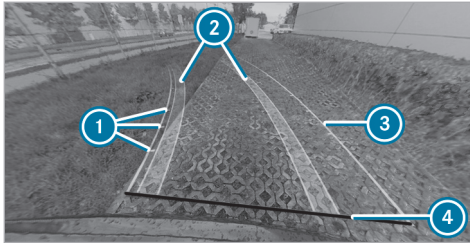

- ① Guide lines at a distance of approximately 1.6 ft (0.5 m), 3.3 ft (1.0 m), 5 ft (1.5 m) and 9.9 ft (3.0 m) from the rear area
- ② Lane marking the course the tires will take with the current steering angle (dynamic)

- ③ Driven surface depending on the current steering angle (dynamic)
- ④ Guide line at a distance of approximately 1.0 ft (0.3 m) from the rear area
- ⓘ When Active Parking Assist is active, lanes and guide lines are displayed in green instead of yellow (→ page 284).

Top view with image from the front or rear view camera

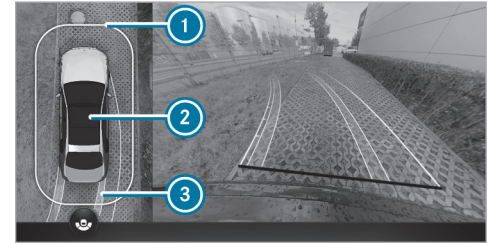

- ① Warning display of Parking Assist PARKTRONIC (→ page 280)
- ② Your vehicle from above
- ③ Lane indicating the route the vehicle will take at the current steering angle

3D view, left-/right-hand side of the vehicle

! **NOTE** Risk of accident due to objects being severely distorted in the display or not displayed at all

Due to the projection of the cameras, objects in the 3D views may be severely distorted when displayed or not displayed at all.

▶ Make sure that there are no persons, animals or objects etc. in the maneuvering area while maneuvering and parking.



1 Display of Parking Assist PARKTRONIC (→ page 280)

In the 3D view, left-/right-hand side of the vehicle, the virtual camera moves to the respective side of the vehicle. When you change the transmission position, the view is automatically adapted.

3D auto view

i The area behind the vehicle is **not** displayed as a mirror image as is usual in the 3D views.

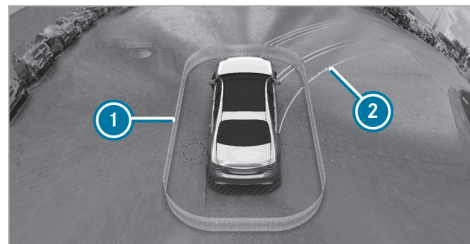

- 1** Display of Parking Assist PARKTRONIC (→ page 280)
- 2** Guide lines

In the 3D auto view, the virtual camera moves to the standard perspective, facing forward from the

rear above the roof. The view changes automatically when approaching obstacles.

If you touch the touchscreen, the view changes to 3D view with free rotation. You can turn, tilt and zoom the views by touch.

Wide-angle view



- 1** Display of Parking Assist PARKTRONIC (→ page 280)
- 2** To switch between standard and wide-angle view

Trailer view

i In trailer mode, the guide lines are shown at the level of the trailer hitch.

If you select trailer view and no trailer is coupled to the vehicle, the following display appears:

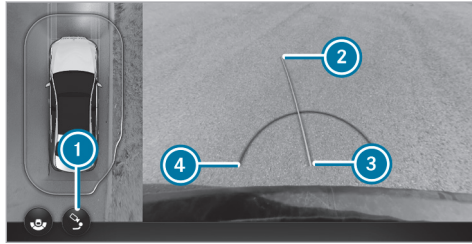

Trailer view: locating aid

- ① To switch between standard and trailer view
- ② Yellow locating aid
- ③ Ball head of the trailer hitch
- ④ Red guide line at a distance of approximately 1.0 ft (0.3 m) from the ball head of the trailer hitch

When the electrical connection is established between the vehicle and the trailer, the display changes to the side camera view.

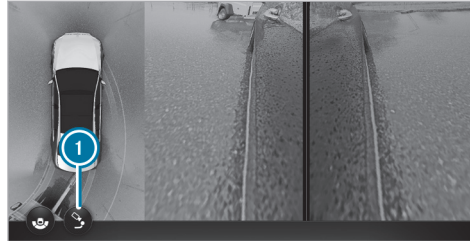

Trailer view: side view of the mirror cameras

- ① To switch between standard and trailer view

System limits

If the system is not ready for operation, the **System Inoperative** message appears in the central display.

The 360° Camera will not function or will only partially function in the following situations:

- You are driving forwards at a speed greater than approximately 10 mph (16 km/h).
- The doors are open.
- An outside mirror is not completely folded out.
- The tailgate is open.

- The weather conditions are poor, e.g. heavy rain, snow, fog, storm or spray.
 - The ambient light is poor, e.g. at night or if light is shining into the camera.
 - The camera lens is obstructed, dirty or fogged up.
 - If cameras or vehicle components in which the cameras are installed are damaged. In this event, have the cameras, their positions and their setting checked at a qualified specialist workshop.
- ⓘ Do not use the 360° Camera under such circumstances. You could otherwise injure others or collide with objects when parking the vehicle.

For technical reasons, the standard height of the vehicle may be altered if the vehicle is carrying a heavy load and can result in inaccuracies in the guide lines and in the display of the generated images.

The field of vision and other functions of the camera system may be restricted due to additional attachments on the vehicle (e.g. license plate bracket, bicycle rack).

- ① The contrast of the display may be impaired by abrupt, direct sunlight or by other light sources, e.g. when driving out of a garage. In this case, pay particular attention.
- ① Have the display repaired or replaced if, for example, pixel errors considerably restrict its use.

See the notes on cleaning the 360° Camera (→ page 385).

■ Off-road function of the 360° camera

The 360° camera can support you with different views when driving off-road.

The following views are available:

- Transparent hood
- Front view
- Rear view

To call up the function, call up the off-road menu in the multimedia system (→ page 341).

- ① Active Parking Assist and the maneuvering assistant functions are not available in drive program . PARKTRONIC Parking Assist is available in all driving programs when it is

switched on. Please also note the system limits of the respective functions.

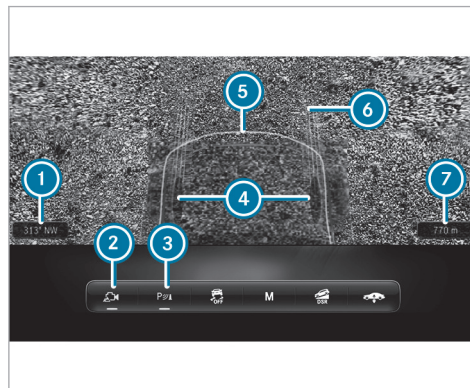

Transparent hood



Transparent hood displays (example)

- ① Point of the compass
- ② Switch camera view on/off
- ③ Activating/deactivating PARKTRONIC (→ page 280)

- ④ Position of the wheels
- ⑤ Area under the hood
- ⑥ Lane indicating the route the vehicle will take at the current steering angle
- ⑦ Altitude above sea level

If the off-road menu is open in the central display and the button  is switched on, the Transparent hood view is automatically displayed in gearbox position .

The Transparent hood view shows a virtual image of the area directly in front of the bumper, in front of the tires and under the hood. In addition, the current lane is displayed. The Transparent hood can assist you when driving in difficult terrain, e.g. on rocky or uneven ground.

The hatched area under the hood  was captured and recorded by the front camera. As soon as the area has been crossed by the vehicle, it is faded in. If the vehicle has not been moved for some time, the recorded area is displayed in gray-scale and faded out.

Front and rear view

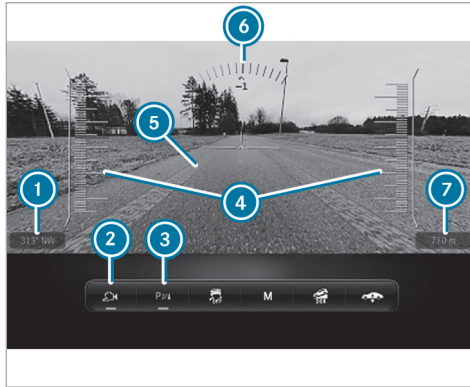

Display of front and rear view (example)

- ① Point of the compass
- ② Switch camera view on/off
- ③ Activating/deactivating PARKTRONIC (→ page 280)
- ④ Pitch display

- ⑤ Lane indicating the route the vehicle will take at the current steering angle
 - ⑥ Roll display
 - ⑦ Altitude above sea level
- ① Note that the area between the vehicle and up to approx. 40 in (1 m) in front of the vehicle is not displayed.
The slope and inclination indicators are shown only in the front view.

If the vehicle is traveling faster than approx. 5 mph (8 km/h) the view automatically changes from Transparent hood to Front View. If the vehicle is traveling at a speed greater than approximately 12 mph (20 km/h) - 19 mph (30 km/h) (depending on the drive program), the camera image will be closed.

When you engage reverse gear, the image from the rear view camera is automatically displayed.

System limits

The area under the hood may not be displayed correctly in the following situations:

- in the rain

- Driving in the dark
- When shadows fall on the area recorded by the camera

Observe the instructions on the function of the 360° camera as well as its system limits, otherwise you will not be able to recognize dangers (→ page 274).

Calling up the 360° camera views using the button

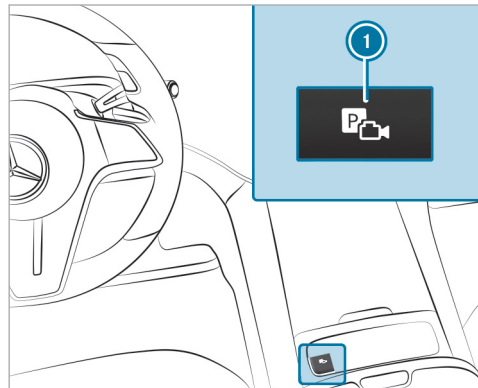

- ▶ Press button ①.
- ▶ Select the **Camera Views** menu.
- ▶ Select the desired view in the multimedia system (→ page 274).

Selecting a view for the 360° camera (reverse gear)

- ▶ Engage reverse gear.
- ▶ Select the desired view in the multimedia system (→ page 274).

360° Camera with GPS - managing activation positions

Multimedia system:

- ▶ ▶ Settings ▶ Assistance
- ▶ ▶ Camera

Renaming an activation position

- ① You can determine activation positions in the **Camera Views** menu. (→ page 274)
- ▶ Select for the desired activation position.
- ▶ Select **Edit**.
- ▶ Enter a name and confirm.
The activation position is saved under the new name.

Deleting an activation position

- ▶ Select for the desired activation position.
- ▶ Select **Delete Entry**.
- ▶ Confirm the prompt.
The activation position is deleted.

Opening the camera cover

Multimedia system:

- ▶ ▶ Settings ▶ Assistance
- ▶ ▶ Camera
- ▶ Select **Open Camera Cover**.

- ① The camera cover closes automatically after some time or after the vehicle is switched on or off.

Parking Assist PARKTRONIC

Function of Parking Assist PARKTRONIC

Parking Assist PARKTRONIC is an electronic parking assistance system which monitors the area surrounding your vehicle and shows you the distance between the vehicle and a detected obstacle visually and audibly.

The passive side impact protection also warns you of obstacles to the side. These must be detected beforehand by the sensors in the front or rear bumper while driving by them. If you steer in the direction of a detected obstacle and there is a risk of a lateral collision, a warning is issued. The passive side impact protection can be activated and deactivated via the multimedia system.

In order for front or rear obstacles to the side to be displayed, the vehicle must first travel a distance of at least half a vehicle length. Once the vehicle has traveled one vehicle length, obstacles on all sides can be shown.

Parking Assist PARKTRONIC is only an aid. It is not a substitute for your attention to the surroundings. Responsibility for safe maneuvering and parking remains with you. Make sure that there are no persons, animals, objects, etc. in the maneuvering area while maneuvering and parking in/exiting parking spaces.

Displays in the central display

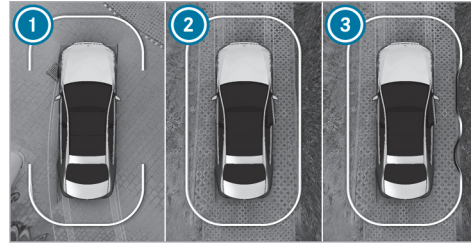

Vehicles with 360° Camera

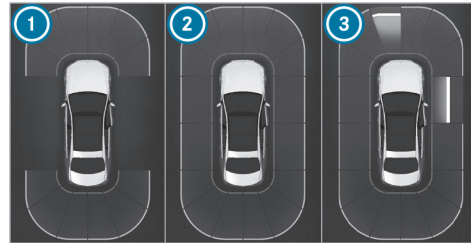

Vehicles with rear view camera

As soon as Parking Assist PARKTRONIC is ready for display, the respective areas of the display are shown in blue.

- ① Front and rear ready for display
- ② All sides ready for display
- ③ All sides ready for display and obstacle detected

The color of the display changes depending on the distance to the detected obstacle:

- **Blue:** > 3.3 ft (1 m) (no obstacles detected)
- **Yellow:** approx. 3.3 ft (1 m) - 2.2 ft (0.7 m)
- **Orange:** approx. 2.2 ft (0.7 m) - 1.2 ft (0.4 m)
- **Red:** <1.2 ft (0.4 m)

Vehicles with 360° Camera: the boundary line shifts dynamically depending on the position and distance of the obstacles detected.

Depending on the distance to the obstacle detected, an intermittent warning tone also sounds. You can set the timing of the warnings in the multimedia system. In the **Warn Early** setting, the system warns you from a distance of 3.3 ft (1 m), in the standard setting only from 1.2 ft (0.4 m).



Vehicles with 360° Camera



Vehicles with rear view camera

If you are not in the [Camera & Parking](#) menu and an obstacle in the vehicle path is detected, pop-up window ❶ appears in the central display if the following requirements are met:

- **Vehicles without Active Parking Assist:** when driving no faster than 8 mph (12 km/h).

- **Vehicles with Active Parking Assist:** when driving no faster than 11 mph (18 km/h).

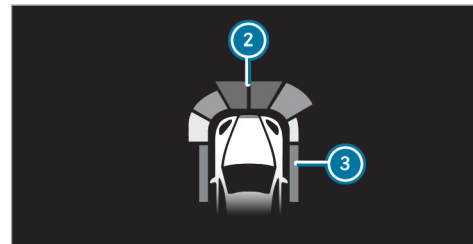

Optionally, obstacles detected by Parking Assist PARKTRONIC from a distance of approximately 3.3 ft (1.0 m) in front ❷ and 2.2 ft (0.7 m) on sides ❸ can also be displayed in the head-up display.

Vehicles with active ambient lighting and Parking Package with remote parking functions

When [Warning Support](#) is activated, the Parking Assist PARKTRONIC display is also accompanied by ambient lighting. If an obstacle is detected, the ambient lighting lights up in the same color as the display in the central display.

The ambient lighting which accompanies the Parking Assist PARKTRONIC display is only intended to accentuate the display in the central display and does not replace it.

More information on ambient lighting:
(→ page 155)

- ❗ A display message for the ambient lighting does not occur in the area of the driver's display or in the rear passenger compartment.
- ❗ Depending on the selected setting, other functions may supersede the ambient lighting effects of Parking Assist PARKTRONIC. In this case, the ambient lighting effects of Parking Assist PARKTRONIC do not occur.

System limits

Parking Assist PARKTRONIC does not necessarily take into account the following obstacles:

- Obstacles below the detection range, e.g. persons, animals or objects.
 - Obstacles above the detection range, e.g. overhanging loads, overhangs or loading ramps of trucks.
 - Pedestrians or animals approaching the vehicle from the side.
 - Objects placed next to the vehicle
- Obstacles on the sides are not shown in the following situations, for example:
- You park the vehicle and switch it off.
 - You open the doors.
- After the engine is restarted, obstacles must be detected again by driving past them before a new warning can be issued.
- Also observe the system limits of the following systems:
- Rear view camera (→ page 272)
 - 360° camera (→ page 274)
- Observe the information on vehicle sensors and cameras; the system otherwise cannot function properly (→ page 225).
- Vehicles with towbar:** If a transport device, e.g. trailer or bicycle carrier, is attached to the towbar and the electrical connection is correctly established, PARKTRONIC Parking Assist is deactivated for the rear zone.

Problems with Parking Assist PARKTRONIC

If the Parking Assist PARKTRONIC display lights up red for approximately three seconds then goes out, and the  symbol appears in the driver's display, the system may have been deactivated due to signal interference. Start the vehicle again and check if Parking Assist PARKTRONIC is working at a different location.

If a warning tone also sounds, it may be due to one of the following causes:

- **The sensors are dirty:** clean the sensors and observe the notes on care of vehicle parts (→ page 385).
- **Parking Assist PARKTRONIC has been deactivated due to a malfunction:** restart the vehicle. If the problem persists, consult a qualified specialist workshop.

■ Activating/deactivating Parking Assist PARKTRONIC

! **NOTE** Risk of an accident from objects at close range

Parking Assist PARKTRONIC may not detect certain objects at close range.

- ▶ When parking or maneuvering the vehicle, pay particular attention to any objects which are above or below the sensors, e.g. flower pots or drawbars. The vehicle or other objects could otherwise be damaged.

Requirements:

- The camera menu is open.
 - Or: Active Parking Assist is active.
 - Or: the PARKTRONIC pop-up window appears.
- ▶ Press **[PWA]** in the central display.

If the indicator lamp is lit, Parking Assist PARKTRONIC is active. If the indicator lamp does not light up or the symbol **[PWA^{OFF}]** is displayed, PARKTRONIC Parking Assist is not active.

i Parking Assist PARKTRONIC is automatically activated when the vehicle is started.

Alternatively, Parking Assist PARKTRONIC can be activated or deactivated in the quick access menu.

■ Setting the warning tones of Parking Assist PARKTRONIC

Multimedia system:

- ▶ **[Home]** ▶ Settings ▶ Assistance
- ▶ ▶ Parking

Adjusting warning tones

- ▶ Select **Set Warning Tones**.
- ▶ Set the desired level under **Volume** or **Tone Pitch**.

Activating/deactivating audio fadeout

- ▶ **Audio Fadeout** select and **Audio Fade for Warnings** switch on or off.

The volume of the currently playing media source is reduced during a Parking Assist PARKTRONIC warning tone.

or

- ▶ **Audio Fadeout** select and **Audio Fadeout When in R** switch on or off.

The volume of the currently playing media source is reduced when reverse gear is engaged.

Setting the time of the warnings

- ▶ Select **Time of Warning**.
- ▶ Activate or deactivate **Side Warning**.
- ▶ Set the desired warning time for **Front** or **Rear**.

Active Parking Assist

■ Function of Active Parking Assist

Active Parking Assist is an electronic parking assistance system that uses ultrasound with the assistance of the rear-view camera or the 360° camera. When you are driving forwards up to approximately 22 mph (35 km/h), the system will automatically measure parking spaces on both sides of the vehicle.

Active Parking Assist offers the following functions:



Vehicles with rear-view camera

- Parking in parking spaces parallel to the road
- Backing up into parking spaces perpendicular to the road

Vehicles with 360° camera

- Parking in parking spaces parallel to the road
- Parking in parking spaces perpendicular to the road (optionally either forwards or in reverse)
- Parking in parking spaces that can be detected as such only due to markings (e.g. at the roadside)
- Exiting a parking space parallel to the road
- Exiting a parking space perpendicular to the road (optionally either left or right)

Active Parking Assist is only an aid. It is not a substitute for your attention to the surroundings. The responsibility for safe maneuvering and parking remains with you. Make sure that no persons, animals, objects etc. are in the path of the vehicle.



If Active Parking Assist is available, the  message will appear on the driver's display. When the system detects parking spaces,  will appear.

The arrows show on which side of the road available parking spaces are located. These will then be shown on the central display.

When Active Parking Assist is activated, the turn signal indicators will be activated based on the calculated path of your vehicle. When you are entering or exiting a parking space, the procedure will be assisted by acceleration, braking, steering and gear changes.

To start the parking procedure, press the  button (→ page 286).

Active Parking Assist will be canceled in the following situations:

- You deactivate Parking Assist PARKTRONIC.
- You press the  button again.
- You begin steering.
- You engage park position .
- ESP® intervenes.
- You open the driver's door.

System limits

In drive program  or if the exterior lighting is malfunctioning, Active Parking Assist will not be available.

Also observe the system limits of the following systems:

- Rear-view camera (→ page 272)
- 360° camera (→ page 274)

Objects that are above or below the detection range of Active Parking Assist, e.g. protruding loads, overhangs or loading ramps of trucks or boundaries of parking spaces, are not detected during measurement of the parking space. These will also then not be taken into account when the parking procedure is calculated. In some circumstances, Active Parking Assist may therefore guide you into the parking space prematurely or brake too late.

Certain ambient conditions, such as snowfall or heavy rain, may lead to a parking space being measured inaccurately. Parking spaces that are partially occupied by trailer drawbars may not be identified as such or be measured incorrectly. Use

Active Parking Assist only on level, high-grip ground.

⚠ WARNING Risk of accident due to objects located above or below the detection range of Active Parking Assist

If there are objects above or below the detection range, the following situations may arise:

- Active Parking Assist may steer too early.
- The vehicle may not stop in front of these objects.

There is a danger of collision!

- ▶ In these situations, do not use Active Parking Assist.

Active Parking Assist can also display unsuitable parking spaces, e.g. parking spaces in which parking is not permitted or parking spaces on unsuitable surfaces.

Do not use Active Parking Assist in the following situations:

- In extreme weather conditions such as ice, snow or heavy rain.

- When transporting a load that protrudes beyond the vehicle.
- If the parking space is on a steep downhill or uphill gradient.
- When snow chains are installed.
- When a trailer or bicycle rack is attached.
- Directly after a tire change or when spare tires are installed.
- If the tire pressure is too low or too high.
- If the suspension is out of alignment, e.g. after bottoming out on a curb.
- On steep inclines of more than approximately 15%.

■ Parking with Active Parking Assist

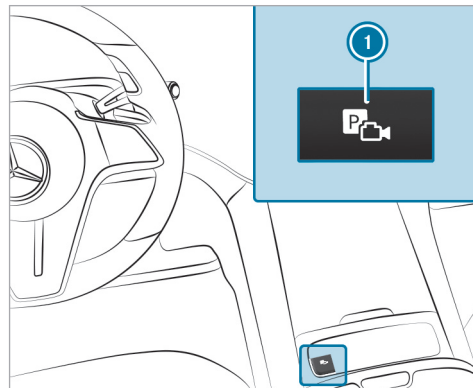

i Depending on the vehicle's equipment, button **1** may also be located in a different place in the center console.

- ▶ Press button **1**.

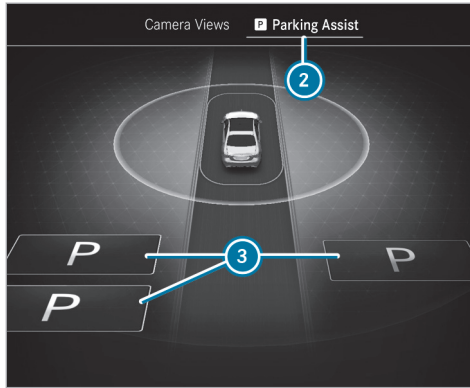

- ▶ Select **Parking Assistance** menu ②.

Parking spaces ③ detected by the system are shown on the central display.

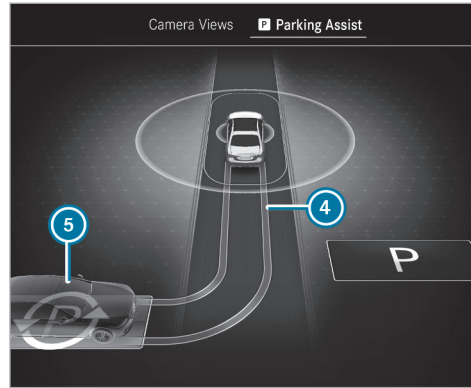

When the vehicle is stationary, indicated vehicle path ④ into currently selected parking space ⑤ also appears.

- ▶ If a parking space is displayed: stop the vehicle.
- ▶ If necessary, select another parking space.

- ▶ **Vehicles with 360° camera:** to change the parking direction, tap the selected parking space again.
- ▶ **To start the parking procedure:** press button ① again. The vehicle drives into the selected parking space.

The turn signal indicator is switched on automatically when the parking procedure begins. You are responsible for selecting the turn signal indicator in accordance with the traffic conditions. If necessary, select the turn signal indicator accordingly.

⚠ WARNING Risk of accident due to vehicle swinging out while parking or pulling out of a parking space

While parking or exiting a parking space, the vehicle swings out and can drive onto areas of the oncoming lane.

This could cause you to collide with objects or other road users.

- ▶ Pay attention to objects and other road users.

- ▶ Where necessary, stop the vehicle or cancel the parking procedure with Active Parking Assist.

On completion of the parking procedure, the **Active Parking Assist Finished** display message appears.

- ▶ Secure the vehicle against rolling away. When required by legal stipulations or local conditions: turn the wheels towards the curb.
- ⓘ You can stop the vehicle and change the transmission position during the parking procedure. The system then calculates a new vehicle path. If no new vehicle path is available, the transmission position can be changed again, or the process can be canceled.

Immediate parking via the **Camera Views** menu



- ▶ Select the **Camera Views** menu.
- ▶ When the vehicle is stationary and in transmission position **[R]**, and symbol **6** appears in the camera image: press button **1** again. The parking procedure is initiated for the detected parking space.

- ⓘ The parking space and parking direction cannot be changed in immediate parking.

Exiting a parking space with **Active Parking Assist**

Requirements

- The vehicle is equipped with a 360° camera.

- The vehicle has been parked with Active Parking Assist.

- ▶ Start the vehicle.
- ▶ Press button **1**.

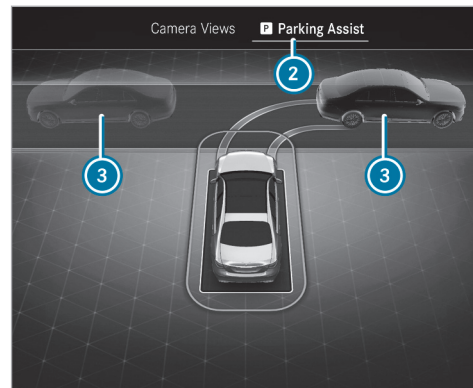

- ▶ Select **Parking Assistance 2** menu.
- ▶ If necessary, change direction of exit **3**.

- ▶ **To start exiting the parking space:** press button  again.
- ▶ If necessary, change the transmission position. Observe any messages displayed on the driver's display and central display. The vehicle moves out of the parking space.

The turn signal indicator is automatically switched on when exiting a parking space begins and switched off when it is completed. You are responsible for selecting the turn signal indicator in accordance with the traffic conditions. If necessary, select the turn signal indicator accordingly.

After the parking space has been exited, a warning tone and the  **Active Parking Assist Finished: Take Control of Vehicle** message prompt you to take control of the vehicle. You have to accelerate, brake, steer and change gear yourself again.

If you do not react to the prompt to take control of the vehicle, the system will brake the vehicle to a standstill.

■ Pausing Active Parking Assist

You can interrupt the parking or exiting procedure of Active Parking Assist by performing one of the following actions, forexample:

- ▶ Depress the brake pedal.
- ▶ Open the front passenger door, a rear door or the tailgate.
- ▶ Apply the electric parking brake or activate the HOLD function.
- ▶ **To resume the parking or exiting procedure:** gently depress the accelerator pedal.

- ⓘ If the electric parking brake was applied before Active Parking Assist was activated, depress the accelerator pedal lightly to start the parking or exiting procedure.

Check the area around your vehicle again before resuming a paused parking procedure. Make sure once more that there are no persons, animals or objects in the vehicle's path. Also observe the system limitations of Active Parking Assist.

■ Automatic braking function of Active Parking Assist

Persons or objects detected in the vehicle's path could cause the vehicle to brake sharply and interrupt the parking or exiting procedure. The vehicle will then be held at a standstill. If you depress the accelerator pedal, the parking or exiting procedure is resumed.

Check the area around your vehicle again before resuming the parking or exiting procedure. Make sure that persons, animals or objects are no longer in the vehicle's path. Also observe the system limitations of Active Parking Assist.

Remote Parking Assist

■ Function of Remote Parking Assist

- ⓘ Remote Parking Assist is an additional function of Active Parking Assist. Comply with local traffic laws and regulations when using Remote Parking Assist on public roads. If it is required to turn the wheels toward the curb, you cannot use Remote Parking Assist.

Please note that you can use Remote Parking Assist only if you have a valid driving license and are in a fit state to drive.

Remote Parking Assist parks your vehicle or exits the parking space while you are outside of your vehicle. You can monitor the maneuvering and parking procedure on your mobile phone.

With Remote Parking Assist, you can carry out all the parking procedures of Active Parking Assist. You can also position the vehicle directly in front of a garage or a driveway entrance and then use Remote Parking Assist to enter or exit a parking space.

Remote Parking Assist manages pulling away, braking and steering. While Remote Parking Assist is active, the vehicle is locked.

Remote Parking Assist is only an aid. It is not a substitute for your attention to the surroundings. Responsibility for safe maneuvering and parking remains with you. Interrupt or terminate the parking procedure if necessary. Make sure that no persons, animals, objects, etc. are in the maneuvering range. Make sure to also pay attention to other vehicles.

System limits

If the system detects a malfunction or a system limit during the maneuvering or parking procedure, the procedure will be canceled:

- The vehicle is brought to a standstill.
- Transmission position **P** is selected and the electric parking brake is applied automatically.
- The vehicle is switched off.
- The vehicle remains locked.

If the parking maneuver is canceled, a corresponding message is displayed on the mobile phone.

Depending on the situation, you can then take control of the procedure, maneuver the vehicle back to the starting position or manually take control of the vehicle.

The system limits of Active Parking Assist apply (→ page 284).

Certain environmental conditions, such as snowfall or heavy rain, may lead to a parking space being measured inaccurately or to connection problems with the mobile phone. Only use Remote Parking Assist on level, high-grip ground.

During the parking procedure, you should not stand more than approx. 10 ft (3.0 m) away from the vehicle. At greater distances, the procedure will be interrupted and a corresponding message will be displayed on the mobile phone. If you move closer to the vehicle, you will be able to continue the procedure.

■ Operating Remote Parking Assist

Requirements

For the Remote Parking Assist function, you require:

- a Mercedes me user account
- the current Remote Parking Assist App for your vehicle type
- a mobile phone

i A list of compatible phones can be found at: <https://www.mercedes-benz-mobile.com/>

The following operating systems are supported:

- Android™
- Apple® iOS

⚠ WARNING Danger due to insufficient view of the vehicle surroundings

If you maneuver, park or exit a parking space with the vehicle using Remote Parking Assist, observe the following:

- ▶ Make sure that you have the best view possible of the vehicle and the vehicle's surroundings.
- ▶ Make sure that no persons, animals or objects are in the path of your vehicle.
- ▶ Make sure that you maintain a suitable distance to the vehicle and that neither you nor other road users could be endangered.
- ▶ Be aware of the vehicle's surroundings at all times and identify possible dangers.
- ▶ If necessary, cancel the parking procedure.

No persons or pets are permitted to remain in the vehicle during the parking procedure. Observe the system limits at all times. If necessary, cancel the

parking procedure. Always ensure that vehicle access by other road users is maintained.

- ▶ Activate the "Remote Parking Assist" service e.g. via the Mercedes me homepage.
- ▶ Authorize the mobile phone using the Remote Parking Assist App in the vehicle (→ page 293).

Selecting the parking maneuver in advance while inside the vehicle

- ▶ Stop the vehicle and select transmission position **P**.

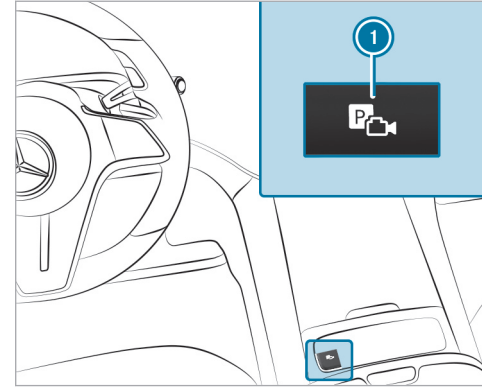

- ⓘ Depending on the vehicle's equipment, button ① may also be located at a different position in the center console.

- ▶ Press button ①.

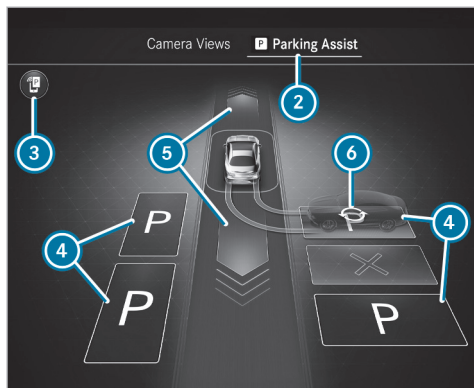

- ▶ Select **2** **Parking Assistance** menu.
- ▶ For further information on Remote Parking Assist: select **3**.
- ▶ If necessary, select another parking space or select **5** to drive straight ahead into a garage, for example.
- ▶ If necessary, change parking direction **6**.

- i** Alternatively, you can begin parking with Active Parking Assist (→ page 286) and continue with the Remote Parking Assist from any vehicle position. To do this, stop the parking process and adjust the gearbox setting **P**.

- ▶ Switch off the vehicle and exit it with the key.

Starting the parking procedure without selecting in advance

- ▶ Stop the vehicle and select transmission position **P**.
- ▶ Switch off the vehicle and exit it with the key.

Starting the parking procedure while outside the vehicle

- ▶ Unlock the vehicle.

Carrying out a parking procedure with Remote Parking Assist

- i** Keep the vehicle key with you during the parking procedure. You can cancel the parking procedure and bring the vehicle to a standstill by pressing a button on the key.
- i** On completion of the parking procedure, the vehicle is locked.

If you have started the parking procedure as described above, the vehicle is ready to connect to your mobile phone for a limited time.

- ▶ Start the Remote Parking Assist App on the mobile phone and connect to the vehicle.
- ▶ Follow the instructions of the Remote Parking Assist App.

- i** The turn signal indicator is automatically switched on when starting parking and switched off when it is completed.
- i** If the connection between the vehicle and the mobile phone is interrupted while a parking maneuver is being performed, the maneuver can be continued if the connection is re-established within a short time.

⚠ WARNING Risk of accident due to vehicle swinging out while parking or pulling out of a parking space

While parking or pulling out of a parking space, the vehicle swings out and can drive onto areas of the oncoming lane.

This could cause you to collide with objects or other road users.

- ▶ Pay attention to objects and other road users.
- ▶ Where necessary, stop the vehicle or cancel the parking procedure with Remote Parking Assist.

- ▶ After ending the parking procedure, ensure that all vehicle doors, windows and the trunk are closed. Secure the vehicle against rolling away.

Canceling the parking procedure

You can cancel the parking procedure of Remote Parking Assist at any time and bring the vehicle to a standstill.

- ▶ Cancel the parking procedure in the Remote Parking Assist App.
- or
- ▶ Press a button on the vehicle key.
- or
- ▶ Pull a door handle.

Authorizing/de-authorizing a mobile phone for Remote Parking Assist

Multimedia system:

- ▶  ▶ Settings ▶ Assistance
- ▶ Parking ▶ Remote Parking Assist

Authorizing a new mobile phone

In order to be able to use the Remote Parking Assist function, you must authorize your mobile phone. You can authorize up to ten mobile phones.

- ▶ Select [Remote Parking Assist](#).
- ▶ Select [Authorize a New Device](#) in the window that opens.
Remote Parking Assist is ready to connect.
- ▶ Start the Remote Parking Assist App and additionally start the authorization process.
A connection prompt is displayed.
- ▶ Scan the QR code on the central display.
The mobile phone is authorized.

De-authorizing mobile phones

- ▶ Select [Remote Parking Assist](#).

- ▶ In the window that opens, select the device to be de-authorized.

- ▶ **To de-authorize a mobile phone:** select a mobile phone and confirm with **Yes**.
The mobile phone is deleted from the device list.
- ▶ **To de-authorize all mobile phones:** select **Deauthorize All Devices** and confirm with **Yes**.
All mobile phones are deleted from the device list.

Maneuvering assistance

Function of Drive Away Assist

Drive Away Assist can reduce the severity of an impact when you are pulling away. If the system detects an obstacle in the direction of travel, the vehicle's speed will briefly be reduced to approximately 1 mph (2 km/h).

A risk of collision may occur in the following situations, for example:

- If the driver mixes up the accelerator and brake pedals.
- If the driver engages an incorrect gear.

- If the driver depresses the accelerator pedal with too much force.

Drive Away Assist will be active in the following circumstances:

- If the vehicle was stationary and the transmission position was changed to **R** or **D**.
- If the vehicle has rolled less than approximately 3.3 ft (1.0 m) since being at a standstill.
- If the detected obstacle is less than approximately 3.3 ft (1.0 m) away.

The **Drive-away Assist** can be deactivated or activated on the **Maneuvering Assistance** menu (→ page 296).

If a critical situation is detected, the following symbol will appear in red in the selected view on the **Camera & Parking** menu:



- If Drive Away Assist is not available, the same symbol will appear in grey. If the **Camera &**

Parking menu is not opened on the central display, the symbol and pop-up of Parking Assist PARKTRONIC will both appear.

Drive Away Assist is only an aid. It is not a substitute for your attention to the surroundings. The responsibility for safe maneuvering and parking remains with you. Make sure that no persons, animals, objects etc. are in the path of the vehicle.

⚠ WARNING Risk of accident caused by limited detection performance of Drive Away Assist

Drive Away Assist cannot always clearly identify objects and traffic situations.

- ▶ Always pay careful attention to the traffic situation; do not rely on Drive Away Assist alone.
- ▶ Be prepared to brake or swerve as necessary, provided the traffic situation permits and that it is safe to take evasive action.

System limits

Drive Away Assist is not available in drive program .

The system limits of Active Parking Assist apply (→ page 284).

On uphill gradients, the performance of Drive Away Assist will be restricted.

If transport equipment, e.g. a trailer or bicycle rack, is attached to the trailer hitch and the electrical connection is correctly established, Drive Away Assist will not be available when you are reversing.

Function of cross traffic warning

The cross traffic warning can warn you of crossing traffic when you are exiting a parking space. The radar sensors in the bumper also monitor the area adjacent to the vehicle.

The cross traffic warning is active under the following conditions:

- **Warning for Cross Traffic, Rear:** the vehicle is driving in reverse at a speed slower than approx. 6 mph (10 km/h).

- **Warning for Cross Traffic, Front:** the vehicle is driving forwards at a speed slower than approx. 6 mph (10 km/h) and the camera image is shown in the central display (→ page 280).

The **Warning for Cross Traffic, Front** can be deactivated or activated in the **Maneuvering Assistance** menu (→ page 296).

If a critical situation is detected, the following symbol appears in red in the selected view in the **Camera & Parking** menu:



Warning for Cross Traffic, Rear

- The vehicle can be braked automatically when crossing traffic is detected.
- If the **Camera & Parking** menu is not open and a critical situation is detected, a warning appears in the central display together with the PARKTRONIC Parking Assist pop-up.

Warning for Cross Traffic, Front

- If Active Parking Assist is active, the vehicle can be braked automatically when crossing traffic is detected.
- If Active Parking Assist is not active but the menu **Camera & Parking** is open, a warning appears.
- If the **Camera & Parking** menu is not open, the system cannot react to crossing traffic.

The cross traffic warning is only an aid and not a substitute for your attention to the surroundings. Responsibility for safe maneuvering and parking remains with you. Make sure that no persons, animals, objects, etc. are in the maneuvering range.

⚠ WARNING Risk of accident caused by limited detection performance of the cross traffic warning

The cross traffic warning cannot always clearly identify objects and traffic situations.

- ▶ Always pay careful attention to the traffic situation; do not rely on the cross traffic warning alone.

- ▶ Be prepared to brake or swerve as necessary, provided the traffic situation permits and that it is safe to take evasive action.

System limits

- ⓘ If the cross traffic warning is not available, the symbol appears in gray.

In the drive program, the warning for cross traffic is not available.

The system limits of Active Parking Assist apply (→ page 284).

If the radar sensors are obstructed by vehicles or other objects, detection is not possible.

In the following situations, the cross traffic warning is not available:

- on inclines
- **Warning for Cross Traffic, Rear:** if a transport device, e.g. trailer or bicycle carrier, is attached to the hitch and the electrical connection is correctly established.

■ Maneuvering brake function

The maneuvering brake function can prevent collisions with pedestrians when the vehicle is backing up at slow speeds. If the rear view camera detects a person in the vehicle's path, the vehicle can be braked to a standstill.

The maneuvering brake function can intervene under the following conditions:

- The vehicle is backing up at a speed slower than 6 mph (10 km/h).
- The camera image is shown on the central display (→ page 280).

Depending on the country, you can activate and deactivate the maneuvering brake function in the **Maneuvering Assistance** menu (→ page 296).

If the maneuvering brake function is triggered, the following symbol appears in red in the selected view in the **Camera & Parking** menu:



i If the maneuvering brake function is not available, the same symbol appears in gray.

The maneuvering brake function is only an aid. It is not a substitute for your attention to the surroundings. The responsibility for safe maneuvering and parking remains with you. Make sure that no persons, animals or objects etc. are in the vehicle's path.

⚠ WARNING Risk of accident caused by limited detection by the maneuvering brake function

The maneuvering brake function cannot always clearly detect people. Other obstacles are not detected by the function.

In these cases, the function may brake unnecessarily or not brake at all.

- ▶ Always pay careful attention to the traffic situation; do not rely on the maneuvering brake function alone.
- ▶ Be ready to brake.

System limits

In drive program , the maneuvering brake function is not available.

Observe the system limits of the following functions:

- Active Parking Assist (→ page 284)
- 360° camera (→ page 274)
- Rear view camera (→ page 272)

The maneuvering brake function is not available in the following situations:

- On inclines
- If transport equipment, for example a trailer or bicycle rack, is attached to the trailer hitch and the electrical connection has been correctly established.



■ Activating/deactivating maneuvering assistant

Multimedia system:

 **▶ Settings ▶ Assistance**
▶ Parking

i This function is an on-demand feature (→ page 29).

 Activating/deactivating the maneuvering assistant function is not available in all countries.

-  Select **Maneuvering Assistance**.
-  Activate or deactivate the desired maneuvering assistance.

Memory Parking Assist

Function of Memory Parking Assist

Memory Parking Assist can park your vehicle using a previously stored parking space. You can store parking procedures with a total distance of up to 550 yds (500 m) (110 yds (100 m) per parking or exiting procedure).

During parking or exiting, the system can travel a previously stored path of up to approximately 110 yds (100 m) to or out of the desired parking space, for example, from the driveway entrance into the garage.

Within a radius of approx. 165 yds (150 m), only one parking or exiting procedure can be recorded.

Use Memory Parking Assist only on private property. Use on public roads, e. g. in public parking spaces, is not permitted.

Memory Parking Assist is only an aid. It is not a substitute for your attention to the surroundings. Responsibility for safe maneuvering and parking remains with you. Make sure that no persons, animals, objects, etc. are in the maneuvering range.

System limits

Observe the system limitations of Active Parking Assist (→ page 284).

 **WARNING** Risk of accident due to objects located above or below the detection range of Memory Parking Assist

If there are objects above or below the detection range, the following situations may arise:

- Memory Parking Assist may steer too early.
- The vehicle may not stop in front of these objects.

This result in a collision.

 In these situations, do not use Memory Parking Assist.

Objects located above or below the detection range of Memory Parking Assist may not be detected during the parking procedure.

Drawbars of parked trailers, among other objects, that protrude into the parking space may not be detected.

Do not use Memory Parking Assist in the following situations, for example:

- In extreme weather conditions such as ice, packed snow or in heavy rain.
- When transporting a load that protrudes beyond the vehicle.
- If the parking space is on a steep downhill or uphill gradient.
- When snow chains are installed.

Recording a parking procedure using Memory Parking Assist

Requirements

- The entire route is, for example, within your own property and not on public roads.
- The system needs reference points in the surroundings to orient itself, such as fences, walls or trees. Therefore, after starting the vehicle, a certain distance must first be driven. If not enough reference points are detected in the surrounding area, no new route can be recorded.

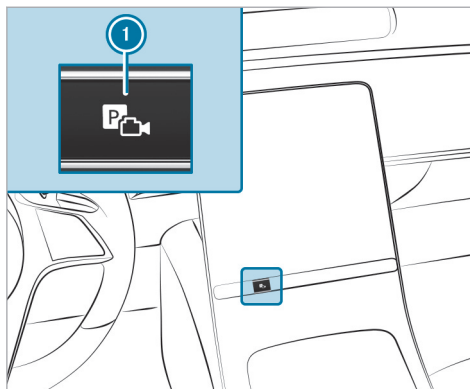

- ▶ Press button ①. The **Camera & Parking** view opens in the central display.



- ▶ Select ② **Memory Parking Assist** menu.
- ▶ Brake the vehicle to a standstill at the desired starting point of the assisted parking procedure, e.g. a driveway entrance.
- ▶ **To start recording:** tap on ③.
- ⓘ If not all conditions for a recording are met, symbol ③ is grayed out.

- ▶ Park the vehicle in the desired parking space. Do not exceed 5 mph (8 km/h).
- ▶ **To stop recording:** Stop the vehicle and tap on **3** again. The recording is stored.
- ❶ In the Memory Parking Assist settings you can delete and rename stored parking procedures.

▶ Parking with Memory Parking Assist

Requirements

- A parking procedure has been recorded.
- ▶ Press button **1**. The **Camera & Parking** view opens in the central display.



- ▶ Select **Memory Parking Assist 2** menu.
- ▶ Brake the vehicle to a standstill at the starting point of the stored parking procedure.
- ▶ **To start the parking procedure:** press **▶**.
- ▶ Select the stored parking procedure from the list.

- ▶ Follow the instructions on the central display. The vehicle drives into the selected parking space.
- ❶ The turn signal indicator is not switched on automatically. You are responsible for selecting the turn signal indicator in accordance with the traffic conditions.
- ▶ After completion of the parking procedure, safeguard the vehicle against rolling away.

▶ Exiting a parking space with Memory Parking Assist

Requirements

- The exiting procedure was recorded together with the respective parking procedure and stored separately within one driving cycle.
- The vehicle was parked using Memory Parking Assist.
- ▶ Press button **1**. The **Camera & Parking** view opens in the central display.
- ▶ Select **Memory Parking Assist 2** menu.

Starting the exiting procedure

- ▶ Press .
 - ▶ Confirm the saved exiting procedure.
 - ▶ Follow the instructions on the central display. The vehicle drives the recorded route.
- i** The turn signal indicator is not switched on automatically. You are responsible for selecting the turn signal indicator in accordance with the traffic conditions.
- ▶ Take control of the vehicle after the exiting procedure has been completed.

Setting Memory Parking Assist

Multimedia system:

-  ▶ Settings ▶ Assistance
- ▶ Parking ▶ Memory Parking Assist

Renaming a recording

- ▶ Select **Memory Parking Assist**.
- ▶ Select  next to the desired recording.
- ▶ Enter a name and confirm with **OK**.

Deleting a recording

- ▶ Select **Memory Parking Assist**.
- ▶ Select  next to the desired recording. The selected recording is deleted.

Deleting all recordings

- ▶ Select **Memory Parking Assist**.
 - ▶ Select **Delete All Lanes**.
- i** Alternatively, you can delete all data in Memory Parking Assist by resetting the multimedia system (→ page 336).

Trailer Maneuvering Assist

Function of Trailer Maneuvering Assist

- i** This function is an on-demand feature (→ page 29).

⚠ WARNING Risk of accident due to unsuitable trailers

Trailers with a steered axle or a fifth wheel cannot be used with Trailer Maneuvering Assist.

Due to this, the trailer cannot be maneuvered in the desired direction and you can cause a collision or the trailer can rollover.

- ▶ Only use Trailer Maneuvering Assist with trailers with fixed drawbars and axles.

⚠ WARNING Risk of accidents due to unsuitable hitching devices

Trailer hitches without a ball head, such as a Hensley hitch or a pintle hitch, as well as any hitch adapters or multiple hitch ball mounts, **cannot** be guided by Trailer Maneuvering Assist.

This will prevent the trailer from maneuvering in the desired direction and you may cause a collision or the trailer may roll over.

- ▶ Use Trailer Maneuvering Assist only with a trailer hitch with a ball head.
- ▶ Use Trailer Maneuvering Assist only with a trailer hitch without additional attachments, such as a weight distribution system or sway control.

- ▶ Use Trailer Maneuvering Assist only with a trailer with a drawbar that has no additional attachments or superstructures.
- ▶ Use Trailer Maneuvering Assist only with a hitch ball mount. The use of an additional hitch adapter or hitch ball mount is not permitted.

⚠ WARNING Danger of accident due to incorrect taught values for the ball head position

If after changing the trailer, ball neck or changing the ball head position the values for the ball head position are **not** reset and a calibration drive is carried out again, Trailer Maneuvering Assist will not function properly. This will prevent the trailer from maneuvering in the desired direction and you may cause a collision.

- ▶ After changing the trailer, the ball neck or the ball head position, do not use Trailer Maneuvering Assist without carrying out a calibration drive again.

- ▶ After changing the trailer, the ball neck or the ball head position, reset the taught-in values.
- ▶ Then, carry out a calibration drive to teach in the values of the new ball head position.

Information on resetting the taught-in values for the ball head position and on the calibration drive (→ page 307).

! NOTE Damage due to overhanging loads in front or drawbar installations

The vehicle and the trailer may be damaged during maneuvering due to overhanging loads at the front of the trailer or drawbar installations.

- ▶ Pay attention to overhanging loads or drawbar installations while maneuvering.

Trailer Maneuvering Assist will assist you when you are backing up with a trailer. Using the rear-view camera, it monitors the articulation angle between the vehicle and trailer and adjusts it to a

specified value. Trailer Maneuvering Assist will also limit your speed.

For Trailer Maneuvering Assist to function properly, a calibration drive must be carried out for the trailer and ball neck used and if the ball head position is changed. The current ball head position will be taught in during the calibration drive (→ page 307).

Trailer Maneuvering Assist is only an aid. It is not a substitute for your attention to the surroundings. The responsibility for safe maneuvering and parking remains with you. Make sure that there are no persons, animals or objects in the maneuvering area while you are maneuvering and parking in / exiting parking spaces.

You can either enter the articulation angle value directly via the multimedia system, or use a straightening maneuver or the 90° maneuver. When you carry out a straightening maneuver, the system will calculate the articulation angle automatically and align the vehicle/trailer combination with the trailer's current direction.

Observe the notes on trailer operation (→ page 303).

System limits

Observe the system limits of the following functions:

- Active Parking Assist (→ page 284)
- 360° camera (→ page 274)
- Rear-view camera (→ page 272)

The system may be impaired or may not function in the following situations:

- The gradient is greater than approximately 15%.
- The height of the ball head above level ground is less than 13.8 in (0.35 m) or more than 21.6 in (0.55 m)

Using Trailer Maneuvering Assist

Requirements

- The vehicle has been started and is stationary.
- A trailer is selected on the **Vehicle** menu (→ page 307).
- A trailer has been detected.

- A calibration drive was performed with the trailer and ball neck used and the current ball head position (→ page 307).
- A drive in a straight line was performed to calibrate Trailer Maneuvering Assist in compliance with the instructions on the central display (→ page 307).
- The gradient is less than approximately 15%.
- The tailgate is closed.
- The electric parking brake is not applied.
- The driver's seat belt is fastened.

Using Trailer Maneuvering Assist

- ① To ensure that Trailer Maneuvering Assist works properly, the taught-in values for each ball head position must be reset after the trailer, the ball neck and ball head position have been changed. A calibration drive must then be performed again. Information on resetting and the calibration drive (→ page 307).

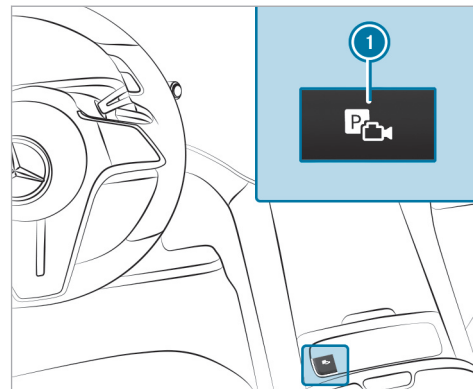

- ▶ Engage reverse gear **R**.
- ▶ Press button ①.
The camera image is shown on the central display.

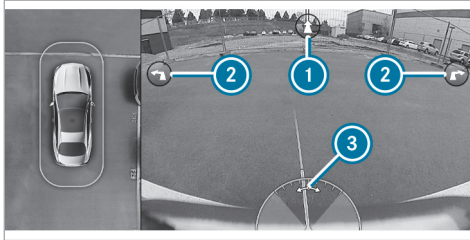

i The picture is an example only and is shown without trailer.

You can select various maneuvers on the Trailer Maneuvering Assist menu. The maneuvers available depend on the current articulation angle and length of the trailer.

▶ To adjust the articulation angle: select **3**. In the central display, swipe the entire area of the camera image to the left or right to change the bend angle.

or

▶ To activate the straightening maneuver: select **1**. The system will calculate the articulation angle in such a way that the direction of the trailer at the time of activation is maintained. There will be a short countersteering movement by the trailer while the vehicle is being reversed, which will then guide it back to the desired line. In this way, the vehicle will be aligned in a straight line with the trailer and, at the same time, the direction of the trailer will be maintained.

or

▶ To activate the 90° maneuver:

- Align the vehicle in the same direction (line) as the trailer.
- Select (left or right) **2**.

The system will calculate the articulation angle in such a way that the trailer can be maneuvered into a space perpendicular to the vehicle using the smallest possible angle. After the maneuver, the vehicle will be aligned again in the direction of the trailer.

▶ Accelerate and brake as required.

- i** The maximum articulation angle depends on the length of the trailer. This is calculated by the system by driving the vehicle forwards, including cornering. Before the length of the trailer has been calculated, the maximum articulation angle is approximately 23°. The longer the trailer is, the higher the maximum articulation angle (approximately 60°).
- i** Pay attention to your surroundings and be ready to brake at all times.

Trailer hitch

Notes on trailer operation

! **NOTE** Mercedes-AMG vehicles

▶ Observe the notes in the Supplement. You could otherwise fail to recognize dangers.

! **WARNING** Risk of accident due to unsuitable ball neck

If you install an unsuitable ball neck, the trailer hitch and the rear axle may be overloaded.

This can significantly impair the driving characteristics and the trailer may become loose. There is a risk of fatal injury.

- ▶ Only install a ball neck that complies with the permissible dimensions and is designed for the requirements of trailer operation.
- ▶ Do not modify the ball neck or the trailer hitch.

The values approved by the manufacturer can be found on the identification plates and in the "Technical data" section under "Trailer hitch" for the towing vehicle (→ page 449).

⚠ WARNING Risk of accident due to vehicle/trailer combination swerving

If you drive too fast in trailer operation, the vehicle/trailer combination may start to swerve.

This could cause you to lose control of the vehicle/trailer combination. The vehicle/trailer combination may even rollover.

- ▶ Under no circumstances should you try to straighten the vehicle/trailer combination by increasing your speed.
- ▶ Reduce the speed and do not countersteer.
- ▶ Brake if necessary.

Retrofitting a trailer hitch is permissible only if a trailer load is specified in your vehicle documents. If this is not the case, the vehicle is not approved for trailer operation.

Further information can be obtained at a qualified specialist workshop.

For a detachable trailer coupling, it is essential to comply with the operating instructions of the trailer coupling manufacturer.

Couple and uncouple the trailer carefully. If you do not connect the trailer to the towing vehicle correctly, the trailer may become detached.

Observe the following notes on the tongue weight:

- Do not use a tongue weight that exceeds or falls below the permissible tongue weight

- Use a tongue weight as close as possible to the maximum tongue weight

Do not exceed the following values:

- Permissible towing capacity
- Permissible rear axle load of the towing vehicle
- Permissible gross weight of the towing vehicle
- Permissible gross weight of the trailer
- Maximum permissible speed of the trailer

Ensure the following before starting a journey:

- The tire pressure on the rear axle of the towing vehicle is set for a maximum load
- The lighting of the connected trailer is operational

In the event of increased rear axle load, the car/trailer combination must not exceed a maximum speed of 62 mph (100 km/h) for reasons concerning the operating permit. This also applies in countries in which the permissible maximum speed for car/trailer combinations is above 62 mph (100 km/h).

Attaching the ball neck

⚠ WARNING Risk of accident and injury due to incorrectly installed ball neck

If the ball neck is not properly mounted and secured, it may come loose along with the trailer while the vehicle is in motion and endanger other road users. There is a risk of fatal injuries.

- ▶ Mount and secure the ball neck as described in the installation instructions of the ball neck manufacturer.
- ▶ With the ball neck mounted, always make sure it is properly secured before commencing a journey.

Attaching the ball neck

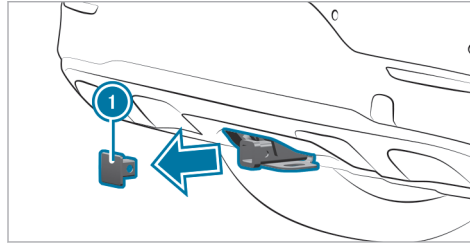

- ▶ Secure the vehicle against rolling away.
- ▶ Remove cover cap ❶ from the ball neck mount in the direction of the arrow.
- ▶ Store cover cap ❶ such that it cannot move around.
- ▶ Comply with the installation instructions of the ball neck manufacturer.

Observe the notes on loading the vehicle.

- ❶ To ensure that the Trailer Maneuvering Assist functions properly, the taught-in values for the ball head position must be reset after each change of trailer, ball neck, or ball head posi-

tion. A calibration drive must then be performed again. Information on resetting and the calibration drive (→ page 307).

Coupling up/uncoupling a trailer

⚠ WARNING Risk of injury due to a change in vehicle level

Vehicles with AIRMATIC: the vehicle level may be changed unintentionally, e.g. by other persons. If you couple or uncouple the trailer during this time, you may become trapped. In addition, other people could become trapped if their limbs are between the vehicle body and the tires or underneath the vehicle.

Observe the following when coupling or uncoupling:

- ▶ Do not open or close any doors or the tailgate.
- ▶ Do not initiate the level control system and do not operate DYNAMIC SELECT.
- ▶ Do not lock or unlock the vehicle.

The trailer will be correctly detected by the vehicle only if the following conditions are met:

- The trailer is connected correctly.
 - The trailer lighting system is in working order.
- i** Before using Trailer Maneuvering Assist and after each change of trailer, a calibration drive must be carried out with the ball neck being used (→ page 307).

A correctly connected trailer influences, among other things, the functions of the following systems:

- ESP® trailer stabilization
- Trailer Maneuvering Assist
- Active Lane Keeping Assist
- Parking Assist PARKTRONIC
- Active Parking Assist
- Blind Spot Assist or Active Blind Spot Assist
- Drive Away Assist
- Cross traffic warning
- Maneuvering brake function
- Rear view camera

- 360° camera
- AIRMATIC

Vehicles without AIRMATIC: The ball head height will change depending on the vehicle's load. In this case, use a trailer with a height-adjustable drawbar.

Coupling up a trailer

! **NOTE** Damage to the starter battery due to full discharge

Charging the trailer battery using the power supply of the trailer can damage the starter battery.

- ▶ Do not use the vehicle's power supply to charge the trailer battery.

Information about a suitable ball neck for Mercedes-Benz vehicles can be obtained from a qualified specialist workshop, e.g. an authorized Mercedes-Benz Center.

- ▶ Secure the vehicle against rolling away.

- ▶ Remove the cover cap from the ball neck mount and store it in a safe place (→ page 305).
- ▶ Position the trailer on a level surface behind the vehicle and couple it up to the vehicle.
- ▶ Establish the electrical connection between the vehicle and the trailer.

- i** Accessories can be connected to the permanent power supply up to 180 W and to the power supply that is switched on via the ignition lock.

Uncoupling a trailer

! **WARNING** Risk of being crushed and becoming trapped when uncoupling a trailer

When uncoupling a trailer with an engaged inertia-activated brake, your hand may become trapped between the vehicle and the trailer drawbar.

- ▶ Do not uncouple trailers with an engaged overrun brake.

! **NOTE** Damage during uncoupling with an engaged overrun brake

The vehicle may be damaged if you uncouple with an engaged overrun brake.

- ▶ Do not uncouple trailers with an engaged overrun brake.

! **WARNING** Risk of becoming trapped when disconnecting the trailer cable

Vehicles with AIRMATIC: the vehicle may lower when you disconnect the trailer cable.

This could result in other people becoming trapped if their limbs are between the vehicle body and the tires or underneath the vehicle.

- ▶ Make sure nobody is underneath the vehicle or in the immediate vicinity of the wheel arches when you disconnect the trailer cable.

- ▶ Secure the vehicle against rolling away.
- ▶ Disconnect the electrical connection between the vehicle and the trailer.

- ▶ Uncouple the trailer.
- ▶ Remove the ball neck and, in doing so, observe the installation instructions from the ball neck manufacturer.
- ▶ Place the cover on the ball neck mount.

Making settings for trailer operation

Multimedia system:

-  ▶ Settings ▶ Vehicle ▶ Driving
- ▶▶ Trailer settings

Making settings for a trailer

The settings in this menu enable the energy forecast at the start of the trip to be calculated more accurately. Thus the amount of energy, charging station scheduling, charging time and arrival time are calculated more accurately.

- ▶ Select the desired trailer type.
- ▶ Enter the maximum permissible speed of the set trailer.
- ▶ **To save changes:** select **Confirm**.

Calibrating a trailer coupling

- ▶ Select **Trailer coupling has been changed** to start calibration for the new ball head position.
- ▶ **To save changes:** select **Confirm**.
- ▶ Then activate Trailer Maneuvering Assist and follow the corresponding instructions in the central display. As soon as the **Activated: Trailer Maneuvering Assist** message is displayed, calibration is complete. Trailer Maneuvering Assist can now be used.

Vehicle towing instructions

The vehicle is not suitable for the use of tow bar systems that are used for flat towing or dinghy towing, for example. Attaching and using tow bar systems can result in damage to the vehicle. When you are towing a vehicle with tow bar systems, safe driving characteristics cannot be guaranteed for the towing vehicle or the towed vehicle. The vehicle-trailer combination may swerve from side to side.

Observe the following information:

- Permitted towing methods (→ page 400)

308 Driving and parking

- The notes on towing the vehicle with both axles on the ground (→ page 400)

Notes on the driver's display

⚠ WARNING Risk of accident if the driver display fails

If the driver display has failed or is malfunctioning, function restrictions in systems relevant to safety cannot be detected.

The operating safety of your vehicle may be impaired.

- ▶ Drive on carefully.
- ▶ Have the vehicle checked immediately at a qualified specialist workshop.

! NOTE Mercedes-AMG vehicles

- ▶ Observe the notes in the Supplement. You could otherwise fail to recognize dangers.

If the operating safety of your vehicle is impaired, park the vehicle immediately and safely. Contact a qualified specialist workshop.

The driver's display shows the following basic information:

- Speed and power meter level
- Range according to average consumption, personal driving style or high-consumption driving style
- State of charge of the high-voltage battery
- Indicator and warning lamps

Additional functions available include the following:

- Different menus, e.g. for assistance and navigation
- Status displays for the driving systems
- Display messages

Some menu content and settings can be customized.

Notes on the range

The range in general

- All ranges shown are assumptions based on various calculation bases. The actual range achieved may differ from the range displayed.
- Outside temperatures, climate control settings, vehicle interior temperatures, road conditions, driving style etc. directly influence the achievable range.
- Pay attention to the charging prompts at all times.

Range according to personal driving style

- Your previous personal consumption will be taken into account when the range is being calculated.
- While the navigation system or commuter route is active, additional information about the route ahead can be included in the range calculation.

Range with low consumption

- The maximum range shows the potential range when consumption is low, e.g. as a result of

310 Driver's display

economical driving or having the air conditioning system turned off.

Range with high consumption

- The minimum range shows the range when consumption is high, e.g. as a result of a sporty driving style or having the air conditioning system turned on.
- This range is determined based on past and current consumption figures.

Electrical consumption

- The **From Start** and **From Reset** consumption figures take into account all active consumer equipment when it comes to the drive system's operational readiness **READY**.

- ① If the range maximization function is switched on, the range on the speedometer may increase depending on the potential range (→ page 194).

Notes on the 3D driver's display

The 3D driver's display enables a three-dimensional representation of the content of the driver's

display. This requires the driver to be recorded by the driver camera.

The system may be impaired or may not function in the following situations:

- The driver camera is deactivated or is not working.
- The driver is outside the detection range of the driver camera.
- The operating conditions are not in place, e.g. if the outside temperature is too low or too high.

Operating the driver's display

⚠ WARNING Risk of distraction from information systems and communications equipment

If you operate information systems and communication devices integrated in the vehicle when driving, you could be distracted from the traffic situation. This could also cause you to lose control of the vehicle.

- ▶ Only operate this equipment when the traffic situation permits.
- ▶ If you cannot be sure of this, stop the vehicle whilst paying attention to road and traffic conditions and operate the equipment with the vehicle stationary.

Observe the legal requirements for the country in which you are currently driving when operating the driver's display.

Scrolling on the menu bar

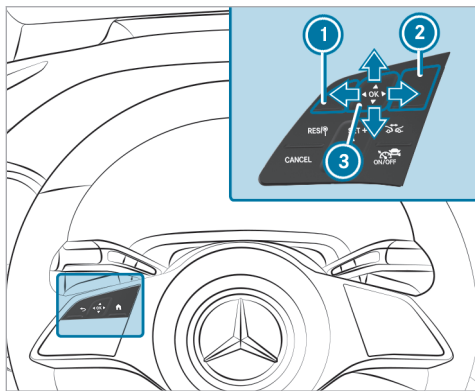

- ① Back button
- ② Main menu button
- ③ Touch Control

The content on the driver's display is controlled using the control elements on the left side of the steering wheel. You can use Touch Control ③ to navigate vertically and horizontally by swiping with

one finger. Confirm your selection by pressing the Touch Control.

- ① To operate Touch Control ③ in the most effective way, use the tip of your thumb if possible. You can also set the sensitivity of the Touch Control on the central display .
- ▶ Briefly press main menu button ② .
- ▶ Select a menu by swiping to the left or right on Touch Control ③ .
- ▶ **To confirm:** press Touch Control ③ .

Driver display menus

Notes on menus on the driver's display

⚠ WARNING Risk of distraction from information systems and communications equipment

If you operate information systems and communication devices integrated in the vehicle when driving, you could be distracted from the traffic situation. This could also cause you to lose control of the vehicle.

- ▶ Only operate this equipment when the traffic situation permits.
- ▶ If you cannot be sure of this, stop the vehicle whilst paying attention to road and traffic conditions and operate the equipment with the vehicle stationary.

Observe the legal requirements for the country in which you are currently driving when operating the driver's display.

The following menus can be called up via the menu bar on the driver's display:

- Understated
- Sport
- Classic
- Navigation
- Assistance
- Offroad (vehicles with 4MATIC)
- Service

On some of these menus, you can choose between different display content on the center display area.

On most of the menus, you can use **Options** to configure further settings for the menu-specific display content.

You can find further information about the possible settings and selections on the menus in the Digital Operator's Manual.

Head-up Display

Function of the head-up display

The head-up display projects various content into the driver's field of vision, for example.

You can use the head-up display menu bar to select various contexts, e.g.:

- Minimal
- Sport
- Standard
- Offroad (vehicles with 4MATIC)
- ECO display (depending on model and equipment) (→ page 190)
- Settings
- Head-up display on/off

The following image shows an example of the head-up display. You can choose what content is displayed (→ page 312).

Head-up display content with navigation (9x3°)

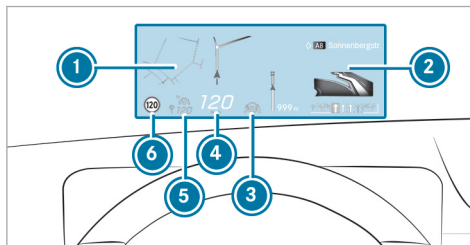

- 1 Navigation instructions
- 2 Navigation instructions (distance to the next route event)
- 3 Steer Assist status
- 4 Current speed
- 5 Set speed in the driving system (e.g. cruise control)
- 6 Detected traffic signs (Traffic Sign Assist)

When you receive a call, the  **Call Waiting** message will appear on the head-up display and the driver's display.

System limits

Visibility is particularly influenced by the following conditions:

- Seat position
- Image position setting
- Ambient light
- Wet road surfaces
- Objects on the display cover
- Polarization in sunglasses

Operating the head-up display

Selecting display content of the head-up display via the menu bar of the driver's display

- ▶ Press the  main menu button on the left.
- ▶ **To select the menu bar of the head-up display:** swipe upwards on the left-hand Touch Control.



Switching between display content on the head-up display

- ▶ Swipe to the left or right on the left-hand Touch Control.
A preview of the selected display content will appear on the head-up display.
- ▶ **To confirm:** press the **OK** button.

Switching back to the driver's display

- ▶ Press the **←** or **Home** button.

Setting the position and brightness

- ▶ Swipe to the left or right on the left-hand Touch Control and select **Settings** on the menu bar of the head-up display.
- ▶ Press the left-hand Touch Control.
The current position and brightness settings will be displayed as graphics on the head-up display as well as on the driver's display.
- ▶ **To adjust the position:** swipe upwards or downwards on the left-hand Touch Control.
- ▶ **To adjust the brightness:** swipe to the left or right on the left-hand Touch Control.
The settings configured for position and brightness will be saved automatically.
- ▶ Press the **←** or **OK** button to exit the settings.

Switching the head-up display on/off

Driver's display:



Switching on

- ▶ Swipe upwards on the left-hand Touch Control.
- ▶ Press **OK** on the left-hand Touch Control.

Switching off

- ▶ Swipe upwards on the left-hand Touch Control.
- ▶ Swipe on the left-hand Touch Control and select **Head-up Display**.
- ▶ Press **OK** on the left-hand Touch Control.



Overview of status displays on the driver's display



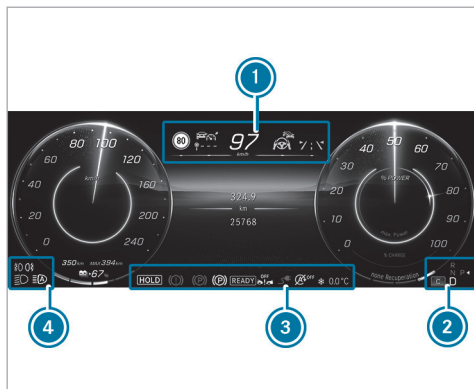











The status displays for the driving and driving safety systems can be found in display sections

① to ④.





i The number, positions and presentation of the status indicators on the driver's display depend on which systems are activated or deactivated.

-  Pedestrian detection (only on assistant display)
-  Active Parking Assist is available (→ page 286)

-  Active Parking Assist has recognized a parking space (→ page 286)
-  Parking Assist PARKTRONIC deactivated (→ page 284)
-  Cruise control (→ page 234)
-  Active Distance Assist DISTRONIC (→ page 237)
-  Specified distance for Active Distance Assist DISTRONIC (→ page 237)
-  Active Brake Assist switched off (→ page 259)
-  Active Brake Assist impaired or not functioning (→ page 259)
-  Active Steering Assist (→ page 246)
-  Active Lane Change Assist (→ page 250)
-  Active Lane Keeping Assist (→ page 267)
-  Active Blind Spot Assist (only on assistant display) (→ page 266)
-  Haptic accelerator pedal (→ page 194)
-  HOLD function (→ page 230)
-  Adaptive Highbeam Assist (→ page 151)

Adaptive Highbeam Assist Plus (→ page 152)

-  Active Stop-and-Go Assist (→ page 244)
-  Slippery road surface warning

Vehicles with Traffic Sign Assist: detected instructions and traffic signs (→ page 259)

Overview and operation

Notes on the MBUX multimedia system

⚠ WARNING Risk of distraction from information systems and communications equipment

If you operate information systems and communication devices integrated in the vehicle when driving, you could be distracted from the traffic situation. This could also cause you to lose control of the vehicle.

- ▶ Only operate this equipment when the traffic situation permits.
- ▶ If you cannot be sure of this, stop the vehicle whilst paying attention to road and traffic conditions and operate the equipment with the vehicle stationary.

You must observe the legal requirements for the country in which you are currently driving when operating the multimedia system. Depending on the equipment, the scope of function and product designation of your MBUX multimedia system may differ from the description and

images in this Operator's Manual. For example, route guidance with augmented reality is not available in all equipment variants.

! NOTE Increased surface temperature due to direct sunlight on the central display/ front passenger display

The surface of the display is very dark.

If the display is exposed to direct sunlight, the surface may heat up considerably.

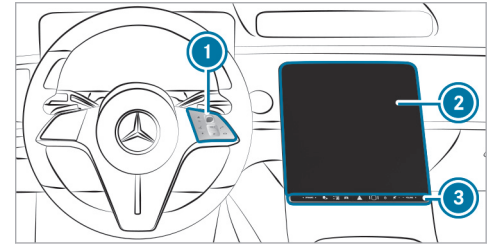

- ▶ If the display has been exposed to direct sunlight, allow it to cool down before touching it for a longer period of time.

Overview of the MBUX multimedia system



Vehicles with central display



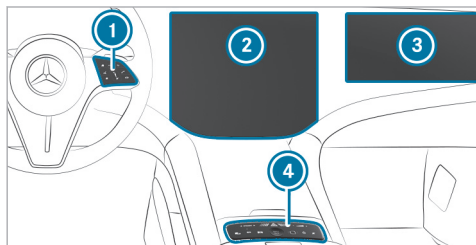

- ① Touch Control and control panel for the MBUX multimedia system
MBUX stands for Mercedes-Benz User Experience.
 - Operates Touch Control
- ② Central display with touch functionality
 - Home screen overview
 - Operates the touchscreen
- ③ Switch panel with:
 - ▣ Fingerprint sensor

-  Switches the MBUX multimedia system on or off
-  Switches sound on or off
-  Adjusts the volume



Vehicles with MBUX Hyperscreen

- ① Touch Control and control panel for the MBUX multimedia system
 - Operates Touch Control
- ② Central display with touch functionality for the driver
 - Home screen overview
 - Operates the touchscreen

- ③ Front passenger display with touch functionality
 - Home screen overview
 - Operates the touchscreen
- ④ Switch panel with:
 -  Fingerprint sensor
 -  Switches the MBUX multimedia system on or off
 -  Switches sound on or off
 -  Adjusts the volume

Further operating options:

- Conducting a dialog with the MBUX voice assistant.
- ① You can find further information about operation as well as about applications and services in the Digital Operator's Manual.

Front passenger display (only vehicles with MBUX Hyperscreen)

⚠ WARNING Risk of accident and injury due to distraction when the driver is looking at the front passenger display

If you look at the front passenger display while driving, you may be distracted from the traffic. This could also cause you to lose control of the vehicle. The front passenger display is intended exclusively for the front passenger.

- ▶ Keep the actual traffic situation constantly in view.
- ▶ Avoid looking at the front passenger display while driving.

The front passenger display is an additional touchscreen specifically for the front passenger. Requirements for displaying content on the front passenger display while driving:

- The passenger is sitting on the passenger seat.
- The driver camera is switched on (→ page 328).

In the status line of the central display is shown as a  white symbol.

- The driver camera detects the driver's head and line of sight.

It displays content from the MBUX multimedia system independently of the central display. Depending on the application, operation is independent of the driver. Depending on the market, extended content, e.g. playback of media content, is also available while driving.

For the playback of certain content on the front passenger display, e.g. moving images, it is necessary to connect Bluetooth® headphones.

If the driver keeps their eyes on the front passenger display for too long, content, e.g. moving images, will be hidden. An intelligent, camera-based blocking concept is used for this purpose.

- ① When the vehicle is parked, the front passenger can use the front passenger display under the following conditions:
 - The passenger is sitting on the passenger seat.

- There is interaction with the MBUX multimedia system.

If the driver has left the vehicle briefly, e.g. to go shopping, the front passenger display can also be operated.

- ① If no front passenger is present, a digital decorative image can be shown on the front passenger display.

Anti-theft protection

This device is equipped with technical provisions to protect it against theft. Further information on anti-theft protection can be obtained at an authorized Mercedes-Benz Center.

Zero layer

■ Function of the zero layer

The zero layer provides you with dynamic content from the MBUX multimedia system and is used to quickly access and control the applications you use. When you select  on the central display, the digital map with the applications appears in the lower display area. Compared to the home screen with a classic menu, the steps required to

call up the applications are reduced. You can switch between the zero layer and the home screen with a classic menu.

The applications can be hidden from the display area and shown again.

The zero layer provides the following modules and applications:

- EQ module and navigation module

The EQ module is always shown on the digital map. In the expanded view, charging settings and navigation functions are offered.

- Entertainment (media, radio) and telephone
When the lower display area is shown, the entertainment sources are always displayed.

A mobile phone must be connected to the MBUX multimedia system for the phone to be displayed.

- Active applications

The lower display area shows an active message program, for example.

- Suggestions

Suggestions are displayed on the lower display area based on context and your user behavior. Here are a few examples:

- Latest calls
- Active message programs
- Vehicle functions
- Online voice applications
- Online voice applications

In the lower display area, context-dependent services that can be executed via voice are available for direct access.

The applications are first displayed in a reduced view. By tapping on them, you can operate them or open the associated menu (expanded view).

A long press on a suggestion opens a context menu in which further functions are available.

The learning function can be switched on and off for the options (→ page 329).

Overview zero layer

Digital map and user-specific applications (example)

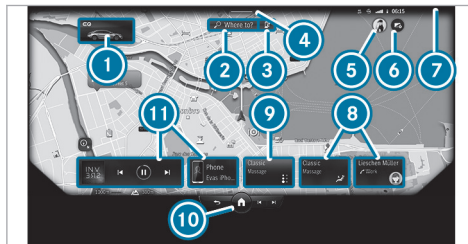

- 1 EQ module (reduced view)
- 2 Enters a destination
- 3 Searches for a charging station
- 4 Calls up the Control Center: pull the bar down
- 5 Calls up user profile settings
- 6 Content sharing menu
- 7 Status line
- 8 Suggestions

Requirement: suggestions are activated (→ page 329).

- 9 Active application, e.g. message program



Press briefly: displays all applications and the global search (→ page 320)

Press and hold: calls up the home screen with classic menu

- 11 Entertainment sources (media, radio) and telephone

Requirement for phone: the mobile phone is connected to the MBUX multimedia system.

The zero layer shows the digital map and the user-specific applications.

The following user-specific applications are displayed in the lower display area:

- Suggestions 8
- Active applications 9
- Entertainment sources and telephone 11
- Online voice applications

The lower display area can be hidden and shown (→ page 320).

Information about entertainment sources

You can operate the applications in the reduced view or in the menu (expanded view) (→ page 320).

Examples:

- Control a media source, e.g. pause/play, next track, set a station
- Select tracks from the current playlist or stations from the station list
- Select a media source
The media source must be connected to the MBUX multimedia system.

Information about the telephone

To use the functions, your mobile phone must be connected with the MBUX multimedia system.

Requirement for suggestions: the [Calls & Messages](#) option is activated in the suggestions.

Examples:

- Answer a call and call a missed call
The missed calls are displayed for the mobile phone currently connected to the MBUX multimedia system.

- Display contacts and call list and call a contact
- Use voice functions
- Suggest contacts
The contacts are suggested for the mobile phone connected to the MBUX multimedia system. No contacts are suggested for a mobile phone that is linked to another user profile.
- Write messages to contacts (suggestion)
- Connect a device via the device manager (suggestion)

Information about active applications

The following functions are available:

- Operating the massage program
- Operating an ENERGIZING COMFORT program
- Raising or lowering the vehicle level

Suggestions for comfort and vehicle functions as well as navigation

Requirement: the [Comfort](#), [Vehicle](#) and [Navigation](#) options are activated in the suggestions.

- Operating the massage program
For example, the multimedia system suggests a program at a certain time.
- Operating an ENERGIZING COMFORT program
- Opening the tailgate
Requirement: the vehicle is equipped with trunk lid convenience closing.
- Opening and closing the convenience doors
Requirement: the vehicle is equipped with comfort doors.
- Setting the vehicle level
- Making heating settings
- Activating/deactivating Parking Assist PARKTRONIC
- Selecting previous destinations and destinations from favorites

Suggestions for online voice applications

Requirement: the [Online Voice Services](#) option is activated in the suggestions.

The suggested voice applications are made available online and are based on your previous voice inputs.

Examples:

- What will the weather be like tomorrow?
- Play the messages.
- Start geoquiz.
- Open the garage door.

Calling up and operating the zero layer

Calling up the zero layer



When the vehicle has been switched on, the zero layer is displayed with the digital map. Navigation is active.

▶ **From another application:** press the  button on the right side of the steering wheel.

or



▶ Tap on .

Operating applications in the reduced view (examples)

▶ **Media:** to play the previous or next track, tap  or .

- ▶ **To answer a call or call a missed call:** tap on the contact.
After the connection has been established, the call functions are available.
- ▶ **To end a call:** tap on the contact again.
- ▶ **To reply to message:** tap on a message and dictate the message via the MBUX Voice Assistant.
- ▶ **To start a message program:** tap on the application and start the message program.
- ▶ **To select a previous destination:** tap on the application and select one of the previous destinations.
- ▶ **To select a destination from the favorites:** tap on the application and select the destination.

Hiding and showing the display area with applications

- ▶ **To hide:** pull the applications down.
 - ▶ **To show:** pull the bar above  upwards.
- or
- ▶ Select .
- or

▶ Press the  button on the steering wheel on the right.

EQ module (expanded view)

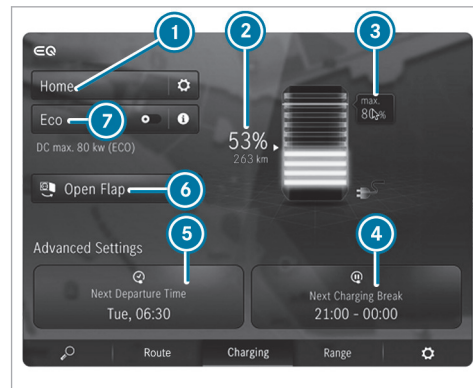



- 1 Setting the charging program (→ page 216)
- 2 Current condition of charge of the high-voltage battery
- 3 Maximum condition of charge (depending on the setting)

- ④ Sets the next charging break (to use a less expensive tariff)
- ⑤ Sets the departure time
- ⑥ Opens the socket flap
- ⑦ Activates or deactivates ECO charging

▶ Tap on the EQ module (→ page 318). The charging settings are displayed.

Additional EQ and navigation functions are available in the lower menu bar:

- Symbol  Enters a destination
- **Route**
The route shows charging stops and the destination.
- **Range**
Switches range maximization on or off (→ page 195).
- **Consumption**
The current and average fuel consumption will be displayed.
- Symbol 

Makes settings for **View, Messages & Acoustic Signals** and **Route**.

▶ To close the menu: select .

Navigation module (expanded view)

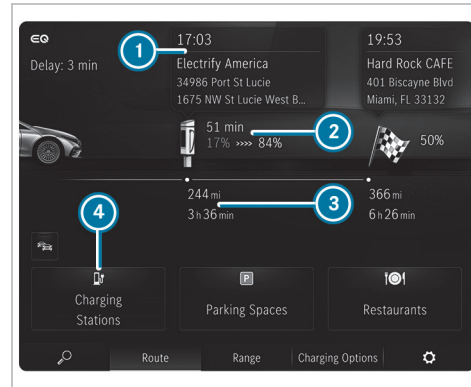

Example: navigation module with active route guidance

- ① Arrival time at charging stop, type of charging station

- ② Charging stop shows the charging time recommended by the Navigation with Electric Intelligence as well as states of charge on arrival and onward journey for an optimal travel time
 - ③ Distance from current vehicle position and remaining driving time
 - ④ Searches for an additional charging station
- ▶ Tap on the EQ module (→ page 318).
▶ Select **Route** in the lower menu bar.

Operating a menu in the lower display area (example: active massage program)



- 1 Selects a massage program
 - 2 Starts/stops a massage program for the driver
 - 3 Starts/stops a massage program for the front passenger
 - 4 Sets the massage program intensity for the driver's or front passenger seat
- ▶ Tap on the application. The expanded view of the application is displayed.
 - ▶ **To close the menu:** select .



Opening and closing the context menu for a suggestion

- ▶ Press and hold on a suggestion. The context menu opens and shows the **No Longer Suggest** option, for example.
- ▶ **To close:** swipe downwards.



Removing a suggestion from the display area

- ▶ Swipe the suggestion upwards.

Showing all applications

- ▶ Press  briefly. Available applications are displayed. The global search is available.
- ▶ **To hide applications:** briefly press  again.

Switching between zero layer and home screen with classic menu

- ▶ Long press on . The home screen with classic menu is shown.
- ▶ **To return to the zero layer:** press and hold on .

Home screen overview



- 1 Displays in the status line
 - 2 Calls up user profile settings and switches user
 - 3 Calls up the Control Center: pull the bar down
 - 4 Calls up favorites
 - 5 Displays in the status line
 - 6 Displays further applications
 - 7 Calls up an application
 - 8 Quick-access to application
 - 9 Global menu
- ▶  Calls up previous menu

 Press and hold: switches between home screen and zero layer

 Previous track or previous radio station

 Next track or next radio station

i During a telephone call, the call duration is displayed in global menu **9**.

The following functions are called up in the Control Center:

- Notifications Center
- Content sharing menu
- Favorites
- Vehicle quick-access

Content sharing menu in the Control Center

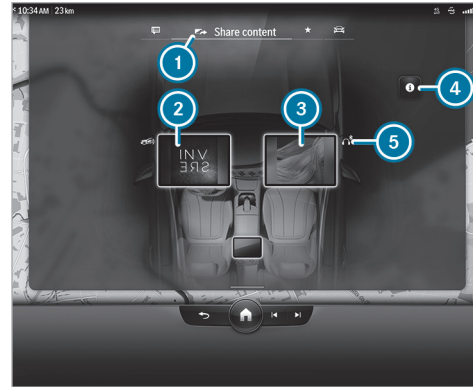

Example: content sharing menu

- 1** Calls up a menu
- 2** Central display with active content (cover display)
- 3** Front passenger display

4 Displays animation for content sharing

5  Bluetooth® headphones connected to the front passenger display on the right

To share content, drag a display and drop it over another display.

To control media playback, tap a display.

Operating the MBUX multimedia system

Using Touch Control

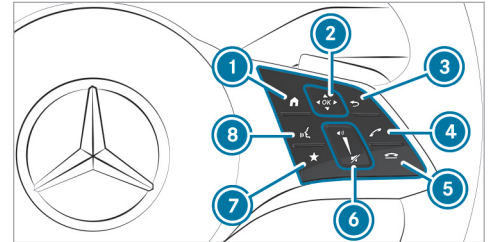

1  Shows the home screen

2 Touch Control

- ◀ ▶ ↶ ↷ swipe in the direction of the arrow (navigate)
- OK Press (confirm)
- ③ ↶ Returns to the previous display
- ④ ☎ Makes or accepts a call
- ⑤ ☎ Rejects or ends a call
- ⑥ ↑ To increase volume: swipe upwards
↓ To reduce volume: swipe down
- 🔇 Switches off the sound: press
- ⑦ ★ Calls up favorites (press briefly) or adds favorites (press and hold)
- ⑧ 🗣 Starts the MBUX Voice Assistant

You can navigate through menus and lists via the touch-sensitive surface of Touch Control ② using a **single-finger swipe**, for example:

- ▶ **To enter a character:** select a character using the keyboard and press on Touch Control ②.
- ▶ **To select a menu option:** scroll in a list and press Touch Control ②.
- ▶ **To move the digital map:** swipe in any direction.

Using the touchscreen

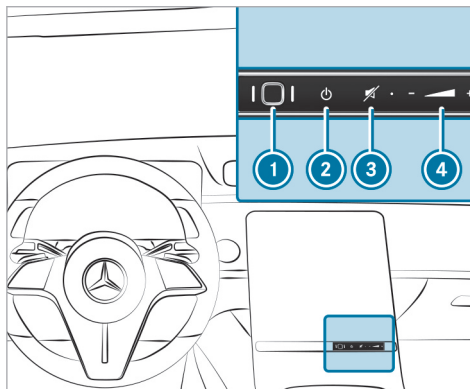

Example: control elements for vehicles with a central display

- ① Fingerprint sensor
- ② Switches the MBUX multimedia system on or off
- ③ Switches the mute function on/off

- ④ Adjusts the volume
Press $-$ or $+$ or swipe over the button

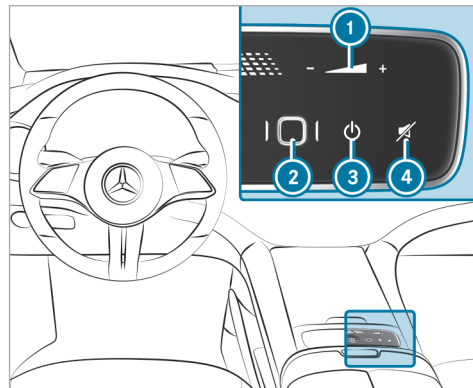

Example: control elements for vehicles with an MBUX Hyperscreen

- ① Adjusts the volume
Press $-$, or $+$.
- ② Fingerprint sensor

- ③ Switches the MBUX multimedia system on or off
- ④ Switches the mute function on/off
- ▶ **To select a menu item or entry:** tap on a symbol or an entry.
- ▶ **To increase the map scale:** tap twice quickly with one finger.
- ▶ **To reduce the map scale:** tap with two fingers.
- ▶ **To enter characters with the keypad:** tap on a button.
- ▶ **To navigate in menus:** swipe up, down, left or right.
- ▶ **To use handwriting to enter characters:** write the character with one finger on the touchscreen.
- ▶ **To zoom in and out of the map:** move two fingers together or apart.
- ▶ **To enlarge or reduce the size of a section of a website:** move two fingers together or apart.
- ▶ **To turn the digital map:** turn counter-clockwise or clockwise using two fingers.

- ▶ **To move the digital map:** touch the touchscreen and move your finger in any direction.
- ▶ **To save the destination in the digital map:** touch the touchscreen and hold until a message is shown.
- ▶ **To set the volume on a scale:** touch the touchscreen and move the finger to the left or right.
- ▶ **To call up a global menu in the applications:** touch the touchscreen and hold until the **Options** menu appears.

Function of the MBUX voice assistant

⚠ WARNING Risk of distraction from information systems and communications equipment

If you operate information systems and communication devices integrated in the vehicle when driving, you could be distracted from the traffic situation. This could also cause you to lose control of the vehicle.

- ▶ Only operate this equipment when the traffic situation permits.
- ▶ If you cannot be sure of this, stop the vehicle whilst paying attention to road and traffic conditions and operate the equipment with the vehicle stationary.

For your own safety, always observe the following points when operating mobile communications equipment and especially your voice control system:

- Observe the legal requirements for the country in which you are driving.
- If you use the voice control system in an emergency your voice can change and your telephone call, e.g. an emergency call, can thereby be delayed.
- Familiarize yourself with the voice control system functions before starting the journey. Using the MBUX voice assistant, vehicle functions and various areas of the MBUX multimedia system can be operated by voice input. The MBUX voice assistant is operational approximately half a minute after switching on the vehicle and can be

operated from all seats. Further information and examples of voice commands can be found in the Digital Operator's Manual.

You can use the MBUX voice assistant to operate the following functions depending on the vehicle equipment:

- Telephone
- Text message and e-mail
- Navigation
- Radio and media
- Vehicle functions
- Online functions

Full functionality of the voice control system is only available for you with activation of online voice control.

Conducting a dialog

Starting a dialog

- ▶ Say "Hey Mercedes" to activate the MBUX voice assistant. Voice activation must be switched on in the multimedia system.

or

- ▶ Press the  button on the multifunction steering wheel.

A blue line appears in the MBUX multimedia system. The dialog can be started.

For the dialog with the MBUX voice assistant, you can use complete sentences of colloquial language as voice commands. Voice activation can also be directly combined with a voice command, e.g. "Hey Mercedes, how fast can I drive?".

Calling up help

- ▶ **For information about the MBUX voice assistant:** say "Hey Mercedes, what can you do?"
- ▶ **Digital Operator's Manual:** "Show me the Operator's Manual". The full extent of the Digital Operator's Manual is available when the vehicle is stationary.

Operating functions (examples)

- ▶ **To operate the navigation:** "Search for an Asian restaurant, but not Japanese, in South Manhattan."
- ▶ **To operate the phone:** "Call my father."

- ▶ **To change the system language to English (short command):** "Change language to English".
- ▶ **To operate the radio:** "Show me the list of radio stations."
- ▶ **To operate media:** "Switch on random playback."
- ▶ **To operate vehicle functions:** "Switch the seat heating to level 2."
- ▶ **To operate online functions:** "What's the time in Sydney?"
- ▶ **To ask a question about the vehicle:** "Do I have Blind Spot Assist?"

Function of the driver camera

The driver camera is on the driver display or in the 3D driver display.

The driver camera is available either as a mono or a stereo camera.

The driver camera detects the following characteristics:

- Head position

- Viewing direction
 - Eyelid closure characteristics
 - Driver's face
- i** The driver camera is automatically activated each time the vehicle is opened with the SmartKey.
The current status of the  driver camera is shown in the status line of the central display.
- i** The driver camera records image data for applications such as ATTENTION ASSIST and facial recognition, for example.
The camera converts the image data directly into meta data. No image data is saved in the process. The data is only processed in the vehicle and is not transmitted from the vehicle.

The driver camera must be set up for face detection before use. Teaching-in biometric data (→ page 329).

System limits

The system may be impaired or may not function in the following situations:

- The camera is covered or dirty, fogged up or scratched.
- The driver's face and/or eyes are covered.
- The driver is wearing glasses that block infrared.

Display messages

In the following situations display messages may be shown:

- The driver camera is inoperative.
The camera is faulty.
The [Driver Camera Inoperative See Operator's Manual](#) message appears.
- The driver camera cannot capture the position of your head.
The [Change the steering wheel/ seat position until 6 dots are visible on the upper edge of the screen.](#) message appears.
- The view of the driver camera is reduced or restricted.

The [Driver Camera View Currently Restricted See Operator's Manual](#) message appears.

The message can appear, for example, in the following cases:

- The camera's view is obstructed, e.g. due to a scarf or hat being worn.
- The driver is wearing glasses that block infrared.
- If hair partially obstructs the eyes, e.g. as with a long fringe.
- In the event of strong direct sunlight. The driver camera cannot detect the driver's eyes if the light-dark contrast is too strong.
- When one or both hands are on top of the steering wheel (twelve o'clock position).

Notes on care

Please comply with the notes on caring for the interior (→ page 387).

Switching the driver camera on or off

Multimedia system:

→ →  → Settings → System
 → Intelligent Assistance

The driver camera is automatically activated each time the vehicle is switched on.

▶ Select **On** or **Off**.

When the driver camera is switched off or the **Driver Camera View Currently Restricted See Operator's Manual** message appears, the following functions are not available or limited:

- The 3D driver's display (only for stereo camera) (→ page 310)
- The microsleep and distraction detection of ATTENTION ASSIST (→ page 233)
- The facial recognition

This function serves as sensor input for authentication and unlocking of the user profile and protected applications (→ page 329).

Information on users, suggestions and favorites

⚠ WARNING Risk of becoming trapped during adjustment of the driver's seat after calling up a driver profile

Selecting a user profile may trigger an adjustment of the driver's seat to the position saved under the user profile. You or other vehicle occupants could be injured in the process.

▶ Make sure that when the position of driver's seat is being adjusted using the multimedia system, no people or body parts are in the seat's range of movement.

If there is a risk of someone becoming trapped, immediately stop the adjustment process by:

▶ a) Pressing the warning message on the central display.

or

▶ b) Pressing a position button of the memory function or a seat adjustment switch in the driver's door.

The adjustment process is stopped.

The driver's seat is equipped with an anti-entrapment feature.

If the driver's door is open, the driver's seat will **not** be set after calling up the driver's profile.

User profiles and user-specific content

Prerequisites for the vehicle owner:

- You have a Mercedes me user account.
- You have a Mercedes me PIN.
- You have agreed to the terms of use.
- The vehicle is linked to a Mercedes me user account.

i If one of the requirements listed is missing or if no user profile has been selected, the data described in the following section will be saved in the vehicle as the standard setting. Standard settings can be changed by all vehicle users.

User profiles save personal settings. If the vehicle is used by several people, a person can change their profile settings without changing the settings of other users.

You can individualize a user profile in the vehicle using the set-up assistant or using the settings in your user profile. Some settings, e.g. the Mercedes me PIN and a profile photo are made in the Mercedes me App or in the Mercedes me Portal.

User-specific content and applications with personal data are protected by different levels of security. To access protected content, the Mercedes me PIN and, depending on the vehicle equipment, biometric sensors can be used.

- i** The security level is set by the multimedia system and calculated from the combination of all sensor inputs. Some security levels cannot be turned off.
- i** When a user profile is activated, the following personalized comfort systems, for example, can be adjusted or their settings loaded:
 - Seat
 - Ambient light
 - Outside mirrors
 - Blinds
 - Climate control settings

If the user profile is activated when driving, the driver's seat position will not be adjusted.

Depending on the vehicle equipment you can, as a user, save the following settings, for example:

- Driver's seat, steering wheel and mirror settings
- Climate control
- Ambient lighting
- Radio (including station list)
- Suggestions and favorites

Suggestions

The vehicle can learn the habits of the driver. It then makes suggestions regarding navigation destinations, phone numbers and music preferences. The requirements for that are the selection of a user, your consent to the recording of data and sufficient collected data.

Favorites

Favorites offer you quick access to frequently used applications. 100 favorites are available in total.

Configuring users, suggestions and favorites

Requirements

- To use the set-up assistant: the vehicle is stationary.

Multimedia system:



Adding a user

- ▶ Select **+** **Add User**.
A QR code is loaded.
- ▶ Scan the displayed QR code with the Mercedes me App or any QR code scanner on a mobile device. If the Mercedes me App is not yet installed on your mobile device, you will be directed to the store of your mobile device.
- ▶ Follow the directions in the app.
The vehicle is connected with your Mercedes me user account. This automatically creates your user profile in the vehicle.
If only your user profile is available, it will be loaded automatically.

If more than one user profile is available, you will be directed to the user selection.

When the vehicle is stationary, the set-up assistant starts automatically after user selection.

Protecting user-specific content and applications

If you add a new user, access protection is already activated for the user profile. The Mercedes me PIN and, depending on the vehicle equipment, biometric sensors are available for access. Biometric sensors in the vehicle must be taught in. The authentication process then takes all taught-in and available sensors into account.

The following user-specific content and applications are protected, for example:

- User selection and user profile settings
- Biometric sensors
 - The teaching-in of biometric sensors is protected.
- Suggestions
 - The data and determination of the most probable navigation destinations, media sources,

radio stations, contacts and messages are protected.

- **ENERGIZING COACH**
 - The recorded health data and their evaluation are protected.
 - Mercedes me connect store
 - The purchase of services is protected.
- ▶ Switch **Protect Content** on or off.
 - ▶ Switch **Access Protection** on or off.
 - ❗ When access protection is switched off, your user profile can be viewed from any seat and changes can be made.
 - ❗ Access protection is switched on or off on a vehicle-specific basis.

Teaching in, editing and deleting biometric data

The biometric data models are saved in the sensors in the vehicle. If recognition has been taught-in, this sensor serves as a contributory factor for authentication on the multimedia system.

- ▶ Select **Protect Content**.
- ▶ Select **Facial Recognition, Fingerprint Recognition** or **Voice Recognition**.

- ❗ If necessary, authenticate yourself on the multimedia system.

Authenticating using face recognition

- ▶ Close the driver's door or fasten the driver's seat belt.
- ▶ Look at the driver's display for about five seconds. Your face is scanned. A message in the driver's display shows whether facial recognition was successful or not. You can unlock your user profile and protected applications with the facial scan.

Authenticating using fingerprints

- ▶ Place and lift your finger several times on the fingerprint sensor under the touchscreen (→ page 315). The finger is scanned. If the scanning procedure is successful, a message appears on the central display. You can unlock your user profile and protected applications with your fingerprint.

Authenticating using voice recognition

- ▶ Speak the sentence shown on the central display and follow the voice assistant's instructions.
If the voice recognition was successful, a message appears on the central display. You can unlock your user profile.
- ⓘ Avoid background or disturbing noises during voice recognition.

Deleting biometric data

- ▶ Tap on , for example, behind **Facial Recognition**.
- ▶ Select **Yes**.

Teaching in the vehicle key for profile selection

- ▶ Select **Protect Content**.
- ▶ Select **SmartKey Recognition**.
- ▶ Have the key ready and follow the set-up assistant's prompts.
The user profile is linked to the selected key. If you open the vehicle with the key, the light, mirror and seat settings for your user profile



are pre-activated. The key you are currently using for unlocking is used.

The key is only stored for the driver and for one user profile.



Selecting a user

- ⓘ When you call up your driver profile, the driver's seat and the steering wheel can be set. You can cancel the setting process with the following actions:
 - Press **Tap Here to Cancel** message on the central display.
 - Press one of the seat operating buttons in the driver's door.
- ▶ Select **Change User**.
- ▶ Select a user.
- ▶ When requested to do so, authenticate with the Mercedes me PIN or a taught-in biometric characteristic.
The user profile is loaded and activated.
- ⓘ If you select **Continue Without Selecting a User**, no specific settings for the user profile are loaded.

Configuring and deleting suggestions

- ▶ Select .
- ▶ Select **Settings**.
- ▶ Select **System**.
- ▶ Select **Suggestions**.
- ▶ Select .
- ▶ Switch the options on or off individually.
If an option is switched on and sufficient data has been gathered, personalized suggestions based on your user behavior will be offered to you on the zero layer. These are, for example, navigation destinations visited, phone numbers dialed as well as suggestions based on your music preferences.
- ▶ **To delete collected suggestions:** select .
- ▶ Select **Yes**.
The suggestions are reset.

Adding favorites from categories

- ▶ Select .
- ▶ Select .
- ▶ Select .

- ▶ Select  **Create New Favorite.**
- ▶ Select the category.
- ▶ Select a favorite.

System settings

Overview of the system settings menu

In the system settings menu, you can make settings in the following menus and control elements:

- Display
 - Display brightness
 - Decorative image for the front passenger display (vehicles with MBUX Hyperscreen)
- Control elements
 - Keyboard language and handwriting recognition
 - Sensitivity of the Touch Control
 - Haptic operation for the touchscreen
- MBUX voice assistant
- MBUX Interior Assistant

- Sound
 - Entertainment
 - Navigation and traffic announcements
 - Telephone
- Data protection
- Connectivity
 - Wi-Fi, Bluetooth®, NFC
- Time & date
- Language
- Units for distance
- System PIN
- Suggestions
- Software update
- System reset

Overview of software updates

Important software updates may be necessary for the security of your multimedia system's data. Install these updates, or else the security of your multimedia system cannot be ensured.

The multimedia system displays a corresponding message when a software update is available.

If the **Automatic Online Update** option is active, software updates are downloaded automatically. If the option is deactivated, you will be informed of new software updates once. The software updates are available for downloading for a limited period of time.

Carrying out a software update:

- You can start software updates via the communication module.
- You can start software updates via a Wi-Fi hotspot.
- You can start map updates from an external medium.

 Online software updates cannot be performed via external Wi-Fi hotspots that are encrypted via TKIP.

 If the Wi-Fi hotspot requires logging in via the browser, once the connection is successfully established the browser will open in order to start the update. Follow the instructions in the browser in order to start the download.

- ❗ To complete software updates via the communication module, the vehicle must be connected with the Internet and a Mercedes me user account.
- ❗ To complete software updates via Wi-Fi, the vehicle must be connected to an external Wi-Fi hotspot.

A software update consists of three steps:

- Downloading or copying of the data required for installation
 - Installation of the downloaded software update
 - Activation of the downloaded software update
- ❗ It may be necessary to restart the MBUX multimedia system after completion of a software update.
 - ❗ While some software updates are being downloaded, the multimedia system cannot be operated and the vehicle functions may be restricted.
 - ❗ Some software updates require a safe vehicle status for the installation to be completed.

They can only be carried out in a safely parked vehicle with the vehicle switched off.

For software updates requiring a safe vehicle status: when the last installation step is reached, a message appears on the central display after the vehicle is switched off. Follow the step-by-step instructions on the central display to complete the installation.

There are software updates that can only be installed when the vehicle is safely parked, there are no more people in the vehicle and the vehicle is locked.

Availability of the driver's and central display

During the installation of software updates, it is not possible to use the vehicle, central display and driver's display. You may receive the following display message when an installation is running:

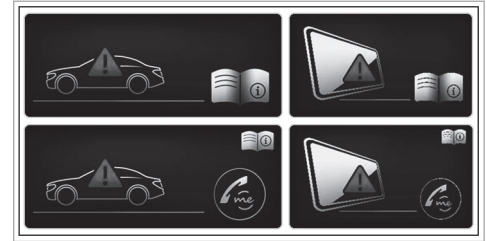

- ❗ The display message does not appear every time a software update is installed.

In rare cases, an error can occur during the installation. The multimedia system automatically attempts to restore the previous version.

If it is not possible to restore the previous version, the display message shown above appears every time the vehicle is started.

Failure of the driver's display

If the driver's display fails or there is a malfunction, you may not recognize limitations in the functions of systems relevant to safety or the speed display, for example. The operating safety of the vehicle may be impaired. Drive on carefully

and have the vehicle checked at a qualified specialist workshop immediately (→ page 477).

Further information about software updates can be found at <https://me.secure.mercedes-benz.com>

Failure of the central display

If the central display fails or the display message shown above is shown continuously, several systems such as the rear view camera, Parking Assist PARKTRONIC or climate control are no longer available. Drive on carefully and consult a specialist workshop as soon as possible.

Front passenger display failure (only vehicles with MBUX Hyperscreen)

If the front passenger display has failed or a display message appears permanently, functions and systems are no longer available via the front passenger display. Visit a qualified specialist workshop.

Setting up a Wi-Fi hotspot

Requirements

- The Wi-Fi function is activated on the multimedia system and the communication device to be connected.
- The communication device to be connected supports at least one of the types of connection described.

The connection types shown depend on the device to be connected. The function must be supported by the multimedia system and by the device to be connected. The type of connection established must be selected on the multimedia system and on the device to be connected.

- ① Some functions may first need to be activated on the communication device being connected. More detailed information can be found in the manufacturer's operating instructions.
- ① The use of the vehicle data tariff by external devices is not available in all countries.

Multimedia system:

→  » Settings » System
» Internet and Bluetooth

- ① The availability of the functions is dependent on the country.
- ▶ Select **Wi-Fi**.
The controller is to the right: Wi-Fi is switched on.

When the Wi-Fi function is switched on, you can connect the multimedia system with external hotspots or make it available as a hotspot for external devices.

When the Wi-Fi function is switched off, it is not possible to establish a hotspot connection.

- i** Depending on the vehicle equipment, you can purchase a data package directly from a mobile phone network provider via the Mercedes me Store. To be able to use the data package, you conclude a separate contract with a mobile phone network provider via the Mercedes me Store, which can be terminated at any time and for which there are no costs. This contract is a prerequisite for using the services from the previously purchased package. The availability of this option is dependent on the country. If the data package option is not available or can be upgraded, you can purchase data volume directly from the mobile phone network provider for a fee.
- i** The use of the vehicle data tariff by external devices is not available in all countries.

Using the multimedia system as a Wi-Fi hotspot

- ▶ Select **MBUX Hotspot**.
- ▶ Select one of the following connection options.

Connecting using a QR code

Requirement: an app for scanning the QR code is installed on the device being connected.

Alternatively: the device being connected has an integrated QR code scanner (see manufacturer's operating instructions).

- ▶ Scan the QR code shown.
- ▶ The Wi-Fi connection is established.

Connecting using NFC

- ▶ Activate NFC on the device to be connected.
- ▶ When the NFC symbol is displayed in the **MBUX Hotspot** menu, hold the device to be connected to the NFC interface.
- ▶ Follow the instructions on the device.
- ▶ The Wi-Fi connection is established.

Connecting using a security key

- ▶ Select the vehicle from the device to be connected. The vehicle is displayed with the **MBUX XXXXX** network name.
- ▶ Enter the security key which is shown in the central display on the device to be connected.
- ▶ Confirm the entry.

Generating a new security key

- ▶ Select the **Generate New Security Key** option in the **MBUX Hotspot** menu.
- ▶ Confirm the prompt with **Yes**.
- ▶ A new security key is generated.

A connection will be established with the newly created security key.

- i** When a new security key is generated, all existing Wi-Fi connections are then disconnected. If the Wi-Fi connections are being re-established, the new security key must be entered.

Using a mobile communication device as a Wi-Fi hotspot (tethering)

- i** This function is country-dependent.
- ▶ Select the **Manage Internet Access** option in the **Internet and Bluetooth** menu.
- i** The Wi-Fi function on the mobile phone and Internet access via Wi-Fi must be activated (see the manufacturer's operating instructions).
- ▶ Select **Search for Access**.

- ▶ Select the network.
 - ▶ Log in to the Wi-Fi network.
- or
- ▶ Select the mobile phone with the  Wi-Fi symbol.
- i** With external Wi-Fi hotspots, which are encrypted via TKIP, online software updates cannot be carried out via the external Wi-Fi hotspot.

System language

Notes on the system language

This function allows you to determine the language for the menu displays and the navigation announcements. The selected language affects the characters available for entry. The navigation announcements are not available in all languages. If a language is not available, the navigation announcements will be in English.

Setting the language

Multimedia system:

 ▶▶ Settings ▶▶ System
▶▶ Language

Setting the system language

A list of the available system languages is shown.

- ▶ Select a language.
The system language is switched to the selected language.

Resetting the multimedia system (reset function)

⚠ WARNING Risk of accident due to failure of central display functions

While the multimedia system is reset, its functions, such as the rear view camera, are not available.

- ▶ Only reset the multimedia system when the vehicle is stationary.

Requirements

- The vehicle is switched on.

- Some settings can only be reset when the vehicle is stationary.

Multimedia system:

 ▶▶ Settings ▶▶ System ▶▶ Reset

When resetting the system, personal data and settings are deleted, for example:

- Connected devices
- Individual user profiles
- Biometric data
- Vehicles with rear telephony: handset connection

i The data used and saved in the multimedia system by the driver assistance systems is deleted.

i Vehicles with rear telephony: The handset must be in the cradle while the system is reset.

- ▶ Select **Reset**.

A query appears asking if the system should really be reset.

- ▶ Select **Yes**.
The multimedia system is reset to the factory settings. The multimedia system is restarted after the system reset.
- ⓘ Due to data protection, as well as the function of individual driving systems and driving safety systems, it is a requirement to carry out a complete system reset before selling the vehicle or transferring it to a third party, or after use as a hire car.

AMG TRACK PACE

Function of AMG TRACK PACE

- ⓘ This function is an on-demand feature and can be activated via Mercedes me after you purchase your vehicle. The Digital Operator's Manual contains further information on Mercedes me and on-demand features.

With AMG TRACK PACE, the driving characteristics on race tracks can be analyzed and optimized. You can drive previously saved race tracks (e.g. Hockenheimring), or record and save new tracks. The driven lap times are stored for every

track. These can be analyzed and compared to other lap times to achieve the best possible race results. Additionally, acceleration and braking procedures can be measured and stored.



Note: Use AMG TRACK PACE only on closed-off routes outside the public traffic area. Adapt your driving style to your personal performance and environmental conditions. As the driver, you are solely responsible for driving your vehicle. Park your vehicle safely before operating the application.

Setting Track Race



Multimedia system:

↳ TRACK PACE ▶ Track Race

Recording a new track

- ▶ Select  **New Track** .
- ▶ Select  **Start Record**. at the desired starting point.
The track recording starts at this point.



During track recording, sectors can be set to divide up the track.

- ▶  Select **Set Sector**.
- ▶ Select  **Stop Recording** to end track recording or cross the starting line again.
- ▶ Confirm the prompt with **Yes**.
- ▶ Select the weather.
- ⓘ The temperature is determined automatically.
- ▶ Enter a name.
- ▶ Press  to confirm.
The track is saved under the name entered.

Searching by track name

- ▶ Select  **Search** .
- ▶ Enter the track name.
Tracks with the searched name are displayed.



Measuring time on a saved track

- ▶  Select **All tracks**.
- ▶ Select the desired track.
- ▶ Select .
- ▶ Select **Start Time Recording** if you are already at the starting line.

or

- ▶ Select **Navigate to** for navigation to the starting line.

Timing begins automatically when the starting line has been crossed.



- ① When  is selected, the track display can be switched to AR. In addition, it is possible to switch to the telemetry display by selecting .

- ▶ Select  **Stop timekeeping** to end timekeeping.
- ▶ Confirm the prompt with **OK**.
- ▶ Select the weather.
- ▶ Select **Yes** to save the times driven for this track.

Showing readings during Track Race



The following readings can be shown:

- Tire temperature
- Miniature map
- Sector overview
- Engine data
- G-force display

- Lap overview
- ▶ Select  **Start Time Recording**.
- ▶ Select .

By selecting  on the active display, you can deactivate this.

Displaying the analysis

- ▶  Select **All tracks**.
An overview of all the driven tracks appears.
- ▶ Select a track.
- ▶ Select a session.
The following data are displayed:
 - Lap and sector times
 - Average and top speed
 - Driver
 - Vehicle
 - Date
 - Weather
- ▶ Select **Add Recording** to use a different session as a reference value.
- ▶ Select  to return to the overview.



- ▶ Select **Diagram**.
- ▶ Set the desired parameters.
The analysis is displayed.

① The following values can be set for the parameters, for example:



- Speed
- Longitudinal/lateral acceleration
- Steering angle
- Engine speed
- Engine oil/tire temperature

Based on the analysis, you can check and optimize the driving behavior for any position on the track.

Exporting tracks (USB)

- ▶ Select  **Tracks**.
An overview of all stored tracks appears.
- ▶ Select the desired track.
- ▶ Select options  for the desired track.
- ▶ Select **Export Track to...**
The selected track can be exported to a USB storage device connected to the vehicle.

Editing tracks and recordings

- ▶ Select  **Tracks**.
- ▶ Select the desired track.
- ▶ Select options  for the desired track.
- ▶ Select **Rename** or **Delete**.

or

- ▶ Select a track.
- ▶ Highlight the desired recording.
- ▶ Select  options.
- ▶ Select **Export to...** or **Delete**.

Setting Drag Race

Multimedia system:

↳ **TRACK PACE** ▶ **Drag Race**

Measuring acceleration

- ▶ Select  **Drag race options**.
- ▶ Select **Acceleration**.
- ▶ Set a starting speed or select **Automatic**.
Measurement begins as soon as the specified starting speed has been reached.

- ▶ Set a target speed.
Measurement stops as soon as the specified target speed has been reached.
- ▶ Start off and begin the measurement.
Measurement begins when the vehicle accelerates.

Measurement can be stopped early by interrupting the acceleration procedure.

Quarter mile race

- ▶ Select  **Drag race options**.
- ▶ Select **Quarter Mile**.
- ▶ Set a target distance.
Measurement stops as soon as the specified target distance has been reached.
- ▶ Start off and begin the measurement.
Measurement begins when the vehicle accelerates. Timing runs until the target distance or a maximum of one mile has been traveled.

Measurement can be stopped early by interrupting the acceleration procedure.

Measuring braking

- ▶  **Drag Race options**
- ▶ Select **Braking**.
- ▶ Set a starting speed or select **Automatic**.
- ▶ Start off and begin the measurement.
- ▶ Brake to a stop.
Measurement is incremental, in steps of 6 mph (10 km/h) to a stop. If the braking procedure is started e.g. at a speed of 98 mph (157 km/h), measurement starts as soon as 93 mph (150 km/h) has been reached

Storing and calling up measured values

If measurement is completed or canceled, a prompt appears asking whether the measurement should be saved.

- ▶ Confirm the prompt with **OK** to save.

Calling up saved measurements

- ▶  Select **History**.
- ▶ Select **Acceleration**, **Quarter Mile** or **Braking**.
- ▶ Select a measurement.
The desired measurement is displayed in detail.

or

- ▶ Delete a measurement.

Calling up the telemetry display

Multimedia system:

↳ TRACK PACE ▶▶ Telemetry

The telemetry display shows current vehicle data as a digital value and as a diagram. Up to four parameters can be selected to be shown on the display.

For example:

- Engine speed
- Wheel angle
- Speed
- Steering angle

- ▶ Set the desired parameters.

- ▶ Set the time.

The set parameters are evaluated in the diagram for the selected time.

Configuring AMG TRACK PACE

Requirements

To connect a mobile device to the TRACK PACE app:

- The TRACK PACE app is installed on the mobile end device.
- The mobile end device is connected to the multimedia system via Wi-Fi.

Multimedia system:

↳ TRACK PACE ▶▶ 

Connect mobile device via the TRACK PACE app

The TRACK PACE app makes it possible to record videos and to synchronize them with stored tracks.

- ▶ Select **TRACK PACE App**.
- ▶ Select **Authorize a New Device**.
- ▶ Start the TRACK PACE app on the device to be connected.
- ▶ Enter the code on the smartphone.
The device is authorized.

De-authorizing the mobile device

- ▶ Select **TRACK PACE App**.
- ▶ Select a device.
- ▶ Confirm the message prompt with Yes.
The device is de-authorized.

Setting the TRACK PACE display on the head-up display and driver's display

- ▶ Select **IC and HUD Contents**.
- ▶ Activate or deactivate the desired contents.
The contents on the head-up display and the driver's display are adapted.

 For further information on the Head-up Display (→ page 312).

 Further information about the driver's display (→ page 309).

Setting acoustic feedback

- ▶ Select **Acoustic Feedback**.
A scale with values from 0 to 10 is shown.
- ▶ Select a setting.

Displaying statistics

- ▶ Select **TRACK PACE Statistics**. Statistics on the current user profile are displayed.

The following data are displayed:

- Driving time
- Track driven
- Recorded tracks
- Recorded Track Races
- Laps recorded
- Recorded Drag Races
- Maximum design speed

Activating the ambient light

If this function is active, the vehicle interior is lit in red or green depending on delta time.

- ▶ Select **Ambient Light**.
- ▶ Activate or deactivate the function.

Adjusting the dashcam

If the vehicle is equipped with a dashcam, it can be used in AMG TRACK PACE.

- ▶ Select **Dashcam**.
- ▶ Select **Track Race** or **Drag Race** and activate **Activate Recording**.
- ▶ You can set which overlay is to be used in the recorded video under **Video Overlay Content**.

Drive system settings

Calling up the energy flow display

Multimedia system:



- ▶ Select **Energy Flow**. The energy flow in the vehicle will be displayed.

Overview of the energy flow display in the multimedia system

The active components of the drive system are highlighted on the energy flow display. The energy flow between the individual components is shown in color.

The components displayed are:

- State of charge of the high-voltage battery
- Electric motors (drive system)
- Energy flow
- High-voltage battery

The energy flow is shown in different colors depending on the operating status:

- **White:** strong acceleration (boost effect)
- **Copper:** driving at constant speed or with moderate acceleration
- **Blue:** recuperation (charging the high-voltage battery) or overrun mode

Off-road menu

Off-road menu overview in the multimedia system

The **Off-road** menu provides an overview of the most important, relevant data for off-road driving. The content is displayed in different tiles that can be changed with directional arrows or swipes. In addition, this menu contains buttons for quick-access to certain off-road functions.

Displayed data are, for example:

- Artificial horizon
- Compass
- Altitude
- Steering angle of the front and rear wheels
- Torque and power
- Tire pressure and temperature

In the **Off-road** menu you can continue to make settings for Off-road Assist and the Offroad Score.

Setting the off-road menu in the multimedia system

Multimedia system:



Setting displays in the central display

- ▶ Press , or on the display itself to jump to the next display.

Activating/deactivating Parking Assist PARKTRONIC

- ▶ Press to switch the function on or off.

- ⓘ Further information on Parking Assist PARKTRONIC (→ page 280).

Activating / deactivating ESP® (Electronic Stability Program)

- ▶ Press to switch the function on or off.
- ⓘ Further information on ESP (→ page 228).

Activating or deactivating manual gear changing

- ▶ Press to switch the function on or off.
- ⓘ Additional information on manual shifting .

Activating or deactivating DSR (Downhill Speed Regulation)

- ▶ Press to switch the function on or off.
- ⓘ Further information on DSR (→ page 244).

Setting the vehicle level

- ▶ Press to raise or lower the vehicle.
- ⓘ Additional information about vehicle level (→ page 270).
- ⓘ The availability of individual functions depends on the country and equipment.

Navigation and traffic

Notes on navigation

Route guidance with augmented reality

- ⚠ **WARNING** Risk of accident and injury as a result of distraction, incorrect depiction or wrong interpretation of the display

The camera image of the augmented reality display is not suitable as a guide for driving.

- ▶ Always keep an eye on the actual traffic situation.
- ▶ Avoid extended observation of the camera image.

- ⚠ **WARNING** Risk of accident and injury due to imprecise positioning of additional information

The additional information from the augmented reality display may be inaccurate and is not a substitute for observing and assessing the actual driving situation.

- ▶ Always keep an eye on the actual traffic situation when carrying out all driving maneuvers.

Switching navigation on

Multimedia system:



- ▶ Alternatively, press the  button on the steering wheel on the right (→ page 323). The zero layer with the digital map is displayed.





Navigation overview

Digital map and user-specific applications



- Navigation module (reduced view) or EQ module (reduced view)
Route guidance active:
Reduced view of the navigation module shows information relevant to the route, e.g. the next charging stop, the destination and a traffic delay
 Ends the current route guidance
Tapping opens the navigation module in the expanded view with the [Route](#)
Route guidance not active:

EQ module is shown in the reduced view
Tapping opens the EQ module in the expanded view with the charging functions

- Destination entry
- Calls up the Control Center in the status line
- Current vehicle position (vehicle symbol or arrow)
- Display area with entertainment sources, phone, active applications and suggestions
- Searches for POIs, e.g. charging stations  and parking facilities , as well as setting map orientation and map type
- Navigation window shows the next driving maneuver (zoomed out view) or the route monitor (zoomed in view)
For example, with active route guidance, route sections of the route list, representations of upcoming driving maneuvers, lane recommendations
 Switches off navigation announcements
 Switches on navigation announcements

The following map orientations  are available:

- 2D and to the north

- 2D and direction of travel
- 3D and direction of travel
- Map with complete route

i If the map is moved, the map switches between 3D direction of travel and 2D north orientation.

The following map types **6** are available:

- Daytime display
- Night-time display
- Satellite map

i If you notice a problem with the digital map you can report this under <https://mapfeedback.here.com/#/report>.

Navigation module (expanded view)

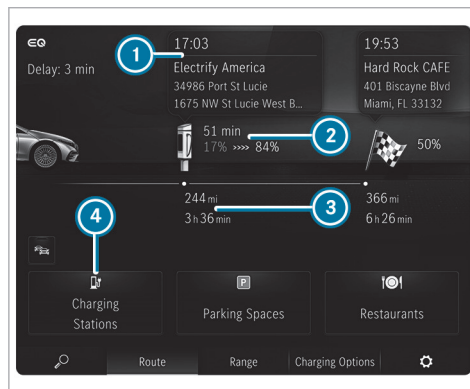

- 1** Arrival time at charging stop, type of charging station
- 2** Charging stop shows the charging time recommended by the Navigation with Electric Intelligence as well as states of charge on arrival and onward journey for an optimal travel time

- 3** Distance from current vehicle position and remaining driving time
- 4** Searches for an additional charging station

EQ module (expanded view)

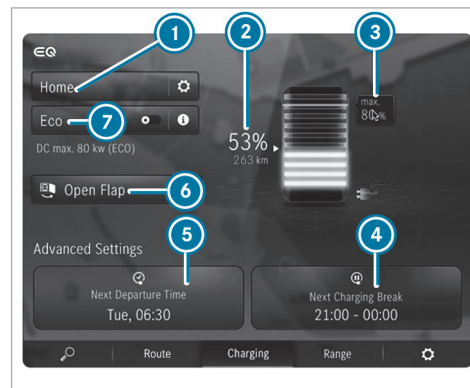

- 1** Sets the charging program (→ page 216)
- 2** Current state of charge of the high-voltage battery

- ③ Maximum state of charge (depending on the setting)
- ④ Sets the next charging break (to use a less expensive tariff)
- ⑤ Sets the departure time
- ⑥ Opens the socket flap
- ⑦ Activates or deactivates ECO charging

Overview of the toll system

- ⓘ The toll system is optional equipment and is not available in all vehicles.

Debiting of toll charges at freeway toll gates is facilitated with an electronic payment system.

The toll system uses RFID (Radio Frequency Identification) for data transfer between the control unit and the toll station.

The toll system is initially switched off at the factory.

The control unit is in the vehicle glove box.

In order to be able to use the toll system, it must have been registered by the customer and activated by the service provider:

- Activate the toll system in the settings of the MBUX multimedia system or on the control unit.
- There are two ways to register and activate:
 - In the Mercedes me App, register the unit identification number of the control unit and activate the toll system.
 - Alternatively, you can register and activate via the [Toll Service](#) app.

Activation of the toll system can take up to 48 hours after registration.

When the toll system is activated, the automatic detection of the number of vehicle occupants is initially switched off at the factory. The number of vehicle occupants is preset with one person.

In order to use the toll system, the device in the glove box or in the MBUX multimedia system must be switched on.

The following applies for roads on which toll charges are dependent on the number of vehicle occupants:

- If the automatic detection of the number of vehicle occupants is switched off, the number of vehicle occupants must be selected manually. This ensures correct toll accounting.
- The number of vehicle occupants can be transmitted automatically. In the process, the number of seat belts worn is determined.

If the number of detected persons does not correspond with the number of persons actually in the vehicle, the number of persons must be manually selected.

The standard setting of one person does not need to be changed for roads which require toll payment regardless of the number of vehicle occupants.

The toll system enables the payment of toll charges in many states of the USA.

- ⓘ In Mexico, for example, the toll system can be registered and activated for journeys to the USA.

Notes on use

- You can only use the toll system once registration and activation are complete.
- Drive at the prescribed vehicle speed in the toll lane.
- Mercedes-Benz recommends operation using the MBUX multimedia system. Alternatively, this can also be done on the control unit in the glove box.
- For safety reasons, entries should be made while the vehicle is stationary.
- For further information, please consult the Mercedes me App or an authorized Mercedes-Benz Center.
Or call 1-800-FOR-MERCEdes (in the USA) or 1-800-387-0100 (in Canada).

For information on how to register and activate the toll system, see the Digital Operator's Manual.

Destination entry**Requirements:**

- **For online search:** an Internet connection is established.
- Mercedes me connect is available.
- You have set up a user account in the Mercedes me Portal.
- The vehicle is connected with the user account and you have accepted the terms of use.
Further information can be found at: <https://www.mercedes.me>
- The service is available.
- The service has been activated at an authorized Mercedes-Benz Center.

Multimedia system:

➔ 🏠 ➔ 🔍 Where to?



Example: entering a POI or address

- 1 Input line
- 2 POI search
- 3 Selects destination search, displays further destination searches with double arrow
- 4 Deletes the last character entered

- ⑤ Hides the keypad
- ⑥ Switches to handwriting recognition
- ⑦ Starts the MBUX voice assistant
- ⑧ Sets the written language
- ⑨ Switches to digits and special characters
- ⑩ Switches to upper-case or lower-case letters

▶ Enter the destination in ①. The entries can be made in any order.
The search results are displayed in a list.

① Online search results for POIs may contain additional information, for example opening times and prices. The information is provided by an online map service.
This online function is not available in all countries.

① You can enter a destination as a three-word address from what3words. This option is not available in all countries.

▶ Hide the keyboard with .

▶ Select the destination in the list.
The route is calculated.

① Observe the notes on the MBUX multimedia system (→ page 315).

Calculating a route with Electric Intelligence and using settings for route guidance

Requirements:

- The destination has been entered.
- The destination address is shown.
- **For Navigation with Electric Intelligence:**
 - Mercedes me connect is available.
 - You have a Mercedes me connect user account and the vehicle is connected with the account.
 - The "Navigation with Electric Intelligence" service is available and activated in the Mercedes me Portal.
The services "Navigation with Electric Intelligence", "Display of charging stations" and "Mercedes me Charge" are required for optimal function.
 - The **Plan Charging Stops** route option is switched on.



Example: detailed display

- ① Saves destination as a favorite (**Plan Charging Stops** is switched on)
Calls up alternative routes (**Plan Charging Stops** is switched off)
- ② Calculates the route and starts route guidance

- ③ Selects a point of interest in the vicinity of the destination
- ④ Destination information, online content (e.g. weather information), three-word address from what3words, saves destination as a favorite, shares destination

After selecting a destination, Electric Intelligence automatically and intelligently calculates the route to the destination. This is updated during route guidance. The route with Electric Intelligence contains the required charging stations as intermediate destinations. The charging stations are determined taking account of the driving distance and the estimated charging times.

- ▶ Select one of the options.
- ① When the **Plan Charging Stops** route option is switched off, a route without charging stations is calculated.

Saving a destination as a favorite

- ▶ Select  **Favorite**.
- ▶ Select an option.

Calling up the route overview

- ① When **Plan Charging Stops** is switched off, this option is available instead of the favorites function.
- ▶ Select **Routes**.
- ▶ Select an alternative route.

Starting route guidance

- ▶ Select  **Let's Go!**.

Calling up the detailed display with destination address

- ▶ Pull the bar above the  **Let's Go!** symbol upwards.
Depending on the destination selection and availability, online content, for example ratings, prices and weather information, is shown.

If the destination is in a different time zone, a message is displayed.

- ▶ **To share a destination:** select  **Share**.
This option allows you to scan the displayed QR code.

- ▶ **To call up an Internet address:** if a web address is available, select **www**.
- ▶ **To call the destination:** if a telephone number is available, select **Call**.

Searching for POIs in the vicinity of the destination shown

- ▶ Select **In The Vicinity**.
- ▶ Search using categories, enter a search entry or search for a personal POI .

Switching on the Electric Intelligence route option

- ▶ Select  in the navigation module (→ page 343).
- ▶ Select **Route**.
- ▶ Activate **Plan Charging Stops**.
If the route has been calculated and the state of charge of the high-voltage battery is not sufficient to reach the destination, charging stations are set automatically as intermediate destinations.

Setting the state of charge of the high-voltage battery when the charging station and destination are reached

- ▶ Select  in the navigation module (→ page 343).
- ▶ Select **Route**.
- ▶ Select **State of Charge at Destination** or **State of Charge at Charging Stations**.
- ▶ Move the control knob to the left or right and set the preferred state of charge in percent (%).
The destination or charging station along the route is reached with the set state of charge.

To reach a charging station, the system uses the battery capacity, e.g. up to 10 % residual energy content (state of charge). You can increase this state of charge on arrival at the charging station and destination, e.g. to 25 % at the charging station and 50 % at the destination.

- ⓘ In the event of increased energy consumption while driving, e.g. with headwind, the following options are available from the system:
 - The charging station is safely reached even at states of charge of less than 10 %.
 - Navigation with Electric Intelligence selects a closer charging station for the route.
- ⓘ If a charging facility is available at the destination, the state of charge can be lowered below 10 %. The **Min.** message appears on the central display. Make sure that the range monitor is switched on.

Selecting a provider for charging stations

- ▶ Select  in the navigation module (→ page 343).
- ▶ Select **Route**.
- ▶ Activate or deactivate **Mercedes me Charge**. If the option is activated, only charging stations payable with Mercedes me Charge are taken into account when selecting the charging station.

or

- ▶ Activate **All**.
All charging stations known to the navigation system are taken into account when calculating routes with Electric Intelligence, regardless of the type of payment.
It may be necessary to register with the provider.

Switching the range monitor on or off

The activated range monitoring assists with messages on the driver and central display to ensure safe arrival at the destination.

- ▶ Select  in the navigation module (→ page 343).
- ▶ Select **Route**.
- ▶ Activate or deactivate **Range Monitor**.
To reach the destination with the state of charge set by the driver, the range is permanently monitored when the option is switched on.
- ⓘ This function is not available in all countries.

Displaying a route overview with charging station

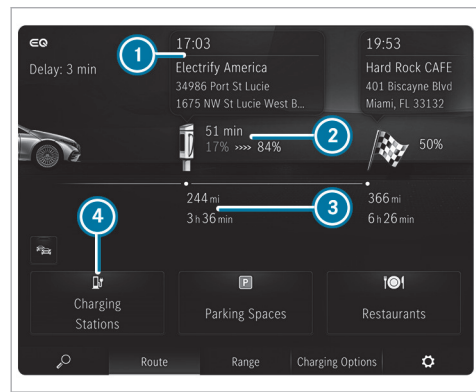

- ① Arrival time at charging stop, type of charging station
- ② Charging stop shows the charging time recommended by the Navigation with Electric Intelligence as well as states of charge on arrival and onward journey for an optimal travel time

- ③ Distance from current vehicle position and remaining driving time
- ④ Searches for an additional charging station

You can influence the route calculated by the Navigation with Electric Intelligence using options ① and ④.

- ▶ Select one of the options.

Ignoring a charging station

If you do not want to drive to the selected charging station, it can be removed for the current route guidance. The Navigation with Electric Intelligence tries to plan the best possible alternative charging station for the route.

- ▶ Select ①.
The expected charging power, the dynamic charge level display as well as the current state of charge and the predicted charging target are displayed, for example.
- ▶ Select **Ignore**.
- ▶ Select **Ignore during this journey**.
The charging station is removed from the current route.

- ⓘ After selecting **Details**, the detailed information about the charging station is displayed.

Adding a charging station

If you want to drive to a charging station on the route earlier than planned, for example, you can search for an additional charging station. If the charging station is suitable for the route, it will be accepted by the Navigation with Electric Intelligence.

- ▶ Select ④.
- ▶ Select a charging station.
- ⓘ You can also search for a charging station using the  symbol on the digital map or next to **Where to?**

Selecting a route type



- ▶ Select  in the navigation module (→ page 343).
- ▶ Select **Route**.
The route is calculated as a fast route with a short journey time. Trailer mode is available if a trailer has been coupled with the vehicle. If available, you can select online routes. Traffic

announcements for the route are taken into account via **Reroute Based on Traffic** .

- ❗ Trailer mode and online routes are not available in all countries and for all vehicles.

Activating a commuter route

- ❗ A user profile has been created and **Allow Destination Suggestions** has been activated in the user options (→ page 329). Route guidance is not active.

- ▶ Select  in the navigation module.
- ▶ Select **Route**.
- ▶ Activate **Activate Commuter Route**.
The navigation system automatically detects that the vehicle is on a commuter route.
For the daily commuter route, traffic events on the route are also reported when driving without active route guidance.
- ▶ **To select or delete a commuter route:**
select **Start** or .

Avoiding or using route sections, e.g. highways or ferries

- ▶ Select  in the navigation module.
- ▶ Select **Route**.
- ▶ Select **Avoid Options**.
- ▶ Activate or deactivate the avoid option.

Activating route guidance with augmented reality

- ▶ Select  in the navigation module.
- ▶ Select **View**.
- ▶ Select **Augmented Reality Video**.
- ▶ Activate or deactivate **Augmented Reality Video**.
The AR camera's video image is shown on the central display before a turning maneuver. The video image includes additional information.

Showing property information for route guidance with augmented reality

Road guidance with augmented reality is activated.

- ▶ Select  in the navigation module.
- ▶ Select **View**.

- ▶ Select **Augmented Reality Video**.
- ▶ Activate **Street Names** and **House Numbers**.
During route guidance, the activated options are shown as additional information in the camera image.

Using map functions

Multimedia system:



Increasing map scale

- ▶ When the map is shown, tap twice quickly with one finger on the central display.

or

- ▶ Move two fingers apart on the central display.

Decreasing map scale

- ▶ Tap with two fingers on the central display.

or

- ▶ Move two fingers together on the central display.

Moving the map

- ▶ When the map is displayed, swipe in any direction with one finger on the central display.
- ▶ **To reset the map to the current vehicle position:** select  **Center**.

Selecting map orientation

- ▶ Tap repeatedly on the  compass symbol on the map.

The map orientation changes in this order:

- The 3D map view is aligned to the direction of travel.
- The 2D map view is aligned to the direction of travel.
- The 2D map view is displayed so that north is always at the top.
- The map shows the complete route.

Using services

Requirements:

- There is an Internet connection.
- Mercedes me connect is available.

- You have set up a user account in the Mercedes me Portal.
- The vehicle is connected to a user account and you have accepted the conditions of use for the service.
Further information can be found at: <https://www.mercedes.me>
- The service is available.
- The service has been activated at an authorized Mercedes-Benz Center.

Multimedia system:



Showing traffic information

- ▶ In the navigation module (expanded view), select  (→ page 343).
- ▶ Select **View**.
- ▶ Activate **Traffic**.
- ▶ Activate **Traffic Incidents** and **Free Flowing Traffic**.
Traffic incidents, for example roadworks, local area reports (e.g. fog) and warning messages, are shown on the route.

The traffic delay is displayed for the current route. The smallest value for the display for traffic delays is a minute.

Displaying hazard warnings

If hazard warnings are available these can be shown as symbols on the map. The display depends on the settings for the **Traffic Incidents** option.

- ▶ In the navigation module (expanded view), select  (→ page 343).
- ▶ Activate or deactivate **Traffic Incidents**.
If the option is activated, all of the symbols are shown.
If the option is deactivated, the symbols are only shown when there is a hazard warning.
The following hazards may be shown on the map:
 - Accidents and breakdowns
 - Slippery roads, fog, crosswinds and heavy rain
 - Hazards reported manually
 - Vehicle with active hazard warning light

- Roadworks
- Additional hazards (if available)

Displaying online map contents

- ▶ In the navigation module (expanded view), select .
- ▶ Select **View**.
- ▶ Switch on an online service, e.g. **Weather**. Current weather information is displayed on the navigation map, e.g. temperature or cloud cover.
The service information is not shown in all map scales, e.g. weather symbols.

Parking service

! **NOTE** Damage to the vehicle due to not observing the maximum permitted headroom clearance

If the vehicle height is greater than the maximum permitted headroom clearance, the roof and other parts of the vehicle may be damaged.

- ▶ Observe the signposted headroom clearance.
- ▶ If the vehicle height is greater than the permitted headroom clearance, do not enter.
- ▶ Observe the changed vehicle height with add-on roof equipment.

! **NOTE** Vehicle damage due to failure to observe local information and parking conditions

The data is based on the information provided by the respective service providers.

Mercedes-Benz does not guarantee the accuracy of the information provided in relation to the car park or parking area.

- ▶ Always observe the local information and conditions.

i This service is not available in all countries.

- ▶ In the navigation module (expanded view), select  and switch on **Parking**.

- ▶ Tap on **P** the map.
or

- ▶ In the route overview, select **P** **Parking Spaces**.
- ▶ Select the search position and search filter, e.g. **Near destination** and **Parking garages**. The map shows car parks suited to the selected settings.
- ▶ Select a parking option.
The map shows the parking options in the vicinity.

The following information is displayed (if available):

- Destination address, distance from current vehicle position and arrival time
- Information on the parking garage/car park

For example, opening times, parking charges, current occupancy, maximum parking time, **maximum access height**.

The maximum access height shown by the parking service does not replace the need

for observation of the actual circumstances.

- Available payment options (Mercedes pay, coins, bank notes, cards)
- Details on parking tariffs
- Number of available parking spaces
- Payment method (e.g. at parking meters)
- Services/facilities at the parking option
- Telephone number

► Calculate the route (→ page 347).

Notes on the dashcam

! **NOTE** Risk of legal consequences due to violation of legal regulations and data protection provisions

You are legally responsible for operation and use of the dashcam functions.

The legal requirements relating to operation and use of the dashcam can vary depending

on the country in which the dashcam is operated.

This function is not permitted in all countries.

- Before using the dashcam, read up on the content of the legal regulations, in particular the data protection requirements in the respective country of use.
- Observe the legal regulations, in particular the data protection requirements.

i Observe the following notes for safe operation:

- Only use FAT32 or exFAT formatted USB storage media.
- Use USB-IF certified USB storage media. The USB-IF is a non-profit society and stands for USB Implementers Forum. Based on the USB specification, the USB-IF certifies e.g. USB versions, corresponding cables and plugs as well as methods for supplying energy via the USB interface.
- Frequent and continuous high-speed overwriting can damage the USB storage

media. Mercedes-Benz recommends a high-quality external SSD drive.

The abbreviation SSD stands for solid-state drive.

i The file size and therefore the duration of single recording is limited by the limitations of the USB flash drive format. So FAT32 formatted USB flash drives do not allow files larger than 4 GB, for example. When the file size is reached, the recording stops and you receive a notification.

i The following functions are available in the Gallery app:

- Switching write protection on or off
- Deleting video files

Selecting a USB device for a video recording with the dashcam

Requirements

- At least one USB device is connected with the multimedia system .

Multimedia system:

→  » Apps » Dashcam

- ▶ Select the USB symbol.
- ▶ Select the USB device.
- ⓘ When USB devices contain multiple partitions, recorded video files are not always displayed in the recording list.
Mercedes-Benz recommends that you use USB devices with one partition.

Starting or stopping video recording with the dashcam

Requirements

- For recording and saving a video file: a USB device is connected with the multimedia system.
- The vehicle is switched on.

Multimedia system:

→  » Apps » Dashcam

- ▶ If several USB devices are connected with the multimedia system, select a USB device (→ page 354).
If no USB device is selected, a selection is made automatically when recording starts.
- ▶ **To select a recording mode:** select **Loop Recording** or **Individual Recording**.
Loop Recording records several short video files. When the memory is full, recording is continued automatically. In doing so, other files will be overwritten starting with the oldest file.
Individual Recording stops recording when the memory limit is reached. An individual recording is automatically protected against being overwritten.
- ▶ **To start:** select **Start Recording**.
The length of the recording is shown. The **Do not remove the storage medium during recording. Before removing the storage medium, eject it first.** message appears. The video file is stored on the USB device.

▶ **To end:** select **End Recording**.

- ⓘ In some countries, geo-coordinates (longitude and latitude) are shown in the video image. For technical reasons, the geo-coordinates may show greater inaccuracies.

A report may appear in the following cases:

- **Individual Recording:** the memory is full or there are only a few minutes recording time available. The video recording stops or will be stopped imminently.
Change the USB device or delete a video file.
- The camera is not functional, the **Camera Unavailable** message appears.
Have the camera checked in an authorized Mercedes-Benz Center.
- If the country border indication has been switched on.
- If an outdoor recording is started with the camera app during a dashcam recording, the dashcam recording pauses and resumes automatically after the camera recording is finished. A notification to this effect is displayed.

Telephone

Telephony

Notes on telephony

⚠ WARNING Risk of distraction from operating integrated communication equipment while the vehicle is in motion

If you operate communication equipment integrated in the vehicle when driving, you could be distracted from the traffic situation. This could also cause you to lose control of the vehicle.

- ▶ Only operate this equipment when the traffic situation permits.
- ▶ If you cannot be sure of this, stop the vehicle whilst paying attention to road and traffic conditions and operate the equipment with the vehicle stationary.

⚠ WARNING Risk of accident from operating mobile communication equipment while the vehicle is in motion

Mobile communication devices distract the driver from the traffic situation. This can also cause the driver to lose control of the vehicle.

- ▶ As a driver, only operate mobile communication devices when the vehicle is stationary.
- ▶ As a vehicle occupant, use mobile communication devices only in the designated area, e.g. in the rear passenger compartment.

You must observe the legal requirements for the country in which you are currently driving when operating the multimedia system and mobile communication equipment in the vehicle.

⚠ WARNING Risk of injury due to objects being stowed incorrectly

If objects in the vehicle interior are stowed incorrectly, they can slide or be thrown around

and hit vehicle occupants. In addition, cup holders, open stowage spaces and mobile phone receptacles cannot always retain all objects within.

There is a risk of injury, particularly in the event of sudden braking or a sudden change in direction.

- ▶ Always stow objects so that they cannot be thrown around in such situations.
- ▶ Always make sure that objects do not protrude from stowage spaces, parcel nets or stowage nets.
- ▶ Close the lockable stowage spaces before starting a journey.
- ▶ Always stow and secure heavy, hard, pointed, sharp-edged, fragile or bulky objects in the trunk/cargo compartment.

Observe the additional information on stowing mobile communications devices correctly:

- Loading the vehicle (→ page 124)

Bluetooth® connection:

The menu view and the available functions in the telephone menu are in part dependent on the Bluetooth® profile of the connected mobile phone. If the mobile phone supports all the following Bluetooth® profiles, the full range of features is available:

- PBAP (Phone Book Access Profile)
 - The contacts on the mobile phone are shown automatically on the multimedia system.
- MAP (Message Access Profile)
 - The mobile phone message functions can be used on the multimedia system.
- HFP (hands-free profile)
 - Wireless telephony is available on the multimedia system.
- SAP (SIM Access Profile)
 - The car telephone has access to the SIM card data and dials into the mobile phone network via the exterior antenna.

Irrespective of this, Bluetooth® audio functionality can be used with any mobile radio unit.

For information on the range of functions of the mobile radio unit to be connected, see the manufacturer's operating instructions.

Network connection:

The following cases can lead to the call being disconnected while the vehicle is in motion:

- You switch into a transmission/reception station, in which no communication channel is free.
- The SIM card used is not compatible with the network available
- A mobile phone with "Twincard" is logged into the network with the second SIM card at the same time

The multimedia system supports calls in HD Voice® for improved speech quality. A requirement for this is that the mobile phone and the mobile phone network provider of the person you are calling support HD Voice®.

Depending on the quality of the connection, the voice quality may fluctuate.

Further information can be obtained from an authorized Mercedes-Benz Center or at: <https://www.mercedes-benz.com/connect>.

Telephone menu overview



- 1 Bluetooth® device name of the currently connected mobile phone/of the mobile phone
- 2 Bluetooth® device name of the currently connected mobile phone/of the mobile phone (two phone mode)
- 3 Signal strength of the mobile phone network
- 4 Battery status of the connected mobile phone

- 5 Options
- 6 Messages
- 7 Calls up devices
- 8 Numerical pad
- 9 Starts contact search

Telephony operating modes overview

Depending on your equipment, the following telephony operating modes are available:

- A mobile phone is connected to the multimedia system via Bluetooth®.
- Two mobile phones are connected with the multimedia system via Bluetooth® (two phone mode).
 - You can use all the functions of the multimedia system with both mobile phones.

Connecting a mobile phone

Requirements

- Bluetooth® is activated on the mobile phone (see the manufacturer's Operator's Manual).
- Bluetooth® is activated on the multimedia system.

Multimedia system:



Searching for a mobile phone

- ▶ Select [Connect New Device](#).

Connecting a mobile phone

- ▶ Select a mobile phone.
A code is displayed in the multimedia system and on the mobile phone.
- ▶ If both codes match, confirm the code on the mobile phone.

Functions in the telephony menu

In the telephony menu you have the following functions, for example:

- Making calls, e.g.:
 - Accepting a call
 - [End Call](#)
 - Answering a call with a message
 - [Conference](#)
 - Accepting or rejecting a waiting call

- Managing contacts, e.g.:
 - Downloading mobile phone contacts
 - Managing the format of a contact's name
 - Deleting favorites
- Receiving and sending messages, e.g.:
 - Using the read-aloud function
 - Dictating a new message

Mercedes me Apps

Mercedes me calls

■ Making a call via the overhead control panel

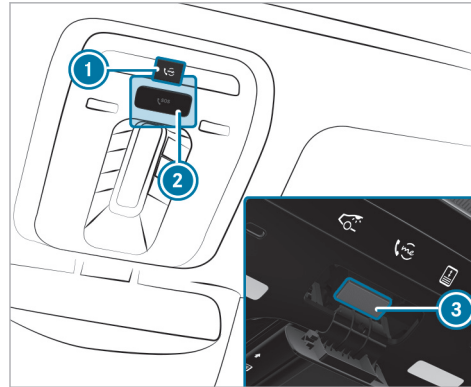

- ① me button for service or information calls
- ② SOS button cover
- ③ SOS button (emergency call system)

Making a Mercedes me call

- ▶ Press me button ①.

Making an emergency call

- ▶ To open the cover of SOS button ②, press it briefly.
- ▶ Press and hold SOS button ③ for at least one second.

If a Mercedes me call is active, an emergency call can still be triggered. This has priority over all other active calls.

■ Information about the Mercedes me call using the me button

A call to the Mercedes-Benz Customer Center has been initiated via the me button in the overhead control panel or the multimedia system (→ page 359).

Using the voice dialog system you access the desired service:

- Accident and Breakdown Management
- Mercedes-Benz Customer Center for general information about the vehicle

You can find information on the following topics:

- Activation of Mercedes me connect
- Operating the vehicle
- Nearest authorized Mercedes-Benz Center
- Other products and services from Mercedes-Benz

Data is transferred during the connection to the Mercedes-Benz Customer Center (→ page 361).

■ Calling the Mercedes-Benz Customer Center using the multimedia system

Requirements

- Access to a GSM network is available.
- The contract partner's GSM network coverage is available in the respective region.
- The vehicle must be switched on so that vehicle data can be transferred automatically.

Multimedia system:



▶ Call Mercedes me connect.

After confirmation, the multimedia system sends the required vehicle data. The data transfer is shown in the display.

Then you can select a service and be connected to a specialist at the Mercedes-Benz Customer Center.

■ Calling the Mercedes-Benz Customer Center after automatic accident or breakdown detection

Requirements

- The vehicle has detected an accident or breakdown situation.
- The vehicle is stationary.
- The hazard warning lights are switched on.

i This function is not available in all countries.

The vehicle can detect accident or breakdown situations under certain circumstances.

Requirements for collision detection in the context of accident management:

- The vehicle is equipped with an anti-theft alarm system (ATA) (code 551).
- The vehicle is equipped with the interior protection (code 882).
- The vehicle is equipped with the Anti-Theft Protection Package (code P54).
- The collision detection service with theft notification has been activated on Mercedes me connect.

If a collision is detected when the tow-away alarm is armed on a locked vehicle, you will receive a notification in the multimedia system when you switch the vehicle on.

The message informs you about the potentially affected area of the vehicle and the strength of the collision.

In the event an accident or breakdown is detected, the emergency guide shows safety notes in the multimedia system display. This may take a few seconds.

- ❗ The availability of collision detection depends on the vehicle.

After quitting the emergency guide display on the multimedia system, a prompt appears asking whether you would like to get support from the Mercedes-Benz Customer Center.

▶ Select **Call**.

- After your agreement, or if the Mercedes me connect service "Accident and Breakdown Management" is active, the vehicle data is transferred automatically (→ page 363).
- The Mercedes-Benz Customer Center takes your call and organizes the breakdown and accident assistance.

You may be charged for these services.

- ❗ Depending on the severity of the accident, an automatic emergency call can be initiated. This has priority over all other active calls (→ page 367).
- ❗ In addition, if the Mercedes me connect service "Telediagnosics" is active, a similar prompt can appear after a delay in the event

of a breakdown. If you are already in contact with the Mercedes-Benz Customer Center or have already received support, this prompt can be ignored or declined.

- ❗ If you answer the prompt for support from the Mercedes-Benz Customer Center with **Call Later**, the message will be hidden and appear again later. The prompt triggered by the Mercedes me connect service "Telediagnosics", can either be confirmed or declined. After being declined, this will not be shown again.

■ Arranging a service appointment via a Mercedes me call

If you have activated the maintenance management service, relevant vehicle data is transferred automatically to the Mercedes-Benz Customer Center. You will then receive individual recommendations regarding the maintenance of your vehicle.

Regardless of whether you have consented to the maintenance management service, the multimedia system reminds you after a certain amount of

time that a service is due. A prompt appears asking if you would like to make an appointment.

▶ **To arrange a service appointment:** select **Call**. After your consent, the vehicle data is transferred and the Mercedes-Benz Customer Center takes your preferred appointment date. The information is then sent to your desired service outlet.

This will contact you to confirm the appointment and if necessary consult about the details.

- ❗ If you select **Call Later** after the service message appears, the message is hidden and reappears at a later time.

■ Data transferred during a Mercedes me call

If you initiate a service call using Mercedes me, data is transferred to enable targeted advice and an efficient service.

The following requirements must be fulfilled for the transfer of the data:

- The vehicle is switched on.
- The required data transfer technology is supported by the mobile phone network provider.

- The quality of the mobile connection is sufficient.

Multi-stage transfer depends on the following factors:

- Reason for the initiation of the call
 - The available mobile phone transmission technology
 - The activated Mercedes me connect services
 - The service selected in the voice control system
- ❗ The scope of the data transmitted depends on the vehicle model and vehicle equipment. For technical reasons, not all data is available at all times.

Data transfer if Mercedes me connect services are not activated

If no Mercedes me connect services are activated, the following data is transferred:

- Vehicle identification number
- Time of the call
- Reason for the initiation of the call

- Confirmation of the data protection prompt
- Country indicator of the vehicle
- Set language for the multimedia system
- Telephone number of the communication platform installed in the vehicle

If a call is made for a service appointment via the service reminder, the following data is also transmitted:

- Current mileage and maintenance data

If a call is made after automatic accident or breakdown detection using the multimedia system, the following data is also transmitted:

- Current mileage and maintenance data
- Current vehicle location

If Accident and Breakdown Management is called via the voice control system, the following data can also be called up from the vehicle by the Mercedes-Benz Customer Center:

- Current vehicle location

Data processing

The data transmitted within the scope of the call is deleted from the processing system after the call is finished, in so far as this data is not being used for other activated Mercedes me connect services.

The incident-specific data is processed and stored in the Mercedes-Benz Customer Center and, if required to process the incident, forwarded to the service partner authorized by the Mercedes-Benz Customer Center. Take note of the data protection information on the Mercedes me Internet page <https://www.mercedes.me> or in the recorded message immediately after calling the Mercedes-Benz Customer Center.

- ❗ The recorded message is not available in every country.

Mercedes me connect

Information on Mercedes me connect

Mercedes me connect consists of multiple services.

You can use the following services via the multimedia system and the overhead control panel, for example:

- Accident and Breakdown Management (me button or situation-dependent display in the multimedia system)
- Mercedes-Benz Emergency Call System (automatic emergency call and SOS button)

The Mercedes me connect Accident and Breakdown Management and the Mercedes-Benz emergency call center are available to you around the clock.

The me button and the SOS button can be found on the vehicle's overhead control panel (→ page 359).

You can also call the Mercedes-Benz Customer Center using the multimedia system (→ page 360).

Please note that Mercedes me connect is a Mercedes-Benz service. In emergencies, first call the national emergency services using the standard national emergency service telephone numbers. In emergencies, you can also use the

Mercedes-Benz emergency call system (→ page 367).

Please note the Mercedes me connect terms of use and the data protection information for Mercedes me connect. You can find these in your Mercedes me user account.

Further information about Mercedes me connect services can be obtained in the Mercedes me Portal: <https://me.secure.mercedes-benz.com>

■ Information on Mercedes me connect Accident and Breakdown Management

- ① Accident and Breakdown Management is not available in every country. Contact an authorized Mercedes-Benz Center to find out whether this function is available in your country.

The Accident and Breakdown Management can include the following functions:

- Supplement to the Mercedes-Benz emergency call system (→ page 367)
If necessary, the contact person at the Mercedes-Benz emergency call center forwards the call to Mercedes me connect Acci-

dent and Breakdown Management. Forwarding the call is however not possible in all countries.

- Breakdown assistance by a technician on location and/or the towing away of the vehicle to the nearest authorized Mercedes-Benz Center
You may be charged for these services.
- Addition to the emergency guide after automatic accident or breakdown detection (→ page 360)
In the event of a breakdown or accident, further vehicle data is sent which enables optimal support by the Mercedes-Benz Customer Center and the authorized service partner or breakdown assistance.
- Addition to the Mercedes me connect service Telediagnosics
With the Telediagnosics function, specific wear and failure reports are recorded by the service provider, in so far as these can be clearly interpreted and are available through the monitoring of components that are subject to diagnostics.

If your vehicle detects a breakdown or threat of a breakdown, you may be prompted via the multimedia system to contact the Mercedes-Benz Customer Center for further help. This prompt in the multimedia system only appears when the vehicle is stationary.

- ⓘ These services are subject to technical restrictions such as the mobile phone coverage, mobile network quality and the ability of the processing systems to interpret the transferred data. In some circumstances, this can result in delays or the failure of the information to appear in the multimedia system.

Please note that the service and breakdown call is a Mercedes-Benz service. In emergencies, be sure to contact the usual national emergency number first or use the Mercedes-Benz emergency call system (→ page 366).

More information about Mercedes me connect services can be obtained in the Mercedes me Portal: <https://me.secure.mercedes-benz.com>

■ Data transferred during Mercedes me connect call services

The data transferred during a Mercedes me connect call depends on:

- The reason for initiation of the call
- The service that is selected in the voice control system
- The activated Mercedes me connect services

You can find out which data is transferred when using the services in the currently valid Mercedes me connect terms of use and the data protection information for Mercedes me connect. You can find these in your Mercedes me user account.

Overview of the Mercedes me & Apps menu

When you log in with a user account to the Mercedes me Portal, then services and offers from Mercedes-Benz will be available to you.

For more information consult an authorized Mercedes-Benz Center or visit the Mercedes me Portal: <https://me.secure.mercedes-benz.com>

- ⓘ Make sure you always keep the Mercedes me Apps updated.

You can call up the menu using **Apps** in the multimedia system.

In the **Apps** menu, the following options can be available:

- Connecting the vehicle with the **Mercedes me** user account
- Deleting a connection between a user account **Mercedes me** and the vehicle
- Calling up the Mercedes me services
- Calling up apps such as In-Car Office or the web browser depending on availability

Web browser overview



- ① Previous website
- ② Next website
- ③ Update
- ④ URL
- ⑤ Adds/removes bookmarks
- ⑥ Options
- ⑦ Settings

① Under ... you have the following options:

- [Tabs](#)
 - [Bookmarks & History](#)
 - [Reading Mode](#)
 - [Share Link](#)
 - [Share Content](#)
 - [Request Mobile Website](#)
- ① Websites cannot be shown while the vehicle is in motion.

Overview of Smartphone Integration

With Smartphone Integration, you can use certain functions on your mobile phone via the multimedia system display.

Only one mobile phone at a time can be connected via Smartphone Integration to the multimedia system. Also for use with two phone mode with Smartphone Integration, only one additional mobile phone can be connected using Bluetooth® with the multimedia system.

The full range of functions for Smartphone Integration is only possible with an internet connec-

tion. The appropriate application must be downloaded on the mobile phone to use Smartphone Integration. The mobile phone must be switched on and connected to the multimedia system via the USB port using a suitable cable.

Apps for Smartphone Integration:

- Apple CarPlay® (wireless connection via Bluetooth® also possible)
- Android Auto (wireless connection via Bluetooth® also possible)

① For safety reasons, the first activation of Apple CarPlay® or Android Auto on the multimedia system must be carried out when the vehicle is stationary with the parking brake.

You can start Smartphone Integration using the [Devices](#) menu.

You can end Smartphone Integration via the [Devices](#) or by disconnecting the connecting cable between the mobile phone and multimedia system.

- ⓘ Mercedes-Benz recommends disconnecting the connection via the device manager or the connecting cable only when the vehicle is stationary.

Overview of transferred vehicle data

When using Smartphone Integration, certain vehicle data is transferred to the mobile phone. This enables you to get the best out of selected mobile phone services. Vehicle data is not directly accessible.

The following system information is transmitted:

- Software release of the multimedia system
- System ID (anonymized)

The transfer of this data is used to optimize communication between the vehicle and the mobile phone.

To do this, and to assign several vehicles to the mobile phone, a vehicle identifier is randomly generated.

This has no connection to the vehicle identification number (VIN) and is deleted when the multimedia system is reset (→ page 336).

The following driving status data is transmitted:

- Transmission position engaged
- Distinction between parked, standstill, rolling and driving
- Day/night mode of the driver's display
- Drive type

The transfer of this data is used to alter how content is displayed to correspond to the driving situation.

The following position data is transmitted:

- Coordinates
- Speed
- Compass direction
- Acceleration direction

The mobile phone uses this data to improve the accuracy of navigation, for example, when driving through a tunnel.

Mercedes-Benz emergency call system

Information on the Mercedes-Benz emergency call system

Your vehicle is equipped with the Mercedes-Benz emergency call system ("eCall"). This feature can help save lives in the event of an accident. eCall in no way replaces assistance provided from dialing 911.

Mercedes-Benz eCall only functions in areas where mobile phone coverage is available from the wireless service providers. Insufficient network coverage from the wireless service providers may result in an emergency call not being transmitted.

eCall is a standard feature in your Mercedes-Benz vehicle. In order to function as intended, the system relies on the transmission of data detailed in the Transmitted Data section that follows.

To disable eCall, a customer must visit an authorized Mercedes-Benz Service department to deactivate the vehicle's communication module.

Deactivation of this module prevents the activation of any and all Mercedes me connect serv-

ices. After the deactivation of eCall, automatic emergency call and manual emergency call will not be available.

The vehicle must be switched on before an automatic emergency call can be made.

- ❶ eCall is activated at the factory.
- ❷ eCall can be deactivated by an authorized Mercedes-Benz dealer. Please note that in the event ownership of the vehicle is transferred to another owner in its deactivated state, eCall will remain deactivated unless the new owner visits an authorized Mercedes-Benz dealership to reactivate the system.

Overview of the Mercedes-Benz emergency call system

eCall can help to reduce the time between an accident and the arrival of emergency services at the site of the accident. It helps locate an accident site in places that are difficult to access. However, even if a vehicle is equipped with eCall, this does not mean the system is ON. As such, eCall does not replace dialing 911 in the event of an accident.

An emergency call can be made automatically or manually.

Only make emergency calls if you or others are in need of rescue. Do not make an emergency call in the event of a breakdown or a similar situation.

Messages on the display

SOS NOT READY: the vehicle is not on or eCall not available.

During an active emergency call, <schar> appears in the display.

You can find more information on the regional availability of eCall at: <https://www.mercedes-benz-mobile.com/extra/ecall/>

- ❶ If there is a malfunction of the emergency call system, the loudspeakers, microphone, air bag or the SOS button, for example, are faulty.

You can recognize a malfunction in the emergency call system by the following displays:

- A corresponding message will also appear in the driver's display.
- The SOS button lights up red continuously.

Triggering an automatic Mercedes-Benz emergency call

Requirements:

- The vehicle is switched on.
- The starter battery is sufficiently charged.

The Mercedes-Benz emergency call system triggers an emergency call automatically in the following cases:

- After activation of the restraint systems such as air bags or Emergency Tensioning Devices after an accident
- After an automatically initiated emergency stop by Active Emergency Stop Assist

The emergency call has been made:

- A voice connection is made to the Mercedes-Benz emergency call center.
- A message with accident data is transmitted to the Mercedes-Benz emergency call center.

The Mercedes-Benz emergency call center can transmit the vehicle position data to one of the emergency call centers.

The SOS button in the overhead control panel flashes until the emergency call is finished.

It is not possible to immediately end an automatic emergency call.

If no connection can be made to the emergency services either, a corresponding message appears in the media display.

- ▶ Dial the local emergency number on your mobile phone.

If an emergency call has been initiated:

- Remain in the vehicle if the road and traffic conditions permit you to do so until a voice connection is established with the emergency call center operator.
- Based on the call, the operator decides whether it is necessary to call rescue teams and/or the police to the accident site.
- If no vehicle occupant answers, an ambulance is sent to the vehicle immediately.

Triggering a manual Mercedes-Benz emergency call

- ▶ **To use the SOS button in the overhead control panel:** press the SOS button at least one second long (→ page 359).

or

- ▶ **To use voice control:** use the voice commands of the MBUX Voice Assistant.

The emergency call has been made:

- A voice connection is made to the Mercedes-Benz emergency call center.
- A message with accident data is transmitted to the Mercedes-Benz emergency call center. The Mercedes-Benz emergency call center can transmit the vehicle position data to one of the emergency call centers.
- Remain in the vehicle if the road and traffic conditions permit you to do so until a voice connection is established with the emergency call center operator.
- Based on the call, the operator decides whether it is necessary to call rescue teams and/or the police to the accident site.

If no connection can be made to the emergency services, a corresponding message appears in the central display.

- ▶ Dial the local emergency number on your mobile phone.

Ending an unintentionally triggered manual Mercedes-Benz emergency call

- ▶ Select <schar> on the multifunction steering wheel. Depress button for several seconds.

Data transfer of the Mercedes-Benz emergency call system

In the event of an automatic or manual emergency call the following data is transmitted, for example:

- Vehicle's GPS position data
- GPS position data on the route (a few hundred meters () before the incident)
- Direction of travel
- Vehicle identification number
- Vehicle drive type
- Number of people detected in the vehicle

- Whether Mercedes me connect is available or not
- Whether the emergency call was initiated manually or automatically
- Time of the accident
- Language setting on the multimedia system

Data transmitted is vehicle information. For any questions about the collection, use and sharing of the eCall system data, please contact MBUSA's Customer Assistance Center at 800-FOR-MERC.

For Canada, please contact MBC's Customer Assistance Center at 1-800-387-0100.









Customer requests for covered information should be submitted via the same channels.





For accident clarification purposes, the following measures can be taken up to an hour after the emergency call has been initiated:

- The current vehicle position can be determined.
- A voice connection to the vehicle occupants can be established.

Radio & media

Overview of the symbols and functions in the media menu







Symbol	Designation	Function
	Play	Select to start or continue playback.
	Rest	Select to pause the playback.
	Repeat a track	Select to repeat the current track or the active playlist. <ul style="list-style-type: none"> • Select once: the active playlist is repeated. • Select twice: the current track is repeated. • Select three times: the function is deactivated.
	Random playback	Select to play back the tracks in random order.
	Skip forwards/back	Select to skip to the next or to the previous track.
	Additional options	Select to show additional options.
	Categories	Select in order to display or search through the available categories such as playlists, albums or artists.
	Search	Select to search in the active menu. You can search for artists, genres or moods, for example.

Symbol	Designation	Function
	Settings	Select to make settings.
	Home	Select to return to the home screen.
	Messaging	Select to call up messaging.
	Full screen	Select to switch to full screen mode.

The following functions and settings are available in the [Media](#) menu:





- Connecting external data storage media with the multimedia system (e.g. using USB or Bluetooth®)
- Playing back audio or video files

Overview of the symbols and functions in the radio menu

Symbol	Designation	Function
	Home	Select to return to the home screen.
	Messaging	Select to call up messaging.
	Skip forwards/back	Select to skip to the next or to the previous station.
	Settings	Select to have further options shown. The setting options are country-dependent.
HD	HD Radio™	Select to switch the HD Radio™ function on or off. This function is not available in all countries.
	Station list	Select to have the station list shown.
	Search	Select to search in the active menu. You can search for artists, genres or moods, for example.

Additional functions of TuneIn Radio

-  A relatively large volume of data can be transmitted when using TuneIn Radio.

Symbol	Designation	Function
	Settings	The following additional settings are available in the TuneIn Radio menu: <ul style="list-style-type: none"> • Selecting stream • Logging on to or out of the TuneIn account
	Favorites	Select during playback to save the station currently set as a favorite.
	Play/Pause	Select to start, stop or continue playback.
	Browse	Select to choose a category and then a radio station.

Additional functions of the satellite radio

SIRIUS XM[®] satellite radio offers more than 175 digital-quality radio channels providing commercial-free music, sports, news and entertainment, for example. SIRIUS XM[®] satellite radio employs a fleet of high-performance satellites to broadcast

around the clock throughout the USA and Canada. The satellite radio program is available for a monthly fee. Information about this can be obtained from a Sirius XM[®] Service Center and at <https://www.siriusxm.com> (USA).

 Sirius, XM and all related marks and logos are trademarks of Sirius XM Radio Inc. and its subsidiaries. All other marks, channel names

and logos are the property of their respective owners. All rights reserved.

Symbol	Designation	Function
	Settings	The following additional settings are available in the satellite radio menu: <ul style="list-style-type: none"> • Activate child safety lock to lock channels with adult content • Set alarm programming for music and sport alerts • Create TuneMix lists to listen to music seamlessly
	Play	Select to start or continue playback.
	Rest	Select to pause the playback.

Depending on the frequency band selected, different functions are available to you.

Select the desired frequency band in the radio menu head runner.

Calling up TuneIn Radio

Requirements

- There is a user account at <https://www.mercedes.me>.
- The vehicle is linked to the Mercedes me user account.
- The TuneIn Radio service is activated in the Mercedes me portal.

- The data volume is available.
Depending on the country, data volume may need to be purchased.
 - A fast Internet connection for data transmission free of interference.
-  New data volume can be purchased **directly from a mobile phone network provider** via the Mercedes me Portal.

- ⓘ The functions and services are country-dependent. For more information, consult an authorized Mercedes-Benz Center.

Multimedia system:

↳  » Radio

- ▶ Select **TuneIn Radio**.

The TuneIn menu appears. The last station set starts playing.

- ⓘ The connection quality depends on the local mobile phone reception.

Setting up satellite radio

Requirements:

- Satellite radio equipment is available.
- Registration with a satellite radio provider has been completed.
- If registration is not included when purchasing the system, your credit card details will be required to activate your account.

Multimedia system:

↳  »  Radio » SiriusXM
 » 

- ▶ Select **Service Information**.

The service information screen appears showing the radio ID and the current subscription status.

- ▶ Establish a telephone connection.

- ▶ Follow the service staff's instructions. The activation process may take up to ten minutes.

- ⓘ You can also have the satellite service activated online. To do so, please visit <https://www.siriusxm.com> (USA) or <https://www.siriusxm.ca> (Canada).

Music and sport alerts

Multimedia system:

↳  »  Radio » SiriusXM
 »  » Alerts

Setting music and sport alerts

This function enables you to program an alert for your favorite artists, tracks or sporting events. Music alerts can be saved whilst a track is being played and sport alerts can be saved during a live game. You can also specify sport alerts via the menu option. The system then continuously searches through all the channels.

- ▶ Set a music or sports alert, to be informed of matches in the live program.

Activating messages for a category

- ▶ Select a category and activate .

Adding messages for a category

- ▶ Select a category and add a message .
- ▶ Select **Artist Alerts** or **Song Alerts** in the dialog window. The message is set for the activated track and artist. If a match is found, a prompt

appears asking whether you wish to change to the station.

- Automatic adjustment

Deleting messages in a category

▶ Select a category, mark the desired messages and delete .

or

▶ Do not mark any messages and delete all entries .

Sound settings

Overview of functions in the sound menu

The setting options and functions available depend on the sound system installed. You can find out which sound system is installed in your vehicle in the Digital Operator's Manual.

Standard sound system

The following functions are available:

- Equalizer
 - Treble, mid-range and bass
- Balance and fader
- Volume

ASSYST PLUS service interval display

Function of the ASSYST PLUS service interval display

The ASSYST PLUS service interval display on the driver's display informs you of the next regular service due date.

Depending on the operating conditions of the vehicle, the remaining time or distance until the next service due date will be displayed.

You can hide this service display using the  back button on the steering wheel.



You can obtain information concerning the servicing of your vehicle from a qualified specialist workshop, e.g. an authorized Mercedes-Benz Center (→ page 36).

Displaying the service due date

Driver's display:

 Service

The next service due date is displayed.

 **To exit the display:** press the  back button on the steering wheel.

Bear in mind the following related topic:

- Operating the driver's display (→ page 310).

Information on regular maintenance work

 **NOTE** Premature wear through failure to observe service due dates

Maintenance work which is not carried out at the right time or incompletely can lead to increased wear and damage to the vehicle.

- ▶ Adhere to the prescribed service intervals.
- ▶ Always have the prescribed maintenance work carried out at a qualified specialist workshop.

 **NOTE** Irreparable damage to the high-voltage battery due to maintenance work not being carried out

The high-voltage battery is subject to wear. Maintenance work which is not carried out in time can lead to irreparable damage to the high-voltage battery.

- ▶ Always observe the warning messages about the high-voltage battery and immediately consult a qualified specialist workshop.
- ▶ Have the necessary maintenance work on the high-voltage battery carried out at a qualified specialist workshop.

Notes on special service requirements

The prescribed service interval is based on normal operation of the vehicle. Have the maintenance work carried out more often than prescribed if operating conditions are difficult or the vehicle is subject to increased stress. This is the case for frequent operation in mountainous terrain or on poor road surfaces, for example.

In these or similar operating conditions, have the interior air filter changed more frequently. Check the tires more frequently if the vehicle is operated under increased stress. Further information can be obtained at a qualified specialist workshop.

The ASSYST PLUS service interval display is only an aid. It is the responsibility of the driver of the

vehicle to have maintenance work carried out more often than prescribed due to actual operating conditions and/or stresses.

Battery disconnection periods

The ASSYST PLUS service interval display can calculate the service due date only when the battery is connected.

- ▶ Display and note down the service due date on the driver's display before disconnecting the battery (→ page 377).

Maintenance Management

Notes about Maintenance Management

If the Maintenance Management service is activated, relevant data is automatically transferred to the Mercedes-Benz customer center.

The customer center transmits the data to the service partner that you have entered on the Mercedes me website at: <http://www.mercedes.me>. You will then receive individ-

ual recommendations regarding the maintenance of your vehicle.

- ① The calculation of the optimal transmission time of the maintenance request to the service partner is subject to technical limitations that may cause the maintenance recommendation to be perceived as too early or too late or not to be made at all. In this case, you can conveniently arrange a maintenance appointment with the customer center via the maintenance reminder in the multimedia system.
- ① Maintenance Management and the maintenance reminder in the multimedia system are not available in every country. Contact an authorized Mercedes-Benz Center to find out whether this function is available in your country.

Data transferred when using Maintenance Management

When the service is activated, relevant data is automatically transferred to determine the

required scope of maintenance as well as malfunction detection and malfunction rectification.

Details on data transfer can be found in the data protection information for the Mercedes me connect services. These can be found at: <https://www.mercedes.me> under "My Mercedes me account", "Terms of use".

- ① Maintenance Management and the maintenance reminder in the multimedia system are not available in every country.

Telediagnosis

Notes about Telediagnosis

- ① This service is not available in all countries. The vehicle can detect if certain wear parts need to be replaced or if malfunctions have occurred in vehicle systems. If the Telediagnosis service is activated, relevant data is automatically transmitted to the manufacturer. If fault conditions are detected by the vehicle system self-diagnosis, the system transmits recommendations for action to the Mercedes-Benz customer center depending on the fault detected. The customer center trans-

mits the data to the service partner that you have entered on the Mercedes me website at: <http://www.mercedes.me>.

For selected faults, the notification that a malfunction has been detected may appear in the multimedia system with a request to contact the Mercedes-Benz customer center. From this message, a call can be made directly to the customer center for assistance.

- ① The transmission of a notification to the multimedia system depends on the country, vehicle model and equipment and requires a fast data connection, over which the service provider has no influence.
- ① Reliable fault detection is subject to technical limitations. Therefore, only a limited selection of faults can be detected and recommendations for action transmitted to the customer center and the service partners. Mercedes-Benz AG is continuously working on the expansion of this service. The fault detection depends on the country, vehicle model and equipment.

Data transferred when using Telediagnosics

When the service is activated, relevant data is automatically transferred to determine the required scope of maintenance as well as malfunction detection and malfunction rectification.

Details on data transfer can be found in the data protection information for the Mercedes me connect services. These can be found at: <https://www.mercedes.me> under "My Mercedes me account", "Terms of use".

- ① The scope of the data transmitted depends on the vehicle model and equipment. For technical reasons, not all data is available at all times.

Engine compartment

Notes on the hood

Only the specialist personnel of a qualified specialist workshop should open the hood. Access by the customer is not permitted.

To open the hood, consult a qualified specialist workshop.

⚠ DANGER Risk of fatal injuries when carrying out maintenance work during the charging process

During the charging process, the high-voltage on-board electrical system is under high voltage.

- ▶ Do not perform any maintenance work during the charging process.

⚠ WARNING Risk of accident due to driving with the hood unlocked

The hood may open and block your view.

- ▶ Never release the hood when driving.
- ▶ Before every trip, ensure that the hood is locked.

⚠ WARNING Risk of accident and injury when opening and closing the hood

The hood may suddenly drop into the end position.

There is a risk of injury for anyone in the hood's range of movement.

- ▶ Do not open or close the hood if there is a person in the hood's range of movement.

⚠ WARNING Risk of injury due to overheated vehicle

If you open the hood in the event of an overheated vehicle or fire in the engine compartment, the following situations may occur:

- You may come into contact with hot gases.
- You may come into contact with other escaping hot operating fluids.
- ▶ In the event of overheating or fire in the engine compartment, keep the hood closed and call the fire service.
- ▶ Allow the overheated vehicle to cool down first if you need to open the hood.

⚠ WARNING Risk of injury due to moving parts

Components in the engine compartment may continue to run or start unexpectedly even when the drive system is switched off.

Observe the following if you must open the hood:

- ▶ Switch off the vehicle.
- ▶ Never touch the danger zones surrounding moving components, e.g. the rotation area of the fan.
- ▶ Remove jewellery and watches.
- ▶ Keep items of clothing and hair away from moving parts.

⚠ WARNING Risk of injury from using the windshield wipers when the hood is open

If the windshield wipers start moving when the hood is open, you could be trapped by the wiper linkage.

- ▶ Always switch off the windshield wipers and the vehicle first if you need to open the hood.

Notes on the coolant level

Checking or topping up coolant should be carried out only by the trained personnel of a qualified specialist workshop. Access by the customer is not permitted.

To check or top up coolant, use a qualified specialist workshop.

⚠ WARNING Risk of scalding from hot coolant

You may scald yourself if you open the cap when the drive system is at normal operating temperature.

- ▶ Allow the engine to cool down before opening the cap.
- ▶ When opening the cap, wear protective gloves and safety glasses.
- ▶ Open the cap slowly to release pressure.

Keeping the air/water duct free

- ▶ Keep the area between the hood and the windshield free of deposits, e.g. ice, snow or leaves.

Filling the windshield washer system

⚠ WARNING Risk of fire and injury from windshield washer concentrate

Windshield washer concentrate is highly flammable.

- ▶ Avoid fire, open flames, smoking and the creation of sparks when using windshield washer concentrate.

Requirements

- The vehicle is unlocked.

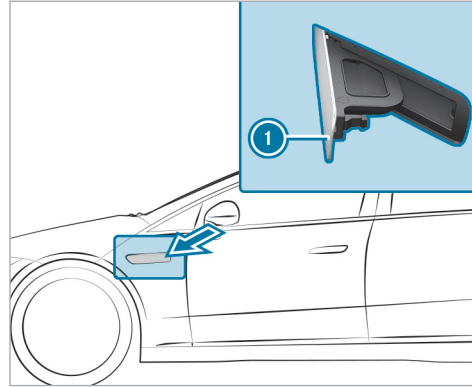

- ▶ Press on the rear area of washer fluid filler flap **1**. Washer fluid filler flap **1** will open.
 - ▶ Add washer fluid.
 - ▶ Close washer fluid filler flap **1**.
- i** Further information about windshield washer fluid (→ page 444)

Cleaning and care

Information on washing the vehicle in a car wash

⚠ WARNING Risk of accident due to reduced braking effect after washing the vehicle

The braking effect is reduced after washing the vehicle.

- ▶ After the vehicle has been washed, brake carefully while paying attention to the traffic conditions until the braking effect has been fully restored.

! **NOTE** Damage from automatic braking

If one of the following functions is activated, the vehicle will brake automatically in certain situations:

- Active Brake Assist
- Active Distance Assist DISTRONIC
- HOLD function
- Active Parking Assist

To avoid damage to the vehicle, deactivate these systems in the following or similar situations:

- ▶ During towing.
- ▶ In a car wash.

! **NOTE** Damage due to unsuitable car wash

- ▶ Before driving into a car wash make sure that the car wash is suitable for the vehicle dimensions.
- ▶ Ensure there is sufficient ground clearance between the underbody and the guide rails of the car wash.
- ▶ Ensure that the clearance width of the car wash, in particular the width of the guide rails, is sufficient.

To avoid damage to your vehicle when using a car wash, ensure the following beforehand:

- Active Distance Assist DISTRONIC is deactivated.
- The HOLD function is switched off.

- The 360° camera or the reversing camera is switched off.
 - The vehicle is locked and the door handles are retracted.
 - The side windows and sliding sunroof are completely closed.
 - The outside mirrors are folded in.
 - The blower for the ventilation and heating is switched off.
 - The windshield wiper switch is in position **0**.
 - The key is at a minimum distance of 20 ft (6 m) away from the vehicle. Otherwise, the tailgate or a door could open unintentionally. This also applies to the Digital Vehicle Key.
 - For car washes with a conveyor system:
 - Neutral **N** is engaged.
 - The vehicle is locked from the inside.
- i** If, after the car wash, you remove the wax from the windshield and wiper rubbers, this will prevent smearing and reduce wiper noise.

Automatic car wash mode

In car wash mode, the vehicle is prepared for driving into an automatic car wash. Car wash mode can be activated at a speed of up to 12 mph (20 km/h) (→ page 383).

When car wash mode is activated, the **Automatic Car Wash Mode Active** message will appear on the driver's display. The following adjustments will be made:

- The outside mirrors will be folded in.
- To prevent the windshield washer system from starting up automatically, the rain sensor will be deactivated.
- The rear window wiper will be deactivated.
- The comfort doors will be deactivated.
- Parking Assist PARKTRONIC will be deactivated.
- **Vehicles with 360° camera:** The front image will be activated after approximately eight seconds.
- **Vehicles with HANDS-FREE ACCESS:** kick detection will be deactivated.

If one of the settings cannot be selected, this will be shown by the  symbol next to the respective setting.

Pressing **Switch Off** will cancel car wash mode. Above a speed of 12 mph (20 km/h), car wash mode will be deactivated automatically.

You can also switch off car wash mode via the MBUX multimedia system (→ page 383).

The following settings will be reset when car wash mode is deactivated:

- The outside mirrors will be folded out.
- The rain sensor will be activated.
- The rear window wiper will be activated.
- The comfort doors will be activated.
- Parking Assist PARKTRONIC will be reset to the previously selected setting.
- **Vehicles with 360° camera:** The front image will be deactivated at speeds above 11 mph (18 km/h).
- **Vehicles with HANDS-FREE ACCESS:** Kick detection will be activated.

Activating or deactivating car wash mode

Requirements

- The vehicle is stationary.
- The vehicle is switched on.

Multimedia system:

 **▶▶ Settings ▶▶ Vehicle ▶▶ Driving**

Activating automatic car wash mode

- ▶ Select **Automatic Car Wash Mode**.
- ▶ Select **Activate**.

If one of the settings cannot be selected, this is shown with  next to the respective setting.

-  For an overview of the settings made when activating automatic car wash mode (→ page 381).

Deactivating automatic car wash mode

- ▶ Select **Switch Off**.
- ▶ The automatic car wash settings are reset.
-  The automatic car wash mode is automatically deactivated as soon as a speed of 12 mph (20 km/h) is exceeded.

Information on using a power washer

 **WARNING** Risk of an accident when using power washers with round-spray nozzles

The water jet can cause externally invisible damage.

Components damaged in this way may unexpectedly fail.

- ▶ Do not use a power washer with round-spray nozzles.
- ▶ Have damaged tires or chassis parts replaced immediately.

To avoid damage to your vehicle when using a power washer, ensure the following:

- The key is at a minimum distance of 10 ft (3 m) away from the vehicle. Otherwise, the tailgate or a door could open unintentionally. This also applies to the Digital Vehicle Key.
- Keep a minimum distance of 11.8 in (30 cm) from the vehicle.
- **Vehicles with decorative foil:** parts of your vehicle are covered with decorative foil. Main-

tain a minimum distance of at least 27.6 in (70 cm) between the foiled parts of the vehicle and the nozzle of power washer. Move the power washer nozzle around when cleaning your vehicle. The water temperature of the power washer must not exceed 140 °F (60 °C).

- Observe the information on the correct distance in the operating instructions of the equipment manufacturer.
- Do not point the nozzle of the power washer directly at any sensitive parts, e.g. tires, gaps, electrical components, batteries, illuminants or louvers.

Washing the vehicle by hand

Observe the relevant legal requirements (e.g. in some countries, washing by hand is permitted only in specially designated wash bays).

- ▶ Use a mild cleaning agent (e.g. car shampoo).
- ▶ Wash the vehicle with lukewarm water using a soft car sponge. When doing so, do not expose the vehicle to direct sunlight.

▶ Carefully hose the vehicle off with water and dry using a chamois.

ⓘ Observe the notes on the care of car parts (→ page 385).

Notes on paintwork/matt finish paintwork care

To avoid damaging the paintwork and interfering with the driving assistance systems, please observe the following notes:

Paint

- Insect remains: soak with insect remover and rinse off the treated areas afterwards.
- Bird droppings: soak with water and rinse off afterwards.
- Tree resin, oils, fuels and greases: remove by rubbing gently with a cloth soaked in petroleum ether or lighter fluid.
- Coolant and brake fluid: remove with a damp cloth and clean water.
- Tar stains: use tar remover.
- Wax: use silicone remover.

- Do not attach stickers, films or similar materials. Have film attached to the bumper only at a qualified specialist workshop.
- Remove dirt immediately, where possible.

Matt finish

- Use only care products approved for Mercedes-Benz.
- Do not attach stickers, films or similar materials. Have film attached to the bumper only at a qualified specialist workshop.
- Do not polish the vehicle and alloy wheels.
- Use only car washes that correspond to the latest engineering standards.
- Do not use any car wash program with a final hot wax treatment.
- Do not use paint cleaners, buffing or polishing products or gloss preservers, e.g. wax.

In the event of paintwork damage:

- Always have paintwork repairs carried out at a qualified specialist workshop.
- Make sure the radar sensors function (→ page 225).

Notes on cleaning decorative films

Observe the "Notes on paintwork/matte finish paintwork care" (→ page 384). They also apply to matte decorative films.

Observe the notes on cleaning decorative films to avoid damage.

Cleaning

- For cleaning, use plenty of water and a mild cleaning agent without additives or abrasive substances (e.g. a car shampoo approved for Mercedes-Benz).
- Remove dirt as soon as possible. Avoid rubbing too hard in order not to damage the decorative film irreparably.
- If there is dirt on the finish or if the decorative film is dull: use the paint cleaner recommended and approved for Mercedes-Benz.
- Insect remains: soak with insect remover and rinse off the treated areas afterwards.
- Bird droppings: soak with water and rinse off afterwards.

- To prevent water stains, dry a film-wrapped vehicle with a soft, absorbent cloth after every car wash.

Avoiding damage to the decorative film

- The service life and color of decorative films are impaired by:
 - Sunlight
 - Temperature (e.g. hot air blower)
 - Weather conditions
 - Stone chippings and dirt
 - Chemical cleaning agents
 - Oily products
- Do not use polish on matte decorative film. Polishing will have the effect of shining the film-wrapped surface.
- Do not treat matte or structured decorative films with wax. Permanent stains may occur.

Scratches, corrosive deposits, areas affected by corrosion and damage caused by incorrect care cannot always be completely repaired. In this case, contact a qualified specialist workshop.

You can obtain more information on care and cleaning agents from the manufacturer.

In the case of film-wrapped surfaces, visual differences may occur between the surfaces that were not protected by a decorative film after a decorative film has been removed.

- ① Have work or repairs to decorative films carried out at a qualified specialist workshop (e.g. at an authorized Mercedes-Benz Center).

Notes on care of car parts

⚠ WARNING Risk of entrapment if the windshield wipers are switched on while the windshield is being cleaned

If the windshield wipers are set in motion while you are cleaning the windshield or wiper blades, you can be trapped by the wiper arm.

- ▶ Always switch off the windshield wipers and the drive system before cleaning the windshield or wiper blades.

To avoid damage to the vehicle, observe the notes on cleaning and care of the following car parts:

Wheels and rims

- Use water and acid-free alloy wheel cleaners.
- Do not use acidic alloy wheel cleaners to remove brake dust. This could damage wheel bolts and brake components.
- To avoid corrosion of the brake discs and pads, drive the vehicle for a few minutes after cleaning before parking it. The brake discs and pads will warm up and dry out.

Windows

! **NOTE** Damage to electronic components due to excess fluids

When cleaning the windows from the inside, fluids such as cleaning agents or water may run down and get behind trim parts of the vehicle interior and cause damage to electronic components.

- ▶ Use cleaning agents as sparingly as possible.
- ▶ Immediately absorb any excess fluids.

- Clean the windows inside and outside with a damp cloth and with a cleaning agent recommended for Mercedes-Benz.
- Do not use dry cloths or abrasive or solvent-based cleaning agents to clean the insides of windows.
- ① After changing the wiper blades or treating the vehicle with wax, clean the windshield thoroughly with cleaning agents recommended for Mercedes-Benz. Failure to observe the application instructions may result in damage, smear marks or glare spots.
- ① Remove external fogging or dirt on the windshield in front of the multifunction camera. Otherwise, driving systems and driving safety systems may be impaired or unavailable (→ page 225).

Wiper blades

- Move the wiper arms into the replacement position (→ page 158).
- With the wiper arms folded out, clean the wiper blades with a damp cloth.

- ① Make sure that the wiper blades are coated. The coating may leave residue on a cloth. Do not rub the wiper blades excessively or clean them too often.

Exterior lighting

- Clean the lenses with a wet sponge and mild cleaning agent (e.g. car shampoo).
- Use only cleaning agents or cleaning cloths that are suitable for plastic lenses.

Vehicle socket (high-voltage battery)

- Use clean water and a soft cloth to clean the vehicle socket.
- Do not use power washers or cleaning agents such as soap.

Sensors

- Clean the sensors in the front and rear bumpers with a soft cloth and car shampoo (→ page 225).
- When using a power washer, maintain a minimum distance of 11.8 in (30 cm).

Running boards

- Use water and acid-free cleaning agents.

- Do not clean the aluminum trim inserts of the running board with alkaline or acidic cleaning agents such as wheel cleaners. Do not use acidic alloy wheel cleaners to remove brake dust. The aluminum trim inserts could otherwise be damaged.

Reversing camera and 360° Camera

- Open the camera cover with the multimedia system (→ page 280).
- Use clean water and a soft cloth to clean the camera lens.
- Do not use a power washer.

Trailer hitch

- Observe the notes on care in the trailer hitch manufacturer's operating instructions.
- Do not clean the ball neck with a power washer or solvent.
- Remove traces of rust on the ball (e.g. using a wire brush).
- Remove dirt with a lint-free cloth.
- After cleaning, lightly oil or grease the ball head.

- ⓘ Before using trailers with anti-torsional coupling, observe the manufacturer's operating instructions.

Notes on care of the interior

⚠ WARNING Risk of injury from plastic parts breaking off after the use of solvent-based care products

Care and cleaning products containing solvents can cause surfaces in the cockpit to become porous. When the airbags are deployed, plastic parts may break away.

- ▶ Do not use any care or cleaning products containing solvents to clean the cockpit.

⚠ WARNING Risk of injury or fatal injuries from bleached seat belts

Bleaching or dyeing seat belts can severely weaken them.

This can, for example, cause seat belts to tear or fail in an accident.

- ▶ Never bleach or dye seat belts.

To avoid damage to the vehicle, observe the following notes on cleaning and care:

Seat belts

- Clean with lukewarm soapy water.
- Do not use chemical cleaning agents.
- Do not dry by heating them to over 176°F (80°C) or exposing them to direct sunlight.

Display

- Switch off the display and let it cool down.
- Clean the surface carefully with a microfiber cloth and a suitable display care product (TFT-LCD).
- Do not use any other agents.

Head-up display

- Clean with a soft, non-static, lint-free cloth.
- Do not use cleaning agents.

Plastic trim

- Clean with a damp microfiber cloth.
- For heavy soiling: use a cleaning agent recommended for Mercedes-Benz.

- Do not attach stickers, films or similar materials.
- Do not allow cosmetics, insect repellent or sun cream to come into contact with the plastic trim.

Real wood and trim elements

- Clean with a microfiber cloth.
- Black piano-lacquer look: clean with a damp cloth and soapy water.
- For heavy soiling: use a cleaning agent recommended for Mercedes-Benz.
- Do not use solvent-based cleaning agents, polishes or waxes.

Headliner

- Clean with a brush or dry shampoo.

Carpet

- Use a carpet and textile cleaning agent recommended for Mercedes-Benz.

Steering wheel made of genuine leather or DINAMICA

! NOTE Damage caused by wrong cleaners

▶ Do not use solvent-based cleaning agents such as tar remover or wheel cleaner; neither should you use polishes or waxes. Otherwise you may damage the finish.

- Clean with a damp cloth and 1% soapy water solution and then wipe with a dry cloth.
- For heavy soiling: use a cleaning agent recommended for Mercedes-Benz.
- Leather care: use a leather care agent that has been recommended for Mercedes-Benz.
- Do not allow the leather to become too damp.
- Do not use a microfiber cloth.

i Leather is a natural product. It exhibits natural surface properties such as differences in structure, marks caused by growth and injury or subtle color differences. These surface properties are characteristics of leather and

not material malfunctions. Leather is also subject to a natural aging process during which the surface properties change.

Genuine leather seat covers

- Vacuum up dirt such as crumbs or dust and then clean the seat covers with a damp cotton cloth and wipe down with a dry cloth. Regularly clean the seat covers.
- For heavy soiling: use a leather care agent recommended for Mercedes-Benz aftercare.
- Leather care: use a leather care agent that has been recommended for Mercedes-Benz.
- Do not use a microfiber cloth.
- Do not allow the leather to become too damp.
- Do not use oil-based cleaning and care products.

- i** Leather is a natural product. It exhibits natural surface properties such as differences in structure, marks caused by growth and injury or subtle color differences. These surface properties are characteristics of leather and not material malfunctions. Leather is also subject to a natural aging process during which the surface properties change. Waves or wrinkling in the seat cover may occur due to the stress on the seat; this is caused by the natural leather material. Regular cleaning and care of the leather reduces soiling, wear marks and aging damage and thus significantly extends its life span. Clothing that can leave stains (e.g. jeans) may discolor the leather.

DINAMICA seat covers

- Vacuum up dirt such as crumbs or dust and then use a damp cloth to clean.
- Do not use a microfiber cloth.

Imitation leather seat covers

- Vacuum up dirt such as crumbs or dust and then use a damp cotton cloth and a 1% soap

solution to clean the entire seat cover. Do not spot clean.

- Use cleaning and care products recommended for Mercedes-Benz.
- Do not use a microfiber cloth.
- Do not use oil-based cleaning and care products.

Emergency

Removing the safety vest

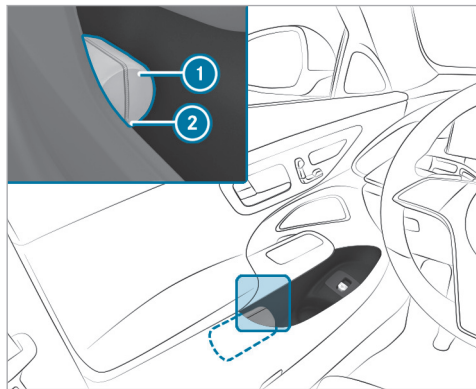

There is a safety vest compartment in the door stowage compartments of all doors for storing a safety vest.

- ▶ To remove: pull out safety vest bag ① by loop ②.

- ▶ Open safety vest bag ① and pull out the safety vest.
- ▶ To stow: fold the safety vest, roll it up and stow it in safety vest bag ①.
- ▶ Slide safety vest bag ① along the lower edge of the armrest into the safety vest compartment. At the same time, ensure that loop ② hangs out well within reach.

- ⓘ Remove a new safety vest from its packaging material before sliding it into the safety vest compartment. The packaging material may otherwise cause it to slip out or make removing it difficult.
- Observe the legal requirements in each country.

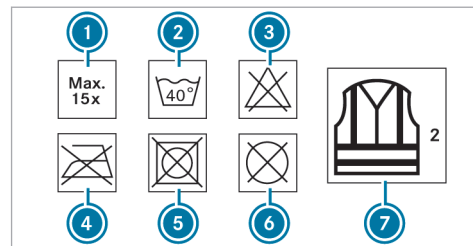

- ① Maximum number of washes
- ② Maximum wash temperature
- ③ Do not bleach
- ④ Do not iron
- ⑤ Do not tumble dry
- ⑥ Do not dry clean
- ⑦ Class 2 safety vest

The requirements defined by the legal standard are only fulfilled if the safety vest is the correct size and is fully closed.

Replace the safety vest in the following cases:

- The reflective strips are damaged or dirty

- The maximum permissible number of washes is exceeded
- The fluorescence has faded, e.g. due to continuous exposure to sunlight.

Dispose of the safety vest in an environmentally responsible manner:

- To do so, contact your local waste disposal company.

Warning triangle

Removing the warning triangle

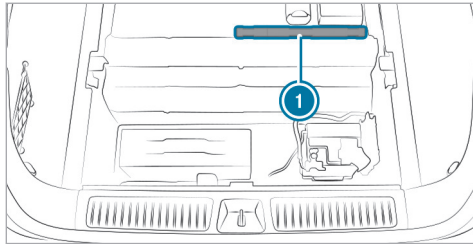

Warning triangle (1) is located under the cargo floor.

- ▶ Remove warning triangle (1).

Setting up the warning triangle

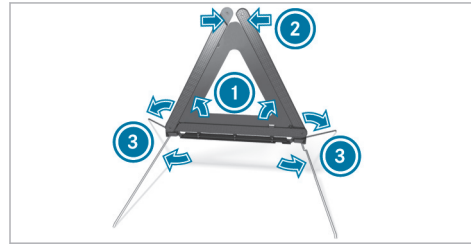

- ▶ Fold side reflectors (1) upwards to form a triangle and attach at the top using upper press-stud (2).
- ▶ Fold legs (3) down and out to the side.

First-aid kit (soft sided)

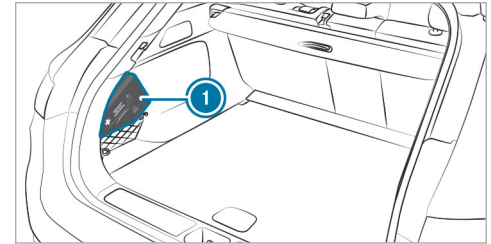

First-aid kit (soft-sided) (1) is located in the net in the cargo compartment on the left when the vehicle is delivered.

Removing the fire extinguisher

⚠ WARNING Risk of accident due to an incorrectly secured fire extinguisher in the driver's footwell

A fire extinguisher may impede pedal travel or block a depressed pedal.

This jeopardizes the operating and road safety of the vehicle.

The fire extinguisher can be flung around and injure the driver or other vehicle occupants.

- ▶ Always store and secure the fire extinguisher in the bracket.
- ▶ Do not remove the fire extinguisher while driving.

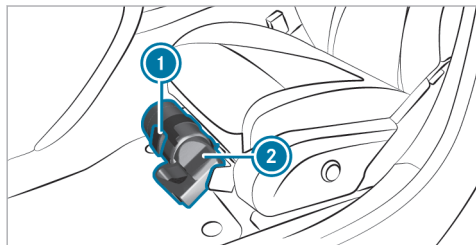

- ▶ **Left-hand drive vehicle:** Pull tab ❶ upwards.
- ▶ Remove fire extinguisher ❷.

Flat tire

Notes on flat tires

⚠ WARNING Risk of accident due to a flat tire

A flat tire severely affects the driving characteristics as well as the steering and braking of the vehicle.

Tires without run-flat characteristics:

- ▶ Do not drive with a flat tire.
- ▶ Change the flat tire immediately with an emergency spare wheel or spare wheel. Alternatively, consult a qualified specialist workshop.

Tires with run-flat characteristics:

- ▶ Observe the information and warning notes on MOExtended tires (run-flat tires).

In the event of a flat tire, the following options are available depending on your vehicle's equipment:

- **Vehicles with MOExtended tires:** it is possible to continue the journey for a short period of time. Make sure you observe the notes on MOExtended tires (run-flat tires) (→ page 393).
 - **Vehicles with a TIREFIT kit:** you can seal the tire so that it is possible to continue the journey for a short period of time. To do this, use the TIREFIT kit (→ page 394).
 - **Vehicles with Mercedes me connect:** you can make a call for breakdown assistance via the overhead control panel in the case of a breakdown (→ page 359).
 - **All vehicles:** change the wheel (→ page 431).
- ❶ The emergency spare wheel is only available in certain countries.

Notes on MOExtended tires (run-flat tires)

▲ WARNING Risk of accident when driving in limp-home mode

When driving in emergency mode the handling characteristics are impaired.

- ▶ Do not exceed the specified maximum speed of the MOExtended tires.
- ▶ Avoid any abrupt steering and driving maneuvers as well as driving over obstacles (curbs, pot holes, off-road). This applies, in particular, to a loaded vehicle.
- ▶ Stop driving in the emergency mode if you notice:
 - Banging noise
 - Vehicle vibration
 - Smoke which smells like rubber
 - Continuous ESP® intervention
 - Cracks in the tire side walls
- ▶ After driving in emergency mode, have the rims checked by a qualified specialist

workshop with regard to their further use.

- ▶ The defective tire must be replaced in every case.

With MOExtended tires (run-flat tires), you can continue to drive your vehicle even if there is a total loss of pressure in one or more tires. However, the tire affected must not show any clearly visible damage.

You can recognize MOExtended tires by the MOExtended marking which appears on the side wall of the tire.

Vehicles with tire pressure monitoring system: MOExtended tires may only be used in conjunction with an activated tire pressure monitoring system.

If a pressure loss warning message appears in the driver's display, proceed as follows:

- Check the tire for damage.
- If driving on, observe the following notes.

Driving distance possible in emergency mode after the pressure loss warning:

Load condition	Driving distance possible in emergency mode
Partially laden	50 miles (80 km)
Fully laden	19 miles (30 km)

The driving distance possible in emergency mode may vary depending on the driving style. Observe the maximum permissible speed of 50 mph (80 km/h).

If a tire has gone flat and cannot be replaced with an MOExtended tire, you can use a standard tire as a temporary measure.

TIREFIT kit storage location

The TIREFIT kit is located under the cargo floor.

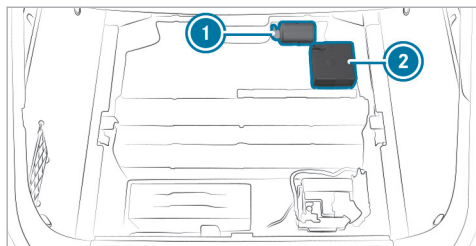

- ① Tire inflation compressor
- ② Tire sealant bottle

Depending on the model, the TIREFIT kit may also be located in other places under the cargo floor.

Using the TIREFIT kit

Requirements

- Tire sealant bottle and tire inflator compressor are ready for use (→ page 393).
- TIREFIT sticker is present.
- Gloves are present.

You can use TIREFIT tire sealant to seal perforation damage of up to 0.16 in (4 mm), particularly those in the tire tread. You can use TIREFIT in outside temperatures down to -4°F (-20°C).

⚠ WARNING Risk of accident when using tire sealant

The tire sealant may be unable to seal the tire properly, especially in the following cases:

- There are large cuts or punctures in the tire (larger than damage previously mentioned)
 - The wheel rims have been damaged
 - After journeys with very low tire pressure or with flat tires
- ▶ Do not continue driving.
 - ▶ Consult a qualified specialist workshop.

⚠ WARNING Risk of injury and poisoning from tire sealant

The tire sealant is harmful and causes irritation. Do not allow it to come into contact with

the skin, eyes or clothing, and do not swallow it. Do not inhale tire sealant fumes. Keep the tire sealant away from children.

If you come into contact with the tire sealant, observe the following:

- ▶ Rinse off the tire sealant from your skin immediately using water.
- ▶ If tire sealant gets into your eyes, thoroughly rinse out the eyes using clean water.
- ▶ If tire sealant has been swallowed, immediately rinse out the mouth thoroughly and drink plenty of water. Do not induce vomiting and seek medical attention immediately.
- ▶ Change out of any clothes contaminated with tire sealant immediately.
- ▶ If allergic reactions occur, seek medical attention immediately.

! **NOTE** Overheating due to the tire inflation compressor running too long

- ▶ Do not run the tire inflation compressor for longer than ten minutes without interruption.

Comply with the manufacturer's safety notes on the sticker on the tire inflation compressor. Have the tire sealant bottle replaced in a qualified specialist workshop every five years.

- ▶ Do not remove any foreign objects that have entered the tire.

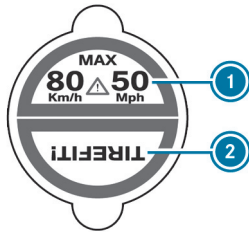

- ▶ Affix part ① of the TIREFIT sticker to the instrument cluster within the driver's field of vision.
- ▶ Affix part ② of the TIREFIT sticker near the valve on the wheel with the defective tire.

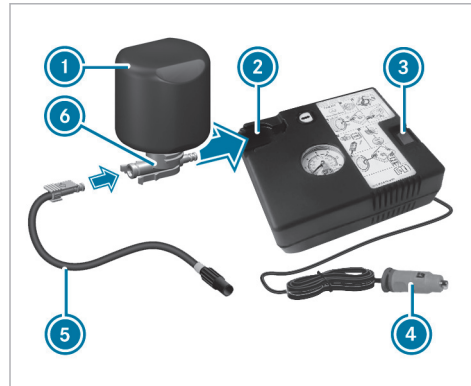

- ▶ Pull plug ④ with the cable and hose ⑤ out of the tire inflation compressor housing.

- ▶ Push the plug of hose ⑤ into flange ⑥ of tire sealant bottle ① until the plug engages.
- ▶ Place tire sealant bottle ① head downwards into recess ② of the tire inflation compressor.

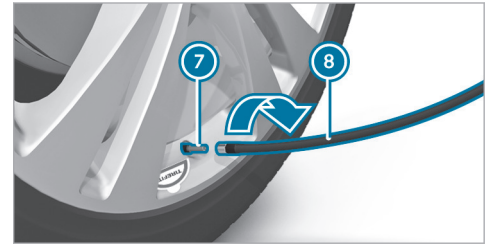

- ▶ Remove the valve cap from valve ⑦ on the faulty tire.
- ▶ Screw filling hose ⑧ onto valve ⑦.
- ▶ Insert plug ④ into a 12-V-socket in your vehicle.
- ▶ Switch on the vehicle.

- ▶ Switch on the tire inflation compressor using On/Off switch .
- The tire is inflated. First, tire sealant is pumped into the tire. The pressure may briefly rise to approximately 500 kPa (5.0 bar/73 psi).

Do not switch off the tire inflation compressor during this phase!

- ▶ Let the tire inflation compressor run for a maximum of ten minutes.
The tire should then have attained a tire pressure of at least 200 kPa (2.0 bar/29 psi).

If tire sealant leaks out, make sure you clean the affected area as quickly as possible. It is preferable to use clean water.

If you get tire sealant on your clothing, have it cleaned as soon as possible with perchloroethylene.

If, after ten minutes, a tire pressure of 200 kPa (2.0 bar/29 psi) has not been attained:

- ▶ Switch off the tire inflation compressor.
- ▶ Unscrew the filling hose from the valve of the defective tire.

Please note that tire sealant may leak out when unscrewing the filling hose.

- ▶ Drive forwards or in reverse very slowly for approximately 33 ft (10 m).
- ▶ Pump up the tire again.
After a maximum of ten minutes the tire pressure must be at least 200 kPa (2.0 bar/29 psi).

⚠ WARNING Risk of accident due to the specified tire pressure not being achieved

If the specified tire pressure is not achieved after the specified time, the tire is too badly damaged. The tire sealant cannot repair the tire in this instance.

The braking characteristics as well as the driving characteristics may be greatly impaired.

- ▶ Do not continue driving.
- ▶ Consult a qualified specialist workshop.

If, after ten minutes, a tire pressure of 200 kPa (2.0 bar/29 psi) has been attained:

- ▶ Switch off the tire inflation compressor.

- ▶ Unscrew the filling hose from the valve of the defective tire.

⚠ WARNING Risk of accident from driving with sealed tires

A tire temporarily sealed with tire sealant impairs the handling characteristics and is not suitable for higher speeds.

- ▶ Adapt your driving style accordingly and drive carefully.
- ▶ Do not exceed the maximum speed limit with a tire that has been repaired using tire sealant.

- ▶ Observe the maximum permissible speed of 50 mph (80 km/h) for a tire sealed with tire sealant.

! NOTE Staining caused by leaking tire sealant

After use, excess tire sealant may leak out from the filling hose.

- ▶ Therefore, place the filling hose in the plastic bag that contained the TIREFIT kit.

 **ENVIRONMENTAL NOTE** Environmental pollution caused by environmentally irresponsible disposal

Tire sealant contains pollutants.

- ▶ Have the tire sealant bottle disposed of professionally, e.g. at an authorized Mercedes-Benz Center.

- ▶ Stow the tire sealant bottle and the tire inflation compressor.
- ▶ Pull away immediately.
- ▶ Stop driving after approximately ten minutes and check the tire pressure using the tire inflation compressor.
The tire pressure must now be at least 130 kPa (1.3 bar/19 psi).

⚠ WARNING Risk of accident due to the specified tire pressure not being attained

If the specified tire pressure is not reached, the tire is too badly damaged. The tire sealant cannot repair the tire in this instance.

The braking and driving characteristics may be greatly impaired.

- ▶ Do not continue driving.
- ▶ Consult a qualified specialist workshop.

In cases such as the one mentioned above, contact an authorized Mercedes-Benz Center. Or call 1-800-FOR-MERCEdes (in the USA) or 1-800-387-0100 (in Canada).

- ▶ **To increase the tire pressure:** switch on the tire inflation compressor.

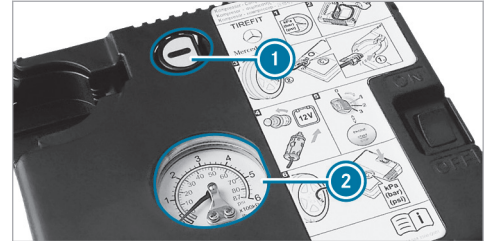

- ▶ **To reduce the tire pressure:** press pressure release button ① next to manometer ②.
- ▶ When the tire pressure is correct, unscrew the filling hose from the valve of the sealed tire.
- ▶ Screw the valve cap onto the valve of the sealed tire.
- ▶ Pull the tire sealant bottle out of the tire inflation compressor.
The filling hose stays on the tire sealant bottle.
- ▶ Drive to the nearest qualified specialist workshop and have the tire, tire sealant bottle and filling hose replaced there.

Battery (vehicle)**Notes on the 12 V battery**

⚠ WARNING Risk of explosion due to electrostatic charge

Electrostatic charge can ignite the highly explosive gas mixture in the battery.

- ▶ To discharge any electrostatic charge that may have built up, touch the metal vehicle body before handling the battery.

The highly flammable gas mixture is created while the battery is charging and during starting assistance.

For safety reasons, Mercedes-Benz recommends that you only use batteries which have been tested and approved for your vehicle by Mercedes-Benz.

⚠ WARNING Danger of chemical burns from the battery acid

Battery acid is caustic.

- ▶ Avoid contact with the skin, eyes or clothing.
- ▶ Do not lean over the battery.
- ▶ Do not inhale battery gases.
- ▶ Keep children away from the battery.
- ▶ Immediately rinse battery acid off thoroughly with plenty of clean water and seek medical attention immediately.



ENVIRONMENTAL NOTE Environmental damage due to improper disposal of batteries



Batteries contain pollutants. It is illegal to dispose of them with the household rubbish.



Dispose of batteries in an environmentally responsible manner. Take discharged batteries to a qualified

specialist workshop or to a collection point for used batteries.

If you have to disconnect the 12 V battery, contact a qualified specialist workshop.

Comply with safety notes and take protective measures when handling batteries.



Risk of explosion.



Fire, open flames and smoking are prohibited when handling the battery. Avoid creating sparks.



Electrolyte or battery acid is corrosive. Avoid contact with the skin, eyes or clothing. Wear suitable protective clothing, in particular gloves, an apron and a face mask. Immediately rinse electrolyte or acid splashes off with clean water. Consult a doctor immediately.



Wear safety glasses.



Keep children away.



Observe this Operator's Manual.

If you do not want to use the vehicle for a long period of time, consult a qualified specialist workshop.

Notes on the high-voltage battery

⚠ DANGER Risk of fire and explosion from excessive internal pressure of the high-voltage battery

In the event of a vehicle fire, flammable gas can escape and ignite.

- ▶ If there is an unusual smell, smoke or burn marks, stop the charging process immediately.
- ▶ Leave the danger zone immediately. Secure the danger area at a sufficient distance.



Call the fire service.

Observe the notes on charging the high-voltage battery (→ page 200).



Risk of explosion.



Fire, open flames and smoking are prohibited when you are handling the battery. Avoid creating sparks.



Electrolyte or battery acid is corrosive. Avoid contact with the skin, eyes or clothing. Wear suitable protective clothing, especially gloves, an apron and a safety mask. Immediately rinse electrolyte or acid splashes off with clean water. Consult a doctor immediately.



Wear safety glasses.



Keep children away.



Observe this Operator's Manual.

Starting assistance and charging the 12 V battery

- ▶ Only have starting assistance provided by a qualified specialist workshop, e.g. an authorized Mercedes-Benz Center.
- ▶ Only have the battery charged at a qualified specialist workshop, e.g. an authorized Mercedes-Benz Center.

Replacing the 12 V battery

- ▶ Only have the battery replaced at a qualified specialist workshop, e.g. at an authorized Mercedes-Benz Center.

Tow starting or towing away

Overview of the permitted towing methods

! NOTE Damage from automatic braking

If one of the following functions is activated, the vehicle will brake automatically in certain situations:

- Active Brake Assist
- Active Distance Assist DISTRONIC
- HOLD function
- Active Parking Assist

To avoid damage to the vehicle, deactivate these systems in the following or similar situations:

- ▶ During towing.
- ▶ In a car wash.

Mercedes-Benz recommends transporting your vehicle in the case of a breakdown, rather than towing it away.

For towing with both axles on the ground, use a tow rope or tow bar. Do not use tow bar systems.

If you notice that the vehicle has lost coolant, do not have it towed away. Have the vehicle transported instead.

! NOTE Damage to the vehicle due to towing away incorrectly

- ▶ Observe the instructions and notes on towing away.

Vehicles with rear wheel drive

Permitted towing methods

Both axles on the ground	Yes, for a maximum of 30 miles (50 km) at 30 mph (50 km/h), only forwards with the driver in the cockpit
Front axle raised	No
Rear axle raised	Yes, for a maximum of 30 miles (50 km) at 30 mph (50 km/h)

4MATIC vehicles

Permitted towing methods

Both axles on the ground	Yes, for a maximum of 30 miles (50 km) at 30 mph (50 km/h), only forwards with the driver in the cockpit
Front axle raised	No
Rear axle raised	No

Towing the vehicle with both axles on the ground



- ▶ Observe the notes on the permitted towing methods (→ page 400).
- ▶ Make sure that the 12-V-battery is connected and charged

Observe the following points when the 12-V-battery is disconnected or discharged

- The drive system cannot be started
- The electric parking brake cannot be released or applied

- The selector lever cannot be put into position **N** or **P**.

Only one transport is permitted when at least one of the following conditions occur:

- If the selector lever cannot be put into position **N**.
- If the 12 V battery is disconnected or discharged.
- If the display on the instrument cluster is not working
- If the  **Towing Not Permitted See Operator's Manual** message is displayed
- If the  **Check Coolant Level See Operator's Manual** message is displayed
- If the  **Stop Switch Off Vehicle** message is displayed

▶ In such cases, transport the vehicle (→ page 402).

! **NOTE** Damage due to towing away at excessively high speeds or over long distances

The drivetrain could be damaged when towing at excessively high speeds or over long distances.

- ▶ A towing speed of 30 mph (50 km/h) must not be exceeded.
- ▶ A towing distance of 30 miles (50 km) must not be exceeded.

! **WARNING** Risk of accident when towing a vehicle which is too heavy

If the vehicle to be tow-started or towed away is heavier than the permissible gross mass of your vehicle, the following situations can occur:

- The towing eye may become detached.
- The vehicle/trailer combination may swerve or rollover.
- ▶ Before tow-starting or towing away, check if the vehicle to be tow-started or

towed away exceeds the permissible gross mass.

If a vehicle has to be tow-started or towed away, its permissible gross mass must not exceed the permissible gross mass of the towing vehicle.

▶ Information on the permissible gross mass of the vehicle can be found on the vehicle identification plate (→ page 441).

Towing away the vehicle

- ▶ Install the towing eye (→ page 405).
- ▶ Fasten the towing device.

! **NOTE** Damage due to incorrect connection of the tow bar

▶ Only connect the tow rope or tow bar to the towing eyes.

- ▶ Deactivate the automatic locking mechanism (→ page 87).
- ▶ Do not activate the HOLD function.
- ▶ Deactivate the tow-away alarm (→ page 109).

- ▶ Deactivate Active Brake Assist (→ page 259).
- ▶ Put the selector lever into position **N**.
- ▶ Release the electric parking brake.
- ▶ Remain in the cockpit during towing and observe the display messages.
- ▶ Do not switch off the vehicle while it is being towed.
- ▶ Do not open the driver's door or front passenger door, because otherwise the selector lever automatically switches to position **P**.

⚠ WARNING Risk of accident due to limited safety-related functions during the towing process

Safety-related functions are limited or no longer available in the following situations:

- The vehicle is switched off.
- The brake system or power steering system is malfunctioning.
- The energy supply or the on-board electrical system is malfunctioning.

▶ In such cases, do not tow the vehicle.

- ▶ Transport the vehicle (→ page 402).

! **NOTE** Damage to the drive system due to incorrect towing

The vehicle may not be towed in the following situations:

- The vehicle is switched off.
- The brake system or power steering system is malfunctioning.
- The energy supply or the on-board electrical system is malfunctioning.

▶ In such cases, do not tow the vehicle.

! **NOTE** Damage due to excessive tractive power

If you pull away sharply, the tractive power may be too high and the vehicles could be damaged.

▶ Pull away slowly and smoothly.

Loading the vehicle for transport

Requirements

- The vehicle is stationary.
- The vehicle is switched off.
- The driver's display is in the initial state with no menus open (→ page 310). Transport is also possible with a warning message visible.
- The 12-V-battery is charged.

▶ If necessary, set the system language (→ page 336).

▶ Observe the notes on towing away (→ page 400).

▶ Connect the towing device to the towing eye in order to load the vehicle.

i **Vehicles with a trailer hitch:** you can also attach the tow bar to the trailer hitch.

▶ Switch on the power supply (→ page 181).

▶ Put the selector lever into position **N**.

- ⓘ The selector lever may be locked in position **[P]** in the event of electrical malfunctions. To shift to **[N]**, provide the on-board electrical system with power (→ page 399).

Vehicles with AIRMATIC

- !** **NOTE** Possible damage to the vehicle when loading or unloading

When loading or unloading, the vehicle must be raised to transport level.

If the transport settings are not shown or the **Vehicle Not Ready for Loading** message is displayed, the vehicle may not be loaded or unloaded.

- ▶ If required, raise the vehicle to transport level again.
- ▶ A vehicle that cannot be raised to transport level may not be loaded or unloaded using a ramp. Consult a qualified specialist workshop.



- !** **WARNING** Risk of accident due to activated transport level

If the vehicle is raised to transport level, driving and driving safety systems have only limited availability and the view from the vehicle is restricted.

Driving safety is severely restricted and there is a risk of an accident!

- ▶ Do not use transport level in normal road operation.
- ▶ Only activate and use transport level to load the vehicle and when not on public roads.

- ▶ Ensure that no persons or obstacles are located in the area surrounding the vehicle.

Raising the vehicle to transport level

- ▶ Press the **[↶]** button for at least five seconds.
- ▶ Immediately press and hold the **[OK]** button for at least one second. The **For Transport Level Switch On Vehicle** message is displayed.
- ▶ Select **vehicle transport**.
- ⓘ The noise certification mode is intended exclusively for the technical test organization. It restricts the drive power of the vehicle and must not be used in customer operation.
- ▶ Switch on the vehicle (→ page 183). The transport settings are displayed.
- ▶ Swipe downward to select **Transport Level** and press **[OK]**. The vehicle is raised and the **Vehicle raising... Do not drive onto ramp yet** message is displayed for 5 seconds. The raising process can

last up to 60 seconds and can be canceled with the  button.

- ▶ When raising, do not switch off the vehicle.

While the vehicle is being raised, you can maneuver at a maximum speed of 25 mph (40 km/h).



- ▶ Before loading the vehicle, wait until the transport level has been reached and the **Transport Level** status is shown.
- ⓘ If the vehicle is raised to transport level, the transport settings will continue to be shown even after a restart. Operation of the driver's display is restricted.

When the vehicle is at transport level, it is lowered again in the following situations:

- When driving faster than 25 mph (40 km/h).
- The 12-V-battery is discharged.

The vehicle is adjusted to the height of the last active level.

Transporting the vehicle

⚠ WARNING Risk of accident when transporting vehicles

When you transport vehicles, the vehicle/trailer combination may begin to sway and start to skid.

- ▶ Secure the vehicle at all four wheels with suitable retaining straps.

! NOTE Damage to the vehicle due to it being secured incorrectly

- ▶ After loading, the vehicle must be secured at all four wheels. Otherwise, the vehicle could be damaged.

- ▶ Load the vehicle onto the transporter.
- ▶ Put the selector lever into position **P**.
- ▶ Use the electric parking brake to secure the vehicle against rolling away.
- ▶ Switch off the vehicle and the power supply.
- ▶ Only secure the vehicle by the wheels.

Vehicles with adaptive damping adjustment

⚠ WARNING Risk of an accident when transporting vehicles with adaptive damping adjustment

When transporting vehicles with adaptive damping adjustment, the vehicle/trailer combination may begin to rock and start to skid.

- ▶ Load the vehicle correctly onto the transporter.
- ▶ Secure the vehicle on all four wheels with suitable tensioning straps.

! **NOTE** Damage to the vehicle from securing it incorrectly

- ▶ After loading, the vehicle must be secured on all four wheels. Otherwise, the vehicle could be damaged.
- ▶ A minimum distance of 8 in (20 cm) upwards and 4 in (10 cm) downwards must be kept to the transport platform.

- ▶ Secure the vehicle on all four wheels after loading.

Unloading the vehicle Vehicles with AIRMATIC

- ▶ Make sure that the vehicle is raised to transport level before unloading (→ page 271).

Lowering the vehicle after unloading

- ▶ Switch on the power supply.
- ▶ Switch on the vehicle.

- ▶ In Transport Settings, swipe up to select the **Standard Level** and press **OK**.
The vehicle is adjusted to the height of the last active level and the **Lowering Vehicle...** message is displayed.
- ▶ After the vehicle has been lowered, press the **↩** button for at least two seconds. Transport Settings closes.

Towing eye storage location

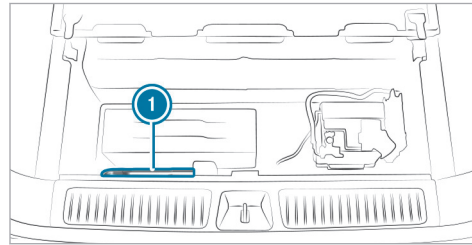

Towing eye ① is located under the cargo floor.

Installing and removing the towing eye

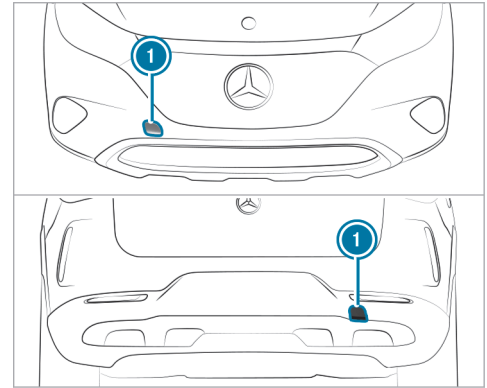

- ▶ Press cover ① inwards and remove it.
- ▶ Screw in the towing eye clockwise as far as it will go and tighten.

Vehicles with a trailer hitch: vehicles with a trailer hitch do not have a rear mount for the towing eye. Fasten the tow bar to the trailer hitch.

- ▶ After removing the towing eye, snap cover ① into the bumper.

! **NOTE** Damage to the vehicle due to incorrect use of the towing eye or trailer hitch

When a towing eye or trailer hitch is used to recover a vehicle, the vehicle may be damaged in the process.

- ▶ Only use the towing eye or trailer hitch to tow away or tow start the vehicle.
- ▶ Do not use the towing eye or trailer hitch to tow the vehicle during recovery.

Tow-starting the vehicle

- ▶ If the drive system does not start, have the vehicle transported to a qualified specialist workshop, e.g. an authorized Mercedes-Benz Center.

- ▶ You cannot start the drive system by tow-starting the vehicle. Do not make any attempts to tow-start the vehicle.

Electrical fuses

Notes on electrical fuses

! **WARNING** Risk of accident and injury due to overloaded lines

If you manipulate or bridge a faulty fuse or if you replace it with a fuse with a higher amperage, the electric line could be overloaded. This could result in a fire.

- ▶ Always replace faulty fuses with specified new fuses containing the correct amperage.

! **NOTE** Damage due to incorrect fuses

Using incorrect fuses can result in damage to electrical components or systems or their functions being considerably restricted.

- ▶ Use only fuses approved for Mercedes-Benz with the respective specified fuse rating.

Blown fuses must be replaced with fuses of the same rating, which you can recognize by the color and the label. The fuse ratings and further information to be observed can be found in the fuse assignment diagram.

Fuse assignment diagram: on the fuse box in the rear passenger compartment (→ page 407).

! **NOTE** Damage or malfunctions caused by moisture

Moisture may cause damage to the electrical system or cause it to malfunction.

- ▶ When the fuse box is open, make sure that no moisture can enter the fuse box.
- ▶ When closing the fuse box, make sure that the seal of the lid is positioned correctly on the fuse box.

If the newly inserted fuse also blows, have the cause traced and rectified at a qualified specialist workshop.

Ensure the following before replacing a fuse:

- The vehicle is secured against rolling away.
- All electrical consumers are switched off.
- The vehicle is switched off.

The electrical fuses are located in various fuse boxes:

- Fuse box on the driver's side of the cockpit (→ page 407)
- Fuse box in the front passenger footwell (→ page 407)
- Fuse box in the rear passenger compartment (→ page 407)

Opening and closing the fuse box in the cockpit

- Observe the notes on electrical fuses (→ page 406).

The fuse box is on the driver's side on the side of the cockpit under a cover.

▶ Mercedes-Benz recommends you have the fuse box opened at an authorized Mercedes-Benz Center.

Opening and closing the fuse box in the front passenger footwell

Requirements

- Observe the notes on electrical fuses (→ page 406).

Right-hand drive vehicles: the fuse box is on the left side.

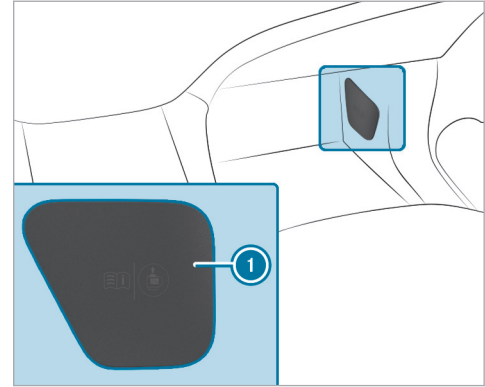

- ▶ To open the fuse box: remove cover ①.
- ▶ To close the fuse box: reinsert cover ①.

Opening and closing the fuse box in the rear passenger compartment

Requirements:

- Observe the notes on electrical fuses (→ page 406).

408 Breakdown assistance

The fuse box is located in the center of the vehicle under the seat.

- ▶ To open and close it, consult an authorized Mercedes-Benz Center.

Notes on noise or unusual handling characteristics

Make sure there are no vibrations, noises or unusual handling characteristics when the vehicle is in motion. This may indicate that the wheels or tires are damaged. Hidden tire damage could also be causing the unusual handling characteristics.

If you suspect that a tire is defective, reduce your speed immediately and have the tires and wheels checked at a qualified specialist workshop.

Notes on regularly inspecting wheels and tires

⚠ WARNING Risk of injury through damaged tires

Damaged tires can cause tire pressure loss.

- ▶ Check the tires regularly for signs of damage and replace any damaged tires immediately.

⚠ WARNING Risk of hydroplaning due to insufficient tire tread

Insufficient tire tread will result in reduced tire grip.

In heavy rain or slush the risk of hydroplaning is increased, in particular where speed is not adapted to suit the conditions.

- ▶ Thus, you should regularly check the tread depth and the condition of the tread across the entire width of all tires.

Minimum tread depth for:

- Summer tires: $\frac{1}{8}$ in (3 mm)
- M+S tires: $\frac{1}{6}$ in (4 mm)

- ▶ For safety reasons, replace the tires before the legally-prescribed limit for the minimum tread depth is reached.

Carry out the following checks on all wheels regularly, at least once a month or as required, for example, prior to a long journey or driving off-road:

- Check the tire pressure (→ page 411).

- Visually inspect wheels and tires for damage.
- Check the valve caps.
- Visually inspect the tire tread depth and the tire contact surface across the entire width.

The minimum tread depth for summer tires is $\frac{1}{8}$ in (3 mm) and for winter tires $\frac{1}{6}$ in (4 mm).

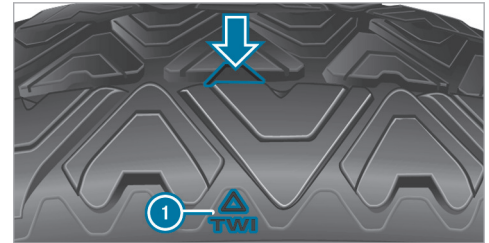

Six marks ① show where the bar indicators (arrow) are integrated into the tire tread. They are visible once a tire tread depth of approximately $\frac{1}{16}$ in (1.6 mm) has been reached.

Notes on snow chains

⚠ WARNING Risk of accident due to incorrectly installed snow chains

If you have installed snow chains on the front wheels, they may drag against the vehicle body or chassis components.

- ▶ Never install snow chains on the front wheels.
- ▶ Only install snow chains on the rear wheels in pairs.

ⓘ NOTE Damage to components of the vehicle body or chassis due to mounted snow chains

If you mount snow chains to the front wheels of 4MATIC vehicles, you may damage components of the vehicle body or chassis.

- ▶ Only mount snow chains to the rear wheels of 4MATIC vehicles.

ⓘ NOTE Damage to wheel trims due to snow chains being installed

If you install snow chains on aluminum wheels you could damage the wheel trims.

- ▶ Remove the wheel trims from the aluminum wheels before installing snow chains.

Observe the following notes when using snow chains:

- Snow chains are only permissible for certain wheel/tire combinations. You can obtain information about this from an authorized Mercedes-Benz Center.
- For safety reasons, only use snow chains that have been specifically approved for your vehicle by Mercedes-Benz, or snow chains with the same quality standard.
- Comply with the installation instructions of the snow chain manufacturer.
- If snow chains are installed, the maximum permissible speed is 30 mph (50 km/h).

- **Vehicles with Active Parking Assist:** do not use Active Parking Assist when snow chains are installed.
 - **Vehicles with AIRMATIC:** if snow chains are installed, only drive at raised vehicle level (→ page 271).
 - **Vehicles with rear axle steering:** if snow chains are installed, only drive with snow chain mode active (→ page 410).
- i** You can deactivate ESP® to pull away (→ page 229). This allows the wheels to spin, achieving an increased driving force.

Activating or deactivating snow chain mode

Multimedia system:



▶ Activate or deactivate **Snow Chain Mode**.

When the function is active, the vehicle behaves as if snow chains were installed. For example, the maximum steering movement of the rear wheels is limited and the turning circle is thus increased.

Additionally, parts of the driving and driving safety systems are not available when snow chain mode is active.

Tire pressure

Notes on tire pressure

⚠ WARNING Risk of accident due to insufficient or excessive tire pressure

Underinflated or overinflated tires pose in particular the following risks:

- The tires can burst.
- The tires can wear excessively and/or unevenly.
- The driving characteristics as well as the steering and braking characteristics may be greatly impaired.

▶ Comply with the recommended tire pressures and check the tire pressure of all tires, including the spare wheel, regularly:

- Monthly
 - When the load changes
 - Before embarking on a longer journey
 - If operating conditions change, e.g. off-road driving
- ▶ Adjust the tire pressure, if necessary.

Tire pressure which is too high or too low can:

- Shorten the service life of the tires.
- Cause increased tire damage.
- Adversely affect driving characteristics and thus driving safety, e.g. due to hydroplaning.

⚠ WARNING Risk of accident due to too low a tire pressure

Tires with pressure that is too low can overheat and burst as a consequence.

In addition, they also suffer from irregular wear, which can significantly impair the braking properties and the handling characteristics.

▶ Avoid excessively low tire pressure.

Tire pressure which is too low can cause:

- Tire defects as a result of overheating
- Impaired handling characteristics
- Irregular wear
- Increased energy consumption

⚠ WARNING Risk of accident due to too high a tire pressure

Tires with excessively high pressure can burst.

In addition, they also suffer from irregular wear, which can significantly impair the braking properties and the handling characteristics.

▶ Avoid excessively high tire pressures.

Tire pressure which is too high can cause:

- Increased braking distance
- Impaired handling characteristics
- Irregular wear
- Impaired driving comfort
- Susceptibility to damage

⚠ WARNING Risk of accident due to repeated pressure drop in the tires

The wheels, valves or tires could be damaged.

Too low a tire pressure can lead to the tires bursting.

- ▶ Examine the tires for foreign objects.
- ▶ Check whether the tire has a puncture or the valve has a leak.
- ▶ If you are unable to rectify the damage, contact a qualified specialist workshop.

You can find information on tire pressure for the vehicle's factory-installed tires on the following labels on the B-pillar on the driver's side:

- Tire and Loading Information placard (→ page 416)
- Tire pressure table (→ page 412).

Observe the maximum tire pressure (→ page 422).

Use a suitable pressure gage to check the tire pressure. The outer appearance of a tire does not

permit any reliable conclusion about the tire pressure.

Only correct tire pressure when the tires are cold. Conditions for cold tires:

- The vehicle has been parked with the tires out of direct sunlight for at least three hours.
- The vehicle has traveled less than 1 mile (1.6 km).

The vehicle's tires heat up when driving. As the temperature of the tires increases, so too does the tire pressure.

Vehicles with a tire pressure monitoring system: you can also see the tire pressure in the driver's display (→ page 415).

The tire pressure recommended for increased load/speed in the tire pressure table can affect the ride comfort.

⚠ WARNING Risk of accident due to unsuitable accessories on tire valves

If you mount unsuitable accessories onto tire valves, the tire valves may be overloaded and

malfunction, which can cause tire pressure loss.

- ▶ Only screw standard valve caps or valve caps specifically approved by Mercedes-Benz for your vehicle onto the tire valve.

Notes on trailer operation

Always inflate the rear axle tires to the recommended tire pressure on the tire pressure table for increased load.

Tire pressure table

The tire pressure table is on the B-pillar on the driver's side.

- ⓘ The data shown in the images is example data.

COLD TIRE PRESSURE			
normal load			
maximum load			
Warm tires up to: + 4 psi			
			A 212 584 00 15 1234567

The tire pressure table shows the recommended tire pressure for all tires approved for this vehicle. The recommended tire pressures apply for cold tires under various operating conditions, i.e. loading and/or speed of the vehicle.

If one or more tire sizes precede a tire pressure, the tire pressure information following is only valid for those tire sizes.

The load conditions "partially laden" and "fully laden" are defined in the table for different numbers of passengers and amounts of luggage. The actual number of seats may differ from this.

		100 kPa = 1 bar			
		kPa ↓ psi		kPa ↓ psi	
R18					
R19					
M+S					
A 213 584 11 05 1234567					

Some tire pressure tables only show the rim diameter instead of the complete tire size, e.g. **R18**. The rim diameter is part of the tire size and can be found on the tire side wall (→ page 423).

Be sure to also observe the following further related subjects:

- Notes on tire pressure (→ page 411)
- Tire and Loading Information placard (→ page 416)

- Maximum tire pressure (→ page 422)

Checking the tire pressure manually

- ▶ Read the tire pressure recommended for the current operating conditions from the tire and loading information placard or the tire pressure table. Observe the notes on tire pressure.
- ▶ Remove the valve cap of the tire to be checked.
- ▶ Press the tire pressure gauge securely onto the valve.
- ▶ Read the tire pressure.
- ▶ If the tire pressure is lower than the recommended value, increase the tire pressure to the recommended value.
- ▶ If the tire pressure is higher than the recommended value, release air. To do so, press down the metal pin in the valve, e.g. using the tip of a pen. Then check the tire pressure again using the tire pressure gauge.
- ▶ Screw the valve cap onto the valve.

Further related subjects:

- Notes on tire pressure (→ page 411)
- Tire pressure table (→ page 412)
- Tire and loading information placard (→ page 416)

Tire pressure monitoring system

Function of the tire pressure monitoring system

⚠ DANGER Risk of accident due to incorrect tire pressure

Each tire, including the spare (if provided), should be checked monthly when cold and inflated to the inflation pressure recommended by the vehicle manufacturer on the vehicle placard or tire inflation pressure label. (If your vehicle has tires of a different size than the size indicated on the vehicle placard or tire inflation pressure label, you should determine the proper tire inflation pressure for those tires.)

As an added safety feature, your vehicle has been equipped with a tire pressure monitoring system (TPMS) that illuminates a low tire pressure telltale when one or more of your tires is significantly under-inflated. Accordingly, when the low tire pressure telltale illuminates, you should stop and check your tires as soon as possible, and inflate them to the proper pressure. Driving on a significantly under-inflated tire causes the tire to overheat and can lead to tire failure. Under-inflation also reduces fuel efficiency and tire tread life, and may affect the vehicle's handling and stopping ability. Please note that the TPMS is not a substitute for proper tire maintenance, and it is the driver's responsibility to maintain correct tire pressure, even if under-inflation has not reached the level to trigger illumination of the TPMS low tire pressure telltale.

Your vehicle has also been equipped with a TPMS malfunction indicator to indicate when the system is not operating properly. The TPMS malfunction indicator is combined with the low tire pressure telltale. When the system

detects a malfunction, the telltale will flash for approximately one minute and then remain continuously illuminated. This sequence will continue upon subsequent vehicle start-ups as long as the malfunction exists.

When the malfunction indicator is illuminated, the system may not be able to detect or signal low tire pressure as intended. TPMS malfunctions may occur for a variety of reasons, including the installation of replacement or alternate tires or wheels on the vehicle that prevent the TPMS from functioning properly.

The system checks the tire pressure and the tire temperature of the tires fitted to the vehicle by means of a tire pressure sensor.

The tire pressure and the tire temperature appear on the driver's display.

If there is a substantial pressure loss or if the tire temperature is excessive, you will be warned with display messages (→ page 519) or the  warning lamp on the driver's display (→ page 538).

The tire pressure monitoring system is only an aid. It is the driver's responsibility to set the tire pressure to the recommended cold tire pressure suitable for the operating situation.

In most cases, the tire pressure monitoring system will automatically update the new reference values after you have changed the tire pressure. You can, however, also update the reference values by restarting the tire pressure monitoring system manually (→ page 415).

System limits

The system may be impaired or may not function particularly in the following situations:

- incorrect reference values were taught in
- sudden pressure loss caused by a foreign object penetrating the tire, for example
- there is a malfunction caused by another radio signal source

Checking the tire pressure with the tire pressure monitoring system

Requirements

- The vehicle is switched on.

Driver's display:



▶ Press **OK** to confirm.

One of the following displays appears:

- Current tire pressure of each wheel:



- **Tire pressure displayed after driving for a few minutes.:** current values are not yet known to the system. The pressure/temperature values of each tire are displayed as soon as they are known to the system.
- **Tire Pressure Monitor Active:** the teach-in process of the system is not yet complete. The tire pressures are already being monitored.

▶ Compare the current tire pressures with the recommended tire pressures for the current operating condition (→ page 412). Additionally, observe the notes on cold tires (→ page 411).

ⓘ The values displayed in the driver's display may deviate from those of the tire pressure gauge as they refer to sea level. At high elevations, the tire pressure values indicated by a tire pressure gauge are higher than those shown in the driver's display.

Bear in mind the following related topic:

- Notes on tire pressure (→ page 411)

Restarting the tire pressure monitoring system

Requirements

- The recommended tire pressure is correctly set for the respective operating status on each of the four wheels (→ page 411).

Restart the tire pressure monitoring system in the following situations:

- The tire pressure has changed.

- The wheels or tires have been changed or newly installed.

Driver's display:

→  → Service

- ▶ Select **Tire Pressure** and confirm with .
- ▶ Swipe downwards on Touch Control on the steering wheel.
The **Use current pressures as new reference values?** message is shown in the driver's display.

- ▶ Select **Yes** and confirm the restart with .
- The **Tire Pressure Monitor Restarted** message is shown in the driver's display.

Current warning messages are deleted and the yellow  warning lamp goes out.

After you have been driving for a few minutes, the system checks whether the current tire pressures are within the specified range. The current tire pressures are then accepted as reference values and monitored.

If the tire pressure levels are not within the specified range, the **Please Correct Tire Pressure** message appears.

Bear in mind the following related topic:

- Notes on tire pressure (→ page 411)

Loading the vehicle

Notes on the Tire and Loading Information placard

 **WARNING** Risk of accident from overloaded tires

Overloaded tires may overheat and burst as a consequence. Overloaded tires can also impair the steering and handling characteristics and lead to brake failure.

- ▶ Observe the load rating of the tires.
- ▶ The load rating must be at least half the permissible axle load of the vehicle.
- ▶ Never overload the tires by exceeding the maximum load.

The Tire and Loading Information placard is on the B-pillar on the driver's side of the vehicle.

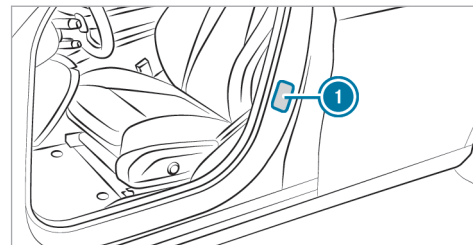

 Tire and Loading Information placard

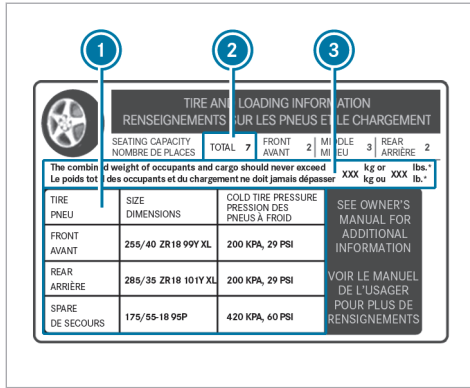

i The data shown in the illustration is example data.

The Tire and Loading Information placard shows the following information:

- Maximum number of seats **(2)** according to the maximum number of people permitted to travel in the vehicle.

- Maximum permissible load **(3)** comprises the gross weight of all vehicle occupants, load and luggage.
- Recommended tire pressures **(1)** for cold tires. The recommended tire pressures are valid for the maximum permissible load and up to the maximum permissible vehicle speed.

Please also note:

- Information on permissible weights and loads on the vehicle identification plate (→ page 441).
- Information on tire pressure in the tire pressure table (→ page 412).

Further related subjects:

- Determining the maximum permissible load (→ page 417)
- Notes on tire pressure (→ page 411).

Steps for Determining Correct Load Limit

The following steps have been developed as required of all manufacturers under Title 49, Code of U.S. Federal Regulations, Part 575, pursuant to

the "National Traffic and Motor Vehicle Safety Act of 1966".

- ▶ **(1):** Locate the statement "The combined weight of occupants and cargo should never exceed XXX kg or XXX lbs." on your vehicle's placard.
- ▶ **(2):** Determine the combined weight of the driver and passengers that will be riding in your vehicle.
- ▶ **(3):** Subtract the combined weight of the driver and passengers from XXX kg or XXX lbs.
- ▶ **(4):** The resulting figure equals the available amount of cargo and luggage load capacity. For example, if the "XXX" amount equals 1,400 lbs. and there will be five 150 lb passengers in your vehicle, the amount of available cargo and luggage load capacity is 650 lbs. (1,400 - 750 (5 x 150) = 650 lbs.)
- ▶ **(5):** Determine the combined weight of luggage and cargo being loaded on the vehicle. That weight may not safely exceed the available cargo and luggage load capacity calculated in Step 4.

▶ (6): If your vehicle will be towing a trailer, load from your trailer will be transferred to your vehicle. Consult this manual to determine how this reduces the available cargo and luggage load capacity of your vehicle.

ⓘ Not all vehicles are permitted to tow a trailer. Towing a trailer is only permitted if a trailer-hitch is installed. Please consult an authorized Mercedes-Benz dealer if you have any questions about towing a trailer with your vehicle.

Even if you have calculated the total load carefully, you should still make sure that the maximum permissible gross weight and the maximum gross axle weight rating of your vehicle are not exceeded. Details can be found on the vehicle identification plate.

Step 1

	Example 1	Example 2
Combined maximum weight of occupants and load (data from the Tire and Loading Information placard)	1500 lbs (680 kg)	1500 lbs (680 kg)

▶ Have your loaded vehicle – including driver, occupants and load – weighed on a vehicle weighbridge. The measured values may not exceed the maximum permissible values stated on the vehicle identification plate.

Further related subjects:

- Calculation example for determining the maximum load (→ page 418)
- Tire and Loading Information placard (→ page 416)
- Tire pressure table (→ page 412)
- Vehicle identification plate (→ page 441)

Calculation example for determining the maximum load

The following table shows examples of how to calculate total and load capacities with varying seating configurations and different numbers and sizes of occupants. The following examples use a maximum load of 1500 lbs (680 kg). **This is for illustration purposes only.** Make sure you are using the actual load limit for your vehicle stated on your vehicle's Tire and Loading Information placard (→ page 416).

The higher the weight of all the occupants, the smaller the maximum load for luggage.

Step 2

	Example 1	Example 2
Number of people in the vehicle (driver and occupants)	5	1
Distribution of the occupants	Front: 2 Rear: 3	Front: 1
Weight of occupants	Occupant 1: 150 lbs (68 kg) Occupant 2: 180 lbs (82 kg) Occupant 3: 160 lbs (73 kg) Occupant 4: 140 lbs (63 kg) Occupant 5: 120 lbs (54 kg)	Occupant 1: 200 lbs (91 kg)
Total weight of all occupants	750 lbs (340 kg)	200 lbs (91 kg)

Step 3

	Example 1	Example 2
Permissible load (maximum gross vehicle weight rating from the Tire and Loading Information placard minus the gross weight of all occupants)	1500 lbs (680 kg) - 750 lbs (340 kg) = 750 lbs (340 kg)	1500 lbs (680 kg) - 200 lbs (91 kg) = 1300 lbs (589 kg)

Tire labeling

Overview of tire labeling

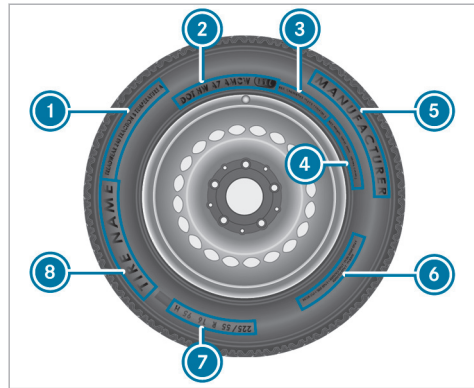

- ① Uniform Tire Quality Grading Standards
- ② DOT (Department of Transportation), (TIN) Tire Identification Number
- ③ Maximum tire load (→ page 422)
- ④ Maximum tire pressure (→ page 422)

- ⑤ Manufacturer
- ⑥ Tire characteristics (→ page 423)
- ⑦ Tire size designation, load-bearing capacity, speed rating and load index (→ page 423)
- ⑧ Tire name
- ⓘ The data shown in the illustration is example data.

Tire Quality Grading

In accordance with the US Department of Transportation's "Uniform tire Quality Grading Standards", tire manufacturers are required to grade their tires on the basis of the following three performance factors:

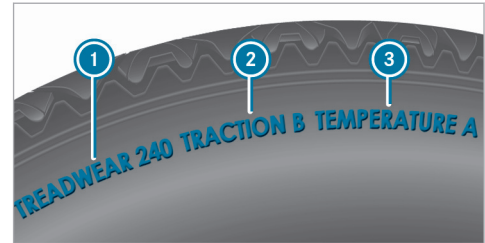

- ① Tread wear grade
- ② Traction grade
- ③ Temperature grade
- ⓘ The data shown in the illustration is example data.
- ⓘ The classification is not legally stipulated for Canada, but it is generally stated.

Tread wear grade

The treadwear grade is a comparative rating based on the wear rate of the tire when tested under controlled conditions on a specified government test course. For example, a tire graded 150 would wear one and one-half (1 1/2) times as

well on the government course as a tire graded 100.

The relative performance of tires depends upon the actual conditions of their use, however, and may depart significantly from the norm due to variations in driving habits, service practices and differences in road characteristics and climate.

Traction grade

⚠ DANGER Risk of accident due to inadequate traction

The traction grade assigned to this tire is based on straight-ahead braking traction tests.

- ▶ Always adapt your driving style and drive at a speed to suit the prevailing traffic and weather conditions.

! NOTE Damage to the drivetrain from wheelspin

- ▶ Avoid wheelspin.

The traction grades, from highest to lowest, are AA, A, B, and C. Those grades represent the tire's ability to stop on wet pavement as measured under controlled conditions on specified government test surfaces of asphalt and concrete. A tire marked C may have poor traction performance.

Temperature grade

⚠ WARNING Risk of accident from tire overheating and tire failure

Excessive speed, underinflation, or excessive loading, either separately or in combination, can cause excessive heat build-up and possible tire failure.

- ▶ Observe the recommended tire pressure.
- ▶ Regularly check the pressure of all the tires.
- ▶ Adjust the tire pressure, if necessary.

The temperature grades are A (the highest), B, and C, representing the tire's resistance to the generation of heat and its ability to dissipate heat when tested under controlled conditions on a specified indoor laboratory test wheel. Sustained

high temperature can cause the material of the tire to degenerate and reduce tire life, and excessive temperature can lead to sudden tire failure. The grade C corresponds to a level of performance which all passenger car tires must meet under the Federal Motor Safety Standard No. 109. Grades B and A represent higher levels of performance on the laboratory test wheel than the minimum required by law.

DOT, Tire Identification Number (TIN)

US tire regulations stipulate that every tire manufacturer or retreader must imprint a TIN in or on the side wall of each tire produced.

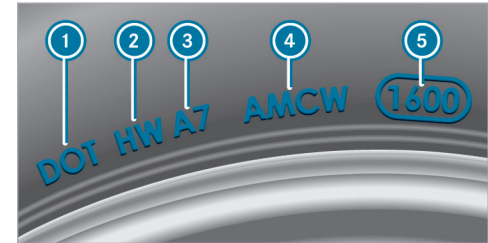

i The data shown in the illustration is example data.

The TIN is a unique identification number to identify tires and comprises the following:

- **DOT (Department of Transportation):** tire symbol marks **1** indicating that the tire complies with the requirements of the US Department of Transportation.
- **Manufacturer identification code:** manufacturer identification code **2** contains details of the tire manufacturer. New tires have a code with two symbols. Retreaded tires have a code with four symbols. Further information on retreaded tires (→ page 427).
- **Tire size:** identifier **3** describes the tire size.
- **Tire type code:** tire type code **4** can be used by the manufacturer as a code to describe specific characteristics of the tire.
- **Manufacturing date:** manufacturing date **5** provides information about the age of a tire. The 1st and 2nd positions represent the calendar week and the 3rd and 4th positions state the year of manufacture (e.g. "3208" represents the 32nd week of 2008).

Information on the maximum tire load



i The data shown in the illustration is example data.

Maximum tire load **1** is the maximum permissible weight for which the tire is approved.

Do not overload the tires by exceeding the specified load limit. The maximum permissible load can be found on the vehicle's Tire and Loading Information placard on the B-pillar on the driver's side (→ page 416).

Specifications for maximum tire pressure

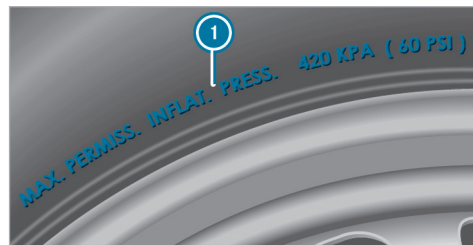

i The data shown in the illustration is example data.

Never exceed maximum tire pressure **1** specified for the tire. Always observe the recommended tire pressure for your vehicle when adjusting the tire pressure (→ page 412).

Information on tire characteristics

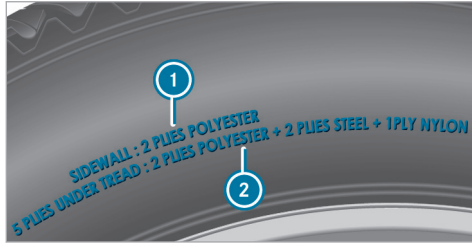

i The data shown in the illustration is example data.

This information describes the type of tire cord and the number of layers in side wall **1** and under tire tread **2**.

Tire size designation, load-bearing capacity, speed rating and load index

⚠ WARNING Risk of injury through exceeding the specified tire load-bearing capacity or the permissible speed rating

Exceeding the specified tire load rating or the permissible speed rating may lead to tire damage and to the tires bursting.

- ▶ Therefore, only use tire types and sizes approved for your vehicle model.
- ▶ Observe the tire load rating and speed rating required for your vehicle.

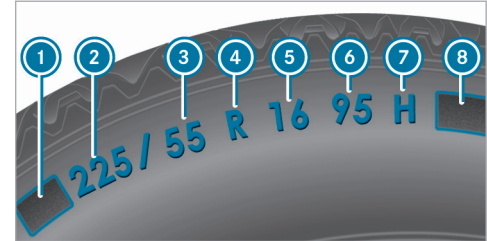

- 1** First letter(s)
- 2** Nominal tire width in millimeters
- 3** Aspect ratio in %
- 4** Tire code
- 5** Rim diameter
- 6** Load-bearing index
- 7** Speed rating
- 8** Load index

i The data shown in the illustration is example data.

Information about reading tire data can be obtained from any qualified specialist workshop.

First letter(s) 1:

- Without: passenger vehicle tires according to European manufacturing standards.
- "P": passenger vehicle tires according to US manufacturing standards.
- "LT": light truck tires according to US manufacturing standards.
- "T": compact emergency spare wheels with high tire pressure that are only designed for temporary use in an emergency.

Aspect ratio 3:

Ratio between tire height and tire width in percent (tire height divided by tire width).

Tire code 4 (tire type):

- "R" radial tire
- "D": bias ply tire
- "B": bias belted tires
- "ZR": radial tire with a maximum speed above 149 mph (240 km/h) (optional)

Rim diameter 5:

The diameter of the bead seat (not the diameter of the rim flange). The rim diameter is specified in inches (in).

Load-bearing index 6:

Numerical code that specifies the maximum load-bearing capacity of a tire (e.g. "91" corresponds to 1,356 lbs (615 kg)).

The load-bearing capacity of the tire must be at least half the gross axle weight rating of your vehicle. Do not overload the tires by exceeding the specified load limit.

See also:

- Maximum permissible load on the Tire and Loading Information placard (→ page 416)
- Maximum tire load (→ page 422)
- Load index

Speed rating 7:

Specifies the approved maximum speed of the tire.

- An electronic speed limiter prevents your vehicle from exceeding a speed of 130 mph (210 km/h).

Make sure that your tires have the required speed rating. You can obtain information on the required speed rating from an authorized Mercedes-Benz Center.

Summer tires

Index	Speed rating
Q	up to 100 mph (160 km/h)
R	up to 106 mph (170 km/h)
S	up to 112 mph (180 km/h)
T	up to 118 mph (190 km/h)
H	up to 130 mph (210 km/h)
V	up to 149 mph (240 km/h)
W	up to 168 mph (270 km/h)
Y	up to 186 mph (300 km/h)

Index	Speed rating
ZR...Y ¹	up to 186 mph (300 km/h)
ZR...(..Y) ¹	over 186 mph (300 km/h)
ZR ¹	over 149 mph (240 km/h)

- Specifying the speed rating as the "ZR" index in tire code ④ is optional for tires up to 186 mph (300 km/h).
- If your tire code ④ includes "ZR" and there is no speed rating ⑦, find out what the maximum speed is from the tire manufacturer.
- If load-bearing index ⑥ and speed rating ⑦ are in brackets, the maximum speed rating of your tire is above 186 mph (300 km/h). To find out the maximum speed, ask the tire manufacturer.

¹ "ZR" stated in the tire code.

² Or "M+S"  " for winter tires.

All-weather tires and winter tires

Index	Speed rating
Q M+S ²	up to 100 mph (160 km/h)
T M+S ²	up to 118 mph (190 km/h)
H M+S ²	up to 130 mph (210 km/h)
V M+S ²	up to 149 mph (240 km/h)

Winter tires bear the  snowflake symbol and fulfill the requirements of the Rubber Manufacturers Association (RMA) and the Rubber Association of Canada (RAC) regarding the tire traction on snow.

Load index ⑧:

- No specification given: standard load (SL) tire
- "XL" or "Extra Load": extra load tire or reinforced tire
- "Light Load": light load tire

- "C", "D", "E": a load range that depends on the maximum load that the tire can carry at a certain pressure

Definition of terms for tires and loading

Tire structure and characteristics: describes the number of layers or the number of rubber-coated belts in the tire contact surface and the tire wall. These are made of steel, nylon, polyester and other materials.

Bar: metric unit for tire pressure. 14.5038 pounds per square inch (psi) and 100 kilopascal (kPa) is the equivalent of one bar.

DOT (Department of Transportation): DOT-marked tires fulfill the requirements of the U.S. Department of Transportation.

Average weight of the vehicle occupants: the number of vehicle occupants for which the vehicle is designed, multiplied by 150 lb (68 kg).

Uniform Tire Quality Grading Standards: a uniform standard to grade the quality of tires with regard

to tread quality, tire traction and temperature characteristics. The quality grading assessment is made by the manufacturer following specifications from the U.S. government. The quality grade of a tire is printed on the side wall of the tire.

Recommended tire pressure: the recommended tire pressure is the tire pressure specified for the tires mounted on the vehicle at the factory.

The tire and information placard contains the recommended tire pressure for cold tires, the maximum permissible load and the maximum permissible vehicle speed.

The tire pressure table contains the recommended tire pressure for cold tires under various operating conditions, i.e. loading and/or speed of the vehicle.

Increased vehicle weight due to optional equipment: the combined weight of all standard and optional equipment available for the vehicle, regardless of whether it is actually installed on the vehicle or not.

Rim: the part of the wheel on which the tire is installed.

GAWR (Gross Axle Weight Rating): the GAWR is the maximum gross axle weight rating. The actual load on an axle must never exceed the gross axle weight rating. The gross axle weight rating can be found on the vehicle identification plate on the B-pillar on the driver's side.

Speed rating: the speed rating is part of the tire identification. It specifies the speed range for which a tire is approved.

GVW (Gross Vehicle Weight): the gross vehicle weight comprises the weight of the vehicle including fuel, tools, the spare wheel, any accessories installed, occupants, luggage and the trailer nose weight, if applicable. The gross vehicle weight must not exceed the gross vehicle weight rating GVWR as specified on the vehicle identification plate on the B-pillar on the driver's side.

GVWR (Gross Vehicle Weight Rating): the GVWR is the maximum permitted gross weight of the fully laden vehicle (weight of the vehicle including all accessories, occupants, fuel, luggage and the trailer drawbar nose weight if applicable). The gross vehicle weight rating is specified on the vehicle identification plate on the B-pillar on the driver's side.

Maximum weight of the laden vehicle: the maximum weight is the sum of the curb weight of the vehicle, the weight of the accessories, the maximum load and the weight of optional equipment installed at the factory.

Kilopascal (kPa): metric unit for tire pressure. 6.9 kPa corresponds to 1 psi. Another unit for tire pressure is bar. 100 kilopascal (kPa) equals 1 bar.

Load index: in addition to the load-bearing index, the load index may also be printed on the side wall of the tire. This specifies the load-bearing capacity of the tire more precisely.

Curb weight: the weight of a vehicle with standard equipment including the maximum capacity of fuel, oil and coolant. It also includes the air conditioning system and optional equipment if these are installed on the vehicle, but does not include passengers or luggage.

Maximum tire load: the maximum tire load is the maximum permissible weight in kilograms or lbs for which a tire is approved.

Maximum permissible tire pressure: maximum permissible tire pressure for one tire.

Maximum load on one tire: maximum load on one tire. This is calculated by dividing the maximum axle load of one axle by two.

PSI (pounds per square inch): standard unit of measurement for tire pressure.

Aspect ratio: ratio between tire height and tire width in percent.

Tire pressure: the pressure inside the tire which applies an outward force to every square inch of the tire. The tire pressure is specified in pounds per square inch (psi), in kilopascals (kPa) or in bar. The tire pressure should only be corrected when the tires are cold.

Cold tire pressure: the tires are cold when the vehicle has been parked for at least 3 hours without direct sunlight on the tires or the vehicle has been driven for less than 1 mile (1.6 km).

Tire contact surface: the part of the tire that comes into contact with the road.

Tire bead: the purpose of the tire bead is to ensure that the tire sits securely on the wheel rim. There are several wire cores in the tire bead to prevent the tire from changing length on the wheel rim.

Side wall: the part of the tire between the tread and the tire bead.

Weight of optional equipment: the combined weight of the optional equipment weighing more than the replaced standard parts and more than 5 lbs (2.3 kg). This optional equipment, such as high-performance brakes, level control system, a roof luggage rack or high-performance batteries, is not included in the curb weight and the weight of the accessories.

TIN (Tire Identification Number): a unique identification number which can be used by a tire manufacturer to identify tires, for example, in a product recall, and thus identify the purchasers. The TIN is made up of the manufacturer's identity code, tire size, tire type code and the manufacturing date.

Load-bearing index: the load-bearing index is a code that contains the maximum load-bearing capacity of a tire.

Traction: traction is the grip resulting from friction between the tires and the road surface.

Wear indicator: narrow bars (tread wear bars) that are distributed over the tire contact surface. If the

tire tread is level with the bars, the wear limit of 1/16 in (1.6 mm) has been reached.

Distribution of vehicle occupants: distribution of vehicle occupants over designated seat positions in a vehicle.

Maximum permissible payload weight: nominal load and luggage load plus 150 lb (68 kg) multiplied by the number of seats in the vehicle.

Changing a wheel

Notes on selecting, installing and replacing tires

! NOTE Mercedes-AMG vehicles

▶ Observe the notes in the Supplement. You could otherwise fail to recognize dangers.

⚠ WARNING Risk of accident due to incorrect wheel and tire dimensions

If wheels and tires of the wrong size are installed, the service brakes or components in the

brake system and in the wheel suspension may be damaged.

- ▶ Always replace wheels and tires with ones that fulfill the specifications of the original part.

For wheels, pay attention to the following:

- Designation
- Type

For tires, pay attention to the following:

- Designation
- Manufacturer
- Type

⚠ WARNING Risk of injury through exceeding the specified tire load-bearing capacity or the permissible speed rating

Exceeding the specified tire load rating or the permissible speed rating may lead to tire damage and to the tires bursting.

- ▶ Therefore, only use tire types and sizes approved for your vehicle model.
- ▶ Observe the tire load rating and speed rating required for your vehicle.

! NOTE Vehicle and tire damage caused by non-approved tire types and sizes

For safety reasons, only use tires, wheels and accessories which have been specially approved by Mercedes-Benz for your vehicle.

These tires are specially adapted to the active safety systems, such as ABS, ESP® and 4MATIC, and marked as follows:

- MO = Mercedes-Benz Original
- MOE = Mercedes-Benz Original Extended (run-flat tires only for certain wheels)
- MO1 = Mercedes-Benz Original (only certain AMG tires)

Otherwise, certain properties, such as handling characteristics, vehicle noise emissions, consumption, etc. could be adversely affected. Furthermore, other tire sizes could result

in the tires rubbing against the body and axle components when loaded. This could result in damage to the tire or the vehicle.

Only use tires, wheels and accessories that have been checked and recommended by Mercedes-Benz.

! NOTE Risk to driving safety from retreaded tires

Retreaded tires are neither tested nor recommended by Mercedes-Benz, since previous damage cannot always be detected on retreaded tires.

For this reason driving safety cannot be guaranteed.

- ▶ Do not use used tires if you have no information about their previous usage.

! NOTE Possible wheel and tire damage when driving over obstacles

Large wheels have a smaller section width. As the section width decreases, the risk of

wheels and tires being damaged when driving over obstacles increases.

- ▶ Avoid obstacles or drive especially carefully.
- ▶ Reduce your speed when driving over curbs, speed bumps, manhole covers and potholes.
- ▶ Avoid particularly high curbs.

! **NOTE** Possible wheel and tire damage when parking on curbs or in potholes

Parking on curbs or in potholes can damage the wheels and tires.

- ▶ Only park on as level a surface as possible.
- ▶ Avoid curbs and potholes when parking.

! **NOTE** Damage to electronic component parts due to the use of tire-installing tools

Vehicles with tire pressure monitoring system: There are electronic component parts in the wheel.

If tire-installing tools are positioned in the area of the valve, the electronic components could be damaged.

- ▶ Tire-installing tools should not be applied in the area of the valve.
- ▶ Always have tires change at a qualified specialist workshop.

! **NOTE** Damage to summer tires at low ambient temperatures

At low ambient temperatures, tears could form when driving with summer tires, causing permanent damage to the tires.

- ▶ At temperatures below 45 °F (7 °C) use  M+S tires.

Accessory parts which are not approved for your vehicle by Mercedes-Benz, or which are not used correctly, can impair the operating safety.

Before purchasing and using non-approved accessories, visit a qualified specialist workshop and inquire about:

- Suitability

- Legal stipulations
- Factory recommendations

! **WARNING** Risk of accident with high performance tires

The special tire tread in combination with the optimized tire compound means that the risk of skidding and hydroplaning on wet roads is increased.

In addition, the tire grip is greatly reduced at a low outside temperature and tire running temperature.

- ▶ Switch on the ESP[®] and adapt your driving style accordingly.
- ▶ Use  M+S tires at outside temperatures of less than 50 °F (10 °C).
- ▶ Only use the tires for their intended purpose.

Observe the following when selecting, installing and replacing tires:

- Furthermore, the use of certain tire types in certain regions and areas of operation can be highly beneficial.
- Only use tires and wheels of the same type (summer tires, winter tires, MOExtended tires) and the same make.
- Only install wheels of the same size (left and right) on each axle.

It is only permissible to install a different wheel size in the event of a flat tire in order to drive to the specialist workshop.

- **Vehicles with a tire pressure monitoring system:** all installed wheels must be equipped with functioning sensors for the tire pressure monitoring system.
- At temperatures below 45°F (7°C) use winter tires or all-season tires marked  M+S for all wheels.

Winter tires provide the best possible grip in wintry road conditions.

- For M+S tires, only use tires with the same tread.
- Observe the maximum permissible speed for the M+S tire which is installed.
If the tire's maximum speed is below that of the vehicle, this must be indicated by an appropriate label in the driver's field of vision.
- Break in new tires at moderate speeds for the first 60 miles (100 km).
- Replace the tires after six years at the latest, regardless of wear.
- **When replacing with tires that do not feature run-flat characteristics:** vehicles with MOExtended tires are not equipped with a TIREFIT kit at the factory. Equip the vehicle with a TIREFIT kit after replacing with tires that do not feature run-flat characteristics, e.g. winter tires.

For more information on wheels and tires, contact a qualified specialist workshop.

Be sure to also observe the following further related subjects:

- Notes on tire pressure (→ page 411)

- Tire and loading information placard (→ page 416)
- Tire size designation, load-bearing capacity, speed rating and load index (→ page 423)
- Tire pressure table (→ page 412)
- Notes on the emergency spare wheel (→ page 438)

Notes on rotating wheels

 **WARNING** Risk of injury through different wheel sizes

Rotating the front and rear wheels can severely impair the driving characteristics. The wheel brakes or suspension components may also be damaged.

 Rotate front and rear wheels only if the wheels and tires are of the same dimensions.

Observe the instructions and safety notes on "Changing a wheel" (→ page 427)

The wear patterns on the front and rear wheels differ:

- Front wheels wear more on the tire shoulder
- Rear wheels wear more in the center of the tire

Do not drive with tires that have too little tread depth. This significantly reduces traction on wet roads (hydroplaning).

On vehicles that have the same size front and rear wheels, rotate the wheels according to the intervals in the tire manufacturer's warranty book in your vehicle documents. If this is not available, rotate the tires every 3,000 to 6,000 miles (5,000 to 10,000 km), depending on the wear. Ensure that the direction of rotation is maintained.

Notes on storing wheels

When storing wheels, observe the following notes:

- After removing wheels, store them in a cool, dry and preferably dark place.
- Protect the tires from contact with oil, grease or fuel.

Overview of the tire-change tool kit

NOTE Mercedes-AMG vehicles

- ▶ Observe the notes in the Supplement. You could otherwise fail to recognize dangers.

Apart from some country-specific variants, vehicles are not equipped with a tire-change tool kit. Consult a qualified specialist workshop to find out which wheel change tools are necessary and approved for changing the wheel on your vehicle.

You will need tools such as the following to change a wheel:

- Jack
- Chock
- Lug wrench
- Alignment bolt

The tire-change tool kit is located in tool bag ① in the cargo compartment.

- ① When stowing the tool bag, make sure that it is adequately secured.

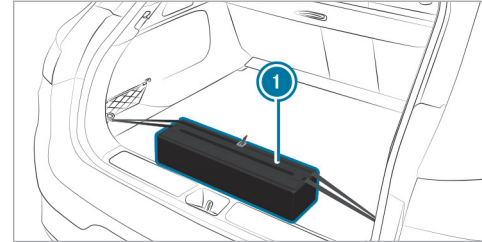

The tool bag contains:

- Jack
- Gloves
- Lug wrench
- Alignment bolt
- Folding chock
- Ratchet for jack

Preparing the vehicle for a wheel change

Requirements

- The vehicle is not on a slope.

- The vehicle is on solid, non-slippery and level ground.
 - The required tire-change tool kit is available.
- ❗ If your vehicle is not equipped with the tire-change tool kit, consult a qualified specialist workshop to find out about suitable tools.
- ▶ Apply the electric parking brake manually.
 - ▶ Move the front wheels to the straight-ahead position.
 - ▶ Shift the transmission to position **P**.
 - ▶ **Vehicles with AIRMATIC:** set the raised vehicle level for greater ground clearance (→ page 271).
 - ▶ Switch off the vehicle.
 - ▶ Make sure that the vehicle cannot be started.
 - ▶ Place chocks or other suitable items under the front and rear of the wheel that is diagonally opposite the wheel you wish to change.
 - ▶ Unload the vehicle.

Removing and installing the wheel trim/hub caps

Requirements

- The vehicle is prepared for a wheel change (→ page 431).

Multi-piece wheel trim

On vehicles with aluminum wheels, the trim parts may be damaged when the wheel is changed.

Before unscrewing the wheel bolts, remove the multi-piece wheel trim.

- ▶ **To remove:** using both hands, carefully reach into two wheel trim openings and remove the wheel trim.
- ▶ **To install:** place the wheel trim in position and press firmly until it engages.

Raising the vehicle when changing a wheel

Requirements

- There are no persons in the vehicle.
- The vehicle has been prepared for a wheel change (→ page 431).

Important notes on using the jack:

- Use only a vehicle-specific jack that has been approved by Mercedes-Benz to raise the vehicle.
- The jack is only designed for raising and holding the vehicle for a short time while a wheel is being changed and not for maintenance work under the vehicle.
- The jack must be placed on a firm, flat and non-slip surface. If necessary, use a large, flat, load-bearing, non-slip underlay.
- The foot of the jack must be positioned vertically under the jack support point.

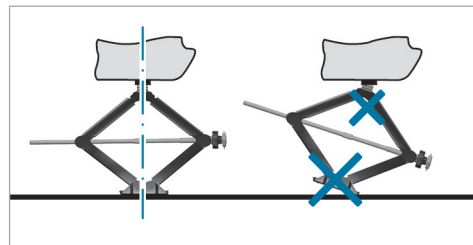

Rules of conduct when the vehicle is raised:

- Never place your hands or feet under the vehicle.
- Never lie under the vehicle.
- Do not start the vehicle and do not release the electric parking brake.
- Do not open or close any doors or the tailgate.

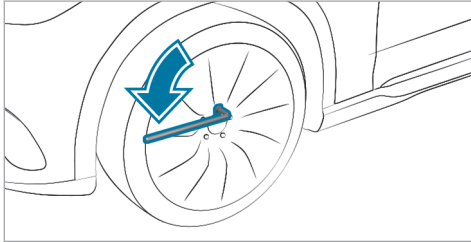

- ▶ Using the wheel wrench, loosen the wheel bolts on the wheel you wish to change by about one full turn. Do not unscrew the screws completely.

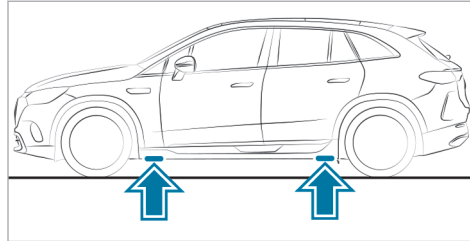

Position of the jack support points

! NOTE Mercedes-AMG vehicles

- ▶ Observe the notes in the Supplement. You could otherwise fail to recognize dangers.

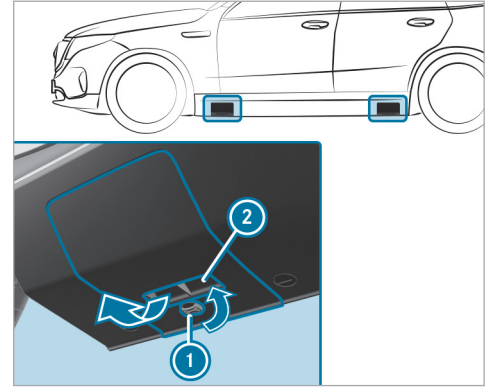

Cover of the jack support points

Before positioning the jack, you must remove the covers for the jack support points.

- ▶ **To remove:** turn clip ① on the cover one quarter turn and remove.
- ▶ Pull the cover downwards using handle ② until the cover releases at the top of the longitudinal member panel.

- ▶ Remove the cover.

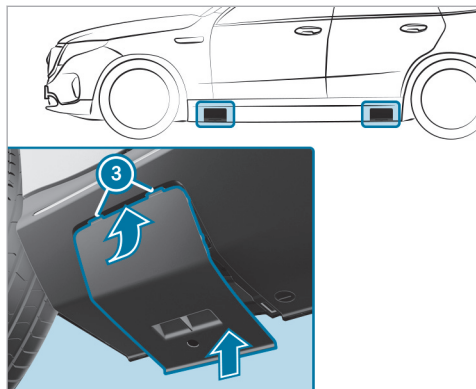

Cover of the jack support points

- ▶ **To install:** insert tabs ③ of the cover into the recesses of the longitudinal member panel and press the covers closed.

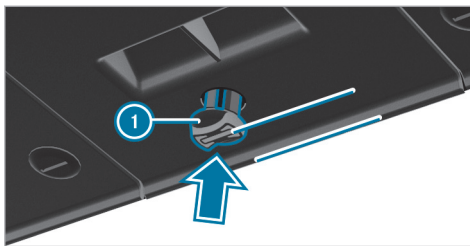

- ▶ Insert retaining clip ① into the cover, as shown in the illustration, until you hear it engage in the floor bush. Make sure that the floor bush in the vehicle is correctly aligned to the cover.

! **NOTE** Damage to the vehicle due to using an unsuitable jack

You can damage the vehicle and, in particular, the high-voltage battery if you use a jack that is not specifically designed for the jack support points of the vehicle.

- ▶ Only use jacks that are specifically designed for the jack support points, or use an appropriate adapter.

! **NOTE** Risk of damage to the vehicle due to incorrect positioning of the jack

If you do not position the jack at the designated jack support points, you could damage your vehicle and, in particular, the high-voltage battery.

- ▶ Only position the jack at the designated jack support points.

- ▶ Take the ratchet out of the tire-change tool kit and place it on the hexagon nut of the jack so that the letters "AUF" are visible.

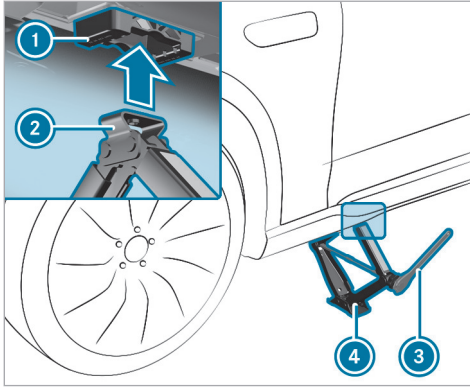

- ▶ Position support ② of jack ④ on jack support point ①.
- ▶ Turn ratchet ③ clockwise until support ② sits completely on jack support point ① and the base of the jack lies evenly on the ground.
- ▶ Turn ratchet ③ until the tire is raised a maximum of 1.2 in (3 cm) from the ground.
- ▶ Loosen and remove the wheel (→ page 435).

Removing a wheel

Requirements

- The vehicle is raised.

! NOTE Mercedes-AMG vehicles

- ▶ Observe the notes in the Supplement. You could otherwise fail to recognize dangers.

When changing a wheel, avoid applying any force to the brake discs, as this could impair the level of comfort when braking.

! NOTE Damage to the wheels' plastic elements when changing a wheel

Plastic elements on wheels may be damaged when removing and repositioning the wheel.

- ▶ Do not raise the wheels by the plastic elements when removing and repositioning.

! NOTE Damage to threading from dirt on wheel bolts

- ▶ Do not place wheel bolts in sand or on a dirty surface.

- ▶ Unscrew the uppermost wheel bolt completely.

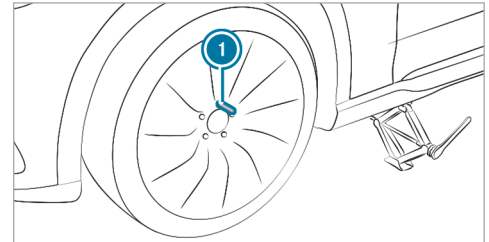

- ▶ Screw centering pin ① into the thread instead of the wheel bolt.
- ▶ Unscrew the remaining wheel bolts completely.
- ▶ Remove the wheel.

Installing a new wheel

Requirements

- The wheel to be changed is removed and the alignment bolt is screwed in (→ page 435).

! NOTE Mercedes-AMG vehicles

- ▶ Observe the notes in the Supplement. You could otherwise fail to recognize dangers.

! WARNING Risk of accident from losing a wheel

Oiled, greased or damaged wheel bolt/wheel nut threads or wheel hub/wheel mounting bolt threads can cause the wheel bolts/wheel nuts to come loose.

- ▶ Never oil or grease the threads.
- ▶ In the event of damage to the threads, contact a qualified specialist workshop immediately.
- ▶ Have the damaged wheel bolts or damaged hub threads replaced.

- ▶ Do not continue driving.

- ▶ Observe the information on the choice of tires (→ page 427).

For tires with a specified direction of rotation, an arrow on the side wall of the tire indicates the correct direction of rotation. Observe the direction of rotation when installing.

! NOTE Damage to the wheels' plastic elements when changing a wheel

Plastic elements on wheels may be damaged when removing and repositioning the wheel.

- ▶ Do not raise the wheels by the plastic elements when removing and repositioning.
- ▶ Slide the wheel to be mounted onto the alignment bolt and push it on.

! WARNING Risk of injury from tightening wheel bolts and nuts

If you tighten the wheel bolts or wheel nuts when the vehicle is raised, the jack could tip.

- ▶ Only tighten wheel bolts or wheel nuts when the vehicle is on the ground.

- ▶ Be sure to observe the instructions and safety notes on "Changing a wheel" (→ page 427).
- ▶ For safety reasons, only use wheel bolts which have been approved by Mercedes-Benz and for the wheel in question.

! NOTE Damage to paintwork of the wheel rim when screwing in the first wheel bolt

If the wheel has too much play when screwing in the first wheel bolt, the wheel rim paint can be damaged.

- ▶ Press the wheel firmly against the wheel hub when screwing in the first wheel bolt.

- ▶ Tighten the wheel bolts evenly in a diagonal pattern in the order indicated until they are finger-tight.
- ▶ Unscrew and remove the alignment bolt.
- ▶ Tighten the last wheel bolt until it is finger-tight.
- ▶ Lower the vehicle (→ page 437).

Lowering the vehicle after a wheel change

Requirements

- The new wheel has been installed (→ page 436).

! **NOTE** Risk of vehicle jack becoming trapped by the AIRMATIC system

If the AIRMATIC system has released air when raising the vehicle, the jack can become trapped when the vehicle is lowered.

- ▶ Start the drive system. This adapts the vehicle level.
- ▶ Remove the jack from under the vehicle.

- ▶ **To lower the vehicle:** place the ratchet onto the hexagon nut of the jack so that the letters "AB" are visible and turn counter-clockwise.

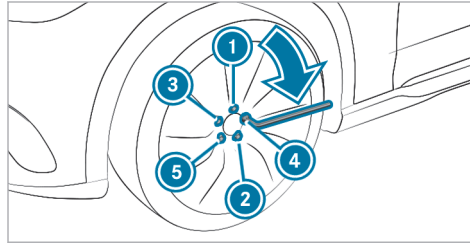

- ▶ Tighten the wheel bolts evenly in a diagonal pattern in the order indicated ① to ⑤ with an initial maximum force of 59 lb-ft (80 Nm).
- ▶ Tighten the wheel bolts evenly in a diagonal pattern in the order indicated ① to ⑤ with the specified tightening torque of 111 lb-ft (150 Nm).

! **WARNING** Risk of accident due to incorrect tightening torque

The wheels could come loose if the wheel bolts or wheel nuts are not tightened to the prescribed torque.

- ▶ Ensure that the wheel bolts or wheel nuts are tightened to the prescribed tightening torque.
- ▶ If you are not sure, do not move the vehicle. Contact a qualified specialist workshop and have the tightening torque checked immediately.

- ▶ Check the tire pressure of the newly installed wheel and adjust it if necessary.

i The following does not apply if the new wheel is an emergency spare wheel.

- ▶ **Vehicles with a tire pressure monitoring system:** restart the tire pressure monitoring system (→ page 415).

Emergency spare wheel

Notes on the emergency spare wheel

⚠ WARNING Risk of accident caused by incorrect wheel and tire dimensions

The wheel or tire sizes and the tire type of the emergency spare wheel or spare wheel and the wheel to be replaced may differ. The emergency spare wheel or spare wheel can significantly impair driving characteristics of the vehicle.

To prevent hazardous situations:

- ▶ Drive carefully.
- ▶ Never install more than one emergency spare wheel or spare wheel that differs in size.
- ▶ Only use an emergency spare wheel or spare wheel briefly.
- ▶ Do not deactivate ESP®.
- ▶ Have the emergency spare wheel or spare wheel of a different size replaced at the nearest qualified specialist work-

shop. The new wheel must have the correct dimensions.

Observe the following notes on installing an emergency spare wheel:

- The maximum permissible speed with an emergency spare wheel installed is 50 mph (80 km/h).
 - Do not install the emergency spare wheel with snow chains.
 - Replace the emergency spare wheel after six years at the latest, regardless of wear.
 - Use the wheel bolts that are included with the emergency spare wheel.
 - Check the tire pressure of the emergency spare wheel installed. Correct the pressure as necessary.
- i** The specified tire pressure is stated on the label of the emergency spare wheel.
- i** **Vehicles with a tire pressure monitoring system:** if an emergency spare wheel is installed, the tire pressure monitoring system cannot function reliably. For a few minutes after an

emergency spare wheel is installed, the system may still display the tire pressure of the removed wheel. Only restart the system again when the emergency spare wheel has been replaced with a new wheel.

Be sure to also observe the following further related subjects:

- Notes on tire pressure (→ page 411)
- Tire and loading information placard (→ page 416)
- Tire pressure table (→ page 412)
- Notes on installing tires (→ page 427)
- Installing an emergency spare wheel (→ page 431)

Notes on technical data

! NOTE Mercedes-AMG vehicles

- ▶ Observe the notes in the Supplement. You could otherwise fail to recognize dangers.

The data stated only applies to vehicles with standard equipment. You can obtain further information from an authorized Mercedes-Benz Center.

Vehicle electronics

Two-way radios

Notes on installing two-way radios

! WARNING Risk of accident due to improper work on two-way radios

If two-way radios are manipulated or retrofitted incorrectly, the electromagnetic radiation from the two-way radios can interfere with the vehicle electronics and jeopardize the operating safety of the vehicle.

- ▶ You should have all work on electrical and electronic components carried out at a qualified specialist workshop.

! WARNING Risk of accident due to improper operation of two-way radios

If you use two-way radios in the vehicle improperly, their electromagnetic radiation can disrupt the vehicle's electronics. This is the case in the following situations, in particular:

- The two-way radio is not connected to an exterior antenna.
- The exterior antenna is installed incorrectly or is not a low-reflection antenna.

This could jeopardize the operating safety of the vehicle.

- ▶ Have the low-reflection exterior antenna installed at a qualified specialist workshop.

- ▶ When operating two-way radios in the vehicle, always connect them to the low-reflection exterior antenna.

! NOTE Invalidation of the operating permit due to failure to comply with the instructions for installation and use

The operating permit may be invalidated if the instructions for installation and use of two-way radios are not observed.

- ▶ Only use approved frequency bands.
- ▶ Observe the maximum permissible output power in these frequency bands.
- ▶ Only use approved antenna positions.

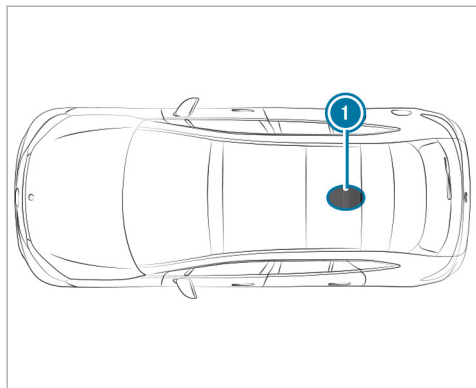

① Rear roof area

On vehicles with a panorama roof with power tilt/sliding panel, installing an antenna is not permitted.

Use Technical Specification ISO/TS 21609 (Road Vehicles - "EMC guidelines for installation of aftermarket radio frequency transmitting equipment") when retrofitting two-way radios. Comply with the legal requirements for detachable parts.

If your vehicle has a pre-installation for two-way radio equipment, use the power supply and antenna connectors provided in the pre-installation. Observe the manufacturer's supplements when installing.

■ Two-way radio transmission output

The maximum transmission output (PEAK) at the base of the antenna must not exceed the values in the following table.

Frequency band and maximum transmission output

Frequency band	Maximum transmission output
2-m- frequency band 144 - 174 MHz	50 W
Terrestrial Trunked Radio (TETRA) 380 - 460 MHz	10 W

Frequency band	Maximum transmission output
Two-way radio 2G	2 W
Two-way radio 3G/4G/5G	0.5 W

The following devices can be used in the vehicle without restrictions:

- two-way radios with a maximum transmission output of up to 100 mW
- two-way radios with transmitter frequencies in the 380 - 420 MHz frequency band and a maximum transmission output of up to 2 W (TETRA)
- mobile phones (2G/3G/4G/5G)

There are no restrictions on positioning the antenna on the outside of the vehicle for the following frequency bands:

- TETRA
- 2G/3G/4G/5G

Radio regulations

Regulatory radio identification and specific notes

Manufacturer information about radio-based vehicle components can be found using the key phrase "Regulatory radio information" in the Digital Operator's Manual in the vehicle, on the internet and in the app.

Further information and updates are available at the following web address:

<https://regulatoryradioinformation.corpinter.net/us>

Vehicle identification plate, VIN and engine number overview

Vehicle identification plate

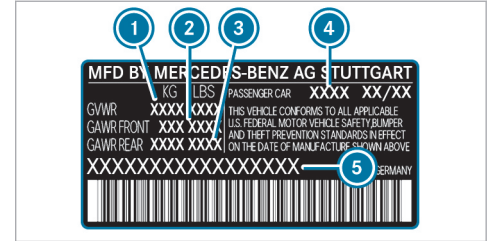
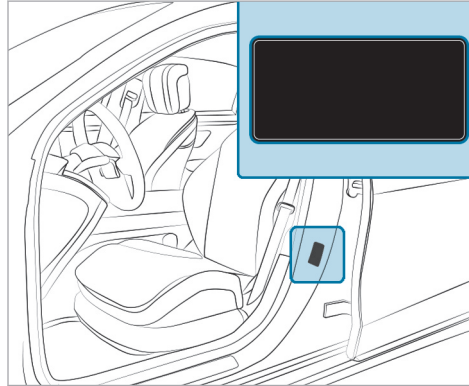

Vehicle identification plate (USA only)

- ① Maximum permissible gross vehicle mass
- ② Maximum permissible front axle load
- ③ Maximum permissible rear axle load
- ④ Paint code
- ⑤ VIN (vehicle identification number)

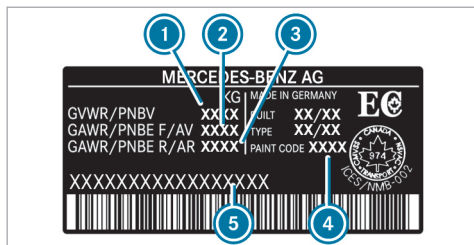

Vehicle identification plate (Canada only)

- ① Maximum permissible gross vehicle mass
- ② Maximum permissible front axle load
- ③ Maximum permissible rear axle load
- ④ Paint code
- ⑤ VIN (vehicle identification number)

The permissible gross vehicle weight is made up of the vehicle weight, all vehicle occupants and the load. The maximum gross axle weight rating is the maximum weight that can be carried on one axle (front- or rear axle).

Do not exceed the maximum permissible gross vehicle weight or the maximum gross axle weight rating for the front- or rear axle.

VIN below the front right-hand seat

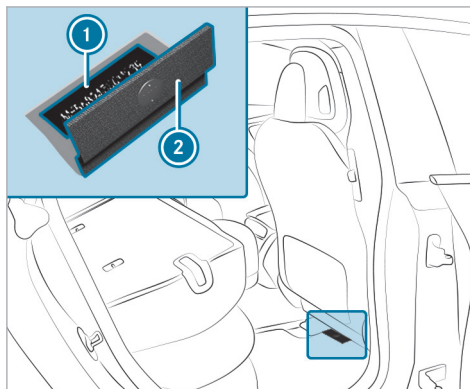

- ① Imprinted VIN (vehicle identification number)
- ② Floor covering

VIN at the lower edge of the windshield

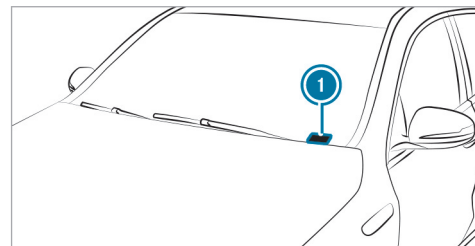

- ① VIN (vehicle identification number) as label

Operating fluids

Notes on operating fluids

⚠ WARNING Risk of injury due to harmful operating fluids

Operating fluids can be toxic.

- ▶ When using, storing and disposing of operating fluids, observe the imprints on the respective original containers.

- ▶ Always keep operating fluids in the sealed original container.
- ▶ Always keep children away from operating fluids.

 **ENVIRONMENTAL NOTE** Pollution of the environment due to irresponsible disposal of operating fluids

Incorrect disposal of operating fluids can cause considerable damage to the environment.

- ▶ Dispose of operating fluids in an environmentally responsible manner.

Operating fluids include the following:

- lubricants
- coolant
- brake fluid
- windshield cleaning agent
- climate control system refrigerant

Only use products approved by Mercedes-Benz. Damage caused by the use of products that have

not been approved in the vehicle is not covered by the Mercedes-Benz warranty or goodwill gestures.

You can identify operating fluids approved by Mercedes-Benz by the following inscriptions on the container:

- MB-Freigabe (e.g. MB-Freigabe 229.51)
- MB-Approval (e.g. MB-Approval 229.51)

Further information on approved operating fluids is available at the following locations:

- in the Mercedes-Benz Specifications for Operating Fluids by entering the designation
 - at <https://operatingfluids.mercedes-benz.com>
- at a qualified specialist workshop

Notes on brake fluid

Observe the notes on operating fluids (→ page 442).

 **WARNING** Risk of an accident due to vapor pockets forming in the brake system

The brake fluid constantly absorbs moisture from the air. This lowers the boiling point of the brake fluid. If the boiling point is too low, vapor pockets may form in the brake system when the brakes are applied hard.

This causes the braking effect to be impaired.

- ▶ Have the brake fluid renewed at the specified intervals.

Have the brake fluid regularly replaced at a qualified specialist workshop.

Only use a brake fluid approved by Mercedes-Benz according to MB-Freigabe or MB-Approval 331.0.

Coolant

Notes on coolant

Observe the notes on operating fluids (→ page 442).

⚠ WARNING Risk of fire- and injury from antifreeze

If antifreeze comes into contact with hot component parts in the engine compartment, it may ignite.

- ▶ Allow the drive system to cool down before you add antifreeze.
- ▶ Make sure that no antifreeze spills out next to the filler opening.
- ▶ Thoroughly clean the antifreeze from component parts before starting the vehicle.

! NOTE Damage caused by incorrect coolant

- ▶ Only use coolant that has been premixed with the required antifreeze protection.

Information on coolant is available at the following locations:

- In the Mercedes-Benz Specification for Operating Fluids 320.1

- At <https://operatingfluids.mercedes-benz.com>
- At a qualified specialist workshop

! NOTE Overheating at high outside temperatures

If an inappropriate coolant is used, the cooling system is not sufficiently protected against overheating and corrosion at high outside temperatures.

- ▶ Only use coolant approved for Mercedes-Benz.
- ▶ Observe the instructions in the Mercedes-Benz Specifications for Operating Fluids 320.1.

Have the coolant regularly replaced at a qualified specialist workshop.

Proportion of antifreeze concentrate in the cooling system:

- A minimum of 50% (antifreeze protection down to about -35°F (-37°C))

- A maximum of 55% (antifreeze protection down to -49°F (-45°C))

■ Coolant filling capacity

Coolant (drive system cooling circuit)

Model	Capacity
EQE 350	11.6 US qt (11 liters)
EQE 350 4MATIC	12.7 US qt (12 liters)
EQE 500 4MATIC	

Coolant (high-voltage battery cooling circuit)

Model	Capacity
All models	13.7 US qt (13 liters)

Notes on windshield washer fluid

Observe the notes on operating fluids (→ page 442).

⚠ WARNING Risk of fire and injury from windshield washer concentrate

Windshield washer concentrate is highly flammable. If it comes into contact with hot components, it may ignite.

- ▶ Make sure that windshield washer concentrate is not spilled near to the filler opening.

! NOTE Damage to the exterior lighting due to unsuitable windshield washer fluid

Unsuitable windshield washer fluid may damage the plastic surface of the exterior lighting.

- ▶ Only use windshield washer fluid which is also suitable for use on plastic surfaces, e.g. MB SummerFit or MB WinterFit.

! NOTE Blocked spray nozzles caused by mixing windshield washer fluids

- ▶ Do not mix MB SummerFit and MB WinterFit with other windshield washer fluids.

Do not use distilled or de-ionized water. Otherwise, the fill level sensor may be triggered erroneously.

Recommended windshield washer fluid:

- above freezing point: e.g. MB SummerFit
- below freezing point: e.g. MB WinterFit

For the correct mixing ratio, refer to the information on the antifreeze container.

Mix washer fluid with windshield washer fluid all year round.

Refrigerant

Notes on refrigerant

Observe the notes on operating fluids (→ page 442).

! NOTE Damage due to incorrect refrigerant

If a non-approved refrigerant is used, the climate control system may be damaged.

- ▶ Use only R-1234yf refrigerant.

! NOTE Damage to the climate control system due to incorrect refrigerant compressor oil

- ▶ Only use refrigerant compressor oil that has been approved by Mercedes-Benz.
- ▶ Do not mix the approved refrigerant compressor oil with a different refrigerant compressor oil.

Work on the climate control system may be carried out only at a qualified specialist workshop. All applicable regulations as well as SAE standard J639 must be adhered to.

The information label for the climate control system regarding the refrigerant type and the refrigerant compressor oil (PAG oil) is located on the inside of the hood.

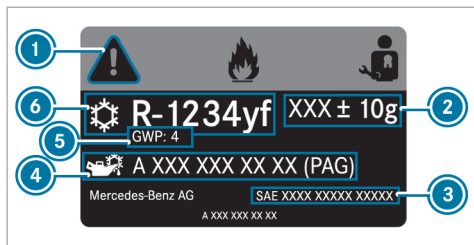

Information label

- ① Hazard and service warning symbols
- ② Refrigerant filling capacity
- ③ Applicable standards
- ④ PAG oil part number
- ⑤ GWP (global warming potential) of the refrigerant used
- ⑥ Refrigerant type

Symbols ① indicate the following:

- Possible dangers
- Having maintenance work carried out at a qualified specialist workshop

Filling capacity for refrigerant and PAG oil

Refrigerant filling capacity

Model	
All models	31.4 ± 0.4 oz (890 ± 10 g)

Filling capacity for PAG oil

Model	
All models	5.6 ± 0.4 oz (160 ± 10 g)

Vehicle data

Vehicle dimensions

The heights specified may vary as a result of the following factors:

- Tires
- Load
- Condition of the suspension
- Optional equipment

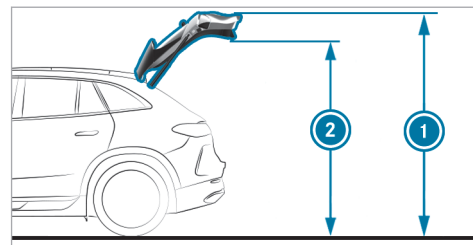

- ① Height when opened
- ② Height

Height when open and height

Model	① Height when opened	② Height
All models	86.1 in (2188 mm)	75.9 in (1929 mm)

Vehicle dimensions

All models	
Vehicle length	191.5 in (4863 mm)
Vehicle width including exterior mirrors	84.3 in (2141 mm)
Vehicle height	66.3 in (1685 mm)
Wheelbase	119.3 in (3030 mm)
Turning circle	34.5 ft (10.5 m)
Maximum ground clearance (vehicles with steel suspension)	7.1 in (181 mm)
Minimum ground clearance (vehicles with steel suspension)	5.2 in (131 mm)

Weights and loads

Bear in mind that items of optional equipment increase the curb weight and reduce the payload.

Vehicle-specific weight information can be found on the vehicle identification plate.

Off-road driving

Also observe the notes on driving off-road, driving in mountainous terrain and fording (→ page 188).

Fording

! **NOTE** Damage caused by water when fording

In the following cases water can penetrate into the engine compartment and vehicle interior:

- The maximum permissible fording depth is exceeded when driving through standing water.
- When driving through the water a bow wave forms.
- Water accumulates when driving through running water.

▶ Do not exceed the maximum permissible fording depth and drive slowly through the water.

The specified value indicates the maximum permissible fording depth for vehicles that are in roadworthy condition and for slow driving through standing water.

Driving through flowing water reduces the permissible fording depth due to the accumulation of water.

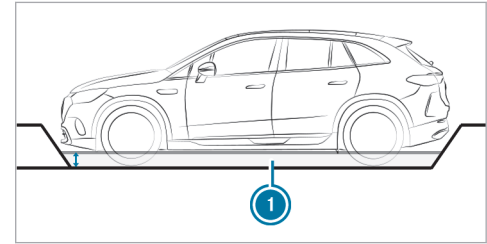

Fording depth

Model	1 Fording depth
All models	11.8 in (30 cm)

Notes on the angle of approach/departure

The specified values are maximum values for vehicles that are in ready-to-drive loading condition.

On vehicles with AIRMATIC, loads up to the maximum payload have no influence on the approach/departure angles.

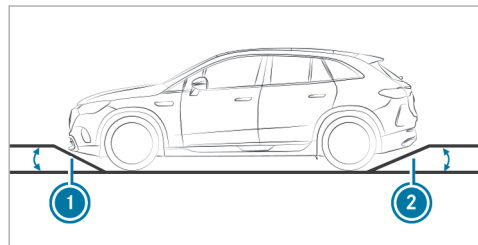
**Angle of approach/departure**

Model	① Front	② Rear
All models	18°	22.6°

High-voltage battery

Missing values were not available at the time of going to press.

Energy content and charging times (EQE 350 4MATIC)

EQE 350 4MATIC	
Type	Lithium-ion
Usable energy content	89 kWh
Range	
Charging time – mode 4 with max. 170 kW charging capacity	Approx. 32 min
Charging time – mode 3 with 9.6 kW charging capacity	Approx. 10 h 45 min

Energy content and charging times (EQE 350 and EQE 500 4MATIC)

EQE 350 EQE 500 4MATIC	
Type	Lithium-ion
Usable energy content	90.56 kWh
Range	
Charging time – mode 4 with max. 170 kW charging capacity	Approx. 32 min
Charging time – mode 3 with 9.6 kW charging capacity	Approx. 10 h 45 min

–Mode 3 charging time applies to AC charging from 0 % to 100 % of the usable energy content. Charging time –mode 4 applies to DC charging from 10 % to 80 % of the usable energy content.

The time taken to charge the battery depends on the state of charge of the battery, the ambient temperature and the charging capacity of the battery. The charging capacity, in turn, depends on the supply voltage, the current intensity and the type of power supply.

The nominal voltage range for your vehicle can be found on the information label in the socket cover (→ page 200).

Trailer hitch

General notes on the trailer hitch

Modifications to the cooling system may be necessary, depending on the vehicle model. Retrofitting a trailer hitch is permissible only if a trailer load is specified in your vehicle documents.

Further information can be obtained at a qualified specialist workshop.

Observe the information and notes on the trailer hitch (→ page 303).

Mounting dimensions of the trailer hitch

Missing values were not available at the time of going to press.

Overhang dimension length

Model	Overhang dimension
All models	

Towing capacity

The drawbar load is not included in the towing capacity.

Missing values were not available at the time of going to press.

Towing capacity, braked (at a minimum start-off gradeability of 12 %)

Model	Towing capacity, braked
All models	

Towing capacity, unbraked

Model	Towing capacity, unbraked
All models	

Maximum tongue weight and load capacity

! **NOTE** Damage caused by the trailer coming loose

If the tongue weight used is too low, the trailer may come loose.

- ▶ The tongue weight must not be below 110.2 lbs (50 kg).
- ▶ Use a tongue weight that is as close as possible to the maximum permissible tongue weight.

! **NOTE** Damage caused by the bicycle rack coming loose

When using a bicycle rack, both the maximal tongue weight and the maximal load capacity should be observed.

450 Technical data

▶ Do not exceed the permissible load capacity.

Missing values were not available at the time of going to press.

Tongue weight

Model	Maximum tongue weight
All models	

Load capacity

Model	Maximum load capacity
All models	

Axle load when towing trailer

Model	Axle load
All models	

Gross axle weight rating, rear axle

Missing values were not available at the time of going to press.

Display messages

Introduction



Information about display messages



Display messages appear on the driver's display.

Display messages with graphical symbols are simplified in the Operator's Manual and may differ from the symbols on the driver's display. The driver's display shows high-priority display messages in red. Certain display messages are accompanied by a warning tone.

Please act in accordance with the display messages and follow the additional notes in the Operator's Manual.

For some display messages, symbols will also be shown:

-  Further information
-  Hide display message

With the left-hand Touch Control, you can select the respective symbol by swiping to the left or right. Pressing  displays further information on the central display. Press the  symbol to hide the display message.

Display messages to be acknowledged can be hidden by pressing the back button  or with the left-hand Touch Control. The display messages will then be stored in the message memory.

Rectify the cause of a display message as quickly as possible.

High-priority display messages cannot be hidden. The driver's display will show these display messages continuously until the cause of the display message has been rectified.

Calling up saved display messages



Driver's display:

Service

The **Message Memory: XX** message appears on the driver's display.

- ▶ Scroll through the display messages by swiping upwards or downwards on the left-hand Touch Control.
- ▶ **To exit the display:** press the  back button.

Occupant safety

Display messages	Possible causes/consequences and ► Solutions
 <p data-bbox="144 381 413 433">Restraint System Malfunction Service Required</p>	<p data-bbox="476 288 1005 314">* The restraint system is malfunctioning (→ page 47).</p> <div data-bbox="500 332 1646 570" style="border: 1px solid gray; padding: 5px;"> <p data-bbox="506 339 1193 366">⚠ DANGER Risk of death due to the restraint system malfunctioning</p> <p data-bbox="506 381 1609 433">Components in the restraint system may be activated unintentionally or not deploy as intended in an accident. In the event of an accident, the high-voltage on-board electrical system may not be deactivated as intended. You may receive an electric shock if you touch the damaged components of the high-voltage on-board electrical system.</p> <ul data-bbox="506 501 1471 560" style="list-style-type: none"> <li data-bbox="506 501 1471 526">► Have the restraint system checked and repaired immediately at a qualified specialist workshop. <li data-bbox="506 532 1060 560">► After an accident, switch off the vehicle immediately. </div>
 <p data-bbox="144 681 413 733">Front Left Malfunction Service Required (example)</p>	<p data-bbox="476 588 1005 615">* The restraint system is malfunctioning (→ page 47).</p> <div data-bbox="500 632 1646 860" style="border: 1px solid gray; padding: 5px;"> <p data-bbox="506 640 1193 667">⚠ DANGER Risk of death due to the restraint system malfunctioning</p> <p data-bbox="506 681 1609 733">Components in the restraint system may be activated unintentionally or not deploy as intended in an accident. In the event of an accident, the high-voltage on-board electrical system may not be deactivated as intended. You may receive an electric shock if you touch the damaged components of the high-voltage on-board electrical system.</p> <ul data-bbox="506 801 1471 860" style="list-style-type: none"> <li data-bbox="506 801 1471 826">► Have the restraint system checked and repaired immediately at a qualified specialist workshop. <li data-bbox="506 832 1060 860">► After an accident, switch off the vehicle immediately. </div>



Display messages	Possible causes/consequences and ► Solutions
 <p data-bbox="194 341 443 424">Left Window Airbag Malfunction Service Required (example)</p>	<p data-bbox="526 248 1053 274">* The restraint system is malfunctioning (→ page 47).</p> <div data-bbox="545 290 1690 429" style="border: 1px solid gray; padding: 5px;"> <p data-bbox="554 295 1469 326">▲ WARNING Risk of injury or fatal injury due to a malfunction in the window curtain airbag</p> <p data-bbox="554 336 1635 388">The window curtain airbag might be triggered unintentionally or might not be triggered at all in the event of an accident.</p> <p data-bbox="554 398 1580 424">► Have the window curtain airbag checked and repaired immediately at a qualified specialist workshop.</p> </div>
<p data-bbox="194 450 480 528">Front Passenger Airbag Disabled See Operator's Manual</p>	<p data-bbox="526 450 1690 528">* The front passenger air bag and the front passenger knee air bag have been disabled even though an adult or a person of adult build is on the front passenger seat. If additional forces are applied to the seat, the weight the system detects may be too low.</p> <div data-bbox="545 543 1690 751" style="border: 1px solid gray; padding: 5px;"> <p data-bbox="554 549 1376 580">▲ WARNING Risk of injury or fatal injury due to a disabled front passenger airbag</p> <p data-bbox="554 590 1681 642">If the front passenger airbag is disabled, the front passenger airbag will not be deployed in the event of an accident and cannot perform its intended protective function.</p> <p data-bbox="554 652 1653 704">A person in the front passenger seat could then, for example, come into contact with the vehicle's interior, especially if the person is sitting too close to the cockpit.</p> <p data-bbox="554 714 1598 740">► Make sure, both before and during the journey, that the status of the front passenger airbag is correct.</p> </div> <ul data-bbox="545 766 1358 865" style="list-style-type: none"> <li data-bbox="545 766 1265 792">► Stop the vehicle immediately in accordance with the traffic conditions. <li data-bbox="545 802 1265 828">► Make sure that no objects are trapped under the front passenger seat. <li data-bbox="545 839 1358 865">► Check the status of the automatic front passenger air bag shutoff (→ page 49).



Display messages	Possible causes/consequences and ► Solutions
<p>Front Passenger Airbag Enabled See Operator's Manual</p>	<p>► If necessary, consult a qualified specialist workshop immediately.</p> <p>* The front passenger air bag and the front passenger knee air bag will be enabled while the vehicle is in motion in the following situations:</p> <ul style="list-style-type: none"> • even when a child, a small adult or an object weighing less than the system weight threshold is located on the front passenger seat • even when the front passenger seat is not occupied <p>The system may detect objects or forces that are adding to the weight applied to the seat.</p> <div style="border: 1px solid black; padding: 5px; margin: 10px 0;"> <p>⚠ WARNING Risk of injury or death when using a child restraint system while the front passenger airbag is enabled</p> <p>If you secure a child in a child restraint system on the front passenger seat and the front passenger airbag is enabled, the front passenger airbag can deploy in the event of an accident. The child could be struck by the airbag.</p> <p>► Ensure, both before and during the journey, that the status of the front passenger airbag is correct.</p> <p>NEVER use a rearward facing child restraint on a seat protected by an ACTIVE AIRBAG in front of it, DEATH or SERIOUS INJURY to the CHILD can occur.</p> </div> <p>► Stop the vehicle immediately in accordance with the traffic conditions.</p> <p>► Make sure that no objects are trapped under the front passenger seat.</p>



Display messages	Possible causes/consequences and ► Solutions
	<ul style="list-style-type: none"> ► Check the status of the automatic front passenger air bag shutoff (→ page 49). ► If necessary, consult a qualified specialist workshop immediately.
Occupant Presence Reminder Inoperative	<ul style="list-style-type: none"> * The occupant presence reminder is malfunctioning ► Consult a qualified specialist workshop.
 <p data-bbox="195 493 436 539">Do Not Leave People or Animals in the Vehicle</p>	<ul style="list-style-type: none"> * The occupant presence reminder suspects that there are persons or animals in the rear passenger compartment of the vehicle. ► Do not leave any persons or animals behind when leaving the vehicle.

SmartKey





Display messages	Possible causes/consequences and ► Solutions
 <p data-bbox="195 786 376 809">Obtain a New Key</p>	<ul style="list-style-type: none"> * Have the SmartKey replaced. ► Consult a qualified specialist workshop.

Display messages	Possible causes/consequences and ► Solutions
 Replace Key Battery	<p>* The SmartKey battery is discharged.</p> <ul style="list-style-type: none">► Replace the battery (→ page 79).
 Key Not Detected (white display message)	<p>* The SmartKey is currently undetected.</p> <ul style="list-style-type: none">► Change the location of the SmartKey in the vehicle.► Try to start the vehicle.► If the SmartKey is still not detected, place it in the marked space for starting with the SmartKey (→ page 184).► Start the vehicle.
 Key Not Detected (red display message)	<p>* The key can no longer be detected during a journey and may no longer be in the vehicle.</p> <p>If the key is no longer in the vehicle and you switch off the vehicle:</p> <ul style="list-style-type: none">• You can no longer start the vehicle.• You cannot centrally lock the vehicle. <ul style="list-style-type: none">► Ensure that the key is in the vehicle. <p>If the key is in the vehicle and is still not detected:</p> <ul style="list-style-type: none">► Stop the vehicle immediately in accordance with the traffic conditions.► Place the key in the slot for starting the engine with the key (→ page 184).



Display messages	Possible causes/consequences and ► Solutions
	<p>The key battery is weak or discharged.</p> <ul style="list-style-type: none"> ► Check the battery using the indicator lamp (→ page 77). ► Replace the key battery, if necessary (→ page 79).
 <p>Initializing Key Please Wait</p>	<ul style="list-style-type: none"> * The vehicle is processing in order to teach in the new SmartKey. <ul style="list-style-type: none"> ► Wait until processing is complete.
 <p>Don't Forget Your Key</p>	<ul style="list-style-type: none"> * A warning tone will also sound. This message reminds you to take your SmartKey with you when you leave the vehicle.
<p>Place the Key in the Marked Space See Operator's Manual</p>	<ul style="list-style-type: none"> * SmartKey detection is malfunctioning. <ul style="list-style-type: none"> ► Change the location of the SmartKey in the vehicle. ► Place the SmartKey in the slot for starting the engine with the SmartKey (→ page 184).
<p>Place SmartKey in Cup Holder or Digital Vehicle Key in Mobile Phone Cradle See Operator's Manual</p>	<ul style="list-style-type: none"> * The SmartKey was not detected. <ul style="list-style-type: none"> ► Place the SmartKey in the marked space (→ page 184). <p>If the SmartKey is still not detected:</p>



Display messages	Possible causes/consequences and ► Solutions
	<ul style="list-style-type: none"> ► Consult a qualified specialist workshop. * The Digital Vehicle Key has not been detected. <ul style="list-style-type: none"> ► Place the Digital Vehicle Key in the marked space (→ page 183). If the Digital Vehicle Key is still not detected: <ul style="list-style-type: none"> ► Consult a qualified specialist workshop.
 <p data-bbox="144 534 325 560">Key Not Detected</p>	<ul style="list-style-type: none"> * The SmartKey or the Digital Vehicle Key is currently undetected. <ul style="list-style-type: none"> ► Change the location of the SmartKey or the Digital Vehicle Key in the vehicle. ► Try to start the vehicle. ► If the SmartKey is still not detected, place the SmartKey in the marked space (→ page 184). ► If the Digital Vehicle Key is still not detected, place the Digital Vehicle Key in the marked space (→ page 183). ► Start the vehicle.
 <p data-bbox="144 747 386 825">Key Not Detected Place Digital Vehicle Key in Mobile Phone Cradle</p>	<ul style="list-style-type: none"> * The SmartKey or the Digital Vehicle Key are no longer detected during a journey and may no longer be in the vehicle. If the SmartKey or the Digital Vehicle Key is no longer in the vehicle and you switch off the vehicle: <ul style="list-style-type: none"> • You can no longer start the vehicle. • You cannot centrally lock the vehicle. ► Ensure that the SmartKey or the Digital Vehicle Key is in the vehicle. <p>If the SmartKey or the Digital Vehicle Key is in the vehicle and is still not detected:</p>

Display messages	Possible causes/consequences and ► Solutions
	<ul style="list-style-type: none"> ► Stop the vehicle immediately in accordance with the traffic conditions. ► Place the SmartKey in the marked space (→ page 184). ► Place the Digital Vehicle Key in the stowage space (→ page 183). <p>The SmartKey battery is weak or discharged.</p> <ul style="list-style-type: none"> ► Check the battery using the indicator lamp (→ page 77). ► Replace the SmartKey battery, if necessary (→ page 79). <p>The condition of charge of the rechargeable battery of the end device with the Digital Vehicle Key is too low.</p> <ul style="list-style-type: none"> ► Immediately charge the rechargeable battery of the Digital Vehicle Key end device. <p>Otherwise, it may not be possible to restart the vehicle after it has been switched off.</p> <p>If the SmartKey or the Digital Vehicle Key is still not detected:</p> <ul style="list-style-type: none"> ► Consult a qualified specialist workshop.
 <p>Replace SmartKey See Operator's Manual</p>	<p>* If the Digital Vehicle Key is not renewed, the vehicle cannot be unlocked/locked or started.</p> <ul style="list-style-type: none"> ► The system automatically renews the Digital Vehicle Key. ► When the renewal is complete, the message disappears and the Digital Vehicle Key is available again.

Display messages	Possible causes/consequences and ► Solutions
 <p>Take SmartKey With You</p>	<ul style="list-style-type: none">* A warning tone will also sound. This message reminds you to take your SmartKey with you when you leave the vehicle. This also applies to the Digital Vehicle Key.
 <p>Digital Vehicle Key Charge Device</p>	<ul style="list-style-type: none">* The condition of charge of the rechargeable battery of the end device with the Digital Vehicle Key is too low.<ul style="list-style-type: none">► Immediately charge the rechargeable battery of the Digital Vehicle Key end device.
 <p>Initializing Key Please Wait</p>	<ul style="list-style-type: none">* The vehicle is processing in order to teach in the new Digital Vehicle Key.<ul style="list-style-type: none">► Wait until processing is complete.
 <p>Key Does Not Belong to Vehicle</p>	<ul style="list-style-type: none">* The vehicle cannot be unlocked/locked or started.<ul style="list-style-type: none">► Use the Digital Vehicle Key belonging to the vehicle.

Lights

Display messages	Possible causes/consequences and ► Solutions
 <p data-bbox="195 381 356 436">Check Left Low Beam (example)</p>	<ul style="list-style-type: none"> <li data-bbox="522 288 1027 313">* The corresponding light source is malfunctioning. <ul style="list-style-type: none"> <li data-bbox="543 322 759 348">► Drive on carefully. <li data-bbox="543 356 1088 382">► Consult a qualified specialist workshop immediately. <li data-bbox="543 390 1689 443">① LED light sources: the display message for the corresponding light appears only when all the light-emitting diodes in the light are faulty.
 <p data-bbox="195 553 436 601">Malfunction See Operator's Manual</p>	<ul style="list-style-type: none"> <li data-bbox="522 459 916 485">* The exterior lighting is malfunctioning. <ul style="list-style-type: none"> <li data-bbox="543 494 966 520">► Consult a qualified specialist workshop.
 <p data-bbox="195 721 445 769">Automatic Driving Lights Inoperative</p>	<ul style="list-style-type: none"> <li data-bbox="522 627 1143 653">* The light sensor for automatic driving lights is malfunctioning. <ul style="list-style-type: none"> <li data-bbox="543 662 966 687">► Consult a qualified specialist workshop.



Display messages	Possible causes/consequences and ► Solutions
 <p data-bbox="144 339 362 365">Switch On Headlights</p>	<ul style="list-style-type: none"> * You are driving without low-beam headlamps. <ul style="list-style-type: none"> ► Turn the light switch to the  or AUTO position.
 <p data-bbox="144 482 319 508">Switch Off Lights</p>	<ul style="list-style-type: none"> * You are leaving the vehicle and the lights are still switched on. <ul style="list-style-type: none"> ► Turn the light switch to the AUTO position.
<p data-bbox="144 531 402 581">DIGITAL LIGHT Functions Limited</p>	<ul style="list-style-type: none"> * The DIGITAL LIGHT system is malfunctioning. The lighting system will continue to work even without the functions of the DIGITAL LIGHT system. <ul style="list-style-type: none"> ► Consult a qualified specialist workshop.
<p data-bbox="144 631 410 708">Adaptive Highbeam Assist Currently Unavailable See Operator's Manual</p>	<ul style="list-style-type: none"> * Adaptive Highbeam Assist is temporarily unavailable. The system limits have been reached (→ page 151). Once the cause of the problem is no longer present, the system will be available again. The Adaptive Highbeam Assist Now Available display message will appear. <ul style="list-style-type: none"> ► Drive on. ► Operate the high beam manually until Adaptive Highbeam Assist is available again.



Display messages	Possible causes/consequences and ► Solutions
<p>Adaptive Highbeam Assist Inoperative</p>	<p>* Adaptive Highbeam Assist is malfunctioning.</p> <ul style="list-style-type: none"> ► Drive on <p>or</p> <ul style="list-style-type: none"> ► Stop the vehicle in accordance with the traffic conditions and restart the vehicle. ► If the display message does not disappear: consult a qualified specialist workshop. ► Until then, operate the high beam manually.
<p>Adaptive Highbeam Assist Plus Currently Unavailable See Operator's Manual</p>	<p>* Adaptive Highbeam Assist Plus is temporarily unavailable. The system limits have been reached (→ page 152). Once the cause of the problem is no longer present, the system will be available again. The Adaptive Highbeam Assist Plus Now Available display message will appear.</p> <ul style="list-style-type: none"> ► Drive on. ► Operate the high beam manually until Adaptive Highbeam Assist Plus is available again.
<p>Adaptive Highbeam Assist Plus Inoperative</p>	<p>* Adaptive Highbeam Assist Plus is malfunctioning.</p> <ul style="list-style-type: none"> ► Drive on. <p>or</p> <ul style="list-style-type: none"> ► Stop the vehicle in accordance with the traffic conditions and restart the vehicle. ► If the display message does not disappear: consult a qualified specialist workshop. ► Until then, operate the high beam manually.

464 Display messages and warning/indicator lamps



Display messages	Possible causes/consequences and ► Solutions
Hazard Warning Light Malfunction	<ul style="list-style-type: none">* The hazard warning lamp switch is malfunctioning.<ul style="list-style-type: none">► Consult a qualified specialist workshop.



Climate control

Display messages	Possible causes/consequences and ► Solutions
 <p>Currently Not Available Charging of the High-voltage Battery Not Completed</p>	<ul style="list-style-type: none">* The high-voltage battery is charging. Pre-entry climate control cannot be switched on.<ul style="list-style-type: none">► Wait until the charging process has achieved a minimum condition of charge.
 <p>Currently Not Available Charge High-voltage Battery</p>	<ul style="list-style-type: none">* The charge of the high-voltage battery is too low. Pre-entry climate control cannot be switched on.<ul style="list-style-type: none">► Charge the high-voltage battery (→ page 200).

Display messages	Possible causes/consequences and ► Solutions
 <p data-bbox="194 341 462 419">Pre-entry Climate Control Available Again via SmartKey after Vehicle Start</p>	<ul style="list-style-type: none"><li data-bbox="526 248 1626 336">* You have attempted to switch on pre-entry climate control more than three times with the vehicle switched off.<ul style="list-style-type: none"><li data-bbox="545 279 1025 336">► Start the vehicle for ten seconds. Pre-entry climate control is operational again.
 <p data-bbox="194 533 471 637">Pre-entry Climate Control via SmartKey Currently Not Available. High-voltage Battery Low</p>	<ul style="list-style-type: none"><li data-bbox="526 440 1589 528">* The charge of the high-voltage battery is too low. Pre-entry climate control cannot be switched on.<ul style="list-style-type: none"><li data-bbox="545 471 1589 528">► Charge the high-voltage battery (→ page 200). When the high-voltage battery is sufficiently charged, pre-entry climate control will be operational again.



Drive system

Display messages	Possible causes/consequences and ► Solutions
 <p data-bbox="144 381 413 433">Towing Not Permitted See Operator's Manual</p>	<p data-bbox="473 291 838 313">* The drive system is malfunctioning.</p> <ul style="list-style-type: none"> <li data-bbox="495 324 1289 347">► Have the vehicle transported only using a transporter or trailer (→ page 400).
 <p data-bbox="144 550 413 601">Acoustic Presence Indicator Inoperative</p>	<p data-bbox="473 459 1628 505">* The sound generator (acoustic vehicle warning system) is malfunctioning. No vehicle noises are being produced. The vehicle may not be heard by other road users.</p> <ul style="list-style-type: none"> <li data-bbox="495 519 783 541">► Drive with particular care. <li data-bbox="495 552 912 574">► Consult a qualified specialist workshop.
<p data-bbox="144 628 413 728">To Switch Off Vehicle Press and Hold Start/Stop Button for at Least 3 Seconds or Press 3 Times</p>	<p data-bbox="473 628 1171 651">* You have pressed the start/stop button while the vehicle is in motion.</p> <ul style="list-style-type: none"> <li data-bbox="495 662 1258 684">► To switch off the drive system while the vehicle is in motion (→ page 183).
<p data-bbox="144 756 402 801">Cannot Start Vehicle See Operator's Manual</p>	<p data-bbox="473 756 851 779">* It is not possible to start the vehicle.</p> <p data-bbox="495 789 959 812">A malfunction has occurred in the drive system.</p> <ul style="list-style-type: none"> <li data-bbox="495 822 851 845">► Switch the vehicle off and lock it.



Display messages	Possible causes/consequences and ► Solutions
	<ul style="list-style-type: none"> ► After waiting for a short time, unlock the vehicle and start it again. ► If the display message appears again and the vehicle does not start, consult a qualified specialist workshop.
<div style="text-align: center;">  </div> <p data-bbox="194 414 452 466">Check Coolant Level See Operator's Manual</p>	<p data-bbox="526 326 813 347">* The coolant level is too low.</p> <div style="border: 1px solid black; padding: 5px; margin: 5px 0;"> <p data-bbox="554 372 1201 398">! NOTE Damage to the drive system due to insufficient coolant</p> <ul style="list-style-type: none"> ► Avoid long journeys with insufficient coolant. </div> <ul style="list-style-type: none"> ► Have the cooling system of the drive system checked at a qualified specialist workshop.
<div style="text-align: center;">  </div> <p data-bbox="194 600 443 652">Coolant Stop Switch Off Vehicle</p>	<p data-bbox="526 507 766 528">* The coolant is too hot.</p> <ul style="list-style-type: none"> ► Stop the vehicle immediately in accordance with the traffic conditions and switch off the drive system. <div style="border: 1px solid black; padding: 5px; margin: 5px 0;"> <p data-bbox="554 600 1099 626">! WARNING Risk of injury due to overheated vehicle</p> <p data-bbox="554 642 1663 688">If you open the hood in the event of an overheated vehicle or fire in the engine compartment, the following situations may occur:</p> <ul style="list-style-type: none"> • You may come into contact with hot gases. • You may come into contact with other escaping hot operating fluids. <ul style="list-style-type: none"> ► In the event of overheating or fire in the engine compartment, keep the hood closed and call the fire service. ► Allow the overheated vehicle to cool down first if you need to open the hood. </div>



Display messages	Possible causes/consequences and ► Solutions
	<ul style="list-style-type: none"> ► Wait until the drive system has cooled down. ► Make sure that the air supply to the vehicle radiator is not obstructed. ► Avoiding high loads on the drive system, drive to the nearest qualified specialist workshop.
	<ul style="list-style-type: none"> * The cooling system has detected a component malfunction. ► Avoiding high loads on the drive system, drive to the nearest qualified specialist workshop.
<p>Socket Flap Blocked Open Manually</p>	<ul style="list-style-type: none"> * The socket flap is not opening automatically. An obstruction may be hindering the opening process. ► Make sure that no objects are in the opening area. ► Open the socket flap again.
<p>Close Socket Flap Manually Anti-Trap Protection Active</p>	<ul style="list-style-type: none"> * The socket flap is not closing automatically. An obstruction may be hindering the closing process. ► Make sure that no objects are in the closing area. ► Close the socket flap again.
<p>Close Socket Flap Manually Automatic Not Functioning</p>	<ul style="list-style-type: none"> * The socket flap is not closing automatically. The motor of the socket flap may be defective. ► Close the socket flap manually. ► Consult a qualified specialist workshop.

Display messages	Possible causes/consequences and ► Solutions
 <p>Charger Cable Connected</p>	<ul style="list-style-type: none"> * You cannot pull away while the charging cable is connected. <ul style="list-style-type: none"> ► Disconnect the charging cable from the vehicle.
<p>Not Possible to Unlock Charging Cable See Operator's Manual</p>	<ul style="list-style-type: none"> * The charging cable connector cannot be removed from the charging station's socket. <ul style="list-style-type: none"> ► Press the EMERGENCY OFF switch on the charging station. <p>If the charging cable connector cannot be removed after that:</p> <ul style="list-style-type: none"> ► Request service personnel from the operator of the charging station via the emergency call button or the emergency numbers attached to the charging station.
<p>Vehicle Currently Not Charging... Charging Station Fault</p>	<ul style="list-style-type: none"> * A malfunction has occurred in the charging station or the RFID card is not recognized. <ul style="list-style-type: none"> ► Start the charging process at a different charging station. or ► Have the RFID card checked to ensure it is functioning.
<p>Charging Fault Change Charging Mode See Operator's Manual</p>	<ul style="list-style-type: none"> * A temporary malfunction has occurred in the charging station. <ul style="list-style-type: none"> ► Wait until the malfunction has passed. or ► Start the charging process at a different charging station.

Display messages	Possible causes/consequences and ► Solutions
AC Charging Inoperative Service Required	<ul style="list-style-type: none"> * The charging process cannot be started due to a malfunction. <ul style="list-style-type: none"> ► Consult a qualified specialist workshop.
DC Charging Inoperative Service Required	<ul style="list-style-type: none"> * The charging process cannot be started due to a malfunction. <ul style="list-style-type: none"> ► Consult a qualified specialist workshop.
Reduced Drive System Performance See Operator's Manual	<ul style="list-style-type: none"> * The drive system is outside the normal operating temperature range, e.g. due to extremely low or high outside temperatures. Drive system power output is reduced. The yellow  reduced-power warning lamp is on. Once the operating temperature of the drive system returns to normal (e.g. after a short trip), the full output will be available again. The display message and the yellow  reduced-power warning lamp will go out. <ul style="list-style-type: none"> ► Drive on carefully. * The high-voltage battery is not charged sufficiently. Drive system power output is reduced. The yellow  reduced-power warning lamp is on. <ul style="list-style-type: none"> ► Drive on carefully. ► Charge the high-voltage battery immediately. * If the drive system power output is still reduced, there is a malfunction in the drive system. <ul style="list-style-type: none"> ► Drive on carefully. ► Consult a qualified specialist workshop.





Display messages	Possible causes/consequences and ► Solutions
<p>Charge High-Voltage Battery Vehicle Starting Ability Otherwise Not Guaranteed</p>	<ul style="list-style-type: none"> * Due to a possible decrease in the temperature of the high-voltage battery, the starting ability or the range may decrease significantly until the vehicle is restarted. <ul style="list-style-type: none"> ► Charge the high-voltage battery (→ page 200).
<p>Wait in READY State Battery Is Warming Up See Operator's Manual</p>	<ul style="list-style-type: none"> * Operational readiness is established READY and the transmission position P is engaged. The high-voltage battery is warmed up to the operating temperature. This process can take a few minutes and may be prolonged if defrosting of the windshield MAX is activated. The heating process ends when transmission position D is engaged. However, when driving, the output is significantly limited until the high-voltage battery has reached its operating temperature.
<p>Preparing Drive System...</p>	<ul style="list-style-type: none"> * The insulation of the drive system is being tested. This process can last for up to ten seconds.
<div style="text-align: center;">  </div> <p>Battery Too Low Stop Vehicle Charge Immediately</p>	<ul style="list-style-type: none"> * The condition of charge of the high-voltage battery is so low that it is no longer possible to drive the vehicle. The drive system can no longer be restarted. When the drive system is restarted, the message Battery Too Low Stop Vehicle Charge Immediately will appear again. <ul style="list-style-type: none"> ► Stop the vehicle immediately in accordance with the traffic conditions. ► Charge the high-voltage battery (→ page 200).

Display messages	Possible causes/consequences and ► Solutions
 <p data-bbox="144 342 402 418">Battery Overheated Stop! Everyone Get Out! Out- doors if Possible</p>	<ul style="list-style-type: none"> <li data-bbox="473 249 1101 273">* The high-voltage battery has overheated. There is a risk of fire. <ul style="list-style-type: none"> <li data-bbox="495 283 1215 307">► Stop the vehicle immediately in accordance with the traffic conditions. <li data-bbox="495 318 1387 341">► If possible, stop the vehicle in the open air and ensure that all vehicle occupants get out. <li data-bbox="495 352 1600 384">◉ Supporting vehicle functions may activate automatically, e.g. air-recirculation mode as part of climate control. <li data-bbox="495 394 765 418">► Do not continue driving. <li data-bbox="495 428 1300 452">► If smoke is present, leave the danger zone and call the fire service immediately. <li data-bbox="495 463 1332 486">► Consult a qualified specialist workshop even if there are no external signs of a fire.
 <p data-bbox="144 598 266 622">Malfunction</p>	<ul style="list-style-type: none"> <li data-bbox="473 505 1143 529">* The drive system is malfunctioning. A warning tone will also sound. <ul style="list-style-type: none"> <li data-bbox="495 539 912 563">► Consult a qualified specialist workshop.
 <p data-bbox="144 739 347 788">Malfunction Service Required</p>	<ul style="list-style-type: none"> <li data-bbox="473 646 833 670">* The drive system is malfunctioning. <ul style="list-style-type: none"> <li data-bbox="495 680 912 704">► Consult a qualified specialist workshop.

Display messages	Possible causes/consequences and ► Solutions
 <p data-bbox="194 341 462 419">Have High-Voltage System Checked See Operator's Manual</p>	<ul style="list-style-type: none"> * A function restriction has occurred in the drive system. <ul style="list-style-type: none"> ► Consult a qualified specialist workshop.
<p data-bbox="194 440 425 492">Do Not Restart Vehicle Service Required</p>	<ul style="list-style-type: none"> * It is not possible to restart the drive system due to a malfunction. <ul style="list-style-type: none"> ► Do not switch off the drive system; drive on to the nearest qualified specialist workshop.
 <p data-bbox="194 606 443 683">Drive Power and Range Reduced See Operator's Manual</p>	<ul style="list-style-type: none"> * A malfunction has occurred in the high-voltage battery. Output and range will be severely restricted. <ul style="list-style-type: none"> ► Switch the vehicle off and lock it. ► After waiting for a short time, unlock the vehicle and start it again. <p data-bbox="545 668 914 694">If the display message appears again:</p> <ul style="list-style-type: none"> ► Drive on carefully. ► Fully charge the high-voltage battery (→ page 200). <p data-bbox="545 787 1349 813">If the output and range are still reduced, there is a malfunction in the drive system.</p> <ul style="list-style-type: none"> ► Drive on carefully. ► Consult a qualified specialist workshop.

474 Display messages and warning/indicator lamps

Display messages	Possible causes/consequences and ► Solutions
Cannot Start Vehicle See Operator's Manual	<ul style="list-style-type: none">* It is not possible to start the vehicle. A malfunction has occurred in the drive system.<ul style="list-style-type: none">► Switch the vehicle off and lock it.► After waiting for a short time, unlock the vehicle and start it again.► If the display message appears again and the vehicle does not start, consult a qualified specialist workshop.
Drive Malfunction Achievable Speed Limited Stop Soon	<ul style="list-style-type: none">* The drive system is malfunctioning. The maximum vehicle speed is restricted. The drive system will shut off within a few kilometers.<ul style="list-style-type: none">► Stop the vehicle immediately in accordance with the traffic conditions and switch off the drive system. Do not continue driving.► Do not tow the vehicle; stop towing if necessary.► Consult a qualified specialist workshop.
Drive Malfunction Achievable Speed Severely Limited See Operator's Manual	<ul style="list-style-type: none">* The drive system is malfunctioning. The maximum vehicle speed is restricted.<ul style="list-style-type: none">► Consult a qualified specialist workshop.

Display messages	Possible causes/consequences and ► Solutions
 <p data-bbox="194 341 471 393">Reserve Level Charge High-Voltage Battery</p>	<ul style="list-style-type: none"> * The condition of charge of the high-voltage battery has dropped into the reserve range. <ul style="list-style-type: none"> ► Charge the high-voltage battery (→ page 200).
 <p data-bbox="194 507 323 533">Malfunction</p>	<ul style="list-style-type: none"> * The drive system is malfunctioning. The output of your vehicle is restricted. <ul style="list-style-type: none"> ► Consult a qualified specialist workshop.
 <p data-bbox="194 647 434 673">Stop Switch Off Vehicle</p>	<ul style="list-style-type: none"> * The drive system is malfunctioning. <ul style="list-style-type: none"> ► Stop the vehicle immediately in accordance with the traffic conditions and switch off the drive system. Do not continue driving. ► Do not tow the vehicle; stop towing if necessary. ► Consult a qualified specialist workshop.
 <p data-bbox="194 818 397 870">Malfunction Service Required</p>	<ul style="list-style-type: none"> * The drive system is malfunctioning. <ul style="list-style-type: none"> ► Visit a qualified specialist workshop.



Display messages	Possible causes/consequences and ► Solutions
 <p data-bbox="144 339 380 389">Performance Extremely Limited</p>	<p data-bbox="473 249 1031 275">* A malfunction has occurred in the high-voltage battery. Output and range will be severely restricted.</p> <ul style="list-style-type: none"> <li data-bbox="495 319 851 344">► Switch the vehicle off and lock it. <li data-bbox="495 353 1175 379">► After waiting for a short time, unlock the vehicle and start it again. <p data-bbox="495 405 861 430">If the display message appears again:</p> <ul style="list-style-type: none"> <li data-bbox="495 439 704 465">► Drive on carefully. <li data-bbox="495 473 1036 499">► Fully charge the high-voltage battery (→ page 200). <p data-bbox="495 525 1300 551">If the output and range are still reduced, there is a malfunction in the drive system.</p> <ul style="list-style-type: none"> <li data-bbox="495 559 704 585">► Drive on carefully. <li data-bbox="495 593 916 619">► Consult a qualified specialist workshop.
<p data-bbox="144 632 417 736">High-Voltage Battery Fault No Start in Approx. XXX mi Service Required (yellow display message)</p>	<p data-bbox="473 632 1031 658">* A malfunction has occurred in the high-voltage battery. It will no longer be possible to start the electric drive system after the distance displayed has been covered.</p> <ul style="list-style-type: none"> <li data-bbox="495 702 1622 728">► Have the necessary maintenance work on the high-voltage battery carried out at a qualified specialist workshop.
<p data-bbox="144 760 417 864">High-Voltage Battery Fault No Start in Approx. XXX mi Service Required (red display message)</p>	<p data-bbox="473 760 1031 786">* A malfunction has occurred in the high-voltage battery. It will no longer be possible to start the electric drive system after the distance displayed has been covered.</p> <ul style="list-style-type: none"> <li data-bbox="495 829 1641 882">► Have the necessary maintenance work on the high-voltage battery carried out immediately at a qualified specialist workshop.



Display messages	Possible causes/consequences and ► Solutions
<p>High-Voltage Battery Fault Do Not Restart Service Required</p>	<ul style="list-style-type: none"> * A malfunction has occurred in the high-voltage battery. It will no longer be possible to restart the drive system once it has been switched off. <ul style="list-style-type: none"> ► Do not switch off the drive system; drive on to the nearest qualified specialist workshop.

Vehicle



Display messages	Possible causes/consequences and ► Solutions
	<ul style="list-style-type: none"> * The driver's display is inoperative due to a failed software update. The display message will be shown every time the engine is started. <div style="background-color: #f0f0f0; padding: 5px; margin: 10px 0;"> <p>⚠ WARNING Risk of accident due to failure of the driver display</p> <p>In the event that the driver display fails or malfunctions, you will not recognize function restrictions affecting systems relevant to safety. This may impair operating safety.</p> <ul style="list-style-type: none"> ► Park the vehicle safely as soon as possible and notify a qualified specialist workshop. </div> <p>If the driver's display fails, you may not recognize function restrictions affecting systems relevant to safety or the speed display, for example. The operating safety of the vehicle may be impaired (→ page 332).</p> <ul style="list-style-type: none"> ► Have the vehicle checked by a qualified specialist workshop immediately.



Display messages	Possible causes/consequences and ► Solutions
 <p data-bbox="144 342 389 443">Vehicle Ready to Drive Shutdown Occurs When Locked or After a Few Minutes</p>	<p data-bbox="473 249 996 272">* You are leaving the vehicle in a ready-to-drive state.</p> <ul style="list-style-type: none"> <li data-bbox="495 283 1289 306">► Get out of the vehicle, secure it against rolling away and take the key with you. <li data-bbox="495 318 1637 368">► If you do not leave the vehicle, switch off the electrical consumers, e.g. the seat heating. Otherwise, the 12-V battery may discharge and starting the engine may be possible only with the help of a second battery (jump start).
<p data-bbox="144 469 413 520">Restricted Mode Activated Drive Power Reduced</p>	<p data-bbox="473 469 1337 492">* When the beginner driver mode is activated, the drive power is reduced (→ page 232).</p>
<p data-bbox="144 545 421 620">Head-up Display Currently Unavailable See Operator's Manual</p>	<p data-bbox="473 545 1151 568">* The head-up display is temporarily unavailable. Possible causes are:</p> <ul style="list-style-type: none"> <li data-bbox="500 580 851 602">• malfunctions in the power supply <li data-bbox="500 614 713 637">• signal interference <ul style="list-style-type: none"> <li data-bbox="495 653 1363 676">► Stop in accordance with the traffic conditions and switch the vehicle off and on again. <li data-bbox="495 687 1262 710">► If the display message still appears, consult a qualified specialist workshop.
<p data-bbox="144 732 402 783">Head-up Display Inoperative</p>	<p data-bbox="473 732 898 755">* The head-up display has an internal error.</p> <ul style="list-style-type: none"> <li data-bbox="495 766 916 789">► Consult a qualified specialist workshop.

Display messages	Possible causes/consequences and ► Solutions
<p>Head-up Display Brightness Currently Reduced See Operator's Manual</p>	<p>* The brightness of the head-up display is reduced. Possible causes:</p> <ul style="list-style-type: none"> • Dirt on the windshield in the camera's field of vision • Faulty exterior brightness signals <p>► Switch on the windshield wipers.</p> <p>► Clean the windshield if necessary.</p> <p>► Switch the vehicle off and switch it back on</p> <p>► If the display message still appears, consult a qualified specialist workshop.</p>
 <p>Steering Malfunction Drive Carefully Service Required</p>	<p>* A power steering malfunction has occurred. Steering characteristics may be impaired as a result.</p> <p>► Drive on carefully.</p> <p>► Consult a qualified specialist workshop.</p>
 <p>Steering Malfunction Increased Physical Effort See Operator's Manual</p>	<p>* The power steering assistance is malfunctioning.</p> <div style="background-color: #f0f0f0; padding: 5px; border: 1px solid #ccc;"> <p>⚠ WARNING Risk of an accident due to altered steering characteristics</p> <p>If the power assistance of the steering fails partially or completely, you will need to use more force to steer.</p> <ul style="list-style-type: none"> ► If safe steering is possible, drive on carefully. ► Visit or consult a qualified specialist workshop immediately. </div>

Display messages	Possible causes/consequences and ► Solutions
 <p data-bbox="144 342 410 417">Steering Malfunction Stop Immediately See Operator's Manual</p>	<p data-bbox="473 249 1221 275">* The steering is malfunctioning. Steering capability is significantly impaired.</p> <div data-bbox="500 291 1646 469" style="border: 1px solid black; padding: 5px;"> <p data-bbox="506 298 1132 324">▲ WARNING Risk of accident if steering capability is impaired</p> <p data-bbox="506 339 1387 365">If the steering does not function as intended, the vehicle's operating safety is jeopardized.</p> <ul style="list-style-type: none"> <li data-bbox="506 373 1591 425">► Pull over and stop the vehicle safely as soon as possible, paying attention to road and traffic conditions. Do not continue driving under any circumstances. <li data-bbox="506 436 935 462">► Consult a qualified specialist workshop. </div>
 <p data-bbox="144 578 384 629">Rear Axle Steering Currently Malfunctioning</p>	<p data-bbox="473 484 1336 510">* The rear axle steering is temporarily unavailable. The turning circle may become wider.</p> <ul style="list-style-type: none"> <li data-bbox="491 521 1317 547">► Stop the vehicle in accordance with the traffic conditions and restart the vehicle. <p data-bbox="491 572 911 598">If the display message does not disappear:</p> <ul style="list-style-type: none"> <li data-bbox="491 609 707 635">► Drive on carefully. <li data-bbox="491 645 916 671">► Consult a qualified specialist workshop.
 <p data-bbox="144 772 426 824">Rear Axle Steering Malfunction Service Required</p>	<p data-bbox="473 679 883 705">* The rear axle steering is malfunctioning.</p> <p data-bbox="491 715 883 741">The rear axle has no steering capability.</p> <p data-bbox="491 752 1188 778">The steering wheel may be at an angle when you drive in a straight line.</p> <ul style="list-style-type: none"> <li data-bbox="491 788 924 814">► Adapt your speed and drive on carefully. <li data-bbox="491 824 1036 850">► Consult a qualified specialist workshop immediately.

Display messages	Possible causes/consequences and ► Solutions
 <p data-bbox="194 341 480 393">Rear Axle Steering Malfunction Stop Immediately</p>	<p data-bbox="526 248 1672 404">* The rear axle steering is malfunctioning. The rear axle has no steering capability. The steering wheel may be tilted considerably when you drive in a straight line. Depending on the steering wheel's tilted position, the steering wheel will also vibrate and a continuous warning tone will sound.</p> <div data-bbox="545 419 1690 595" style="border: 1px solid gray; padding: 5px;"> <p data-bbox="554 429 1182 455">⚠ WARNING Risk of accident if steering capability is impaired</p> <p data-bbox="554 466 1441 492">If the steering does not function as intended, the vehicle's operating safety is jeopardized.</p> <ul style="list-style-type: none"> <li data-bbox="554 502 1644 554">► Pull over and stop the vehicle safely as soon as possible, paying attention to road and traffic conditions. Do not continue driving under any circumstances. <li data-bbox="554 564 988 590">► Consult a qualified specialist workshop. </div> <p data-bbox="545 616 1127 642">► When stopping, bear the enlarged vehicle width in mind.</p>
<p data-bbox="194 657 443 709">Snow Chain Mode Maximum Speed Exceeded</p>	<p data-bbox="526 657 1275 683">* The maximum permissible speed for snow chain mode has been exceeded.</p> <p data-bbox="545 688 766 714">► Drive more slowly.</p>
<p data-bbox="194 730 462 782">Ambient Lighting Warning Support Inoperative</p>	<p data-bbox="526 730 1173 756">* The ambient lighting may not provide full visual warning support.</p> <ul style="list-style-type: none"> <li data-bbox="545 761 1136 787">► Lock the vehicle and unlock it again after a few minutes. <li data-bbox="545 792 1367 823">► If the display message appears regularly, contact a qualified specialist workshop.

Display messages	Possible causes/consequences and ► Solutions
	<ul style="list-style-type: none"> * At least one door is open. <ul style="list-style-type: none"> ► Close all doors.
	<ul style="list-style-type: none"> * The hood is open. <div style="border: 1px solid gray; padding: 5px; margin-top: 10px;"> <p>⚠ WARNING Risk of accident due to driving with the hood unlocked</p> <p>The hood may open and block your view.</p> <ul style="list-style-type: none"> ► Never release the hood when driving. ► Before every trip, ensure that the hood is locked. </div> <ul style="list-style-type: none"> ► Stop the vehicle immediately in accordance with the traffic conditions. ► Do not continue driving. ► Consult a qualified specialist workshop.
	<ul style="list-style-type: none"> * The tailgate is open. <ul style="list-style-type: none"> ► Close the tailgate.

Display messages	Possible causes/consequences and ► Solutions
 <p data-bbox="195 342 371 363">Add Washer Fluid</p>	<ul style="list-style-type: none"> * The washer fluid level in the washer fluid reservoir has dropped below the minimum. <ul style="list-style-type: none"> ► Add washer fluid (→ page 381).
 <p data-bbox="195 484 445 505">Washing Fluid Flap Open</p>	<ul style="list-style-type: none"> * The washer fluid filler flap is open. <ul style="list-style-type: none"> ► Close washer fluid filler flap (→ page 381).
<p data-bbox="195 533 463 581">Windshield Wiper Malfunction</p>	<ul style="list-style-type: none"> * The windshield wiper is malfunctioning. <ul style="list-style-type: none"> ► Restart the vehicle. If the display message still appears: <ul style="list-style-type: none"> ► Consult a qualified specialist workshop.

Transmission

Display messages	Possible causes/consequences and ► Solutions
<p data-bbox="195 817 463 865">Shift to P Only When Vehicle Is Stationary</p>	<ul style="list-style-type: none"> * It is possible to select the park position P only if the vehicle is stationary. <ul style="list-style-type: none"> ► Depress the brake pedal to stop.





Display messages	Possible causes/consequences and ► Solutions
Depress Brake to Shift from P	<ul style="list-style-type: none"> ► Shift the transmission to park position P when the vehicle is stationary. <p>* You have attempted to shift the transmission out of park position P and into another transmission position.</p> <ul style="list-style-type: none"> ► Depress the brake pedal. ► Select transmission position D, R or neutral N.
To Deselect P or N Depress Brake and Start Vehicle	<p>* You have attempted to shift the transmission out of park position P or neutral N and into another transmission position.</p> <ul style="list-style-type: none"> ► Depress the brake pedal. ► Start the vehicle. ► Change the transmission position.
Depress Brake to Shift to D or R	<p>* You have attempted to select transmission position D or R.</p> <ul style="list-style-type: none"> ► Depress the brake pedal. ► Select transmission position D or R.
Depress Brake to Shift to R	<p>* You have attempted to select transmission position R.</p> <ul style="list-style-type: none"> ► Depress the brake pedal. ► Select transmission position R.
Service Required Apply Parking Brake to Park	<p>* A malfunction has occurred in the emergency power supply to park position P.</p> <ul style="list-style-type: none"> ► Consult a qualified specialist workshop.









Display messages	Possible causes/consequences and ► Solutions
	<ul style="list-style-type: none"> ► Until then, always select park position P manually before you switch off the vehicle. ► Before leaving the vehicle, apply the electric parking brake.
Risk of Vehicle Rolling Away Driver's Door Open Position P Not Selected	<ul style="list-style-type: none"> * The driver's door is not fully closed and transmission position D, R or neutral N is selected. The vehicle may roll away. <ul style="list-style-type: none"> ► Select park position P when switching off the vehicle.
Risk of Vehicle Rolling Away Apply Parking Brake When Parking	<ul style="list-style-type: none"> * The transmission is malfunctioning. Park position P cannot be selected. <ul style="list-style-type: none"> ► Park the vehicle safely. ► Use the electric parking brake to secure the vehicle against rolling away. ► On gradients, turn the front wheels so that the vehicle will roll towards the curb if it starts moving.
Risk of Vehicle Rolling Away N Activated Manually No Automatic Change to P	<ul style="list-style-type: none"> * While the vehicle was at a standstill or driving at very low speed, neutral N was engaged with the drive system or the vehicle switched on. <div style="border: 1px solid black; padding: 5px; margin-top: 10px;"> <p>! NOTE Damage to the vehicle due to rolling away</p> <p>When the vehicle is switched off or the driver's door is opened, automatic engagement of park position P is deactivated. The vehicle may roll away.</p> <ul style="list-style-type: none"> ► Be ready to brake. ► Do not leave the vehicle unattended. </div>

Display messages	Possible causes/consequences and ► Solutions
	<ul style="list-style-type: none"> ► Depress the brake pedal until the vehicle comes to a standstill. ► Engage park position P when the vehicle is stationary with the brake pedal depressed. ► To continue driving with the brake pedal depressed, select transmission position D or R.
N Automatically Activated Please Shift to Transmission Position Again	<ul style="list-style-type: none"> * Neutral N was automatically engaged when the vehicle was rolling or being driven. ⓘ When you open the driver's door in neutral N, park position P will be engaged automatically. ► Engage park position P when the vehicle is stationary with the brake pedal depressed. ► To continue driving with the brake pedal depressed, select transmission position D or R.
N is Engaged Shift to Desired Gear	<ul style="list-style-type: none"> * The accelerator pedal was depressed while the vehicle was rolling or moving in neutral N. ► To accelerate the vehicle, select transmission position D or R.
Reversing Not Possible Service Required	<ul style="list-style-type: none"> * The transmission is malfunctioning. It is not possible to select transmission position R. ► Consult a qualified specialist workshop.
Transmission Malfunction Stop	<ul style="list-style-type: none"> * The transmission is malfunctioning. The transmission shifts to neutral N automatically. ► Stop the vehicle immediately in accordance with the traffic conditions. ► Depress the brake pedal. ► Engage park position P. ► Consult a qualified specialist workshop.

Display messages	Possible causes/consequences and ► Solutions
Service Required Do Not Change Transmission Position	<ul style="list-style-type: none">* The transmission is malfunctioning. It is no longer possible to change the transmission position.<ul style="list-style-type: none">► If transmission position D is selected, consult a qualified specialist workshop and do not change the transmission position.► For all other transmission positions, park the vehicle safely.► Consult a qualified specialist workshop or breakdown service.
Auxiliary Battery Malfunction (white display message)	<ul style="list-style-type: none">* There is a malfunction in the auxiliary battery.<ul style="list-style-type: none">► Consult a qualified specialist workshop.► Until then, always select park position P manually before you switch off the vehicle.► Before leaving the vehicle, apply the electric parking brake.

Brakes

Display messages	Possible causes/consequences and ► Solutions
<div data-bbox="155 291 310 373" data-label="Image"> </div> <p data-bbox="155 381 255 407">(USA only)</p> <div data-bbox="155 418 310 501" data-label="Image"> </div> <p data-bbox="155 508 284 534">(Canada only)</p> <p data-bbox="144 541 406 591">Parking Brake See Operator's Manual</p>	<p data-bbox="476 288 1289 313">* The yellow  indicator lamp is lit. The electric parking brake is malfunctioning.</p> <p data-bbox="495 324 583 350">To apply:</p> <ul data-bbox="495 357 1086 417" style="list-style-type: none"> <li data-bbox="495 357 957 383">► Switch the vehicle off and switch it back on. <li data-bbox="495 390 1086 417">► Apply the electric parking brake manually (→ page 222). <p data-bbox="495 443 1018 469">If it is not possible to apply the electric parking brake:</p> <ul data-bbox="495 476 1206 536" style="list-style-type: none"> <li data-bbox="495 476 916 502">► Consult a qualified specialist workshop. <li data-bbox="495 509 1206 536">► Where necessary, also secure the parked vehicle against rolling away. <p data-bbox="476 543 1641 593">* The yellow  indicator lamp and the red  (USA only) or  (Canada only) indicator lamp are lit. The electric parking brake is malfunctioning.</p> <p data-bbox="495 609 602 635">To release:</p> <ul data-bbox="495 642 1108 702" style="list-style-type: none"> <li data-bbox="495 642 957 668">► Switch the vehicle off and switch it back on. <li data-bbox="495 675 1108 702">► Release the electric parking brake manually (→ page 222). <p data-bbox="495 709 519 735">or</p> <ul data-bbox="495 742 1151 768" style="list-style-type: none"> <li data-bbox="495 742 1151 768">► Release the electric parking brake automatically (→ page 222). <p data-bbox="495 775 1077 801">If it is still not possible to release the electric parking brake:</p> <ul data-bbox="495 809 1156 835" style="list-style-type: none"> <li data-bbox="495 809 1156 835">► Do not continue driving. Consult a qualified specialist workshop.

Display messages	Possible causes/consequences and ► Solutions
	<p>* The yellow  indicator lamp is lit and the red  (USA only) or  (Canada only) indicator lamp is flashing. The electric parking brake is malfunctioning.</p> <p>The electric parking brake could not be applied or released.</p> <ul style="list-style-type: none">► Switch the vehicle off and switch it back on. <p>To apply:</p> <ul style="list-style-type: none">► Release and then apply the electric parking brake manually (→ page 222). <p>To release:</p> <ul style="list-style-type: none">► Apply and then release the electric parking brake manually. <p>If the electric parking brake cannot be applied or the red  (USA only) or  (Canada only) indicator lamp continues to flash:</p> <ul style="list-style-type: none">► Do not continue driving. Consult a qualified specialist workshop.► Where necessary, also secure the parked vehicle against rolling away. <p>* The yellow  indicator lamp is lit and the red  (USA only) or  (Canada only) indicator lamp flashes for approximately ten seconds after the electric parking brake has been applied or released. It then remains lit or goes out. The electric parking brake is malfunctioning.</p> <p>If the state of charge is too low:</p> <ul style="list-style-type: none">► Charge the 12 V battery.

Display messages	Possible causes/consequences and ► Solutions
	<p>To apply:</p> <ul style="list-style-type: none">► Apply the electric parking brake manually. <p>If it is not possible to apply the electric parking brake:</p> <ul style="list-style-type: none">► Consult a qualified specialist workshop.► Where necessary, also secure the parked vehicle against rolling away. <p>To release:</p> <ul style="list-style-type: none">► If the conditions for automatic release are fulfilled and the electric parking brake is not released automatically, release the electric parking brake manually (→ page 222). <p>If it is still not possible to release the electric parking brake:</p> <ul style="list-style-type: none">► Do not continue driving. Consult a qualified specialist workshop.

Display messages	Possible causes/consequences and ► Solutions
<div data-bbox="203 253 360 331"></div> <div data-bbox="203 341 304 367">(USA only)</div> <div data-bbox="203 378 360 455"></div> <div data-bbox="203 466 341 492">(Canada only)</div> <div data-bbox="194 502 425 528">Release Parking Brake</div>	<p>* The red (USA only) or (Canada only) indicator lamp is flashing. The electric parking brake is applied while you are driving:</p> <ul style="list-style-type: none"> • A condition for automatic release of the electric parking brake has not been fulfilled (→ page 222). • You are performing emergency braking using the electric parking brake (→ page 223). <p>► Check the conditions for automatic release of the electric parking brake.</p> <p>► Release the electric parking brake manually.</p>
<div data-bbox="203 554 360 631"></div> <div data-bbox="203 642 304 668">(USA only)</div> <div data-bbox="203 678 360 756"></div> <div data-bbox="203 766 341 792">(Canada only)</div> <div data-bbox="194 802 462 854">Switch on Vehicle to Release the Parking Brake</div>	<p>* The red (USA only) or (Canada only) indicator lamp is lit. You have attempted to release the electric parking brake with the vehicle switched off.</p> <p>► Switch on the vehicle.</p>

Display messages	Possible causes/consequences and ► Solutions
<div data-bbox="155 252 312 332" data-label="Image"> </div> <p data-bbox="145 342 247 366">(USA only)</p> <div data-bbox="155 379 312 458" data-label="Image"> </div> <p data-bbox="145 469 279 493">(Canada only)</p> <p data-bbox="145 503 334 527">Brake Immediately</p>	<p data-bbox="473 249 1153 273">* A malfunction has occurred while the HOLD function was activated.</p> <p data-bbox="491 283 912 307">A horn may also sound at regular intervals.</p> <p data-bbox="491 318 848 341">You cannot start the vehicle system.</p> <ul data-bbox="491 352 1319 404" style="list-style-type: none"> <li data-bbox="491 352 1319 376">► Immediately depress the brake pedal firmly until the display message disappears. <li data-bbox="491 376 944 404">► You cannot start the vehicle system again.
<div data-bbox="155 558 312 638" data-label="Image"> </div> <p data-bbox="145 648 247 672">(USA only)</p> <div data-bbox="155 684 312 764" data-label="Image"> </div> <p data-bbox="145 774 279 798">(Canada only)</p> <p data-bbox="145 809 384 853">Malfunction See Operator's Manual</p>	<p data-bbox="473 556 944 580">* The brake force boosting function is impaired.</p> <p data-bbox="491 590 820 614">Hill Start Assist may be impaired.</p> <div data-bbox="491 624 1652 781" data-label="Complex-Block"> <p data-bbox="506 638 1190 662">▲ WARNING Risk of an accident due to a brake system malfunction</p> <p data-bbox="506 676 1276 700">If the brake system is malfunctioning, braking characteristics may be impaired.</p> <ul data-bbox="506 710 1319 770" style="list-style-type: none"> <li data-bbox="506 710 722 734">► Drive on carefully. <li data-bbox="506 744 1319 770">► Have the brake system checked immediately at a qualified specialist workshop. </div>



Display messages	Possible causes/consequences and ► Solutions
<div data-bbox="205 249 362 332" data-label="Image"> </div> <div data-bbox="192 339 301 366" data-label="Text"> <p>(USA only)</p> </div> <div data-bbox="205 377 362 459" data-label="Image"> </div> <div data-bbox="192 467 332 494" data-label="Text"> <p>(Canada only)</p> </div> <div data-bbox="192 499 369 526" data-label="Text"> <p>Malfunction Stop</p> </div>	<p>* The brake force boosting function is impaired and the braking characteristics may be affected.</p> <div data-bbox="550 291 1696 329" data-label="Text"> <p>▲ WARNING Risk of accident and injury if brake force boosting is malfunctioning</p> </div> <div data-bbox="559 337 1659 391" data-label="Text"> <p>If brake force boosting is malfunctioning, increased brake pedal force may be necessary for braking. The braking characteristics may be impaired. The braking distance can increase in emergency braking situations.</p> </div> <div data-bbox="559 399 1184 459" data-label="List-Group"> <ul style="list-style-type: none"> ► Stop in a safe location immediately. Do not continue driving. ► Consult a qualified specialist workshop. </div>
<div data-bbox="205 556 362 639" data-label="Image"> </div> <div data-bbox="192 646 301 673" data-label="Text"> <p>(USA only)</p> </div> <div data-bbox="205 683 362 766" data-label="Image"> </div> <div data-bbox="192 773 332 800" data-label="Text"> <p>(Canada only)</p> </div> <div data-bbox="192 806 437 832" data-label="Text"> <p>Check Brake Fluid Level</p> </div>	<p>* There is insufficient brake fluid in the brake fluid reservoir.</p> <div data-bbox="550 597 1696 636" data-label="Text"> <p>▲ WARNING Risk of an accident due to low brake fluid level</p> </div> <div data-bbox="559 644 1535 671" data-label="Text"> <p>If the brake fluid level is too low, the braking effect and the braking characteristics may be impaired.</p> </div> <div data-bbox="559 679 1641 797" data-label="List-Group"> <ul style="list-style-type: none"> ► Pull over and stop the vehicle safely as soon as possible, paying attention to road and traffic conditions. Do not continue driving under any circumstances. ► Consult a qualified specialist workshop. ► Do not add brake fluid. </div>

494 Display messages and warning/indicator lamps



Display messages	Possible causes/consequences and ► Solutions
Check Brake Pads See Operator's Manual	<ul style="list-style-type: none">* The brakepads have reached the wear limit.<ul style="list-style-type: none">► Consult a qualified specialist workshop.

Driving and driving safety systems



Display messages	Possible causes/consequences and ► Solutions
 <p data-bbox="144 626 408 678">Currently Unavailable See Operator's Manual</p>	<ul style="list-style-type: none">* ABS and ESP[®] are temporarily unavailable. Other driving systems and driving safety systems (e.g. BAS) may also be temporarily unavailable. The brake system will continue to operate normally. Braking distance may increase in an emergency braking situation. <div data-bbox="495 563 1646 831" style="border: 1px solid black; padding: 5px;"><p>▲ WARNING Risk of skidding if ABS and ESP[®] are malfunctioning</p><p>The wheels may lock during braking and ESP[®] does not perform any vehicle stabilization. The steerability and braking characteristics are heavily impaired and the braking distance may increase. In addition, other driving safety systems are switched off.</p><ul style="list-style-type: none">► Drive carefully on a suitable stretch of road, making slight steering movements at a speed above 19 mph (30 km/h).► If the display message does not disappear, consult a qualified specialist workshop immediately. Drive carefully.</div>

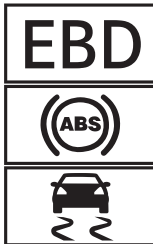

Display messages	Possible causes/consequences and ► Solutions
 <p data-bbox="195 425 469 474">Inoperative See Operator's Manual</p>	<p data-bbox="524 249 1692 346">* ABS and ESP[®] are malfunctioning. Other driving systems and driving safety systems (e.g. BAS) may also be malfunctioning. The brake system will continue to operate normally. Braking distance may increase in an emergency braking situation.</p> <div data-bbox="550 363 1692 578" style="border: 1px solid black; padding: 5px;"> <p data-bbox="559 370 1219 399">▲ WARNING Risk of skidding if ABS and ESP[®] are malfunctioning</p> <p data-bbox="559 412 1443 441">The wheels may block during braking and ESP[®] does not perform any vehicle stabilization.</p> <p data-bbox="559 448 1652 498">The steerability and braking characteristics are heavily impaired and the braking distance may increase. In addition, other driving safety systems are switched off.</p> <ul style="list-style-type: none"> <li data-bbox="559 508 778 537">► Drive on carefully. <li data-bbox="559 544 1341 573">► Have ABS and ESP[®] checked immediately at a qualified specialist workshop. </div>
 <p data-bbox="195 692 458 740">Currently Unavailable See Operator's Manual</p>	<p data-bbox="524 596 1692 660">* ESP[®] is temporarily unavailable. Other driving systems and driving safety systems (e.g. BAS) may also be malfunctioning.</p> <div data-bbox="550 674 1692 841" style="border: 1px solid black; padding: 5px;"> <p data-bbox="559 681 1114 710">▲ WARNING Risk of skidding if ESP is malfunctioning[®]</p> <p data-bbox="559 723 1674 772">If ESP[®] is malfunctioning, ESP[®] cannot carry out vehicle stabilization. In addition, other driving safety systems are switched off.</p> <ul style="list-style-type: none"> <li data-bbox="559 783 1618 832">► Drive carefully on a suitable stretch of road, making slight steering movements at a speed above 19 mph (30 km/h). </div>





Display messages	Possible causes/consequences and ► Solutions
	<ul style="list-style-type: none"> ► If the display message does not disappear, consult a qualified specialist workshop immediately. Drive carefully.
<div data-bbox="155 335 312 418" style="border: 1px solid black; padding: 5px; text-align: center;">  </div> <p data-bbox="144 425 417 474">Inoperative See Operator's Manual</p>	<p data-bbox="476 335 724 360">* ESP® is malfunctioning.</p> <p data-bbox="495 370 1350 395">Other driving systems and driving safety systems (e.g. BAS) may also be malfunctioning.</p> <p data-bbox="495 406 1641 430">The brake system will continue to operate normally. Braking distance may increase in an emergency braking situation.</p> <div data-bbox="500 446 1646 487" style="background-color: #f0f0f0; padding: 5px;"> <p data-bbox="506 456 1064 481">▲ WARNING Risk of skidding if ESP® is malfunctioning</p> </div> <p data-bbox="510 498 1622 550">If ESP® is malfunctioning, ESP® cannot carry out vehicle stabilization. In addition, other driving safety systems are switched off.</p> <ul style="list-style-type: none"> ► Drive on carefully. ► Have ESP® checked at a qualified specialist workshop.

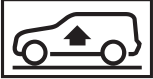

Display messages	Possible causes/consequences and ► Solutions
 <p data-bbox="194 512 471 564">Inoperative See Operator's Manual</p>	<p data-bbox="526 248 1404 310">* EBD, ABS and ESP® are malfunctioning. Other driving systems and driving safety systems (e.g. BAS) may also be malfunctioning.</p> <div data-bbox="545 326 1690 543" style="border: 1px solid gray; padding: 5px;"> <p data-bbox="554 336 1275 367">▲ WARNING Risk of skidding if EBD, ABS and ESP® are malfunctioning</p> <p data-bbox="563 378 1441 409">The wheels may block during braking and ESP® does not perform any vehicle stabilization.</p> <p data-bbox="563 414 1653 466">The steerability and braking characteristics are heavily impaired and the braking distance may increase. In addition, other driving safety systems are switched off.</p> <ul data-bbox="563 471 1367 533" style="list-style-type: none"> <li data-bbox="563 471 776 502">► Drive on carefully. <li data-bbox="563 507 1367 533">► Have the brake system checked immediately at a qualified specialist workshop. </div>
 <p data-bbox="194 673 231 704">Off</p>	<p data-bbox="526 585 1635 647">* The HOLD function is deactivated because the vehicle is slipping or a condition for activation is not fulfilled. ► Reactivate the HOLD function later or check the activation conditions for the HOLD function (→ page 230).</p>
 <p data-bbox="194 818 471 870">ATTENTION ASSIST: Take a Break!</p>	<p data-bbox="526 725 1552 782">* ATTENTION ASSIST has detected fatigue or an increasing lack of concentration on the part of the driver (→ page 233).</p> <ul data-bbox="545 787 840 813" style="list-style-type: none"> <li data-bbox="545 787 840 813">► If necessary, take a break.

Display messages	Possible causes/consequences and ► Solutions
 <p>--- mph</p>	<ul style="list-style-type: none"> * Cruise control cannot be activated as not all activation conditions are fulfilled. <ul style="list-style-type: none"> ► Observe the activation conditions for cruise control (→ page 235).
Cruise Control Inoperative	<ul style="list-style-type: none"> * Cruise control is malfunctioning. <ul style="list-style-type: none"> ► Consult a qualified specialist workshop.
Cruise Control Off	<ul style="list-style-type: none"> * Cruise control has been deactivated. <ul style="list-style-type: none"> If there is an additional warning tone, cruise control has been deactivated automatically (→ page 234).
Traffic Sign Assist Currently Unavailable See Operator's Manual	<ul style="list-style-type: none"> * Traffic Sign Assist is temporarily unavailable. <ul style="list-style-type: none"> Once the cause of the problem is no longer present, the system will be available again. ► Continue driving in compliance with traffic regulations.
Traffic Sign Assist Inoperative	<ul style="list-style-type: none"> * Traffic Sign Assist is malfunctioning. <ul style="list-style-type: none"> ► Continue driving in compliance with traffic regulations. or ► Stop the vehicle in accordance with the traffic conditions and restart the vehicle. ► If the display message does not disappear: consult a qualified specialist workshop.

Display messages	Possible causes/consequences and ► Solutions
 <p data-bbox="195 339 458 391">Malfunction Drive at Max. 50 mph</p>	<p data-bbox="524 249 1554 275">* AIRMATIC is functioning only to a limited extent. The vehicle's handling characteristics may be affected.</p> <div data-bbox="547 291 1696 436" style="border: 1px solid black; padding: 5px;"> <p data-bbox="559 301 1535 327">! NOTE The tires on the front axle or the fenders could be damaged by large steering movements</p> <ul style="list-style-type: none"> <li data-bbox="559 342 1341 368">► Avoid large steering movements while driving and listen for scraping sounds. <li data-bbox="559 373 1665 425">► If you hear scraping sounds, pull over and stop the vehicle in accordance with the traffic conditions, and set a higher vehicle level if possible. </div> <ul style="list-style-type: none"> <li data-bbox="547 451 1452 477">► Drive in a manner appropriate for the current level, but do not exceed 50 mph (80 km/h). <li data-bbox="547 482 966 508">► Consult a qualified specialist workshop.
 <p data-bbox="195 622 436 674">STOP Vehicle Level Too Low</p>	<p data-bbox="524 529 1134 555">* You have pulled away despite the vehicle level being too low.</p> <ul style="list-style-type: none"> <li data-bbox="547 560 1591 612">► Pull over and stop the vehicle safely as soon as possible, paying attention to road and traffic conditions. The vehicle will be raised to the selected vehicle level. <li data-bbox="547 622 1184 648">► Wait until the display message disappears before pulling away. <p data-bbox="547 674 1554 700">If the display message does not disappear and a warning tone also sounds, AIRMATIC is malfunctioning:</p> <ul style="list-style-type: none"> <li data-bbox="547 705 1461 731">► No faster than 50 mph (80 km/h) and consult a qualified specialist workshop immediately. <div data-bbox="547 757 1696 841" style="border: 1px solid black; padding: 5px;"> <p data-bbox="559 767 1535 793">! NOTE The tires on the front axle or the fenders could be damaged by large steering movements</p> <ul style="list-style-type: none"> <li data-bbox="559 809 1341 835">► Avoid large steering movements while driving and listen for scraping sounds. </div>



Display messages	Possible causes/consequences and ► Solutions
	<p>► If you hear scraping sounds, pull over and stop the vehicle in accordance with the traffic conditions, and set a higher vehicle level if possible.</p> <p>► Set a higher vehicle level (→ page 271). Depending on the malfunction, the vehicle will be raised.</p>
 <p>Lowering</p>	<p>* The vehicle level will lower for the following reasons:</p> <ul style="list-style-type: none"> • You have selected a different drive program. • You have exceeded the speed limit. • You have changed the vehicle level by pressing the button. • Operation with a trailer or bicycle rack: if an electrical connection has been correctly made, you have exceeded the speed limit.
 <p>Rising</p>	<p>* Your vehicle is adjusting to the level you have selected.</p>
 <p>Vehicle Rising Please Wait</p>	<p>* The vehicle level is too low. The vehicle will be raised to the selected vehicle level.</p> <p>► Wait until the display message disappears before pulling away.</p>

Display messages	Possible causes/consequences and ► Solutions
 <p data-bbox="194 341 406 367">Drive at Max. 12mph</p>	<ul style="list-style-type: none"> * AIRMATIC is functioning only to a limited extent. The current level is too high. The vehicle's handling characteristics may be affected. <ul style="list-style-type: none"> ► No faster than 12 mph (20 km/h). ► Consult a qualified specialist workshop.
 <p data-bbox="194 481 425 507">Compressor Is Cooling</p>	<ul style="list-style-type: none"> * Due to frequent level changes within a short space of time, the compressor first needs to cool down in order to set the selected vehicle level. When the compressor has cooled down, the vehicle will continue rising to the selected vehicle level. <ul style="list-style-type: none"> ► Drive on in a manner appropriate for the current level. Make sure that there is sufficient ground clearance.
 <p data-bbox="194 621 314 647">Slow Down</p>	<ul style="list-style-type: none"> * You are driving too fast for the selected vehicle level. <ul style="list-style-type: none"> ► Drive more slowly and then select the desired vehicle level again. You are driving too quickly with a trailer or the trailer hitch socket is being used, e.g. for a rear bicycle rack. <ul style="list-style-type: none"> ► Read the notes on trailer operation.
 <p data-bbox="194 782 434 808">Not in Curr. Drive Prog.</p>	<ul style="list-style-type: none"> * The Downhill Speed Regulation is not available in the currently selected drive program. <ul style="list-style-type: none"> ► Change the drive program.

Display messages	Possible causes/consequences and ► Solutions
 <p>DSR Inoperative</p>	<ul style="list-style-type: none"> * The Downhill Speed Regulation is malfunctioning. <ul style="list-style-type: none"> ► Consult a qualified specialist workshop.
 <p>DSR Max. Speed 25 mph</p>	<ul style="list-style-type: none"> * The maximum speed of 25 mph (40 km/h) for the Downhill Speed Regulation has been exceeded. <ul style="list-style-type: none"> ► Drive more slowly.



Driver assistance systems

Display messages	Possible causes/consequences and ► Solutions
 <p>--- mph</p>	<ul style="list-style-type: none"> * Active Distance Assist DISTRONIC cannot be activated as not all activation conditions are fulfilled. <ul style="list-style-type: none"> ► Comply with the activation conditions of Active Distance Assist DISTRONIC (→ page 239).

Display messages	Possible causes/consequences and ► Solutions
 <p data-bbox="194 336 314 367">Suspended</p>	<p data-bbox="526 248 1690 300">* If you depress the accelerator pedal beyond the setting of Active Distance Assist DISTRONIC, the system will switch to passive mode (→ page 237).</p>
 <p data-bbox="194 481 231 507">Off</p>	<p data-bbox="526 388 1690 440">* Active Distance Assist DISTRONIC was deactivated. If a warning tone also sounds, Active Distance Assist DISTRONIC has deactivated automatically (→ page 239).</p>
<p data-bbox="194 528 471 606">Active Distance Assist Currently Unavailable See Operator's Manual</p>	<p data-bbox="526 528 1690 626">* Active Distance Assist DISTRONIC is temporarily unavailable. The ambient conditions are outside the system limits (→ page 237). As soon as the ambient conditions are within the system limits, the system will become available again.</p> <p data-bbox="545 631 757 657">► Drive on carefully.</p> <p data-bbox="545 668 572 694">or</p> <p data-bbox="545 699 1672 751">► If the display message does not disappear, stop the vehicle in accordance with the traffic conditions and restart the vehicle.</p>
<p data-bbox="194 771 471 818">Active Distance Assist Inoperative</p>	<p data-bbox="526 771 1690 828">* Active Distance Assist DISTRONIC is malfunctioning. Other driving systems and driving safety systems may also be malfunctioning.</p> <p data-bbox="545 833 757 859">► Drive on carefully.</p>

Display messages	Possible causes/consequences and ► Solutions
	<p>or</p> <ul style="list-style-type: none"> ► Stop the vehicle in accordance with the traffic conditions and restart the vehicle. ► If the display message does not disappear: consult a qualified specialist workshop.
Active Distance Assist Now Available	<ul style="list-style-type: none"> * Active Distance Assist DISTRONIC is operational again. ► Switch on Active Distance Assist DISTRONIC (→ page 239).
Active Brake Assist Functions Currently Limited See Operator's Manual	<ul style="list-style-type: none"> * For vehicles with the Driving Assistance Package, the following functions may be temporarily unavailable or only partially available: <ul style="list-style-type: none"> • Active Brake Assist with cross-traffic function • Evasive Steering Assist • PRE-SAFE® PLUS <p>Vehicles with Blind Spot Assist: PRE-SAFE® PLUS is temporarily unavailable.</p> <p>The ambient conditions are outside the system limits (→ page 254).</p> <ul style="list-style-type: none"> ► Drive on carefully. ► As soon as the ambient conditions are within the system limits, the system will become available again. <p>or</p> <ul style="list-style-type: none"> ► If the display message does not disappear, stop the vehicle in accordance with the traffic conditions and restart the vehicle.

Display messages	Possible causes/consequences and ► Solutions
<p>Active Brake Assist Functions Limited See Operator's Manual</p>	<p>* For vehicles with the Driving Assistance Package, the following functions may be temporarily unavailable or only partially available:</p> <ul style="list-style-type: none"> • Active Brake Assist with cross-traffic function • Evasive Steering Assist • PRE-SAFE® PLUS <p>► Drive on carefully.</p> <p>or</p> <p>► Stop the vehicle in accordance with the traffic conditions and restart the vehicle.</p> <p>► If the display message does not disappear: consult a qualified specialist workshop.</p>
<p>Active Steering Assist Currently Unavailable See Operator's Manual</p>	<p>* Active Steering Assist is temporarily unavailable. The ambient conditions are outside the system limits (→ page 246). As soon as the ambient conditions are within the system limits, the system will become available again.</p> <p>► Drive on.</p> <p>► Check the tire pressure if necessary.</p>
<p>Active Steering Assist Inoperative</p>	<p>* Active Steering Assist is malfunctioning. Active Distance Assist DISTRONIC remains available.</p> <p>► Drive on</p> <p>or</p> <p>► Stop the vehicle in accordance with the traffic conditions and restart the vehicle.</p>

Display messages	Possible causes/consequences and ► Solutions
	<p>► If the display message does not disappear: consult a qualified specialist workshop.</p> <p>* Active Steering Assist has reached the system limits (→ page 246). You have not steered independently for a considerable period of time.</p> <p>► Take over the steering and drive on in accordance with the traffic conditions.</p>
<p>Active Steering Assist Currently Unavailable Due to Multiple Emergency Stops</p>	<p>* Active Steering Assist is temporarily unavailable due to several emergency stops having been performed.</p> <p>► Take over the steering and stop in accordance with the traffic conditions.</p> <p>► Switch the vehicle off and switch it back on. Active Steering Assist is available once more.</p>
 <p>Initiating Emergency Stop</p>	<p>* Your hands are not on the steering wheel. Active Steering Assist will initiate an emergency stop (→ page 246).</p> <p>► Put your hands on the steering wheel.</p> <p>Information on canceling an emergency stop (→ page 248).</p>
<p>Active Emergency Stop Assist Currently Unavailable See Operator's Manual</p>	<p>* Active Emergency Stop Assist is temporarily unavailable. The ambient conditions are outside the system limits (→ page 248). As soon as the ambient conditions are within the system limits, the system will become available again.</p> <p>► Drive on.</p> <p>or</p>

Display messages	Possible causes/consequences and ► Solutions
	<ul style="list-style-type: none"> ► If the display message does not disappear, stop the vehicle in accordance with the traffic conditions and restart the vehicle. * Vehicles without the Driving Assistance Package: Active Emergency Stop Assist is temporarily unavailable due to multiple emergency stops. <ul style="list-style-type: none"> ► Take over the steering and stop in accordance with the traffic conditions. ► Switch the vehicle off and switch it back on. Active Emergency Stop Assist is available once more.
Active Emergency Stop Assist Inoperative	<ul style="list-style-type: none"> * Active Emergency Stop Assist is malfunctioning. <ul style="list-style-type: none"> ► Drive on or ► Stop the vehicle in accordance with the traffic conditions and restart the vehicle. ► If the display message does not disappear: consult a qualified specialist workshop.
Active Lane Change Assist Currently Unavailable See Operator's Manual	<ul style="list-style-type: none"> * Active Lane Change Assist is temporarily unavailable. The ambient conditions are outside the system limits (→ page 250). As soon as the ambient conditions are within the system limits, the system will become available again. <ul style="list-style-type: none"> ► Drive on. or ► If the display message does not disappear, stop the vehicle in accordance with the traffic conditions and restart the vehicle.

Display messages	Possible causes/consequences and ► Solutions
Active Lane Change Assist Inoperative	<p>* Active Lane Change Assist is malfunctioning.</p> <ul style="list-style-type: none">► Drive on. <p>or</p> <ul style="list-style-type: none">► Stop the vehicle in accordance with the traffic conditions and restart the vehicle.► If the display message does not disappear: consult a qualified specialist workshop.
Automatic Lane Change Currently Unavailable See Operator's Manual	<p>* Active Lane Change Assist is temporarily unavailable.</p> <p>The ambient conditions are outside the system limits (→ page 250).</p> <p>As soon as the ambient conditions are within the system limits, the system will become available again.</p> <ul style="list-style-type: none">► Drive on <p>or</p> <ul style="list-style-type: none">► If the display message does not disappear, stop the vehicle in accordance with the traffic conditions and restart the vehicle.
Automatic Lane Change Inoperative	<p>* Active Lane Change Assist is malfunctioning.</p> <ul style="list-style-type: none">► Drive on <p>or</p> <ul style="list-style-type: none">► Stop the vehicle in accordance with the traffic conditions and restart the vehicle.► If the display message does not disappear: consult a qualified specialist workshop.

Display messages	Possible causes/consequences and ► Solutions
<p>Active Stop & Go Assist Currently Unavailable See Operator's Manual</p>	<p>* Active Stop-and-Go Assist is temporarily unavailable. Active Distance Assist DISTRONIC and Active Steering Assist are still available. The ambient conditions are outside the system limits (→ page 237). As soon as the ambient conditions are within the system limits, the system will become available again.</p> <p>► Drive on.</p>
<p>Active Stop & Go Assist Inoperative See Operator's Manual</p>	<p>* Active Stop-and-Go Assist is malfunctioning. Active Stop-and-Go Assist has been deactivated. Active Distance Assist DISTRONIC and Active Steering Assist are still available.</p> <p>► Drive on. or ► Stop the vehicle in accordance with the traffic conditions and restart the vehicle. ► If the display message does not disappear: consult a qualified specialist workshop.</p>
<p>Blind Spot Assist Currently Unavailable See Operator's Manual</p>	<p>* Blind Spot Assist is temporarily unavailable. The system limits have been reached (→ page 264). Once the cause of the problem is no longer present, the system will be available again.</p> <p>► Drive on. or ► If the display message does not disappear, stop the vehicle in accordance with the traffic conditions and restart the vehicle.</p>

510 Display messages and warning/indicator lamps

Display messages	Possible causes/consequences and ► Solutions
Blind Spot Assist Inoperative	<ul style="list-style-type: none">* Blind Spot Assist is malfunctioning.<ul style="list-style-type: none">► Drive onor► Stop the vehicle in accordance with the traffic conditions and restart the vehicle.► If the display message does not disappear: consult a qualified specialist workshop.
Blind Spot Assist Not Available When Towing Trailer See Operator's Manual	<ul style="list-style-type: none">* When you establish the electrical connection to the trailer, Blind Spot Assist will be unavailable.<ul style="list-style-type: none">► Press the left-hand Touch Control and acknowledge the display message.
Active Blind Spot Assist Currently Unavailable See Operator's Manual	<ul style="list-style-type: none">* Active Blind Spot Assist is temporarily unavailable. The system limits have been reached (→ page 264). Once the cause of the problem is no longer present, the system will be available again.<ul style="list-style-type: none">► Drive on.or► If the display message does not disappear, stop the vehicle in accordance with the traffic conditions and restart the vehicle.
Active Blind Spot Assist Inoperative	<ul style="list-style-type: none">* Active Blind Spot Assist is malfunctioning.<ul style="list-style-type: none">► Drive onor► Stop the vehicle in accordance with the traffic conditions and restart the vehicle.

Display messages	Possible causes/consequences and ► Solutions
Active Blind Spot Assist Not Available When Towing Trailer See Operator's Manual	<ul style="list-style-type: none"> ► If the display message does not disappear: consult a qualified specialist workshop. <p>* When you establish the electrical connection to the trailer, Active Blind Spot Assist will be unavailable.</p> <ul style="list-style-type: none"> ► Press the left-hand Touch Control and acknowledge the display message.
Active Lane Keeping Assist Currently Unavailable See Operator's Manual	<p>* Active Lane Keeping Assist is temporarily unavailable. The ambient conditions are outside the system limits (→ page 267). As soon as the ambient conditions are within the system limits, the system will become available again.</p> <ul style="list-style-type: none"> ► Drive on.
Active Lane Keeping Assist Inoperative	<p>* Active Lane Keeping Assist is malfunctioning.</p> <ul style="list-style-type: none"> ► Drive on or ► Stop the vehicle in accordance with the traffic conditions and restart the vehicle. ► If the display message does not disappear: consult a qualified specialist workshop.
Active Lane Keeping Assist Limited Range of Functions See Operator's Manual	<p>* Active Lane Keeping Assist is available but restricted.</p> <ul style="list-style-type: none"> ► Drive on or ► Stop the vehicle in accordance with the traffic conditions and restart the vehicle. ► If the display message does not disappear: consult a qualified specialist workshop.

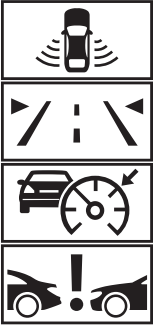
Display messages	Possible causes/consequences and ► Solutions
 <p data-bbox="144 339 408 366">Initiating Emergency Stop</p>	<p data-bbox="476 249 1507 301">* Your hands are not on the steering wheel. The Active Lane Keeping Assist will initiate an emergency stop (→ page 267).</p> <ul style="list-style-type: none"> <li data-bbox="495 311 898 338">► Put your hands on the steering wheel. <p data-bbox="495 353 1079 380">Information on canceling an emergency stop (→ page 248).</p>
 <p data-bbox="144 740 389 792">Temporarily Unavailable Sensors Dirty</p>	<p data-bbox="476 394 1400 421">* Front and corner radar sensors (hereafter "sensors") are malfunctioning. Possible causes are:</p> <ul style="list-style-type: none"> <li data-bbox="500 432 735 458">• The sensors are dirty <li data-bbox="500 469 717 496">• Heavy rain or snow <li data-bbox="500 506 1147 533">• Extended country driving without other traffic, e.g. in the desert <p data-bbox="495 543 1646 595">Driving systems and driving safety systems may be malfunctioning or temporarily unavailable. The brake system, steering and drive system will continue to function normally.</p> <ul style="list-style-type: none"> <li data-bbox="495 606 704 632">► Drive on carefully. <p data-bbox="495 653 1641 705">Once the causes of the problem are no longer present, the driving systems and driving safety systems will be available again and the corresponding symbols will be switched off.</p> <p data-bbox="495 715 907 742">If the display message does not disappear:</p> <ul style="list-style-type: none"> <li data-bbox="495 753 1092 780">► Stop the vehicle in accordance with the traffic conditions. <li data-bbox="495 790 1036 817">► Clean all sensor covers from outside (→ page 225). <li data-bbox="495 827 717 854">► Restart the vehicle.

Display messages	Possible causes/consequences and ► Solutions
	<p>* The view of the multifunction camera is restricted. Possible causes are:</p> <ul style="list-style-type: none"> • Dirt on the windshield in the field of vision of the multifunction camera • Heavy rain, snow or fog • Mist on the inside of the windshield: in certain weather conditions, mist can form on the inside of the windshield during cold times of year in particular. <p>ⓘ This mist on the windshield will be removed automatically within a short time with the aid of a heater. The restriction is temporary.</p> <p>Driving systems and driving safety systems may be malfunctioning or temporarily unavailable. The brake system, steering and drive system will continue to function normally.</p> <p>► Drive on carefully.</p> <p>Once the causes of the problem are no longer present, the driving systems and driving safety systems will be available again and the corresponding symbols will be switched off.</p> <p>If the display message does not disappear:</p> <ul style="list-style-type: none"> ► Stop the vehicle in accordance with the traffic conditions. ► Clean the windshield, especially in the position of the multifunction camera (→ page 225). ► Restart the vehicle.
<p>Camera View Reduced See Operator's Manual</p>	

Display messages	Possible causes/consequences and ► Solutions
 <p data-bbox="144 511 389 560">Functions Limited When Towing Trailer</p>	<p data-bbox="473 249 1448 273">* When the trailer socket is occupied, some driving systems will be available only to a limited extent.</p> <ul data-bbox="495 283 1252 307" style="list-style-type: none"><li data-bbox="495 283 1252 307">► Drive carefully if you are towing a trailer or have the bicycle rack mounted.
<p data-bbox="144 589 421 660">Driver Camera View Currently Restricted See Operator's Manual</p>	<p data-bbox="473 589 1060 613">* The view of the driver camera is reduced. Possible causes:</p> <ul data-bbox="495 623 1234 678" style="list-style-type: none"><li data-bbox="495 623 1234 647">• Objects or stickers are projecting into the driver camera's field of vision.<li data-bbox="495 657 783 678">• The driver camera is dirty. <ul data-bbox="495 699 1641 785" style="list-style-type: none"><li data-bbox="495 699 957 723">► Keep the driver camera's field of vision free.<li data-bbox="495 733 1641 785">► Clean the driver camera if necessary. Please comply with the notes on caring for the interior relating to the display (→ page 387).

Display messages	Possible causes/consequences and ► Solutions
<p>Change the steering wheel/ seat position until 6 dots are visible on the upper edge of the screen.</p>	<ul style="list-style-type: none"> * The driver camera cannot capture your line of sight. <ul style="list-style-type: none"> ► Change the steering wheel and seat position until six dots are visible on the top edge of the screen. The display message will appear again if the driver camera is again unable to detect your line of sight after 30 minutes. ► The display message will no longer appear if you confirm the display message and the driver camera cannot detect your line of sight during the entire journey.
<p>Driver Camera Inoperative See Operator's Manual</p>	<ul style="list-style-type: none"> * The driver camera is malfunctioning. <ul style="list-style-type: none"> ► Consult a qualified specialist workshop.
<p>PRE-SAFE Inoperative See Operator's Manual</p>	<ul style="list-style-type: none"> * The PRE-SAFE® functions are malfunctioning. <ul style="list-style-type: none"> ► Consult a qualified specialist workshop.
<p>PRE-SAFE Pulse Side Inoperative See Operator's Manual</p>	<ul style="list-style-type: none"> * The PRE-SAFE® Impulse Side system is malfunctioning or inoperative after having already been triggered. <ul style="list-style-type: none"> ► Consult a qualified specialist workshop.
<p>PRE-SAFE PLUS Inoperative See Operator's Manual</p>	<ul style="list-style-type: none"> * There is a malfunction in the PRE-SAFE® PLUS system. <ul style="list-style-type: none"> ► Drive on or ► Stop the vehicle in accordance with the traffic conditions and restart the vehicle. ► If the display message does not disappear: consult a qualified specialist workshop.

Parking assistance systems



Display messages	Possible causes/consequences and ► Solutions
<p>PARKTRONIC Inoperative See Operator's Manual</p>	<p>* Parking Assist PARKTRONIC is malfunctioning. Once the cause of the problem is no longer present, the system will be available again.</p> <ul style="list-style-type: none"> ► Continue driving while paying attention to the vehicle's surroundings. <p>or</p> <ul style="list-style-type: none"> ► Stop the vehicle in accordance with the traffic conditions and restart the vehicle. ► If the display message still appears, consult a qualified specialist workshop.
<p>PARKTRONIC and Maneuvering Assistance Unavailable at Rear When Towing Trailer</p>	<p>* If transport equipment, e.g. a trailer or bicycle rack, is attached to the trailer hitch and the electrical connection is correctly established, Parking Assist PARKTRONIC is not available when backing up. The rear maneuvering assistant is also unavailable in this situation.</p> <ul style="list-style-type: none"> ► Press the left-hand Touch Control and acknowledge the display message.
<p>Active Parking Assist and PARKTRONIC Inoperative See Operator's Manual</p>	<p>* Active Parking Assist and Parking Assist PARKTRONIC are malfunctioning. Once the cause of the problem is no longer present, the system will be available again.</p> <ul style="list-style-type: none"> ► Continue driving while paying attention to the vehicle's surroundings. <p>or</p> <ul style="list-style-type: none"> ► Stop the vehicle in accordance with the traffic conditions and restart the vehicle. ► If the display message still appears, consult a qualified specialist workshop.



Display messages	Possible causes/consequences and ► Solutions
<p>Active Parking Assist Limited Availability of Maneuvering Assistance See Operator's Manual</p>	<p>* Active Parking Assist's maneuvering assistant is temporarily unavailable or only partially available.</p> <ul style="list-style-type: none"> ► Clean all sensors of the parking and camera system (→ page 385). ► If the display message still appears, consult a qualified specialist workshop.

Mercedes-Benz emergency call system

Display messages	Possible causes/consequences and ► Solutions
 <p>Inoperative</p>	<p>* The Mercedes-Benz emergency call system is malfunctioning. The Mercedes me connect system is also malfunctioning.</p> <ul style="list-style-type: none"> ► Consult a qualified specialist workshop.



Battery



Display messages	Possible causes/consequences and ► Solutions
 <p data-bbox="144 381 399 433">12 V On-board Electrical System Service Required</p>	<p data-bbox="469 288 1023 314">* The 12 V on-board electrical system is malfunctioning.</p> <ul style="list-style-type: none"> <li data-bbox="493 322 1036 349">► Consult a qualified specialist workshop immediately.
 <p data-bbox="144 550 391 601">Stop Vehicle See Operator's Manual</p>	<p data-bbox="469 456 1300 483">* The 12 V battery is no longer being charged and the condition of charge is too low.</p> <div data-bbox="493 498 1646 619" style="border: 1px solid black; padding: 5px;"> <p data-bbox="506 508 1193 535">! NOTE Possible damage to the drive system if you continue driving</p> <ul style="list-style-type: none"> <li data-bbox="506 550 783 577">► Do not continue driving. <li data-bbox="506 584 931 611">► Consult a qualified specialist workshop. </div> <ul style="list-style-type: none"> <li data-bbox="493 636 1633 687">► Stop the vehicle immediately in accordance with the traffic conditions. Do not continue driving under any circumstances. <li data-bbox="493 695 746 722">► Switch off the vehicle. <li data-bbox="493 729 912 756">► Consult a qualified specialist workshop.



Display messages	Possible causes/consequences and ► Solutions
 <p data-bbox="194 341 443 393">Switch on vehicle to charge the 12 V battery</p>	<p data-bbox="517 248 1275 274">* The vehicle is off and the condition of charge of the 12 V battery is too low.</p> <ul style="list-style-type: none"> <li data-bbox="545 284 1099 310">► Switch off electrical consumers that are not required. <li data-bbox="545 315 794 341">► Drive for 30–60 mins. <p data-bbox="545 347 572 367">or</p> <ul style="list-style-type: none"> <li data-bbox="545 378 1118 404">► Charge the vehicle at a charging station (→ page 200).
 <p data-bbox="194 512 471 590">Stop Vehicle To Charge the 12 V Battery Do Not Switch Off Vehicle</p>	<p data-bbox="517 419 933 445">* The 12 V battery charge level is too low.</p> <ul style="list-style-type: none"> <li data-bbox="545 455 1681 502">► Stop the vehicle immediately in accordance with the traffic conditions. Do not continue driving under any circumstances. <li data-bbox="545 512 831 538">► Leave the vehicle running <li data-bbox="545 549 1007 574">► If the display message disappears: drive on. <li data-bbox="545 585 1376 611">► If the display message does not disappear: consult a qualified specialist workshop.

Tire pressure monitor

Display messages	Possible causes/consequences and ► Solutions
<p data-bbox="194 751 462 802">Tire Pressure Monitor Currently Unavailable</p>	<p data-bbox="517 751 1644 802">* There is interference from a powerful radio signal source. As a result, no signals from the tire pressure sensor are being received. The tire pressure monitoring system is temporarily unavailable.</p> <p data-bbox="545 813 1533 839">The tire pressure monitoring system will restart automatically as soon as the cause has been rectified.</p> <ul style="list-style-type: none"> <li data-bbox="545 849 665 875">► Drive on.

Display messages	Possible causes/consequences and ► Solutions
<p>Tire Pressure Monitor Inoperative</p>	<p>* The tire pressure monitoring system is malfunctioning.</p> <div style="border: 1px solid gray; padding: 5px;"> <p>▲ WARNING There is a risk of an accident if the tire pressure monitoring system is malfunctioning</p> <p>The tire pressure monitoring system cannot issue a warning if there is pressure loss in one or more of the tires. Tires with insufficient tire pressure may impair the driving characteristics as well as steering and braking.</p> <p>► Have the tire pressure monitoring system checked at a qualified specialist workshop.</p> </div>
<p>Tire Pressure Monitor Inoperative Tire Pressure Sensors Missing</p>	<p>* The wheels installed do not have suitable tire pressure sensors. The tire pressure monitoring system is deactivated.</p> <p>► Install wheels with suitable tire pressure sensors.</p>
<div style="border: 1px solid black; width: 40px; height: 40px; margin: 0 auto; text-align: center; line-height: 40px;">  </div> <p>Wheel Sensor(s) Missing</p>	<p>* There is no signal from the tire pressure sensor in at least one wheel. No pressure value is displayed for the affected tire.</p> <p>► Have the faulty tire pressure sensor replaced at a qualified specialist workshop.</p>
<div style="border: 1px solid black; width: 40px; height: 40px; margin: 0 auto; text-align: center; line-height: 40px;">  </div> <p>Check Tires</p>	<p>* The tire pressure in one or more tires has dropped significantly. The wheel position is displayed. A warning tone will also sound.</p> <div style="border: 1px solid gray; padding: 5px;"> <p>▲ WARNING Risk of an accident due to insufficient tire pressure</p> <ul style="list-style-type: none"> • The tires can burst. </div>

Display messages	Possible causes/consequences and ► Solutions
	<ul style="list-style-type: none"> • The tires can wear excessively and/or unevenly. • The driving characteristics as well as the steering and braking may be greatly impaired. <p>You could then lose control of the vehicle.</p> <ul style="list-style-type: none"> ► Observe the recommended tire pressures. ► Adjust the tire pressure if necessary. <ul style="list-style-type: none"> ► Stop the vehicle in accordance with the traffic conditions. ► Check the tire pressure (→ page 411) and the tires.
 <p data-bbox="195 622 445 671">Please Correct Tire Pressure</p>	<p>* The tire pressure is too low in at least one of the tires, or the difference in tire pressure between the individual wheels is too great.</p> <ul style="list-style-type: none"> ► Check the tire pressure and add air, if necessary. ► When the tire pressure is correct, restart the tire pressure monitor (→ page 415).
 <p data-bbox="195 788 445 814">Warning Tire Malfunction</p>	<p>* The pressure in one or more tires has dropped suddenly. The wheel position is displayed.</p> <div style="background-color: #f0f0f0; padding: 5px;"> <p>⚠ WARNING Risk of an accident from driving with a flat tire</p> <ul style="list-style-type: none"> • The tires can overheat and be damaged. • The driving characteristics as well as the steering and braking characteristics may be greatly impaired. </div>

Display messages	Possible causes/consequences and ► Solutions
	<p>You could then lose control of the vehicle.</p> <ul style="list-style-type: none"> ► Do not drive with a flat tire. ► Do not exceed the maximum permissible driving distance in emergency mode and the maximum permissible speed with a flat MOExtended tire. ► Observe the notes on flat tires. <p>Notes on flat tires (→ page 392).</p> <ul style="list-style-type: none"> ► Stop the vehicle in accordance with the traffic conditions. ► Check the tires.
 <p>Tires Overheated</p>	<p>* At least one tire is overheating. The affected tires are displayed in red. At temperatures close to the limit value, the tires are displayed in yellow.</p> <p>▲ WARNING Risk of an accident from driving with overheated tires</p> <p>Overheated tires can burst.</p> <ul style="list-style-type: none"> ► Reduce speed so that the tires cool down.
 <p>Reduce Speed</p>	<p>* At least one tire is overheating. The affected tires are displayed in red. At temperatures close to the limit value, the tires are displayed in yellow.</p>

Display messages	Possible causes/consequences and ► Solutions
	<p>▲ WARNING Risk of an accident from driving with overheated tires</p> <p>Overheated tires can burst.</p> <p>► Reduce speed so that the tires cool down.</p>

Warning and indicator lamps

Overview of indicator and warning lamps

Some systems will perform a self-test when the vehicle is switched on. Some indicator and warning lamps may briefly light up or flash. This behavior is non-critical. These indicator and warning lamps indicate a malfunction only if they light up or flash after the vehicle has been started or during a journey.

Driver's display

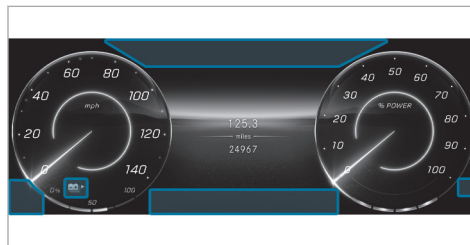

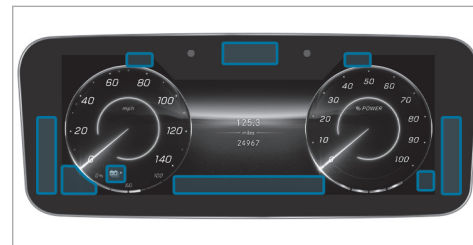

Driver's display with driver camera





Indicator and warning lamps

Occupant safety

-  Restraint system (→ page 525)
-  Seat belt (→ page 525)

524 Display messages and warning/indicator lamps

 Occupant presence reminder (white)
(→ page 525)

 Occupant presence reminder (yellow)
(→ page 525)

Drive system

 Reduced power (→ page 527)

 System error (→ page 527)

 Electrical malfunction (→ page 527)

Vehicle

 Power steering (yellow) (→ page 528)

 Power steering (red) (→ page 528)

 Rear axle steering (yellow) (→ page 528)

 Rear axle steering (red) (→ page 528)

Braking

 Electric parking brake (yellow)
(→ page 530)

PARK USA: electric parking brake (red)
(→ page 530)

 Canada: electric parking brake (red)
(→ page 530)

RBS USA: Recuperative Brake System
(→ page 530)

 Canada: brakes (yellow)(→ page 530)

BRAKE USA: brakes (red) (→ page 530)

 Canada: brakes (red) (→ page 530)

Driving and driving safety systems

 ABS (→ page 533)

 ESP® (→ page 533)

 ESP® OFF (→ page 533)

 ATTENTION ASSIST (→ page 533)

 Traffic Sign Assist (→ page 533)

 Distance warning (→ page 533)

 Active Brake Assist (→ page 533)

 Active Brake Assist (→ page 533)

 Active Brake Assist (→ page 533)

 AIRMATIC (→ page 533)

Mercedes-Benz emergency call system

 Mercedes-Benz emergency call system
(→ page 538)

Tire pressure monitoring system

 Tire pressure monitoring system
(→ page 538)

Exterior lighting

 Standing lights (→ page 145)

 Low beam (→ page 145)

 High beam (→ page 146)

 Turn signal lights (→ page 146)

 Rear fog light (→ page 145)



Symbols on the central display



 Drive Away Assist (→ page 293)

 Rear cross traffic warning (→ page 294)



 Maneuvering brake function (→ page 296)

Occupant safety



Warning/indicator lamp	Possible causes/consequences and ► Solutions
 <p data-bbox="195 384 445 433">Restraint system warning lamp</p>	<p data-bbox="513 291 1175 342">* The restraint system red warning lamp is lit while the vehicle is on. The restraint system is malfunctioning (→ page 47).</p> <div data-bbox="532 360 1698 598" style="border: 1px solid gray; padding: 5px;"> <p data-bbox="541 368 1227 394">▲ DANGER Risk of death due to the restraint system malfunctioning</p> <p data-bbox="547 410 1683 458">Components in the restraint system may be activated unintentionally or not deploy as intended in an accident. In the event of an accident, the high-voltage on-board electrical system may not be deactivated as intended.</p> <p data-bbox="547 469 1633 518">You may receive an electric shock if you touch the damaged components of the high-voltage on-board electrical system.</p> <ul data-bbox="547 531 1507 588" style="list-style-type: none"> <li data-bbox="547 531 1507 557">► Have the restraint system checked and repaired immediately at a qualified specialist workshop. <li data-bbox="547 562 1097 588">► After an accident, switch off the vehicle immediately. </div> <ul data-bbox="528 617 1071 707" style="list-style-type: none"> <li data-bbox="528 617 741 643">► Drive on carefully. <li data-bbox="528 648 975 674">► Note the messages on the driver's display. <li data-bbox="528 679 1071 707">► Consult a qualified specialist workshop immediately.
 <p data-bbox="195 819 421 868">Seat belt warning lamp flashes</p>	<p data-bbox="513 726 1443 778">* The red seat belt warning lamp flashes and an intermittent warning tone sounds. The driver or front passenger has not fastened his/her seat belt while the vehicle is in motion.</p> <ul data-bbox="528 788 1060 871" style="list-style-type: none"> <li data-bbox="528 788 907 814">► Fasten your seat belt (→ page 47). <li data-bbox="528 814 981 840">There are objects on the front passenger seat. <li data-bbox="528 845 1060 871">► Remove the objects from the front passenger seat.

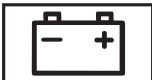

Warning/indicator lamp	Possible causes/consequences and ► Solutions
 <p data-bbox="144 342 371 394">Seat belt warning lamp lights up</p>	<p data-bbox="463 249 1308 272">* The red seat belt warning lamp lights up for six seconds once the vehicle has started.</p> <p data-bbox="476 283 986 306">In addition, an intermittent warning tone may sound.</p> <p data-bbox="476 311 1411 334">The red seat belt warning lamp reminds the driver and front passenger to fasten their seat belts.</p> <p data-bbox="476 344 857 367">► Fasten your seat belt (→ page 47).</p> <p data-bbox="476 386 1463 409">If you have placed objects on the front passenger seat, the red seat belt warning lamp may remain lit.</p>
 <p data-bbox="144 521 371 596">Occupant presence reminder warning lamp (white)</p>	<p data-bbox="463 430 1047 453">* The white occupant presence reminder warning lamp is lit.</p> <p data-bbox="476 458 949 481">The occupant presence reminder is deactivated.</p> <p data-bbox="476 492 1119 514">► Switch on the occupant presence reminder, see (→ page 76).</p>
 <p data-bbox="144 707 417 783">Occupant presence reminder warning lamp (yellow)</p>	<p data-bbox="463 615 1055 638">* The yellow occupant presence reminder warning lamp is lit.</p> <p data-bbox="476 643 972 666">The occupant presence reminder is malfunctioning</p> <p data-bbox="476 676 925 699">► Note the messages on the driver's display.</p>

Drive system



Warning/indicator lamp	Possible causes/consequences and ► Solutions
 <p data-bbox="195 381 421 433">Reduced warning lamp power</p>	<p data-bbox="513 288 981 339">* The yellow reduced-power warning lamp is on. Drive system power output is reduced.</p> <p data-bbox="526 350 975 376">► Note the messages on the driver's display.</p>
 <p data-bbox="195 543 476 595">System malfunction warning lamp</p>	<p data-bbox="513 450 1506 502">* The red system error warning lamp is lit while the vehicle is in a state of operational readiness READY. There is a malfunction in the drive system.</p> <p data-bbox="526 512 975 538">► Note the messages on the driver's display.</p>
 <p data-bbox="195 702 471 754">Electrical malfunction warning lamp</p>	<p data-bbox="513 609 1012 660">* The red electrical malfunction warning lamp is lit. There is a malfunction with the electrics.</p> <p data-bbox="526 671 975 697">► Note the messages on the driver's display.</p>





Vehicle



Warning/indicator lamp	Possible causes/consequences and ► Solutions
 <p data-bbox="144 381 376 433">Power steering warning lamp (yellow)</p>	<p data-bbox="463 291 1188 339">* The yellow power steering warning lamp is lit while the vehicle is running. The power assistance or the steering itself is malfunctioning.</p> <ul style="list-style-type: none"> <li data-bbox="476 350 925 376">► Note the messages on the driver's display.
 <p data-bbox="144 543 376 595">Power steering warning lamp (red)</p>	<p data-bbox="463 453 1160 502">* The red power steering warning lamp is lit while the vehicle is running. The power assistance or the steering itself is malfunctioning.</p> <div data-bbox="482 519 1646 697" style="border: 1px solid black; padding: 5px;"> <p data-bbox="491 529 1114 555">▲ WARNING Risk of accident if steering capability is impaired</p> <p data-bbox="495 567 1369 593">If the steering does not function as intended, the vehicle's operating safety is jeopardized.</p> <ul style="list-style-type: none"> <li data-bbox="495 603 1609 655">► Pull over and stop the vehicle safely as soon as possible, paying attention to road and traffic conditions. Do not continue driving under any circumstances. <li data-bbox="495 666 916 692">► Consult a qualified specialist workshop. </div> <ul style="list-style-type: none"> <li data-bbox="476 717 925 743">► Note the messages on the driver's display.

Warning/indicator lamp	Possible causes/consequences and ► Solutions
 <p>Rear axle steering warning lamp (yellow)</p>	<p>* The yellow rear axle steering warning lamp is lit while the vehicle is running. The rear axle steering is malfunctioning.</p> <ul style="list-style-type: none">► Note the messages on the driver's display.
 <p>Rear axle steering warning lamp (red)</p>	<p>* The red rear axle steering warning lamp is lit while the vehicle is running. The rear axle steering is malfunctioning.</p> <p>⚠ WARNING Risk of accident if steering capability is impaired</p> <p>If the steering does not function as intended, the vehicle's operating safety is jeopardized.</p> <ul style="list-style-type: none">► Pull over and stop the vehicle safely as soon as possible, paying attention to road and traffic conditions. Do not continue driving under any circumstances.► Consult a qualified specialist workshop. <ul style="list-style-type: none">► Note the messages on the driver's display.



Brakes



Warning/indicator lamp	Possible causes/consequences and ► Solutions
 <p>Electric parking brake indicator lamp (red) (USA only)</p>  <p>Electric parking brake indicator lamp (red) (Canada only)</p>  <p>Electric parking brake indicator lamp (yellow)</p>	<p>* The red electric parking brake indicator lamp flashes or is lit. The yellow electric parking brake indicator lamp is also lit in the event of a malfunction.</p> <ul style="list-style-type: none">► Note the messages on the driver's display.



Warning/indicator lamp	Possible causes/consequences and ► Solutions
 <p>RBS warning lamp (USA only)</p>  <p>Brakes warning lamp (yellow) (Canada only)</p>	<p>*The yellow  warning lamp (USA only) or the yellow  brake warning lamp (Canada only) is lit while the vehicle is running.</p> <p>▲ WARNING Risk of an accident due to a brake system malfunction</p> <p>If the brake system is malfunctioning, braking characteristics may be impaired.</p> <ul style="list-style-type: none">► Drive on carefully.► Have the brake system checked immediately at a qualified specialist workshop. <p>The Hill Start Assist may be malfunctioning.</p> <ul style="list-style-type: none">► Adjust your speed and drive on carefully, leaving a suitable distance to the vehicle in front.► If the driver's display shows a display message, observe it.► Consult a qualified specialist workshop.



Warning/indicator lamp	Possible causes/consequences and ► Solutions
 <p>Brakes warning lamp (USA only)</p>  <p>Brakes warning lamp (Canada only)</p>	<p>* The red brake warning lamp is lit while the vehicle is running.</p> <p>Possible causes are:</p> <ul style="list-style-type: none">• The brake force boosting is malfunctioning and the braking characteristics may be affected.• There is insufficient brake fluid in the brake fluid reservoir. <p>► Note the messages on the driver's display.</p> <p>▲ WARNING Risk of accident and injury if brake force boosting is malfunctioning</p> <p>If brake force boosting is malfunctioning, increased brake pedal force may be necessary for braking. The braking characteristics may be impaired. The braking distance can increase in emergency braking situations.</p> <ul style="list-style-type: none">► Stop in a safe location immediately. Do not continue driving.► Consult a qualified specialist workshop. <p>▲ WARNING Risk of an accident due to low brake fluid level</p> <p>If the brake fluid level is too low, the braking effect and the braking characteristics may be impaired.</p> <ul style="list-style-type: none">► Pull over and stop the vehicle safely as soon as possible, paying attention to road and traffic conditions. Do not continue driving under any circumstances.► Consult a qualified specialist workshop.► Do not add brake fluid.



Driving and driving safety systems

Warning/indicator lamp	Possible causes/consequences and ► Solutions
 <p data-bbox="195 381 375 407">ABS warning lamp</p>	<p data-bbox="513 291 1136 339">* The yellow ABS warning lamp is lit while the vehicle is running. ABS is malfunctioning.</p> <p data-bbox="526 350 1112 376">If an additional warning tone sounds, EBD is malfunctioning.</p> <p data-bbox="526 386 1280 412">Other driving systems and driving safety systems may also be malfunctioning.</p> <p data-bbox="526 422 975 448">► Note the messages on the driver's display.</p> <div data-bbox="532 464 1707 676" style="border: 1px solid gray; padding: 5px;"> <p data-bbox="541 469 1252 495">⚠ WARNING There is a risk of skidding if EBD or ABS is malfunctioning</p> <p data-bbox="541 510 901 536">The wheels may lock during braking.</p> <p data-bbox="541 547 1668 595">The steerability and braking characteristics are heavily impaired and the braking distance may increase. In addition, other driving safety systems are switched off.</p> <ul style="list-style-type: none"> <li data-bbox="541 606 759 631">► Drive on carefully. <li data-bbox="541 642 1350 668">► Have the brake system checked immediately at a qualified specialist workshop. </div>
 <p data-bbox="195 785 463 811">ESP® warning lamp flashes</p>	<p data-bbox="513 695 1193 743">* The yellow ESP® warning lamp flashes while the vehicle is in motion. One or more wheels have reached their grip limit (→ page 228).</p> <p data-bbox="526 754 1188 780">► Adapt your driving style to suit the road and weather conditions.</p>

Warning/indicator lamp	Possible causes/consequences and ► Solutions
 <p data-bbox="144 342 426 370">ESP® warning lamp lights up</p>	<p data-bbox="463 249 1332 339">* The yellow ESP® warning lamp is lit while the vehicle is running. ESP® is malfunctioning. Other driving systems and driving safety systems (e.g. BAS) may also be malfunctioning.</p> <p data-bbox="476 348 925 376">► Note the messages on the driver's display.</p> <div data-bbox="482 391 1644 578"><p data-bbox="491 399 1045 427">▲ WARNING Risk of skidding if ESP® is malfunctioning</p><p data-bbox="495 443 1604 493">If ESP® is malfunctioning, ESP® cannot carry out vehicle stabilization. In addition, other driving safety systems are switched off.</p><ul data-bbox="495 505 1060 567" style="list-style-type: none"><li data-bbox="495 505 704 533">► Drive on carefully.<li data-bbox="495 541 1060 567">► Have ESP® checked at a qualified specialist workshop.</div>
 <p data-bbox="144 684 380 712">ESP® OFF warning lamp</p>	<p data-bbox="463 591 1142 646">* The yellow ESP® OFF warning lamp is lit while the vehicle is running. ESP® is deactivated.</p> <p data-bbox="476 658 1193 686">Other driving systems and driving safety systems may also be inoperative.</p> <div data-bbox="482 702 1644 854"><p data-bbox="491 710 1147 738">▲ WARNING Risk of skidding when driving with ESP® deactivated</p><p data-bbox="495 754 1517 782">ESP® does not act to stabilize the vehicle. The availability of further driving safety systems is also limited.</p><ul data-bbox="495 787 1095 849" style="list-style-type: none"><li data-bbox="495 787 704 815">► Drive on carefully.<li data-bbox="495 820 1095 849">► Deactivate ESP® only for as long as the situation requires.</div>

Warning/indicator lamp	Possible causes/consequences and ► Solutions
	<p>If ESP® cannot be activated, ESP® is malfunctioning.</p> <ul style="list-style-type: none"> ► Have ESP® checked immediately at a qualified specialist workshop. <p>► Observe the notes on deactivating ESP® (→ page 228).</p>
 <p>ATTENTION ASSIST warning lamp</p>	<p>* The ATTENTION ASSIST warning lamp is lit. ATTENTION ASSIST is malfunctioning.</p> <ul style="list-style-type: none"> ► Consult a qualified specialist workshop.
 <p>Traffic Sign Assist warning lamp</p>	<p>* The Traffic Sign Assist warning lamp is lit. Traffic Sign Assist is malfunctioning.</p> <ul style="list-style-type: none"> ► Note the messages on the driver's display.
 <p>Distance warning lamp</p>	<p>* The red distance warning lamp lights up while the vehicle is in motion. The distance to the vehicle in front is too small for the speed selected.</p> <p>If there is an additional warning tone, you are approaching an obstacle at too high a speed.</p> <ul style="list-style-type: none"> ► Be prepared to brake immediately. ► Increase the distance.

Warning/indicator lamp	Possible causes/consequences and ► Solutions
 <p data-bbox="144 384 417 433">Active Brake Assist warning lamp</p>	<p data-bbox="476 249 931 275">Function of Active Brake Assist (→ page 254).</p> <p data-bbox="476 291 1480 339">* The Active Brake Assist warning lamp is on. Due to dirty sensors or a malfunction, the system is not available or the range of functions is restricted.</p> <p data-bbox="476 353 925 379">► Note the messages on the driver's display.</p>
 <p data-bbox="144 544 417 593">Active Brake Assist warning lamp</p>	<p data-bbox="476 451 1498 534">* The Active Brake Assist warning lamp is on. The system is switched off or the range of functions has been automatically restricted. This may be the case if the driver is not wearing a seat belt or another driving system has been activated.</p> <p data-bbox="476 544 1064 570">► Observe the notes on Active Brake Assist (→ page 254).</p>
 <p data-bbox="144 705 417 754">Active Brake Assist warning lamp</p>	<p data-bbox="476 612 1415 695">* The Active Brake Assist warning lamp is on. After you drive off, the system's range of functions will be restricted due to the teach-in process. Depending on the ambient conditions, the teach-in process may take a few minutes.</p> <p data-bbox="476 705 1064 731">► Observe the notes on Active Brake Assist (→ page 254).</p>

Warning/indicator lamp	Possible causes/consequences and ► Solutions
 <p data-bbox="194 341 452 393">Suspension warning lamp (yellow)</p>	<p data-bbox="508 248 933 300">* The yellow AIRMATIC warning lamp is lit. A malfunction has occurred in AIRMATIC.</p> <ul style="list-style-type: none"> <li data-bbox="526 305 979 336">► Note the messages on the driver's display.
 <p data-bbox="194 502 452 554">Suspension warning lamp (red)</p>	<p data-bbox="508 409 933 461">* The red AIRMATIC warning lamp is lit. A malfunction has occurred in AIRMATIC.</p> <div data-bbox="535 476 1690 564" style="border: 1px solid black; padding: 5px;"> <p data-bbox="545 486 1302 512">! NOTE The vehicle's driving characteristics will have changed significantly.</p> <ul style="list-style-type: none"> <li data-bbox="545 523 970 554">► Consult a qualified specialist workshop. </div> <ul style="list-style-type: none"> <li data-bbox="526 574 979 606">► Note the messages on the driver's display. <li data-bbox="526 611 951 642">► Consult a qualified specialist workshop.

Mercedes-Benz emergency call system

Warning/indicator lamp	Possible causes/consequences and ► Solutions
 <p>Mercedes-Benz emergency call system warning lamp</p>	<p>*The Mercedes-Benz emergency call system is malfunctioning. The Mercedes me connect system is also malfunctioning.</p> <ul style="list-style-type: none"> ► Consult a qualified specialist workshop.

Tire pressure monitor

Warning/indicator lamp	Possible causes/consequences and ► Solutions
 <p>Tire pressure monitoring system warning lamp flashes</p>	<p>*The yellow tire pressure monitor warning lamp (pressure loss/malfunction) flashes for approximately one minute and then remains lit. The tire pressure monitoring system is malfunctioning.</p> <div style="border: 1px solid gray; padding: 5px; margin-top: 10px;"> <p>▲ WARNING There is a risk of an accident if the tire pressure monitoring system is malfunctioning</p> <p>The tire pressure monitoring system cannot issue a warning if there is pressure loss in one or more of the tires. Tires with insufficient tire pressure may impair the driving characteristics as well as steering and braking.</p> <ul style="list-style-type: none"> ► Have the tire pressure monitoring system checked at a qualified specialist workshop. </div>

Warning/indicator lamp	Possible causes/consequences and ► Solutions
 <p data-bbox="194 341 462 419">Tire pressure monitoring system warning lamp lights up</p>	<p data-bbox="508 248 1450 300">* The yellow tire pressure monitoring system warning lamp (pressure loss/malfunction) is lit. The tire pressure monitoring system has detected tire pressure loss in at least one of the tires.</p> <p data-bbox="535 321 1690 357">▲ WARNING Risk of an accident due to insufficient tire pressure</p> <ul data-bbox="545 362 1432 461" style="list-style-type: none">• The tires can burst.• The tires can wear excessively and/or unevenly.• The driving characteristics as well as the steering and braking may be greatly impaired. <p data-bbox="545 476 951 502">You could then lose control of the vehicle.</p> <ul data-bbox="545 507 997 574" style="list-style-type: none">► Observe the recommended tire pressures.► Adjust the tire pressure if necessary. <ul data-bbox="526 595 1127 657" style="list-style-type: none">► Stop the vehicle in accordance with the traffic conditions.► Check the tire pressure and the tires.

1, 2, 3 ...

(SmartKey) battery.....	79
3D driver's display, 3D instrument cluster Function/notes.....	310
4MATIC.....	200

A

A/C function

activating/deactivating (MBUX).....	168
Activating/deactivating (operating unit).....	167

ABS.....	227
----------	-----

Acceleration increase

Notes.....	185
------------	-----

Accelerator pedal.....	194
------------------------	-----

Accident prevention.....	293
--------------------------	-----

Accident, emergency call.....	367
-------------------------------	-----

Acoustic presence indicator.....	179
----------------------------------	-----

Acoustic vehicle alerting system.....	179
---------------------------------------	-----

Activating/deactivating the acoustic lock- ing verification signal.....	78
--	----

Active Blind Spot Assist

Activating/deactivating.....	267
Brake application.....	266
Exit warning.....	264
Function.....	264
Trailer operation.....	266

Active Brake Assist

Function.....	254
Setting.....	259

Active Distance Assist DISTRONIC

Activating/deactivating.....	239
Active Emergency Stop Assist.....	248
Active Lane Change Assist.....	250
Calling up a speed.....	239
Function.....	237
Increases/decreases the speed.....	239
Route-based speed adaptation.....	242
Storing a speed.....	239

Active Emergency Stop Assist.....	248
-----------------------------------	-----

Active headlamps.....	148
-----------------------	-----

Active Lane Change Assist

Activating/deactivating.....	253
Function.....	250

Active Lane Keeping Assist

Activating/deactivating.....	269
Function.....	267
Setting the sensitivity.....	269
Towing a trailer.....	267

Active light function.....	148
----------------------------	-----

Active Parking Assist

Automatic braking function.....	289
Cross traffic warning.....	294
Drive Away Assist.....	293
Exiting a parking space.....	288
Function.....	284
Maneuvering brake function.....	296
Memory Parking Assist.....	297
Parking.....	286
Pausing.....	289
Remote Parking Assist.....	289

Active Service System PLUS.....	377
---------------------------------	-----

Active Speed Limit Assist.....	241
--------------------------------	-----

Active Steering Assist

Activating/deactivating.....	248
Active Emergency Stop Assist.....	248
Active Lane Change Assist.....	250
Function.....	246

- Active Stop-and-Go Assist**..... 244
- Adaptive cruise control**..... 242
- Adaptive Highbeam Assist**
 Activating/deactivating..... 152
- Adaptive Highbeam Assist Plus**
 Activating/deactivating..... 153
- After-sales service**..... 377
- Air bag**
 Front air bag..... 60
 Inflating..... 55
 Overview..... 60
 PASSENGER AIR BAG indicator lamp..... 49
 Warning lamp..... 47
- Air conditioning menu**
 Air distribution..... 169
 Calling up..... 167
 Climate control..... 168
 Fragrance system..... 171
 Front air conditioning..... 167
 Ionization..... 171
 Rear passenger compartment climate control..... 170
 Selecting climate modes..... 168
- Air distribution**
 Adjusting..... 165, 169
 Setting..... 164
- Air fresher system**..... 171
- Air inlet**..... 381
- Air pressure**..... 411
- Air suspension**..... 270
- Air vents**
 Adjusting..... 177
- Air/water duct**..... 381
- Airflow**
 Adjusting..... 165
 Setting..... 164
- AIRMATIC**
 Setting the vehicle level..... 271
 Vehicle levels..... 270
- Alarm system**..... 107
- All-wheel drive**..... 200
- Alternative route**..... 347
- Ambient lighting**..... 155
- AMG TRACK PACE**
 Configuring..... 340
- Drag Race..... 339
 Function..... 337
 Telemetry display..... 340
 Track Race..... 337
- Animals**..... 57
- Anti-collision**
 Drive Away Assist..... 293
- Anti-lock braking system**..... 227
- Anti-theft alarm system**..... 107
- Anti-theft protection**
 Immobilizer..... 107
- Apps, Mercedes me**
 Mercedes me calls..... 359
 Mercedes me connect..... 362
- Assistance system**..... 226
- ASSYST PLUS**
 Battery disconnection periods..... 378
 Service interval display..... 377
 Service requirements..... 377
- ATA**
 Deactivating the alarm..... 108
 Function..... 107
 Interior protection..... 110

- Interior protection function..... 109
 Tow-away alarm function..... 108
 Tow-away protection..... 109
- ATTENTION ASSIST**
 Function..... 233
 Setting..... 234
- Attention assistant**..... 233
- Authorized Mercedes-Benz Service Center**..... 36
- Authorized workshop**..... 36
- Automatic car wash**..... 381
- Automatic car wash mode**..... 383
- Automatic climate control**..... 168
- Automatic distance control**..... 237
- Automatic driving lights**..... 146
- Automatic emergency call**..... 367
- Automatic front passenger air bag shutoff**
 Function..... 51
 Information (child restraint system on
 the front passenger seat)..... 66
 PASSENGER AIR BAG indicator lamp..... 49
- Automatic measures after an accident**..... 54
- Automatic mirror folding function**..... 163
- Automatic seat adjustment**..... 117
- Automatic transmission**..... 195
- Autonomous braking**..... 254
- AVAS**..... 179
- Axle load**
 Towing a trailer..... 450
- B**
- Bag hook**..... 134
- Ball neck**
 Installing..... 305
- BAS**..... 227
- Basic information**..... 44
- Battery**
 High-voltage battery..... 399
- Battery (12 V battery)**
 Charging..... 399
 Notes..... 398
 Replacing..... 399
 Starting assistance..... 399
- Battery (high-voltage on-board electrical
 system)**..... 448
- Beginner driver mode**
 Activating/deactivating..... 232
 Function..... 232
- Belt**
 Fastening..... 47
 Notes on wearing correctly..... 46
 Releasing..... 60
 To adjust the height..... 47
- Bicycle rack**
 Load capacity..... 449
- Blind Spot Assist**
 Activating/deactivating..... 267
 Function..... 264
- Bluetooth®**
 Connecting a mobile phone..... 358
- Brake Assist**
 Active Brake Assist..... 254
 Brake Assist System..... 227
- Brake Assist System**..... 227
- Brake disks**..... 185
- Brake fluid**..... 443
- Brake force distribution**..... 230
- Brake pads**..... 185

Brakes

ABS (Anti-lock Braking System).....	227
Active Brake Assist.....	254
BAS (Brake Assist System).....	227
Driving tips.....	185
EBD (Electronic Brakeforce Distribution).....	230
Electric parking brake.....	221
Handbrake.....	221
HOLD function.....	230
Limited braking effect (salt-treated roads).....	185
New/replaced brake pads/brake discs..	185
Notes on breaking in a new vehicle.....	185
Parking brake.....	221
Post-collision brake.....	54, 55
Recuperation.....	190

Braking assistance

Brake Assist System.....	227
--------------------------	-----

Breakdown

Changing a wheel.....	431
Flat tire.....	392
Overview of aids.....	24
Tow-starting.....	406
Towing methods.....	400

Transporting the vehicle.....	402
-------------------------------	-----

Breakdown (Roadside Assistance)..... 30**C****Calling the customer center for****Mercedes-Benz..... 360****Calls**

Mercedes me.....	359
Telephone menu.....	358
Using overhead control panel.....	359

Camera

360° camera.....	274, 278
Activating using GPS (reversing camera).....	280
Button.....	280
Cleaning.....	385
Driver camera.....	326
Function.....	274
Information.....	225
Managing activation points.....	280
Off-road function.....	278
Opening the camera cover (rear view camera).....	280
Rear view camera.....	272

Select view.....	280
------------------	-----

Transparent Hood.....	278
-----------------------	-----

Car key..... 77**Car wash**

Automatic car wash.....	381
Power washer.....	383
Washing by hand.....	384

Car-to-X-Communication

Display on map.....	352
---------------------	-----



















Care







































Air/water duct.....	381
Automatic car wash.....	381
Camera.....	385
Car parts.....	385
Decorative foil.....	385
Display.....	387
Exterior lighting.....	385
Head-up display.....	387
Headliner.....	387
Paint.....	384
Plastic trim.....	387
Power washer.....	383
Real wood/trim elements.....	387
Running boards.....	385

































- Seat belts..... 387
- Steering wheel..... 387
- Trailer hitch..... 385
- Vehicle interior..... 387
- Vehicle socket for the high-voltage battery..... 385
- Washing by hand..... 384
- Wheels/rims..... 385
- Cargo compartment cover**
 - Extending/retracting..... 131
 - Removing/installing..... 132
- Cargo tie-down rings**..... 134
- Caring for plastic trim**..... 387
- Caring for rims**..... 385
- Central display**
 - Operating..... 323
- Central locking system**
 - Button..... 84
 - SmartKey..... 78
- Change of address**..... 30
- Change of ownership**..... 30
- Changing a wheel**
 - Installing a new wheel..... 436
- Preparation..... 431
- Raising the vehicle..... 432
- Charge level display**..... 215
- Charge level/charge display**..... 215
- Charging**
 - 12 V battery..... 399
 - At time of departure..... 216
 - Charge level display..... 215
 - Charging cable control panel..... 207
 - Charging station, mode 3..... 204
 - Configuring weekly profile..... 216
 - Ending the charging process (alternating current, mode 2/3)..... 211
 - Ending the charging process (direct current, mode 4)..... 214
 - Indicator lamps on vehicle socket..... 208
 - Mains socket, mode 2..... 203
 - Maximum charging current (mains socket)..... 206
 - Notes on charging the high-voltage battery..... 200
 - Notes on the high-voltage battery..... 399
 - Rapid charging station, mode 4..... 205
 - Starting the charging process (alternating current, mode 2/3)..... 208
 - Starting the charging process (direct current, mode 4)..... 212
 - Stowing the charging cable..... 202
 - USB port..... 126, 141
 - Wallbox, mode 3..... 204
 - Wirelessly charging a mobile phone..... 142
- Charging cable**
 - Control panel..... 207
 - Stowing..... 202
- Charging settings**..... 216
- Checking the coolant level**..... 380
- Child safety lock**
 - Rear door..... 74
 - Side windows (rear passenger compartment)..... 75
- Child seat**
 - Adjusting the vehicle seat..... 68
 - Basic instructions..... 63
 - Front passenger seat..... 66
 - Installing ISOFIX..... 71
 - Rearward-facing..... 68
 - Risks/dangers..... 64
 - Securing on the rear seat with the seat belt..... 73

- Securing to the front passenger seat with the seat belt..... 73
 The most important information in brief.... 62
 Top Tether..... 72
- Children**
- Avoiding dangers in the vehicle..... 64
 Basic instructions..... 63
 Special seat belt retractor..... 70
- Chock**..... 431
- Clean varnish**..... 384
- Cleaning**
- Air/water duct..... 381
 Automatic car wash..... 381
 Car parts..... 385
 Decorative foil..... 385
 Paint..... 384
 Power washer..... 383
 Real wood/trim elements..... 387
 Sensors..... 385
 Vehicle interior..... 387
 Vehicle socket for the high-voltage battery..... 385
 Washing by hand..... 384
- Cleaning carpets**..... 387
- Cleaning seat covers**..... 387
- Climate control**
- Activating/deactivating..... 167
 Activating/deactivating (rear operating unit)..... 167
 Activating/deactivating the A/C function (control panel)..... 167
 Activating/deactivating the A/C function (MBUX)..... 168
 Adjusting..... 167
 Air conditioning menu..... 167
 Air distribution..... 164, 165
 Air vents (front)..... 177
 Air vents (rear passenger compartment)..... 178
 Airflow..... 164, 165
 Automatic control..... 168
 Defrosting a window..... 168
 Defrosting the windshield..... 164, 165
 Defrosting windows..... 170
 Filling capacity for refrigerant and PAG oil..... 446
 Fine particle status display..... 167
 Fragrance system..... 171
 Immediate pre-entry climate control..... 177
- Inserting/removing the flacon (fragrance system)..... 172
 Ionization..... 171
 Notes..... 164
 Operating unit..... 164, 165
 Pre-entry climate control for departure time..... 174
 Pre-entry climate control when the vehicle is unlocked..... 173
 Rear operating unit..... 22
 Rear passenger compartment operating unit..... 166
 Rear window defroster..... 164, 165
 Refrigerant..... 445
 Switching air-recirculation mode on/off..... 170, 171
 Synchronization function..... 170
 Temperature..... 164, 165
 Ventilating with convenience opening.... 101
 Windshield heater..... 173
- COC papers, CERTIFICATE OF CONFORMITY**..... 439
- Cockpit**
- Overview (central display)..... 6
 Overview (MBUX Hyperscreen)..... 8

- Collision detection (parked vehicle)
 Setting..... 223, 224
- Combination switch
 Lights..... 146
 Windshield wipers..... 157
- Commuter route..... 347
- Components relevant to radio regulation
 Declaration of conformity..... 34
- Content sharing menu..... 322
- Control elements:..... 29
- Convenience closing..... 102
- Convenience opening..... 101
- Coolant
 Capacity..... 444
 Notes..... 443
- Cooling..... 164, 165
- Copyright
 License..... 43
- Copyrights
 Trademarks..... 43
- Correct use..... 36
- Cover..... 103
- Cross traffic (warning)..... 294
- Crosswind Assist..... 229
- Cruise control
 Activating/deactivating..... 235
 Calling up a speed..... 235
 Function..... 234
 Requirements:..... 235
 Setting a speed..... 235
 Storing a speed..... 235
- Cup holder
 Rear passenger compartment..... 139
- Cup holders in the rear passenger compartment..... 22
- Customer Assistance Center (CAC)..... 37
- Customer Relations Department..... 37
- D**
- Damage
 Limited protection..... 57
- Damping system ADS PLUS
 AIRMATIC..... 270
 Setting the vehicle level..... 271
- Dashcam
 Notes..... 354
 Selecting a USB device..... 354
 Starting/stopping a video recording..... 355
- Data processing in the vehicle..... 38
- Data protection rights..... 41
- Data storage
 Data protection rights..... 41
 Electronic control units..... 38
 Event Data Recorder..... 42
 MBUX multimedia system/Mercedes
 me connect..... 42
 Online services..... 41
- Daytime running lamps, Daytime running
 lamp mode
 Activating/deactivating..... 154
- Deactivating the alarm..... 108
- Dealership..... 36
- Declaration of conformity
 Components relevant to radio regulation.. 34
- Decorative foil..... 385
- Definitions
 Tires and loading..... 425

- Defrost function..... 168
- Deployed components
 Limited protection..... 57
- Deployment situations..... 55
- Destination entry..... 346
- Diagnostics connection..... 34
- DIGITAL LIGHT
 Activating/deactivating..... 150
 Active headlamps..... 148
 Assistance functions..... 148
 Intelligent Light System..... 148
 Overview..... 148
 Topographical compensation..... 148
- Digital Operator's Manual..... 26
- Digital Vehicle Key
 Locking the vehicle..... 81
 Problem..... 83
 Starting the vehicle..... 183
 Unlocking the vehicle..... 81
- Dinghy towing
 Pulling/towing..... 307
- DIRECT SELECT lever
 Engaging drive position..... 200
- Engaging neutral..... 199
 Engaging park position automatically..... 199
 Engaging reverse gear..... 198
 Function..... 198
 Selecting park position..... 199
- Disconnect device (high-voltage on-board electrical system)..... 180
- Display
 Care..... 387
- Display (driver's display)
 Overview of displays..... 313
- Display message
 Calling up on driver display..... 451
 Notes..... 451
- Display messages
 --- mph..... 502
 --- mph..... 498
 12 V On-board Electrical System Service Required..... 518
 Acoustic Presence Indicator Inoperative..... 466
 Add Washer Fluid..... 483
-  ATTENTION ASSIST: Take a Break!..... 497
-  Automatic Driving Lights Inoperative..... 461
-  Battery Overheated Stop! Everyone Get Out! Outdoors if Possible.. 472
-  Battery Too Low Stop Vehicle Charge Immediately..... 471
-  BRAKE Brake Immediately..... 492
-  Camera View Reduced See Operator's Manual..... 513
-  Charger Cable Connected..... 469
-  BRAKE Check Brake Fluid Level..... 493
-  Check Coolant Level See Operator's Manual..... 467
-  Check Left Low Beam (example).. 461
-  Check Tires..... 520
-  Compressor Is Cooling..... 501
-  Coolant Stop Switch Off Vehicle... 467

-  Currently Not Available Charge High-voltage Battery..... 464
-  Currently Not Available Charging of the High-voltage Battery Not Completed..... 464
-  Currently Unavailable See Operator's Manual..... 494
-  Currently Unavailable See Operator's Manual..... 495
-  Digital Vehicle Key Charge Device..... 460
-  Do Not Leave People or Animals in the Vehicle..... 455
-  Don't Forget Your Key..... 457
-  Drive at Max. 12mph..... 501
-  Drive Power and Range Reduced See Operator's Manual..... 473
-  Front Left Malfunction Service Required (example)..... 452
-  Functions Limited When Towing Trailer..... 514
-  Have High-Voltage System Checked See Operator's Manual..... 473
-  Initializing Key Please Wait..... 457
-  Initializing Key Please Wait..... 460
-  Initiating Emergency Stop..... 506, 512
-  Inoperative See Operator's Manual..... 495
-  Inoperative See Operator's Manual..... 496
-  Inoperative See Operator's Manual..... 497
-  Inoperative..... 517
-  Inoperative..... 502
-  Key Does Not Belong to Vehicle... 460
-  Key Not Detected (red display message)..... 456
-  Key Not Detected (white display message)..... 456
-  Key Not Detected Place Digital Vehicle Key in Mobile Phone Cradle..... 458
-  Key Not Detected..... 458
-  Left Window Airbag Malfunction Service Required (example)..... 453
-  Lowering..... 500
-  Malfunction Drive at Max. 50 mph..... 499
-  Malfunction See Operator's Manual..... 492
-  Malfunction See Operator's Manual..... 461
-  Malfunction Service Required..... 475
-  Malfunction Service Required..... 472
-  Malfunction Stop..... 493
-  Malfunction..... 475
-  Malfunction..... 472
-  Max. Speed 25 mph..... 502
-  Not in Curr. Drive Prog..... 501
-  Obtain a New Key..... 455

- | | | |
|---|---|--|
|  Off..... 503 |  Replace Key Battery..... 456 |  Stop Vehicle To Charge the 12 V Battery Do Not Switch Off Vehicle..... 519 |
| HOLD Off..... 497 |  Replace SmartKey See Operator's Manual..... 459 |  Suspended..... 503 |
| PARK Parking Brake See Operator's Manual..... 488 |  Reserve Level Charge High-Voltage Battery..... 475 |  Switch Off Lights..... 462 |
|  Performance Extremely Limited... 476 |  Restraint System Malfunction Service Required..... 452 |  Switch On Headlights..... 462 |
|  Please Correct Tire Pressure..... 521 |  Rising..... 500 |  Switch on vehicle to charge the 12 V battery..... 519 |
|  Pre-entry Climate Control Available Again via SmartKey after Vehicle Start..... 465 |  Slow Down..... 501 | PARK Switch on Vehicle to Release the Parking Brake..... 491 |
|  Pre-entry Climate Control via SmartKey Currently Not Available. High-voltage Battery Low..... 465 |  Steering Malfunction Drive Carefully Service Required..... 479 |  Take SmartKey With You..... 460 |
|  Rear Axle Steering Currently Malfunctioning..... 480 |  Steering Malfunction Increased Physical Effort See Operator's Manual... 479 |  Temporarily Unavailable Sensors Dirty..... 512 |
|  Rear Axle Steering Malfunction Service Required..... 480 |  Steering Malfunction Stop Immediately See Operator's Manual..... 480 |  Tires Overheated..... 522 |
|  Rear Axle Steering Malfunction Stop Immediately..... 481 |  Stop Switch Off Vehicle..... 475 |  Towing Not Permitted See Operator's Manual..... 466 |
|  Reduce Speed..... 522 |  STOP Vehicle Level Too Low..... 499 |  Vehicle Ready to Drive Shutdown Occurs When Locked or After a Few Minutes..... 478 |
| PARK Release Parking Brake..... 491 |  Stop Vehicle See Operator's Manual..... 518 |  Vehicle Rising Please Wait..... 500 |
| | |  Warning Tire Malfunction..... 521 |

 Washing Fluid Flap Open.....	483	Active Emergency Stop Assist Currently Unavailable See Operator's Manual.....	506	Active Steering Assist Currently Unavailable Due to Multiple Emergency Stops.....	506
 Wheel Sensor(s) Missing.....	520	Active Emergency Stop Assist Inoperative.....	507	Active Steering Assist Currently Unavailable See Operator's Manual.....	505
AC Charging Inoperative Service Required.....	470	Active Lane Change Assist Currently Unavailable See Operator's Manual.....	507	Active Steering Assist Inoperative.....	505
Active Blind Spot Assist Currently Unavailable See Operator's Manual.....	510	Active Lane Change Assist Inoperative...	508	Active Stop & Go Assist Currently Unavailable See Operator's Manual.....	509
Active Blind Spot Assist Inoperative.....	510	Active Lane Keeping Assist Currently Unavailable See Operator's Manual.....	511	Active Stop & Go Assist Inoperative See Operator's Manual.....	509
Active Blind Spot Assist Not Available When Towing Trailer See Operator's Manual.....	511	Active Lane Keeping Assist Inoperative...	511	Adaptive Highbeam Assist Currently Unavailable See Operator's Manual.....	462
Active Brake Assist Functions Currently Limited See Operator's Manual....	504	Active Lane Keeping Assist Limited Range of Functions See Operator's Manual.....	511	Adaptive Highbeam Assist Inoperative....	463
Active Brake Assist Functions Limited See Operator's Manual.....	505	Active Parking Assist and PARKTRONIC Inoperative See Operator's Manual.....	516	Adaptive Highbeam Assist Plus Currently Unavailable See Operator's Manual.....	463
Active Distance Assist Currently Unavailable See Operator's Manual.....	503	Active Parking Assist Limited Availability of Maneuvering Assistance See Operator's Manual.....	517	Adaptive Highbeam Assist Plus Inoperative.....	463
Active Distance Assist Inoperative.....	503			Ambient Lighting Warning Support Inoperative.....	481
Active Distance Assist Now Available.....	504				

Automatic Lane Change Currently Unavailable See Operator's Manual.....	508	Check Brake Pads See Operator's Manual.....	494	Drive Malfunction Achievable Speed Severely Limited See Operator's Manual.....	474
Automatic Lane Change Inoperative.....	508	Close Socket Flap Manually Anti-Trap Protection Active.....	468	Driver Camera Inoperative See Operator's Manual.....	515
Auxiliary Battery Malfunction (white display message).....	487	Close Socket Flap Manually Automatic Not Functioning.....	468	Driver Camera View Currently Restricted See Operator's Manual.....	514
Blind Spot Assist Currently Unavailable See Operator's Manual.....	509	Cruise Control Inoperative.....	498	Front Passenger Airbag Disabled See Operator's Manual.....	453
Blind Spot Assist Inoperative.....	510	Cruise Control Off.....	498	Front Passenger Airbag Enabled See Operator's Manual.....	454
Blind Spot Assist Not Available When Towing Trailer See Operator's Manual....	510	DC Charging Inoperative Service Required.....	470	Hazard Warning Light Malfunction.....	464
Cannot Start Vehicle See Operator's Manual.....	466, 474	Depress Brake to Shift from P.....	484	Head-up Display Brightness Currently Reduced See Operator's Manual.....	479
Change the steering wheel/ seat position until 6 dots are visible on the upper edge of the screen.....	515	Depress Brake to Shift to D or R.....	484	Head-up Display Currently Unavailable See Operator's Manual.....	478
Charge High-Voltage Battery Vehicle Starting Ability Otherwise Not Guaranteed.....	471	Depress Brake to Shift to R.....	484	Head-up Display Inoperative.....	478
Charging Fault Change Charging Mode See Operator's Manual.....	469	DIGITAL LIGHT Functions Limited.....	462	High-Voltage Battery Fault No Start in Approx. XXX mi Service Required (red display message).....	476
		Do Not Restart Vehicle Service Required.....	473		
		Drive Malfunction Achievable Speed Limited Stop Soon.....	474		

High-Voltage Battery Fault No Start in Approx. XXX mi Service Required (yel- low display message).....	476	Place the Key in the Marked Space See Operator's Manual.....	457	Risk of Vehicle Rolling Away N Activa- ted Manually No Automatic Change to P.....	485
Hight-Voltage Battery Fault Do Not Restart Service Required.....	477	PRE-SAFE Inoperative See Operator's Manual.....	515	Service Required Apply Parking Brake to Park.....	484
N Automatically Activated Please Shift to Transmission Position Again.....	486	PRE-SAFE PLUS Inoperative See Operator's Manual.....	515	Service Required Do Not Change Transmission Position.....	487
N is Engaged Shift to Desired Gear.....	486	PRE-SAFE Pulse Side Inoperative See Operator's Manual.....	515	Shift to P Only When Vehicle Is Sta- tionary.....	483
Not Possible to Unlock Charging Cable See Operator's Manual.....	469	Preparing Drive System.....	471	Snow Chain Mode Maximum Speed Exceeded.....	481
Occupant Presence Reminder Inoper- ative.....	455	Reduced Drive System Performance See Operator's Manual.....	470	Socket Flap Blocked Open Manually.....	468
PARKTRONIC and Maneuvering Assis- tance Unavailable at Rear When Tow- ing Trailer.....	516	Restricted Mode Activated Drive Power Reduced.....	478	Tire Pressure Monitor Currently Unavailable.....	519
PARKTRONIC Inoperative See Opera- tor's Manual.....	516	Reversing Not Possible Service Required.....	486	Tire Pressure Monitor Inoperative.....	520
Place SmartKey in Cup Holder or Digi- tal Vehicle Key in Mobile Phone Cra- dle See Operator's Manual.....	457	Risk of Vehicle Rolling Away Apply Parking Brake When Parking.....	485	Tire Pressure Monitor Inoperative Tire Pressure Sensors Missing.....	520
		Risk of Vehicle Rolling Away Driver's Door Open Position P Not Selected.....	485	To Deselect P or N Depress Brake and Start Vehicle.....	484

- To Switch Off Vehicle Press and Hold Start/Stop Button for at Least 3 Seconds or Press 3 Times..... 466
- Traffic Sign Assist Currently Unavailable See Operator's Manual..... 498
- Traffic Sign Assist Inoperative..... 498
- Transmission Malfunction Stop..... 486
- Vehicle Currently Not Charging... Charging Station Fault..... 469
- Wait in READY State Battery Is Warming Up See Operator's Manual..... 471
- Windshield Wiper Malfunction..... 483
- Displaying road names/house numbers..... 347
- Distance control..... 237
- Distance warning..... 254
- DISTRONIC..... 237
- Door
 - Child safety lock (rear door)..... 74
 - Closing the convenience doors..... 87
 - Emergency key..... 92
 - Opening (from the inside)..... 83
 - Opening the convenience doors..... 87
 - Power closing function..... 92
 - Recessed door handles..... 84
 - Setting convenience doors..... 91
 - Unlocking (inside)..... 83
- Door handles
 - Extending/retracting..... 84
- Door operating unit
 - Function seat..... 20
- DOT, Tire Identification Number (TIN)..... 421
- Downhill Speed Regulation..... 244
- Drag Race..... 339
- Drinking and driving..... 185
- Drive Away Assist..... 293
- Drive position..... 200
- Drive program display..... 196
- Drive programs
 - Selecting..... 196
- Drive system
 - Manual switch-off..... 180
 - Starting (emergency operation mode).... 184
- Driver camera
 - Function..... 326
 - Switching on/off..... 328
- Driver's display
 - Head-up display..... 312
 - Menus..... 311
 - Notes..... 309
 - Operating..... 310
 - Service due date..... 377
 - Status displays..... 313
 - Warning/indicator lamps..... 10, 14, 523
- Driver's seat
 - Adjusting electrically..... 112
 - Easy entry and exit feature..... 121
 - Seat heating..... 118
- Driving off-road..... 188
- Driving safety system
 - ABS (Anti-lock Braking System)..... 227
 - Active Brake Assist..... 254
 - ATTENTION ASSIST..... 233
 - BAS (Brake Assist System)..... 227
 - Blind Spot Assist/Active Blind Spot Assist..... 264
 - Cameras..... 225

- Cruise control..... 234
- EBD (Electronic Brakeforce Distribution)..... 230
- ESP® (Electronic Stability Program)..... 228
- Hill Start Assist..... 231
- HOLD function..... 230
- Off-road ABS..... 227
- Overview..... 226
- Radar and ultrasonic sensors..... 225
- STEER CONTROL..... 230
- Traffic Sign Assist..... 259
- Trailer Maneuvering Assist..... 300
- Your responsibility..... 224
- Driving system**..... 226
- Driving tips**
- Acoustic presence indicator (sound generator)..... 179
 - Drinking and driving..... 185
 - Electric mode..... 179
 - General driving tips..... 185
 - Notes on breaking in a new vehicle..... 185
 - Off-road driving..... 188
 - Rear axle steering..... 187
 - Recuperation..... 190
- Drowsiness detection**..... 233
- DSR**
- Activating/deactivating..... 245
 - Changing the target speed..... 245
 - Function..... 244
 - Notes..... 245
- Duplicate key**..... 81
- Dynamic handling control system**..... 228
- DYNAMIC SELECT**
- Calling up the fuel consumption indicator..... 198
 - Configuring drive program I..... 197
 - Displaying vehicle data..... 197
 - Drive program display..... 196
 - Drive programs..... 195
 - Function..... 195
 - Selecting the drive program..... 196
- E**
- Easy entry feature**
- Adjusting..... 122
- Easy exit feature**
- Adjusting..... 122
- EBD, Electronic Brakeforce Distribution**..... 230
- ECO Assist**
- Activating/deactivating..... 194
 - Function..... 192
- ECO display**..... 190
- Electric Intelligence**
- Route with charging stations..... 347
- Electric mode, Notes**..... 179
- Electric parking brake**
- Applying automatically..... 221
 - Emergency braking..... 223
 - Manually applying/releasing..... 222
 - Releasing automatically..... 222
- Electrical fuses**..... 406
- Electronic Stability Program**..... 228
- Emergency**
- Fire extinguisher..... 391
 - First-aid kit (soft sided)..... 391
 - Overview of aids..... 24
 - Reflective safety vest..... 390
 - Warning triangle..... 391
- Emergency braking**
- Active Brake Assist..... 254
 - Brake Assist System..... 227

- Carrying out..... 223
 Electric parking brake/handbrake..... 221
- Emergency key**
 Door..... 92
 Tailgate..... 99
- Emergency operation mode**
 Starting the vehicle..... 184
- Emergency shutoff (high-voltage on-board electrical system)**..... 180
- Emergency start (drive system)**..... 406
- Emergency stop assistant**..... 248
- Emergency Tensioning Devices**
 Inflating..... 55
- Energy flow display**
 Function/notes..... 341
- Engine**
 Engine number..... 441
 Parking (start/stop button)..... 217
 Starting (Digital Vehicle Key)..... 183
- Engine number**..... 441
- Environmentally friendly driving**..... 27
- ESC, Electronic Stability Control**..... 228
- ESP®**
 Activating/deactivating..... 229
 Crosswind Assist..... 229
 Function..... 228
 Trailer stabilization..... 229
- Event Data Recorder**..... 42
- Exit warning**..... 264
- Exiting a parking space**
 Active Parking Assist..... 284
 Drive Away Assist..... 293
 PARKTRONIC..... 280
- Exterior lighting**
 Care..... 385
- Exterior mirrors**
 Parking position..... 162
- F**
- Factory settings**
 MBUX reset function..... 336
- Fatigue detection**..... 233
- Favorites**..... 329
- Fine particle status display**..... 167
- Fire extinguisher**..... 391
- First aid**
 First-aid kit (soft sided)..... 391
- First-aid kit (soft sided)**..... 391
- Fitting accessories**
 Limited protection..... 57
- Flacon**..... 172
- Flat tire**
 Changing a wheel..... 431
 MOExtended..... 393
 Notes..... 392
 TIREFIT kit..... 394
- Flat towing**
 Pulling/towing..... 307
- Floor mats**..... 143
- Fog lamp**..... 146
- Foil covering**
 On camera/sensors..... 225
 Radar and ultrasonic sensors..... 225
- Fragrance**..... 171
- Fragrance system**
 Activating/deactivating..... 171

- Adjusting..... 171
- Inserting/removing the flacon..... 172
- Perfume vial..... 172
- Free software**..... 43
- Frequencies**
 - Mobile phone..... 440
 - Two-way radio..... 440
- Front air bag**
 - Inflating..... 55
- Front headlamps**..... 145
- Front passenger air bag**
 - Disabling/enabling..... 51
- Front passenger air bag shutoff,**
PASSENGER AIR BAG OFF
 - Information (child restraint system on
the front passenger seat)..... 66
- Front passenger seat**
 - Adjusting electrically..... 112
- Fuel consumption indicator**..... 198
- Function in the event of an accident**..... 55
- Function seat**..... 20
- Fuses**
 - Cockpit..... 407
 - Front passenger footwell..... 407
 - Fuse assignment diagram..... 406
 - Notes..... 406
 - Rear passenger compartment..... 407
- G**
- Garage door opener**
 - Clearing the memory..... 221
 - Opening/closing a door..... 221
 - Problem..... 220
- Garage door openers**
 - Programming buttons..... 219
 - Synchronizing the rolling code..... 220
- General driving tips**..... 185
- Genuine parts**..... 27
- Glove box**
 - Opening/closing..... 128
- Grab handles**..... 111
- H**
- Handbrake**..... 221
- Handling characteristics**
 - Unusual..... 409
- HANDS-FREE ACCESS**..... 97
- Haptic accelerator pedal, Pressure point**..... 194
- Hazard warning lights**..... 147
- Hazard warnings**
 - Car-to-X-Communication..... 352
- Head restraint**
 - Adjusting (rear passenger compart-
ment)..... 115
 - Adjusting manually (front, 4-way)..... 114
 - Removing/installing (rear passenger
compartment)..... 116
- Head-up display**
 - Care..... 387
 - Function..... 312
 - Memory function..... 124
 - Operating..... 312
 - Switching on/off..... 313
- Headlamp flashing**..... 146
- Headlamp range control**..... 148
- Headlamps**..... 145

- Heating**
 Activating/deactivating..... 167
 Center console..... 166
 Climate control..... 164, 165
 Rear window..... 165
 Seat..... 118
 Steering wheel..... 121
 Windshield..... 173
- Help call**
 Mercedes-Benz emergency call system.. 367
- High beam**..... 146
- High-voltage battery**
 Charge level display..... 215
 Charging at time of departure..... 216
 Charging cable control panel..... 207
 Charging duration..... 448
 Charging station, mode 3..... 204
 Configuring weekly profile..... 216
 Disconnect device..... 180
 Ending the charging process (alternating current, mode 2/3)..... 211
 Ending the charging process (direct current, mode 4)..... 214
 Energy flow display..... 341
 General notes on charging..... 200
- Mains socket, mode 2..... 203
 Maximum charging current (mains socket)..... 206
 Notes..... 399
 Range..... 448
 Range maximization..... 194
 Rapid charging station, mode 4..... 205
 Starting the charging process (alternating current, mode 2/3)..... 208
 Starting the charging process (direct current, mode 4)..... 212
 Stowing the charging cable..... 202
 Type..... 448
 Wallbox, mode 3..... 204
- High-voltage on-board electrical system**
 Charging cable control panel..... 207
 Disconnect device..... 180
 Indicator lamps on vehicle socket..... 208
 Manual switch-off..... 180
- Hill descent control**..... 244
- Hill Start Assist**..... 231
- HOLD function**
 Function..... 230
 Switching on/off..... 230
- Home screen**
 Central display..... 322
- Hood**
 Opening/closing..... 379
- Identification plate**
 Engine..... 441
 Refrigerant..... 445
 Vehicle..... 441
- Immediate pre-entry climate control**..... 177
- Immobilizer**..... 107
- Inattentiveness detection**..... 233
- Incorrect behavior by vehicle occupants**
 Limited protection..... 57
- Indicator/warning lamp**..... 523
- Indicator/warning lamps**
 PASSENGER AIR BAG..... 49
- Individual drive program**
 Configuring..... 197
- Inside rearview mirror**..... 161

- Installing**
 Snow chains..... 410
 Tires/wheels..... 436
- Intelligent Light System**
 Activating/deactivating..... 150
 Active headlamps..... 148
 Adaptive Highbeam Assist..... 151
 Adaptive Highbeam Assist Plus..... 152
 Assistance functions..... 148
 Overview..... 148
 Topographical compensation..... 148
- Interior lighting**
 Adjusting..... 154
 Ambient lighting..... 155
 Switch-off delay time..... 156
- Interior protection**..... 110
- Internet**
 Mercedes me connect..... 362
 Setting up a Wi-Fi hotspot..... 334
 Web browser..... 365
- Ionization**..... 171
- ISOFIX child seat anchor**
 Installing..... 71
- J**
- Jack**
 Storage location..... 431
- Jump-start connection**..... 399
- K**
- Key**
 Problem..... 81
 Replacement key..... 81
- KEYLESS-GO**
 Deactivating..... 78
 Locking/unlocking the vehicle..... 84
 Problem..... 86
 Unlocking setting..... 78
- Knee air bag**..... 60
- L**
- Lane change assist**..... 250
- Lane Keeping Assist**..... 267
- Lane recognition**
 Active Lane Change Assist..... 250
- Lane recognition (automatic)**
 Active Lane Keeping Assist..... 267
- Language**
 Notes..... 336
 Setting..... 336
- Level control**
 AIRMATIC..... 270
- License plate (front)**..... 34
- License plate assembly (front)**..... 34
- Light switch**..... 145
- Lighting**
 Intelligent Light System..... 148
 Interior lighting..... 154
- Lights**
 Active headlamps..... 148
 Adaptive Highbeam Assist..... 151
 Adaptive Highbeam Assist Plus..... 152
 Assistance functions..... 148
 Automatic driving lights..... 146
 Combination switch..... 146
 DIGITAL LIGHT..... 148
 Hazard warning lights..... 147
 High beam..... 146
 Intelligent Light System..... 148

- Interior lighting..... 154
 - Locator lighting..... 154
 - Reading lamp..... 154
 - Rear fog light..... 146
 - Responsibility for lighting systems..... 145
 - Switch-off delay time..... 154
 - Switching on the daytime running lamps..... 154
 - Switching the Intelligent Light System on/off..... 150
 - Topographical compensation..... 148
 - Turn signals..... 146
 - Limited Warranty**..... 38
 - Live Traffic Information**..... 352
 - Load capacity**
 - Bicycle rack..... 449
 - Load index**
 - Tires..... 423
 - Load-bearing capacity**
 - Tires..... 423
 - Loading**
 - Bag hook..... 134
 - Cargo tie-down rings..... 134
 - Definitions..... 425
 - Roof luggage rack..... 135
 - Loading guidelines**..... 124
 - Loading information table**..... 416
 - Loads**..... 124
 - Locator lighting**..... 154
 - Locking/unlocking**
 - Automatic locking (MMS)..... 87
 - Digital Vehicle Key..... 81
 - Doors (from the inside)..... 83
 - Emergency key..... 92
 - KEYLESS-GO..... 84
 - Loud sound**
 - PRE-SAFE® Sound..... 53
 - Low-beam headlamps**
 - Activating/deactivating..... 145
 - Lubricants**..... 442
 - Luggage**..... 124
 - Luggage rack**..... 124
 - Lumbar support**..... 114
- M**
- Maintaining safe distance**
 - Active Distance Assist DISTRONIC..... 239
 - Maintaining the headliner**..... 387
 - Maintaining the steering wheel**..... 387
 - Maintenance**
 - Vehicle..... 30
 - Maintenance Management**
 - Notes..... 378
 - Transferred data..... 378
 - Malfunction**
 - Restraint system..... 47
 - Malfunction message**
 - Driver's display..... 451
 - Maneuvering**
 - Drive Away Assist..... 293
 - Maneuvering brake function..... 296
 - Maneuvering assistance**
 - Activating/deactivating..... 296
 - Maneuvering assistant**
 - Cross traffic warning..... 294
 - Drive Away Assist..... 293

- Maneuvering brake function..... 296
- Maneuvering brake function**..... 296
- Maneuvering support**..... 294
- Map**
- Displaying online map contents..... 352
 - Displaying weather information..... 352
 - Moving..... 351
 - Selecting the map orientation..... 351
 - Setting the map scale..... 351
- Map functions**..... 351
- Massage program**..... 118
- Massage programs**..... 117, 118
- Maximum full-stop braking**..... 227
- Maximum load rating**..... 422
- Maximum permissible load**
- Calculation example..... 418
 - Determining..... 417
- Maximum tire pressure**..... 422
- MBUX**
- Dashcam..... 354
- MBUX Interior Assistant**
- Camera & parking..... 326
 - Driver camera..... 326
- MBUX multimedia system**
- Activating/deactivating DSR..... 245
 - Air conditioning menu..... 167
 - Calling up the zero layer..... 320
 - Drive programs..... 197
 - Factory setting..... 336
 - Home screen..... 322
 - Language settings..... 325
 - Media..... 370
 - Memory Park Assist..... 300
 - Mercedes me & Apps..... 364
 - Notes..... 315
 - Operating the zero layer..... 320
 - Overview..... 315
 - Set collision detection..... 223, 224
 - Setting route-based speed adaptation... 243
 - Snow chain mode..... 410
 - Steering wheel/seat heating..... 121
 - Telephone..... 356
 - Touchscreen..... 323
 - Zero layer..... 317
- MBUX voice assistant**
- Function..... 325
 - Voice prompting..... 326
- Mechanical key**
- Inserting/removing..... 79
- Media**
- Overview of functions/symbols..... 370
- Medical aids**..... 36
- Memory function**
- Head-up display..... 124
 - Outside mirrors..... 124
 - Seat..... 124
 - Steering wheel..... 124
- Memory Parking Assist**
- Exiting a parking space..... 299
 - Function..... 297
 - Parking..... 299
 - Recording..... 298
 - Setting..... 300
- Menus (driver's display)**
- Notes..... 311
- Mercedes me App**
- Activating on-demand features..... 29
- Mercedes me Apps**..... 364
- Mercedes me calls**
- Arranging a service appointment..... 361

- Calling the Mercedes-Benz customer center after automatic accident/breakdown detection..... 360
- Calls via the overhead control panel..... 359
- Information..... 359
- Mercedes-Benz customer center..... 360
- Transferred data..... 361
- Mercedes me connect**
 - Accident/Breakdown Management..... 363
 - Information..... 362
 - Transferred data..... 364
- Mercedes-AMG vehicles, Notes**..... 179
- Mercedes-Benz emergency call system**
 - Automatic emergency call..... 367
 - Data transfer..... 368
 - Information..... 366
 - Manual emergency call..... 368
 - Overview..... 367
- Mercedes-Benz GenuineParts**..... 27
- Message memory**..... 451
- Mirror heater**..... 173
- Mirrors**
 - Mirror folding function..... 163
 - Outside mirrors..... 160
 - Rearview mirror..... 161
- Mobile phone**
 - Authorizing, Remote Parking Assist..... 293
 - Frequencies..... 440
 - Maximum transmission output..... 440
 - Notes on wireless charging..... 142
 - Wireless charging (front)..... 143
- Model series**..... 441
- Modification**
 - Limited protection..... 57
- MOExtended tires, Run-flat tires**..... 393
- Multimedia system**..... 315
- N**
- Navigation**
 - Activating..... 343
 - Destination entry..... 346
 - Electric Intelligence..... 347
 - Map..... 351
 - Notes..... 342
 - Overview..... 343
 - Route with charging stations..... 347
- Near Field Communication (NFC)**
 - Locking the vehicle (Digital Vehicle Key)... 81
 - Unlocking the vehicle (Digital Vehicle Key)..... 81
- Near-field communication (NFC)**
 - Starting the vehicle (Digital Vehicle Key)..... 183
- Neutral**..... 199
- Notes on breaking in a new vehicle**..... 185
- O**
- Objects in the vehicle interior**
 - Limited protection..... 57
- Occupant presence reminder**
 - Activating/deactivating..... 76
 - Function..... 76
- Occupant safety**
 - Air bag..... 60
 - Basic information..... 44
 - Child seat..... 63
 - Information on the child restraint system..... 51
 - Information on the correct seat position... 45
 - Occupant presence reminder..... 76

- Pets in the vehicle..... 57
 - PRE-SAFE®..... 53
 - Off-road ABS**..... 227
 - Off-road driving**..... 188
 - Off-road menu**
 - Overview..... 341
 - Setting..... 342
 - On-board diagnostics interface**..... 34
 - On-board electronics**
 - Two-way radios..... 439
 - On-demand feature**..... 29
 - Online services**..... 41
 - Open Source Software**..... 43
 - Opening angle**
 - Limiting (tailgate)..... 99
 - Opening the tailgate using your foot**
 - HANDS-FREE ACCESS..... 97
 - Opening/closing a door**..... 221
 - Opening/closing a garage door**..... 221
 - Operating fluids**
 - Brake fluid..... 443
 - coolant..... 443
 - Notes..... 442
 - Refrigerant (air conditioning system)..... 445
 - Windshield washer fluid..... 444
 - Operating safety**..... 31
 - Operator's manual**..... 28
 - Operator's Manual digital**..... 26
 - Outside mirrors**
 - Automatic anti-glare mode..... 161
 - Automatic mirror folding function..... 163
 - Blind Spot Assist/Active Blind Spot Assist..... 264
 - Folding in/out..... 160
 - Memory function..... 124
 - Setting..... 160
 - Warning lamp..... 264
 - Overhead control panel**..... 18
 - Overview of air bags**..... 60
- P**
- Paint code**..... 441
 - Panic alarm, Alarm**
 - Activating/deactivating..... 78
 - Park position**..... 199
 - Parking**
 - Active Parking Assist..... 284
 - PARKTRONIC..... 280
 - Parking Assist**
 - Active Parking Assist..... 284
 - Memory Parking Assist..... 297
 - PARKTRONIC..... 280
 - Remote Parking Assist..... 289
 - Parking Assist PARKTRONIC**
 - Activating/deactivating..... 284
 - Adjusting warning tones..... 284
 - Function..... 280
 - Parking assistance systems**
 - Active Parking Assist..... 284
 - Drive Away Assist..... 293
 - Maneuvering brake function..... 296
 - Memory Parking Assist..... 297
 - PARKTRONIC..... 280
 - Remote Parking Assist..... 289
 - Parking brake**..... 221
 - Parking lamps**..... 145
 - Parking lights**..... 145
 - Parking position**
 - Exterior mirrors..... 162

- Storing the position of the front-passenger outside mirror using reverse gear..... 162
- PARKTRONIC**..... 280
- Partitioning net**..... 132
- PASSENGER AIR BAG**
Status display, front passenger air bag..... 49
- Payload**
Calculation example..... 418
Determining the maximum..... 417
- Permitted towing methods**
Overview..... 400
- Personalization**..... 328
- Pets in the vehicle**..... 57
- Post-collision brake**..... 55
- Power closing function**
Door..... 92
- Power supply**
Start/stop button..... 181
Switching on (start/stop button)..... 181
- Power washer**..... 383
- Pre-entry climate control**
activating/deactivating for departure time..... 176
At time of departure..... 174
For departure time..... 175
immediate..... 177
When vehicle is unlocked..... 173, 174
- Pre-heating**..... 173
- PRE-SAFE®**, Anticipatory occupant protection
Function..... 53
PRE-SAFE® Sound..... 53
Reverting measures..... 53
- PRE-SAFE® Impulse Side**
Function..... 54
Inflating..... 55
- PRE-SAFE® PLUS**
Backing up measures..... 53
Function..... 53
- Preventative occupant protection system**..... 53
- Profile**..... 328
- Program**..... 195
- Protection**
Limited..... 57
- Protection against collision**
Maneuvering brake function..... 296
- Protection of the environment**
Driving style..... 27
- Pulling away**
Drive Away Assist..... 293
Hill Start Assist..... 231
- Q**
- QR code rescue card**..... 38
- Qualified specialist workshop**..... 36
- R**
- Radar and ultrasonic sensors**..... 225
- Radio**..... 372
- Radio regulations**
Regulatory radio identification..... 441
- Rain closing function**
Sliding sunroof..... 106
- Rain sensor**
Sliding sunroof..... 106
Windshield wipers..... 157

- Range**
Notes..... 309
- Range maximization**
Activating/deactivating..... 195
Function..... 194
- Reading lamp**
Interior lighting..... 154
- Rear axle steering**..... 187
- Rear door (child safety lock)**
Securing..... 74
- Rear fog light**..... 146
- Rear passenger compartment climate control**..... 170
- Rear passenger compartment seat**
Adjusting the backrest angle..... 131
- Rear passenger compartment seat belt**
Status display..... 49
- Rear view camera**
360° Camera..... 272
Function..... 272
Opening the camera cover..... 280
- Rear window**
Replacing wiper blade..... 159
- Rear window defroster**..... 164, 165
- Rear window heating**..... 165
- Rear window wiper**
Activating/deactivating..... 157
- Rearview mirror**
Automatic anti-glare mode..... 161
- Rearward-facing child seat**
Information..... 68
- Recuperation**
Function..... 190
Setting..... 191
- Reflective safety vest**..... 390
- Refrigerant**..... 445
- Remote Parking Assist**
Authorizing a mobile phone..... 293
Function..... 289
Operating..... 290
- Replacement key**..... 81
- Reporting safety defects**..... 37
- Resetting**
MBUX reset function..... 336
- Responsibility**
Driving safety systems..... 224
- Restraint system**
Basic information..... 44
Basic instructions for children..... 63
Deployment situations..... 55
Functionality..... 47
Information on function..... 55
Information on the correct seat position... 45
Limited protection..... 57
Malfunction..... 47
Protection..... 45
Self-test..... 47
Warning lamp..... 47
- Reverse gear**..... 198
- Reversing camera**
Activating via GPS..... 280
Care..... 385
Managing activation points..... 280
- Roadside Assistance (breakdown)**..... 30
- Roll away protection**..... 230
- Roller sunblind**
Sliding sunroof..... 103

- Roof luggage rack**
 Loading..... 135
 Securing..... 135
- Route**
 Alternative route..... 347
 Commuter route..... 347
 Electric Intelligence..... 347
 Navigation..... 343
 Selecting a type..... 347
- Route guidance with augmented reality**
 Activating..... 347
 Activating/deactivating the traffic
 light view..... 263
 Displaying road names/house num-
 bers..... 347
 Switching video on or off..... 347
- Route-based speed adaptation**
 Function..... 242
 Setting..... 243
- Run-flat characteristics**..... 393
- Running boards**
 Care..... 385
- S**
- Safety system**..... 226
- Satellite radio**
 Logging in..... 375
 Setting music and sport alerts..... 375
- Seat**
 Adjusting electrically..... 112
 Adjusting the angle of the backrests
 (rear passenger compartment)..... 131
 Automatic adjustment..... 117
 Configuring settings..... 116
 Correct driver's seat position..... 111
 Folding back the backrest (rear
 passenger compartment)..... 130
 Lumbar support..... 114
 Massage programs..... 117
 Memory function..... 124
 Resetting settings (massage programs).. 118
 Settings..... 20
 Side impact air bag..... 60
 Workout programs..... 117
- Seat belt**
 Automatic tightening..... 54
- Rear passenger compartment seat
 belt status display..... 49
 Warning lamp..... 48
- Seat belt adjustment**
 Activating/deactivating..... 54
 Function..... 54
- Seat belt warning**..... 48
- Seat belts**
 Activating/deactivating seat belt
 adjustment..... 54
 Care..... 387
 Fastening..... 47
 Notes on wearing correctly..... 46
 Releasing..... 60
 To adjust the height..... 47
- Seat heating**
 Activating/deactivating..... 118
- Seat height**..... 112
- Seat ventilation**..... 119
- Seats, Back seat, Rear seat, Through-
 loading feature**
 Folding the backrest forwards (rear
 passenger compartment)..... 128

- Selector lever**..... 198
- Self-test**
- Automatic front passenger air bag shut off..... 49
 - Restraint system..... 47
- Sensors**
- Cleaning..... 385
- Service**..... 377
- Service center**..... 36
- Service due date**..... 377
- Service interval display**..... 377
- Shortening the braking distance**
- Brake Assist System..... 227
- Shunting assistant**..... 300
- Side impact air bag**..... 60
- Side windows**
- Child safety lock (rear passenger compartment)..... 75
 - Closing with SmartKey..... 102
 - Convenience closing..... 102
 - Convenience opening..... 101
 - Opening with the SmartKey..... 101
 - Opening/closing..... 100
 - Problem..... 102
- Size designation**
- Tires..... 423
- Skid chains**..... 410
- Sliding sunroof**
- Automatic functions..... 106
 - Closing with SmartKey..... 102
 - Opening with the SmartKey..... 101
 - Opening/closing..... 103
 - Problem..... 106
 - Rain closing function..... 106
- SmartKey**
- Acoustic locking verification signal..... 78
 - Battery..... 79
 - Deactivating a function..... 78
 - Function..... 77
 - Key ring attachment..... 79
 - Mechanical key..... 79
 - Panic alarm..... 78
 - Power consumption..... 78
 - Unlocking setting..... 78
- Smartphone Integration, iPhone®**
- Android Auto..... 365
 - Apple CarPlay®..... 365
- Snow chain mode**..... 410
- Snow chains**..... 410
- Socket**
- 12 V (front passenger footwell)..... 141
- Socket flap**..... 200
- Software update**..... 332
- SOS button**..... 359
- Sound**
- Menu..... 376
 - PRE-SAFE® Sound..... 53
 - Wheels/tires..... 409
- Sound generator**..... 179
- Sound settings**..... 376
- Spare parts**..... 27
- Spare wheel, Emergency spare wheel**..... 438
- Special seat belt retractor**..... 70
- Specialist workshop**..... 36
- speed**
- Save, cruise control..... 239
 - Save, DISTRONIC..... 239
- Speed adaptation, Route-based**..... 242

- Speed control**
 - Active Distance Assist DISTRONIC..... 237
 - Cruise control..... 234
 - Speed rating**
 - Tires..... 423
 - Start-off assist**
 - Drive Away Assist..... 293
 - Hill Start Assist..... 231
 - Start/stop button**
 - Parking the vehicle..... 217
 - Starting the vehicle..... 183
 - Switching on the power supply / vehicle..... 181
 - Starting**
 - Start/stop button..... 183
 - Starting assistance**..... 399
 - Starting the engine**
 - Start/stop button..... 183
 - Starting-off aid**
 - Drive Away Assist..... 293
 - Hill Start Assist..... 231
 - Status display**
 - Front passenger air bag..... 49
 - Rear passenger compartment seat belt.... 49
 - Steer Assist**
 - Active Steering Assist..... 246
 - STEER CONTROL..... 230
 - STEER CONTROL**..... 230
 - Steering**
 - Rear axle steering..... 187
 - Steering wheel**
 - Adjusting electrically..... 120
 - Driver's air bag..... 60
 - Memory function..... 124
 - Steering wheel adjustments**..... 120
 - Steering wheel heating**
 - Linking to the seat heating..... 121
 - Stopping**
 - Parking the vehicle..... 217
 - Stowage areas**..... 126
 - Stowage space**
 - Center console (front)..... 127
 - Stowage spaces**
 - Armrest..... 126
 - Center console (front)..... 126
 - Door..... 126
 - Glove box..... 126
 - Substances hazardous to health**..... 31
 - Suspension**
 - AIRMATIC..... 270
 - Setting the suspension level (AIR-MATIC)..... 271
 - Switch-off delay time**
 - Exterior..... 154
 - Interior..... 156
 - Switching air-recirculation mode on/off**..... 170, 171
 - System settings**
 - MBUX reset function..... 336
 - Overview..... 332
- T**
- Tailgate, Trunk lid**
 - Closing..... 95
 - Emergency key..... 99
 - HANDS-FREE ACCESS..... 97
 - Limiting the opening angle..... 99
 - Opening..... 94

- Technical data**
- Axle load (trailer operation)..... 450
 - Fastening points of the trailer hitch..... 449
 - High-voltage battery..... 448
 - Information..... 439
 - Mounting dimensions of a trailer hitch.... 449
 - Overhang dimension of the trailer hitch.. 449
 - Radio frequencies..... 440
 - Radio regulations..... 441
 - Tongue weight..... 449
 - Towing capacity..... 449
 - Vehicle dimensions..... 446
- Telediagnosis**
- Diagnostic data..... 378
- Telediagnosics**
- Transferred data..... 379
- Telemetry display**..... 340
- Telephone**
- Authorizing a mobile phone, Remote Parking Assist..... 293
 - Bluetooth®..... 358
 - Connecting a mobile phone..... 358
 - Menu..... 358
 - Notes..... 356
 - Notes on wireless charging (mobile phone)..... 142
 - Operating modes..... 358
 - Secure Simple Pairing..... 358
 - Telephone menu overview..... 358
 - Wirelessly charging a(mobile phone, front)..... 143
- Telephony operating modes**
- Bluetooth® telephony..... 358
- Temperature**
- Adjusting..... 165
 - Setting..... 164
- Temperature grade**..... 420
- THERMATIC**
- Air conditioning control panel..... 164
- THERMOTRONIC**
- Air conditioning control panel..... 165
- TIN (Tire Identification Number)**..... 421
- Tire and Loading Information placard**..... 416
- Tire characteristics**..... 423
- Tire information table**..... 416
- Tire labeling**
- Characteristics..... 423
 - DOT, Tire Identification Number (TIN).... 421
 - Load index..... 423
 - Load-bearing capacity..... 423
 - Maximum tire load..... 422
 - Maximum tire pressure..... 422
 - Size designation..... 423
 - Speed rating..... 423
 - Temperature grade..... 420
 - Tire Quality Grading..... 420
 - Traction grade..... 420
 - Tread wear grade..... 420
- Tire pressure**
- Checking..... 415
 - Checking manually..... 413
 - Maximum..... 422
 - Notes..... 411
 - Tire pressure table..... 412
 - TIREFIT kit..... 394
- Tire pressure monitor**
- Function..... 414
- Tire pressure monitoring system**
- Restarting..... 415
- Tire pressure table**..... 412
- Tire Quality Grading**..... 420

- Tire sealant**..... 394
- Tire tread**..... 409
- Tire-change tool**..... 431
- Tire-change tool kit**..... 431
- TIREFIT kit**, Tire inflation compressor
Storage location..... 393
- Tires**
- Breakdown..... 392
 - Characteristics..... 423
 - Checking..... 409
 - Checking the tire pressure manually..... 413
 - Definitions..... 425
 - DOT, Tire Identification Number (TIN)..... 421
 - Installing..... 436
 - Labeling..... 420
 - Load index..... 423
 - Load-bearing capacity..... 423
 - Maximum pressure..... 422
 - Maximum tire load..... 422
 - MOExtended..... 393
 - Noise..... 409
 - Notes on installing..... 427
 - Removing..... 435
 - Removing/installing hub cap..... 432
 - Removing/installing wheel trim..... 432
 - Replacing..... 427, 431
 - Rotating..... 430
 - Selection..... 427
 - Size designation..... 423
 - Snow chains..... 410
 - Speed rating..... 423
 - Storing..... 431
 - Temperature grade..... 420
 - Tire and Loading Information placard..... 416
 - Tire pressure table..... 412
 - Tire Quality Grading..... 420
 - TIREFIT kit..... 394
 - Traction grade..... 420
 - Tread wear grade..... 420
 - Unusual handling characteristics..... 409
- Toll system**
- Debiting toll fees..... 343
 - Windshield..... 163
- Tongue weight**..... 449
- Top Tether**..... 72
- Topographical compensation**, Predictive
headlamp range control..... 148
- Touch Control**
- Driver's display..... 310
 - MBUX..... 323
- Touch-sensitive controls**..... 29
- Touchscreen**..... 323
- Tow bar system**
- Towing away..... 307
- Tow-away protection**..... 109
- Tow-starting**..... 406
- Towing**
- Towing methods..... 400
- Towing a trailer**
- Active Lane Keeping Assist..... 267
 - Axle load..... 450
 - Notes..... 303
- Towing eye**
- installing/removing..... 405
 - Storage location..... 405
- Towing methods**
- Both axles on the ground..... 400
 - Overview..... 400
- Track Race**..... 337

- Traction grade**..... 420
- Traffic information**..... 352
- Traffic Jam Assistant**..... 244
- Traffic light view**
 Activating/deactivating..... 263
 Information..... 263
- Traffic light warning/display**..... 259
- Traffic Sign Assist**
 Function..... 259
 Setting..... 263
- Trailer drawbar, Pulling/towing**..... 307
- Trailer hitch**
 Attaching the ball neck..... 305
 Axle load..... 450
 Care..... 385
 Coupling up/uncoupling a trailer..... 305
 Fastening points..... 449
 General notes..... 449
 Mounting dimensions..... 449
 Overhang dimension..... 449
 Tongue weight..... 449
 Towing capacity..... 449
 Trailer Maneuvering Assist..... 300
- Trailer Maneuvering Assist**
 Function..... 300
 Using..... 302
- Trailer operation**
 Active Blind Spot Assist..... 266
 Attaching the ball neck..... 305
 Coupling up/uncoupling a trailer..... 305
 Setting..... 307
- Trailer stabilization**..... 229
- Transmission**
 DIRECT SELECT lever..... 198
 Drive programs..... 195
 DYNAMIC SELECT button..... 195
 Engaging drive position..... 200
 Engaging neutral..... 199
 Engaging reverse gear..... 198
 Selecting park position..... 199
 Transmission position display..... 198
 Transmission positions..... 198
- Transmission position display**..... 198
- Transporting**
 Vehicle..... 402
- Tread wear grade**..... 420
- TunIn Internet Radio**..... 374
- Turn signal indicator**..... 146
- Turn signals**..... 146
- Two-way radios**
 Frequencies..... 440
 Installation..... 439
 Transmission output..... 440
- U**
- Unfastening**..... 60
- Unlocking setting**..... 78
- Updates**..... 332
- USB port**
 Rear passenger compartment..... 141
 Stowage compartments (front)..... 126
- User profiles**
 Adding a user..... 329
 Note..... 328
 Selecting options..... 329
- V**
- Valet service mode**
 Activating/deactivating..... 232
 Function..... 232

- Vehicle**
- Correct use..... 36
 - Data storage..... 38
 - Diagnostics connection..... 34
 - Emergency key..... 92
 - Equipment..... 28
 - KEYLESS-GO..... 84
 - Limited Warranty..... 38
 - lock automatically (MMS)..... 87
 - Locking (Digital Vehicle Key)..... 81
 - Locking/unlocking (from inside)..... 84
 - Locking/unlocking emergency key..... 92
 - Lowering..... 437
 - Maintenance..... 30
 - Medical aids..... 36
 - Parking..... 217
 - Problem notification..... 37
 - Pulling..... 307
 - QR code rescue card..... 38
 - Raising..... 432
 - Set collision detection..... 223, 224
 - Starting (Digital Vehicle Key)..... 183
 - Starting (emergency operation mode).... 184
 - Starting (start/stop button)..... 183
 - Stopping..... 217
 - Switching off (start/stop button)..... 217
 - Switching on (start/stop button)..... 181
 - Towing away..... 400
 - Transporting..... 402
 - Unlocking (Digital Vehicle Key)..... 81
 - ventilating / convenience opening..... 101
- Vehicle cameras**..... 225
- Vehicle data**
- Angle of approach/departure..... 447
 - Display, MBUX..... 197
 - Displaying, DYNAMIC SELECT..... 197
 - Fording depth..... 447
 - Turning circle..... 446
 - Vehicle height..... 446
 - Vehicle length..... 446
 - Vehicle width..... 446
 - Weights..... 447
 - Wheelbase..... 446
- Vehicle dimensions**..... 446
- Vehicle equipment**..... 28
- Vehicle identification number**..... 441
- Vehicle identification plate**
- Model series..... 441
 - Paint code..... 441
 - VIN..... 441
- Vehicle key**..... 77
- Vehicle level**
- Setting (AIRMATIC)..... 271
- Vehicle operation outside the USA or Canada**..... 30
- Vehicle sensors**..... 225
- Vehicle socket**
- Care..... 385
 - Indicator lamps..... 208
- Vehicle start**
- Start/stop button..... 183
- Vehicle tool kit**
- TIREFIT kit..... 393
 - Towing eye..... 405
- Ventilating**..... 101
- Ventilation**..... 177
- Vents**
- Air vents..... 177
- VIN**
- Engine compartment..... 441
 - Identification plate..... 441
 - Seat..... 441





Vision

- Defrosting windows..... 170
- Windshield heater..... 173

Voice assistant

- Voice prompting..... 326

Voice Control System..... 325**W****Warning system..... 107****Warning triangle..... 391****Warning/indicator lamp**

-  ABS warning lamp..... 533
-  Active Brake Assist warning lamp..... 536
-  ATTENTION ASSIST warning lamp..... 535
-  Brakes warning lamp (Canada only)..... 532
-  BRAKE Brakes warning lamp (USA only)... 532
-  Brakes warning lamp (yellow) (Canada only)..... 531

 Distance warning lamp..... 535

 Electric parking brake indicator lamp (red) (Canada only)..... 530

 PARK Electric parking brake indicator lamp (red) (USA only)..... 530

 Electric parking brake indicator lamp (yellow)..... 530

 Electrical malfunction warning lamp..... 527

 ESP® OFF warning lamp..... 534

 ESP® warning lamp flashes..... 533

 ESP® warning lamp lights up..... 534

 Mercedes-Benz emergency call system warning lamp..... 538

 Occupant presence reminder warning lamp (white)..... 526

 Occupant presence reminder warning lamp (yellow)..... 526

 Power steering warning lamp (red)..... 528

 Power steering warning lamp (yellow)..... 528

 RBS RBS warning lamp (USA only)..... 531

 Rear axle steering warning lamp (red)..... 529

 Rear axle steering warning lamp (yellow)..... 529

 Reduced warning lamp power..... 527

 Restraint system warning lamp..... 525

 Seat belt warning lamp flashes.... 525

 Seat belt warning lamp lights up... 526

 Suspension warning lamp (red).... 537

 Suspension warning lamp (yellow)..... 537

 System malfunction warning lamp..... 527

 Tire pressure monitoring system warning lamp flashes..... 538

 Tire pressure monitoring system warning lamp lights up..... 539

-  Traffic Sign Assist warning lamp... 535
- Warning/indicator lamps**
 - Driver's display..... 523
 - PASSENGER AIR BAG..... 49
- Washer fluid**
 - Topping up..... 381
 - Windshield washer fluid..... 444
- Washing by hand**..... 384
- Water tank**..... 381
- Wear**
 - Limited protection..... 57
- Weather information**..... 352
- Web browser**..... 365
- Weight information**..... 441
- Wheel change**
 - Lowering the vehicle..... 437
 - Removing a wheel..... 435
 - Removing/installing hub caps..... 432
 - Removing/installing wheel trim..... 432
- Wheel rotation**..... 430
- Wheels**
 - Breakdown..... 392
 - Care..... 385
 - Checking..... 409
 - Checking the tire pressure manually..... 413
 - Definitions..... 425
 - DOT, Tire Identification Number (TIN)..... 421
 - Installing..... 436
 - Load index..... 423
 - Load-bearing capacity..... 423
 - Maximum tire load..... 422
 - Maximum tire pressure..... 422
 - MOExtended..... 393
 - Noise..... 409
 - Notes on installing..... 427
 - Removing..... 435
 - Removing/installing hub cap..... 432
 - Removing/installing wheel trim..... 432
 - Replacing..... 427, 431
 - Rotating..... 430
 - Selection..... 427
 - Size designation..... 423
 - Snow chains..... 410
 - Speed rating..... 423
 - Storing..... 431
 - Temperature grade..... 420
 - Tire and Loading Information placard..... 416
 - Tire characteristics..... 423
 - Tire labeling..... 420
 - Tire pressure..... 411
 - Tire pressure monitor..... 414
 - Tire Quality Grading..... 420
 - TIREFIT kit..... 394
 - Traction grade..... 420
 - Tread wear grade..... 420
 - Unusual handling characteristics..... 409
- Wi-Fi**
 - Setting up a hotspot..... 334
- Window curtain air bag**..... 60
- Windows**
 - Care..... 385
 - De-icing..... 168
 - Opening/closing..... 100
 - Removing mist..... 170
- Windshield**
 - De-icing..... 168
 - Defrosting..... 164, 165
 - Infrared reflective..... 163
 - Radio waves..... 163
 - Replacing the wiper blades..... 158
 - Toll system..... 163
- Windshield heater**..... 165, 173

Windshield washer fluid.....	444	Overview.....	318
Windshield washer system.....	381		
Windshield wipers			
Activating/deactivating.....	157		
Replacing the windshield wiper blades....	158		
Replacing the wiper blades.....	158		
Winter operation			
Activating/deactivating snow chain mode.....	410		
Snow chains.....	410		
Wiper blades			
Care.....	385		
Replacing (windshield).....	158		
Wipers.....	157		
Wireless charging			
Mobile phone (front).....	143		
Overview.....	142		
Workout programs.....	117		
Workshop.....	36		
Z			
Zero layer			
Function.....	317		



