

Your Operator's Manual

i **Digital form inside the vehicle**
Familiarize yourself with the contents of the Operator's Manual directly via your vehicle's multimedia system (Menu item "Vehicle").

📖 **Booklet inside the vehicle**
In addition to the vehicle's Operator's Manual, you can obtain the complete multimedia system Supplement from your authorized Mercedes-Benz Center.

🌐 **Digital form via the Internet**
You can find the Operator's Manual on the Mercedes-Benz homepage.

📱 **Digital form as an App**
The Mercedes-Benz Guides App is available for free on the Apple® App store or Google Play.

Apple® iOS



Android™



B-Class

Operator's Manual



2465844001

Order no. P246 0098 13 Part no. 246 584 40 01 Edition B2018

B-Class Operator's Manual

Mercedes-Benz



Symbols

In this Operator's Manual you will find the following symbols:

WARNING

Warning notes make you aware of dangers which could pose a threat to your health or life, or to the health and life of others.

Environmental note

Environmental notes provide you with information on environmentally aware actions or disposal.

 Notes on material damage alert you to dangers that could lead to damage to your vehicle.

 Practical tips or further information that could be helpful to you.

- ▶ This symbol indicates an instruction that must be followed.
 - ▶ Several of these symbols in succession indicate an instruction with several steps.
 - (▷ This symbol tells you where you can find more information about a topic.
- Dis-**
play This text indicates a message on the multifunction display/multimedia display.

Publication details

Internet

Further information about Mercedes-Benz vehicles and about Daimler AG can be found on the following websites:

<http://www.mercedes-benz.ca>

Editorial office

©Daimler AG: not to be reprinted, translated or otherwise reproduced, in whole or in part, without written permission from Daimler AG.

Vehicle manufacturer

Daimler AG
Mercedesstraße 137
70327 Stuttgart
Germany

Welcome to the world of Mercedes-Benz

We urge you to read this Operator's Manual carefully and familiarize yourself with the vehicle before driving. For your own safety and a longer vehicle life, follow the instructions and warning notices in this Operator's Manual. Ignoring them could result in damage to the vehicle or personal injury to you or others.

Vehicle damage caused by failure to follow instructions is not covered by the Mercedes-Benz Limited Warranty.

The equipment or product designation of your vehicle may vary depending on:

- Model
- Order
- Country specification
- Availability

Mercedes-Benz therefore reserves the right to introduce changes in the following areas:

- Design
- Equipment
- Technical features

The equipment in your vehicle may therefore differ from that shown in the descriptions and illustrations.

The following are integral components of the vehicle:

- Printed Operator's Manual
- Maintenance Booklet
- Equipment-dependent supplements

Keep these documents in the vehicle at all times. If you sell the vehicle, always pass all documents on to the new owner.

You can also use the Mercedes-Benz Guides App:

Your Operator's Manual:

Digital form inside the vehicle

The Digital Operator's Manual provides comprehensive and specifically adapted information on your vehicle's equipment and multimedia system. It contains informative animations, individual language settings and an intuitive search function.

Booklet inside the vehicle

In addition to this manual and the aforementioned digital media, you also have the option to obtain a comprehensive printed version of the Supplement for your multi-

media system from your authorized Mercedes-Benz Center.

Digital form via the Internet

The Operator's Manual on the Internet provides easy access to all information regarding your vehicle and multimedia system. It also provides helpful animations, interesting background information and a wide array of search options.

Digital form as an App

Using the Mercedes-Benz Guides App, you can view all the information on your vehicle and multimedia system via mobile Internet or download it independently of network access. Available for smartphones or tablets.

You can also use the Mercedes-Benz Guides App:



Apple® iOS



Android™

Please note that the Mercedes-Benz Guides App may not yet be available in your country.

Mercedes-Benz USA, LLC
Mercedes-Benz Canada, Inc.
A Daimler Company

| | | | |
|---|-----------|---|------------|
| Index | 4 | Mirrors | 88 |
| Digital Operator's Manual | 22 | Memory function | 91 |
| Introduction | 22 | Lights and windshield wipers | 93 |
| Operation | 22 | Exterior lighting | 93 |
| Introduction | 23 | Interior lighting | 95 |
| Protecting the environment | 23 | Replacing bulbs | 96 |
| Genuine Mercedes-Benz parts | 23 | Windshield wipers | 100 |
| Operator's Manual | 24 | Climate control | 104 |
| Service and vehicle operation | 24 | Overview of climate control systems ... | 104 |
| Operating safety | 25 | Operating the climate control systems | 107 |
| QR codes for the rescue card | 27 | Air vents | 112 |
| Data stored in the vehicle | 27 | Driving and parking | 113 |
| Information on copyright | 29 | Notes on breaking-in a new vehicle | 113 |
| At a glance | 30 | Driving | 113 |
| Cockpit | 30 | DYNAMIC SELECT button | 120 |
| Instrument cluster | 31 | Automatic transmission | 121 |
| Multifunction steering wheel | 32 | Refueling | 127 |
| Center console | 33 | Parking | 129 |
| Door control panel | 35 | Driving tips | 131 |
| Overhead control panel | 36 | Driving systems | 138 |
| Safety | 37 | On-board computer and displays | 164 |
| Panic alarm | 37 | Important safety notes | 164 |
| Occupant safety | 37 | Displays and operation | 164 |
| Children in the vehicle | 50 | Menus and submenus | 167 |
| Pets in the vehicle | 56 | Display messages | 177 |
| Driving safety systems | 56 | Warning and indicator lamps in the instrument cluster | 203 |
| Protection against theft | 62 | Multimedia system | 213 |
| Opening and closing | 64 | General notes | 213 |
| SmartKey | 64 | Important safety notes | 213 |
| Doors | 70 | Function restrictions | 213 |
| Cargo compartment | 72 | Operating system | 214 |
| Side windows | 75 | Stowage and features | 221 |
| Panorama roof with power tilt/sliding panel | 79 | Loading guidelines | 221 |
| Seats, steering wheel and mirrors | 83 | Stowage areas | 221 |
| Correct driver's seat position | 83 | Features | 230 |
| Seats | 83 | | |
| Steering wheel | 88 | | |

| | |
|-----------------------------------|------------|
| Maintenance and care | 239 |
| Engine compartment | 239 |
| ASSYST PLUS | 243 |
| Care | 244 |

| | |
|-----------------------------------|------------|
| Breakdown assistance | 251 |
| Where will I find...? | 251 |
| Flat tire | 253 |
| Battery (vehicle) | 258 |
| Jump-starting | 260 |
| Towing and tow-starting | 263 |
| Fuses | 266 |

| | |
|-----------------------------------|------------|
| Wheels and tires | 269 |
| Important safety notes | 269 |
| Operation | 269 |
| Winter operation | 271 |
| Tire pressure | 272 |
| Loading the vehicle | 276 |
| All about wheels and tires | 279 |
| Changing a wheel | 286 |
| Wheel and tire combinations | 290 |
| Emergency spare wheel | 291 |

| | |
|---|------------|
| Technical data | 293 |
| Information regarding technical data ... | 293 |
| Vehicle electronics | 293 |
| Identification plates | 294 |
| Service products and filling capacities | 295 |
| Vehicle data | 300 |

1, 2, 3 ...

4ETS (Electronic Traction System)

see ETS/4ETS (Electronic Traction System)

4MATIC

Display message 200

4MATIC (permanent four-wheel drive)

..... 148

12 V socket

see Sockets

A

ABS (Anti-lock Braking System)

Display message 179

Function/notes 57

Important safety notes 57

Warning lamp 206

Accident

Automatic measures after an accident 50

Activating media mode

General notes 219

Activating/deactivating cooling with air dehumidification

..... 107

Active Brake Assist

Activating or deactivating 174

Display message 184

Function/notes 58

ADAPTIVE BRAKE

..... 62

Adaptive Damping System

Function/notes 148

Additional speedometer

..... 175

Additives (engine oil)

..... 298

Address book

see also Digital Operator's Manual 213

Adjusting the volume

Multimedia system 214

Air bags

Deployment 49

Display message 187

Front air bag (driver, front passenger) 43

Important safety notes 42

Introduction 42

Knee bag 43

Occupant Classification System

(OCS) 44

PASSENGER AIR BAG indicator

lamps 38

Side impact air bag 43

Window curtain air bag 44

Air vents

Important safety notes 112

Rear 112

Setting the center air vents 112

Setting the side air vents 112

Air-conditioning system

see Climate control

Alarm

ATA (Anti-Theft Alarm system) 63

Switching off (ATA) 63

Switching the function on/off

(ATA) 63

Alarm system

see ATA (Anti-Theft Alarm system)

Anti-lock braking system

see ABS (Anti-lock Braking System)

Anti-skid chains

see Snow chains

Anti-theft alarm system

see ATA (Anti-Theft Alarm system)

Ashtray

..... 232

Assistance display (on-board computer)

..... 173

Assistance menu (on-board computer)

..... 172

ASSYST PLUS

Displaying a service message 243

Driving abroad 244

Hiding a service message 243

Information about Service 243

Resetting the service interval display 243

Service message 243

Special service requirements 243

ATA (Anti-Theft Alarm system)

Activating/deactivating 63

Function 63

Switching off the alarm 63

ATTENTION ASSIST

Activating/deactivating 174

Display message 194

Function/notes 158

| | |
|--|-----|
| Audio menu (on-board computer) | 170 |
| Audio system | |
| see Digital Operator's Manual | |
| Authorized Mercedes-Benz Center | |
| see Qualified specialist workshop | |
| Authorized workshop | |
| see Qualified specialist workshop | |
| AUTO lights | |
| Display message | 191 |
| see Lights | |
| Automatic car wash (care) | 244 |
| Automatic engine start (ECO start/ stop function) | 118 |
| Automatic engine switch-off (ECO start/stop function) | 118 |
| Automatic headlamp mode | 93 |
| Automatic transmission | |
| Accelerator pedal position | 123 |
| Changing gear | 123 |
| DIRECT SELECT lever | 121 |
| Drive program | 124 |
| Drive program display | 121 |
| Driving tips | 123 |
| DYNAMIC SELECT button | 120 |
| Emergency running mode | 126 |
| Engaging drive position | 123 |
| Engaging neutral | 122 |
| Engaging park position automati- cally | 122 |
| Engaging reverse gear | 122 |
| Engaging the park position | 121 |
| Holding the vehicle stationary on uphill gradients | 124 |
| Kickdown | 124 |
| Manual shifting | 125 |
| Overview | 121 |
| Problem (malfunction) | 126 |
| Pulling away | 117 |
| Starting the engine | 116 |
| Steering wheel paddle shifters | 125 |
| Transmission position display (DIRECT SELECT lever) | 121 |
| Transmission positions | 123 |
| Automatic transmission emer- gency mode | 126 |

B

| | |
|--|-----|
| Back button | 214 |
| Backup lamp | |
| Display message | 190 |
| Replacing bulbs | 98 |
| Bag hook | 227 |
| BAS (Brake Assist System) | 57 |
| Battery (SmartKey) | |
| Checking | 67 |
| Important safety notes | 67 |
| Replacing | 67 |
| Battery (vehicle) | |
| Charging | 260 |
| Display message | 192 |
| Important safety notes | 258 |
| Jump starting | 260 |
| Belt | |
| see Seat belts | |
| Belt warning | 41 |
| Blind Spot Assist | |
| Activating/deactivating (on- board computer) | 174 |
| Display message | 195 |
| Notes/function | 160 |
| Bluetooth® | |
| Searching for a mobile phone | 217 |
| Searching for a mobile phone (device manager) | 218 |
| see also Digital Operator's Man- ual | 213 |
| Telephony | 217 |
| Brake Assist System | |
| see BAS (Brake Assist System) | |
| Brake fluid | |
| Display message | 184 |
| Notes | 298 |
| Brake force distribution | |
| see EBD (electronic brake force distribution) | |
| Brake lamps | |
| Display message | 189 |
| Brakes | |
| ABS | 57 |
| BAS | 57 |
| Brake fluid (notes) | 298 |
| Braking assistance appropriate to the situation | 59 |

- Display message 179
 - EBD 62
 - Hill start assist 117
 - HOLD function 146
 - Important safety notes 135
 - Maintenance 136
 - Parking brake 130
 - Riding tips 135
 - Warning lamp 205
 - Braking assistance appropriate to the situation**
 - Function/notes 59
 - Breakdown assistance**
 - Where will I find...? 251
 - see Flat tire
 - see Tow-starting
 - see Towing away
 - Brightness control (instrument cluster lighting)** 31
 - Buttons on the steering wheel** 165
- C**
- Calling up a malfunction**
 - see Display messages
 - Car**
 - see Vehicle
 - Care**
 - Car wash 244
 - Carpets 250
 - Display 249
 - Exhaust pipe 248
 - Exterior lights 247
 - Gear or selector lever 249
 - Interior 249
 - Matte finish 246
 - Notes 244
 - Paint 245
 - Plastic trim 249
 - Power washer 245
 - Rear view camera 248
 - Roof lining 250
 - Seat belt 250
 - Seat cover 249
 - Sensors 248
 - Steering wheel 249
 - Trim pieces 249
 - Washing by hand 245
 - Wheels 247
 - Windows 247
 - Wiper blades 247
 - Wooden trim 249
 - Cargo compartment cover**
 - Important safety notes 227
 - Installing/removing 228
 - Notes/how to use 227
 - Cargo compartment enlargement** ... 224
 - Cargo compartment floor**
 - Height adjustment 229
 - Important safety notes 228
 - Opening/closing 228
 - Stowage well (under) 228
 - Cargo tie down rings** 227
 - CD**
 - see also Digital Operator's Manual 213
 - CD player (on-board computer)** 171
 - Center console**
 - Lower section 34
 - Upper section 33
 - Central locking**
 - Automatic locking (on-board computer) 176
 - Locking/unlocking (SmartKey) 64
 - Change of address** 25
 - Change of ownership** 25
 - Changing a wheel**
 - Wheels and tires 287
 - Child**
 - Restraint system 52
 - Child seat**
 - Forward-facing restraint system 55
 - LATCH-type (ISOFIX) child seat anchors 53
 - On the front-passenger seat 54
 - Rearward-facing restraint system 54
 - Top Tether 53
 - Child-proof locks**
 - Important safety notes 55
 - Rear doors 56
 - Children**
 - Special seat belt retractor 51
 - Children in the vehicle**
 - Important safety notes 50
 - Cigarette lighter** 232

- Cleaning**
 Mirror turn signal 248
- Climate control**
 Air-conditioning system 104
 Automatic climate control (dual-zone) 106
 Controlling automatically 108
 Cooling with air dehumidification .. 107
 Defrosting the windows 110
 Defrosting the windshield 109
 General notes 104
 Indicator lamp 108
 Information about using automatic climate control 106
 Notes on using the air-conditioning system 105
 Overview of systems 104
 Problem with the rear window defroster 111
 Problems with cooling with air dehumidification 108
 Refrigerant 299
 Refrigerant filling capacity 300
 Setting the air distribution 108
 Setting the air vents 112
 Setting the airflow 109
 Setting the temperature 108
 Switching air-recirculation mode on/off 111
 Switching on/off 107
 Switching residual heat on/off 111
 Switching the rear window defroster on/off 110
 Switching the ZONE function on/off 109
- Cockpit**
 Overview 30
 see Instrument cluster
- COMAND display**
 Cleaning 249
- Combination switch** 94
- Compass**
 Calibrating 237
 Calling up 236
 Magnetic field zone maps 237
 Setting 237
- Connecting a USB device**
 see also Digital Operator's Manual 213
- Consumption statistics (on-board computer)** 168
- Controller** 214
- Convenience closing feature** 76
- Convenience opening feature** 76
- Coolant (engine)**
 Checking the level 242
 Display message 191
 Filling capacity 299
 Important safety notes 298
 Temperature gauge 165
 Warning lamp 210
- Cooling**
 see Climate control
- Copyright** 29
- Cruise control**
 Activation conditions 139
 Cruise control lever 138
 Deactivating 139
 Display message 197
 Driving system 138
 Function/notes 138
 Important safety notes 138
 Setting a speed 139
 Storing and maintaining current speed 139
- Cup holder**
 Center console 231
 Important safety notes 230
 Rear compartment 231
- Customer Assistance Center (CAC)** 27
- Customer Relations Department** 27
- D**
- Dashboard**
 see Instrument cluster
- Data**
 see Technical data
- Daytime running lamps**
 Display message 191
 Function/notes 93
 Switching on/off (on-board computer) 176

- Declarations of conformity** 26
- Decorative film**
 - Cleaning instructions 246
- Diagnostics connection** 26
- Digital Operator's Manual**
 - Help 22
 - Introduction 22
- Digital speedometer** 169
- DIRECT SELECT lever**
 - Automatic transmission 121
- Display messages**
 - ASSYST PLUS 243
 - Calling up (on-board computer) 178
 - Driving systems 194
 - Engine 191
 - General notes 177
 - Hiding (on-board computer) 177
 - Lights 189
 - Safety systems 179
 - SmartKey 202
 - Tires 198
 - Vehicle 199
- Distance display (on-board computer)** 173
- Distance Pilot DISTRONIC**
 - Activating 141
 - Calling up a speed 142
 - Cruise control lever 141
 - Display Message 196
 - Displays in the instrument cluster .. 144
 - Driving tips 146
 - Function/notes 140
 - Important safety notes 140
 - Setting a speed 143
 - Setting the specified minimum distance 143
 - Stopping 143
 - Storing a speed 142
 - Switching off 144
- Distance recorder** 168
- Distance warning (warning lamp)** 212
- Distance warning function**
 - Function/notes 58
 - Warning lamp 212
- Doors**
 - Automatic locking (on-board computer) 176
 - Automatic locking (switch) 71
 - Central locking/unlocking (SmartKey) 64
 - Control panel 35
 - Display message 201
 - Emergency locking 71
 - Emergency unlocking 71
 - Important safety notes 70
 - Opening (from inside) 70
- Drinking and driving** 132
- Drive program**
 - Automatic transmission 124
 - Display (DIRECT SELECT lever) 121
- Driver's door**
 - see Doors
- Driving abroad**
 - Mercedes-Benz Service 244
- Driving on flooded roads** 137
- Driving safety system**
 - Active Brake Assist 58
 - Braking assistance appropriate to the situation 59
- Driving safety systems**
 - ABS (Anti-lock Braking System) 57
 - ADAPTIVE BRAKE 62
 - BAS (Brake Assist System) 57
 - Distance warning function 58
 - EBD (electronic brake force distribution) 62
 - ESP® (Electronic Stability Program) 60
 - Important safety information 56
 - Overview 56
 - STEER CONTROL 62
- Driving system**
 - Distance Pilot DISTRONIC 140
 - DYNAMIC BODY CONTROL 148
 - Parking assist PARKTRONIC 148
 - Parking Pilot 151
 - Start-off assist 147
- Driving systems**
 - ATTENTION ASSIST 158
 - Blind Spot Assist 160
 - Cruise control 138
 - Display message 194
 - HOLD function 146
 - Lane Keeping Assist 162
 - Lane Tracking package 160

- Rear view camera 155
 - Driving tips**
 - Automatic transmission 123
 - Brakes 135
 - Break-in period 113
 - Checking brake lining thickness 136
 - Distance Pilot DISTRONIC 146
 - Downhill gradient 135
 - Drinking and driving 132
 - Driving in winter 137
 - Driving on flooded roads 137
 - Driving on wet roads 137
 - Exhaust check 132
 - Fuel 132
 - General 131
 - Hydroplaning 137
 - Icy road surfaces 137
 - Limited braking efficiency on salted roads 136
 - Snow chains 272
 - The first 1000 miles (1500 km) 113
 - Wet road surface 135
 - DVD video**
 - Operating (on-board computer) 171
 - see also Digital Operator's Manual 213
 - DYNAMIC SELECT button** 120
 - Climate control (3-zone automatic climate control) 107
 - Climate control (air-conditioning system) 105
- E**
- EASY-PACK tailgate**
 - see Tailgate
 - EASY-VARIO-PLUS system**
 - Cargo compartment enlargement .. 224
 - EBD (electronic brake force distribution)**
 - Display message 181
 - Function/notes 62
 - ECO display**
 - Function/notes 133
 - On-board computer 168
 - ECO start/stop function**
 - Automatic engine start 118
 - Automatic engine switch-off 118
 - Deactivating/activating 118
 - General information 118
 - Important safety notes 117
 - Introduction 117
 - Electronic Stability Program**
 - see ESP® (Electronic Stability Program)
 - Emergency**
 - Automatic measures after an accident 50
 - Emergency release**
 - Driver's door 71
 - Vehicle 71
 - Emergency spare wheel**
 - General notes 291
 - Important safety notes 291
 - Removing 291
 - Emergency Tensioning Devices**
 - Activation 49
 - Emissions control**
 - Service and warranty information 24
 - Engine**
 - Check Engine warning lamp 210
 - Display message 191
 - ECO start/stop function 117
 - Engine number 295
 - Irregular running 119
 - Jump-starting 260
 - Starting (important safety notes) ... 115
 - Starting problems 119
 - Starting the engine with the SmartKey 116
 - Starting with the Start/Stop button 116
 - Switching off 129
 - Tow-starting (vehicle) 266
 - Engine electronics**
 - Problem (malfunction) 119
 - Engine oil**
 - Adding 241
 - Additives 298
 - Checking the oil level 240
 - Checking the oil level using the dipstick 240
 - Display message 193
 - Filling capacity 298
 - Notes about oil grades 297
 - Notes on oil level/consumption 240

- Entering an address**
 see also Digital Operator's Manual 213
- ESP® (Electronic Stability Program)**
 Activating/deactivating (on-board computer) 173
 Characteristics 61
 Deactivating/activating (notes) 61
 Display message 179
 Function/notes 60
 General notes 60
 Important safety information 60
 Trailer stabilization 62
 Warning lamp 207
- ETS/4ETS (Electronic Traction System)** 60
- Exhaust**
 see Exhaust pipe
- Exhaust check** 132
- Exhaust pipe**
 Cleaning 248
- Exterior lighting**
 Cleaning 247
 see Lights
- Exterior mirrors**
 Adjusting 89
 Dipping (automatic) 90
 Folding in when locking (on-board computer) 176
 Folding in/out (automatically) 90
 Folding in/out (electrically) 89
 Out of position (troubleshooting) 90
 Setting 89
 Storing settings (memory function) 91
 Storing the parking position 90
- Eyeglasses compartment** 222
- F**
- Favorites**
 Overview 215
- Filler cap**
 see Refueling
- First-aid kit** 252
- Flat tire**
 MOExtended tires 254
 Preparing the vehicle 253
 TIREFIT kit 254
 see Emergency spare wheel
- Floormats** 237
- Folding table** 223
- Frequencies**
 Mobile phone 293
 Two-way radio 293
- Front-passenger seat**
 Folding the backrest forward/back 223
- Fuel**
 Additives 297
 Consumption statistics 168
 Displaying the current consumption 168
 Displaying the range 168
 Driving tips 132
 E10 296
 Fuel gauge 31
 Grade (gasoline) 296
 Important safety notes 296
 Problem (malfunction) 128
 Refueling 127
 Tank content/reserve fuel 296
- Fuel filler flap**
 Opening 127
- Fuel level**
 Calling up the range (on-board computer) 168
- Fuel tank**
 Capacity 296
 Problem (malfunction) 128
- Fuses**
 Allocation chart 267
 Before changing 266
 Fuse box in the engine compartment 267
 Fuse box in the front-passenger footwell 267
 Important safety notes 266
- G**
- Garage door opener**
 Clearing the memory 236
 General notes 233
 Important safety notes 234

| | |
|--|-----|
| Opening/closing the garage door .. | 236 |
| Problems when programming | 235 |
| Programming (button in the rear-view mirror) | 234 |
| Synchronizing the rolling code | 235 |
| Gasoline | 296 |
| Genuine parts | 23 |
| Glove box | 222 |
| Google™ Local Search | |
| see also Digital Operator's Manual | 213 |
| H | |
| Hazard warning lamps | |
| Display message | 202 |
| Switching on/off | 95 |
| Head restraints | |
| Adjusting | 85 |
| Adjusting (manually) | 86 |
| Adjusting (rear) | 86 |
| Headlamps | |
| Fogging up | 95 |
| see Automatic headlamp mode | |
| Heating | |
| see Climate control | |
| High beam flasher | 94 |
| High-beam headlamps | |
| Display message | 190 |
| Replacing bulbs | 98 |
| Switching on/off | 94 |
| Hill start assist | 117 |
| HOLD function | |
| Activating | 147 |
| Activation conditions | 147 |
| Deactivating | 147 |
| Display message | 194 |
| Function/notes | 146 |
| Home address | |
| see also Digital Operator's Manual | 213 |
| Hood | |
| Closing | 240 |
| Display message | 201 |
| Important safety notes | 239 |
| Opening | 239 |
| Horn | 30 |
| Hydroplaning | 137 |

I

| | |
|--|-----|
| Ignition lock | |
| see Key positions | |
| Immobilizer | 62 |
| Indicator lamps | |
| see Warning and indicator lamps | |
| Indicators | |
| see Turn signals | |
| Instrument cluster | |
| Overview | 31 |
| Settings | 175 |
| Warning and indicator lamps | 31 |
| Instrument cluster lighting | 164 |
| Interior lighting | |
| Control | 96 |
| Overview | 95 |
| Reading lamp | 95 |
| iPod® | |
| see also Digital Operator's Manual | 213 |

J

| | |
|-------------------------------------|-----|
| Jack | |
| Storage location | 252 |
| Using | 287 |
| Jump starting (engine) | 260 |

K

| | |
|-----------------------------------|-----|
| Key positions | |
| Start/Stop button | 114 |
| KEYLESS-GO | |
| Convenience closing feature | 76 |
| Deactivation | 64 |
| Locking | 64 |
| Unlocking | 64 |
| Kickdown | |
| Driving tips | 124 |
| Manual gearshifting | 126 |
| Knee bag | 43 |

L

| | |
|---------------------------------|--|
| Lamps | |
| see Warning and indicator lamps | |

- Lane Keeping Assist**
 - Activating/deactivating (on-board computer) 174
 - Display message 194
 - Function/information 162
 - Lane Tracking package** 160
 - LATCH-type (ISOFIX) child seat anchors** 53
 - License plate lamp**
 - Changing bulbs 100
 - License plate lamp (display message)** 190
 - Light sensor (display message)** 191
 - Lights**
 - Automatic headlamp mode 93
 - Fogged up headlamps 95
 - Hazard warning lamps 95
 - High beam flasher 94
 - High-beam headlamps 94
 - Light switch 93
 - Low-beam headlamps 94
 - Parking lamps 94
 - Rear fog lamp 94
 - Setting exterior lighting 93
 - Standing lamps 94
 - Switching the daytime running lamps on/off (on-board computer) 176
 - Turn signals 94
 - Loading guidelines** 221
 - Locking**
 - see Central locking
 - Locking (doors)**
 - Automatic 71
 - Emergency locking 71
 - From inside (central locking button) 70
 - Locking centrally**
 - see Central locking
 - Locking verification signal (on-board computer)** 176
 - Low-beam headlamps**
 - Display message 189
 - Replacing bulbs 97
 - Switching on/off 94
 - Lumbar support**
 - Adjusting the 4-way lumbar support 86
- M**
- M+S tires** 271
 - Malfunction message**
 - see Display messages
 - Matte finish (cleaning instructions)** 246
 - Mechanical key**
 - Function/notes 66
 - Inserting 66
 - Locking vehicle 71
 - Removing 66
 - Unlocking the driver's door 71
 - Memory card (audio)** 171
 - Memory function** 91
 - Message memory (on-board computer)** 178
 - Messages**
 - see Display messages
 - Mirror turn signal**
 - Cleaning 248
 - Mirrors**
 - see Exterior mirrors
 - see Rear-view mirror
 - see Vanity mirror (in the sun visor)
 - Mobile phone**
 - Connecting (Bluetooth® interface) 217
 - Connecting (device manager) 218
 - Frequencies 293
 - Installation 293
 - Menu (on-board computer) 171
 - Transmission output (maximum) 293
 - Modifying the programming (SmartKey)** 66
 - MOExtended tires** 254
 - Mounting wheels**
 - Lowering the vehicle 289
 - Mounting a new wheel 289
 - Preparing the vehicle 287
 - Raising the vehicle 287
 - Removing a wheel 289
 - Securing the vehicle against rolling away 287

- MP3**
 Operation 171
 see also Digital Operator's Manual 213
- Multifunction display**
 Function/notes 167
 Permanent display 175
- Multifunction steering wheel**
 Operating the on-board computer .. 165
 Overview 32
- Multimedia system**
 Switching on and off 214
- Music files**
 see also Digital Operator's Manual 213
- N**
- Navigation**
 Entering a destination 215
 Menu (on-board computer) 169
 see also Digital Operator's Manual 213
- Notes on breaking-in a new vehicle** 113
- O**
- Occupant Classification System (OCS)**
 Conditions 44
 Faults 48
 Operation 45
 System self-test 47
- Occupant safety**
 Air bags 42
 Automatic measures after an accident 50
 Belt warning 41
 Children in the vehicle 50
 Important safety notes 37
 Introduction to the restraint system 37
 Occupant Classification System (OCS) 44
 PASSENGER AIR BAG indicator lamps 38
 Pets in the vehicle 56
 Restraint system warning lamp 38
- Seat belt 38
- OCS**
 Conditions 44
 Faults 48
 Operation 45
 System self-test 47
- Odometer** 168
- On-board computer**
 Assistance graphic menu 173
 Assistance menu 172
 Audio menu 170
 Convenience submenu 176
 Display messages 177
 Displaying a service message 243
 Factory settings 177
 Important safety notes 164
 Instrument cluster submenu 175
 Lighting submenu 176
 Menu overview 167
 Message memory 178
 Navigation menu 169
 Operation 165
 Service menu 174
 Settings menu 175
 Standard display 168
 Telephone menu 171
 Trip menu 168
 Vehicle submenu 176
 Video DVD operation 171
- Operating safety**
 Declaration of conformity 26
 Important safety notes 25
- Operating system**
 see On-board computer
- Operation**
 Digital Operator's Manual 22
- Operator's Manual**
 Vehicle equipment 24
- Outside temperature display** 164
- Overhead control panel** 36
- Override feature**
 Rear side windows 56
- P**
- Paint code number** 294
- Paintwork (cleaning instructions)** ... 245
- Panic alarm** 37

- Panorama roof with power tilt/sliding panel**
- Important safety notes 79
 - Operating 80
 - Operating the roller sunblinds for the sliding sunroof 80
 - Problem (malfunction) 82
 - Reversing feature 79
- Parking**
- Important safety notes 129
 - Parking brake 130
 - Parking position for the exterior mirror on the front-passenger side 90
 - Rear view camera 155
- Parking aid**
- see Exterior mirrors
 - see Rear view camera
- Parking Assist PARKTRONIC**
- Deactivating/activating 150
 - Driving system 148
 - Function/notes 148
 - Important safety notes 148
 - Problems (malfunctions) 151
 - Sensor range 149
 - Warning display 150
- Parking assistance**
- see Parking Assist PARKTRONIC
- Parking brake**
- Applying automatically 131
 - Applying or releasing manually 130
 - Display message 181
 - Electric parking brake 130
 - Emergency braking 131
 - General notes 130
 - Releasing automatically 131
 - Warning lamp 209
- Parking lamps**
- Switching on/off 94
- Parking Pilot**
- Canceling 155
 - Detecting parking spaces 152
 - Display Message 195
 - Exiting a parking space 154
 - Function/notes 151
 - Important safety notes 151
 - Parking 153
- PASSENGER AIR BAG**
- Display message 187
 - Indicator lamps 38
 - Problem (malfunction) 187
- Pets in the vehicle** 56
- Phone book**
- see also Digital Operator's Manual 213
- Plastic trim (cleaning instructions)** 249
- Power washers** 245
- Power windows**
- see Side windows
- Protection against theft**
- ATA (Anti-Theft Alarm system) 63
 - Immobilizer 62
- Protection of the environment**
- General notes 23
- Pulling away**
- Automatic transmission 117
 - General notes 117
 - Hill start assist 117
- Q**
- QR code**
- Mercedes-Benz Guide App 1
 - Rescue card 27
- Qualified specialist workshop** 26
- R**
- Radio**
- Selecting a station 170
 - see Digital Operator's Manual
- Radio mode**
- see also Digital Operator's Manual 213
- Radio-wave reception/transmission in the vehicle**
- Declaration of conformity 26
- Rain closing feature (panorama roof with power tilt/sliding panel)** 80
- Reading lamp** 95
- Rear compartment**
- Setting the air vents 112
- Rear fog lamp**
- Display message 190

- Replacing bulbs 98
- Switching on/off 94
- Rear lamps**
- see Lights
- Rear seat**
- Adjusting the angle of the backrests 226
- Folding the backrest forwards/back (vehicles with the EASY-VARIO-PLUS system) 225
- Folding the backrest forwards/back (vehicles without the EASY-VARIO-PLUS system) 225
- Fore-and-aft adjustment 226
- Rear view camera**
- "Reverse parking" function 157
- Cleaning instructions 248
- Display in the multimedia system .. 156
- Function/notes 155
- General notes 155
- Switching on/off 156
- Rear window defroster**
- Problem (malfunction) 111
- Switching on/off 110
- Rear window wiper**
- Replacing the wiper blade 102
- Switching on/off 101
- Rear-view mirror**
- Anti-glare (manual) 88
- Dipping (automatic) 90
- Reflective safety jacket** 251
- Refrigerant (air-conditioning system)**
- Important safety notes 299
- Refueling**
- Fuel gauge 31
- Important safety notes 127
- Refueling process 127
- see Fuel
- Remote control**
- Garage door opener 233
- Programming (garage door opener) 234
- Replacing bulbs**
- Backup lamp 98
- High-beam headlamps 98
- Important safety notes 96
- Installing/removing the cover (front wheel arch) 97
- License plate lamp 100
- Low-beam headlamps 97
- Overview of bulb types 96
- Rear fog lamp 98
- Turn signals (front) 98
- Rescue card** 27
- Reserve (fuel tank)**
- see Fuel
- Reserve fuel**
- Display message 193
- Warning lamp 210
- see Fuel
- Residual heat (climate control)** 111
- Restraint system**
- Display message 185
- Introduction 37
- Warning lamp 209
- Warning lamp (function) 38
- Reversing feature**
- Roller sunblind 81
- Side windows 75
- Tailgate 72
- Roadside Assistance (breakdown)** 24
- Roller sunblind**
- Panorama roof with power tilt/sliding panel 80
- Roof carrier** 229
- Roof lining and carpets (cleaning guidelines)** 250
- Roof load (maximum)** 300
- Route guidance**
- see also Digital Operator's Manual 213

S

Safety

- Children in the vehicle 50
- see Occupant safety

Safety system

- see Driving safety systems

SD card

- Inserting 219
- Inserting/removing 219
- Removing 219

- SD memory card**
 - see also Digital Operator's Manual 213
- Search & Send**
 - see also Digital Operator's Manual 213
- Seat**
 - Correct driver's seat position 83
- Seat belts**
 - Adjusting the height 41
 - center rear-compartment seat 41
 - Cleaning 250
 - Correct usage 40
 - Fastening 41
 - Important safety guidelines 39
 - Introduction 38
 - Releasing 41
 - Warning lamp 204
 - Warning lamp (function) 41
- Seats**
 - Adjusting (electrically) 85
 - Adjusting (manually) 84
 - Adjusting the 4-way lumbar support 86
 - Adjusting the head restraint 85
 - Cleaning the cover 249
 - Folding the backrest (rear compartment) forwards/back (vehicles with the EASY-VARIO-PLUS system) 225
 - Folding the backrest (rear compartment) forwards/back (vehicles without the EASY-VARIO-PLUS system) 225
 - Important safety notes 83
 - Seat heating problem 87
 - Storing settings (memory function) 91
 - Switching seat heating on/off 87
- Section**
 - Cargo compartment 72
- Securing cargo** 227
- Selector lever**
 - Cleaning 249
- Sensors (cleaning instructions)** 248
- Service menu (on-board computer)** 174
- Service message**
 - see ASSYST PLUS
- Service products**
 - Brake fluid 298
 - Coolant (engine) 298
 - Engine oil 297
 - Fuel 295
 - Important safety notes 295
 - Refrigerant (air-conditioning system) 299
 - Washer fluid 299
- Setting the air distribution** 108
- Setting the airflow** 109
- Setting the date/time format**
 - see also Digital Operator's Manual 213
- Setting the language**
 - see also Digital Operator's Manual 213
- Setting the time**
 - see also Digital Operator's Manual 213
- Settings**
 - Factory (on-board computer) 177
 - On-board computer 175
- Side impact air bag** 43
- Side marker lamp (display message)** 190
- Side windows**
 - Cleaning 247
 - Convenience closing feature 76
 - Convenience opening feature 76
 - Important safety information 75
 - Opening/closing 75
 - Problem (malfunction) 78
 - Resetting 77
 - Reversing feature 75
- SIRIUS services**
 - see also Digital Operator's Manual 213
- Sliding sunroof**
 - see Panorama roof with power tilt/sliding panel
- SmartKey**
 - Changing the battery 67
 - Changing the programming 66
 - Checking the battery 67
 - Convenience closing feature 76

- Convenience opening feature 76
 - Display message 202
 - Door central locking/unlocking 64
 - Important safety notes 64
 - KEYLESS-GO start function 65
 - Loss 68
 - Mechanical key 66
 - Positions (ignition lock) 114
 - Problem (malfunction) 68
 - Starting the engine 116
 - SmartKey positions (ignition lock) ..** 114
 - SMS**
 - see also Digital Operator's Manual 213
 - Snow chains** 272
 - Sockets**
 - Center console 233
 - General notes 233
 - Luggage compartment 233
 - Rear compartment 233
 - Sound**
 - Switching on/off 214
 - Special seat belt retractor** 51
 - Specialist workshop** 26
 - Speed, controlling**
 - see Cruise control
 - Speedometer**
 - Activating/deactivating the additional speedometer 175
 - Digital 169
 - In the Instrument cluster 31
 - Segments 164
 - Selecting the display unit 175
 - Standing lamps**
 - Display message 190
 - Switching on/off 94
 - Start-off assist**
 - Activating 147
 - Important safety notes 147
 - Start/Stop button**
 - Removing 115
 - Starting the engine 116
 - Start/stop function**
 - see ECO start/stop function
 - Status overview (on-board computer)** 173
 - STEER CONTROL** 62
 - Steering**
 - Display message 201
 - Steering assistant STEER CONTROL**
 - see STEER CONTROL
 - Steering wheel**
 - Adjusting (manually) 88
 - Button overview 32
 - Buttons (on-board computer) 165
 - Cleaning 249
 - Important safety notes 88
 - Paddle shifters 125
 - Steering wheel paddle shifters** 125
 - Stowage compartments**
 - Armrest (front) 222
 - Armrest (under) 223
 - Center console 222
 - Center console (rear) 223
 - Cup holders 230
 - Eyeglasses compartment 222
 - Glove box 222
 - Important safety information 221
 - Map pockets 223
 - Stowage net 223
 - Stowage net** 223
 - Summer tires** 271
 - Sun visor** 231
 - Switching air-recirculation mode on/off** 111
 - Switching on media mode**
 - Via the device list 219
- T
- Tachometer** 164
 - Tail lamps**
 - Display message 190
 - see Lights
 - Tailgate**
 - Display message 201
 - Emergency unlocking 74
 - Important safety notes 72
 - Limiting the opening angle 74
 - Obstruction detection 72
 - Opening dimensions 300
 - Opening/closing (from outside) 73
 - Opening/closing automatically from inside 73

- Tank**
 - see Fuel tank
- Tank content**
 - Fuel gauge 31
- Technical data**
 - Capacities 295
 - Information 293
 - Tires/wheels 290
 - Vehicle data 300
- Telephone**
 - Accepting a call (multifunction steering wheel) 172
 - Authorizing a mobile phone (connecting) 217
 - Authorizing a mobile phone via the device manager (connecting) 218
 - Connecting a mobile phone (device manager) 218
 - Connecting a mobile phone (general information) 217
 - Display message 201
 - Introduction 171
 - Menu (on-board computer) 171
 - Number from the phone book 172
 - Redialing 172
 - Rejecting/ending a call 172
 - see also Digital Operator's Manual 213
- Temperature**
 - Coolant 165
 - Outside temperature 164
 - Setting (climate control) 108
- Through-loading feature** 224
- Tire pressure**
 - Checking manually 275
 - Display message 198
 - Maximum 275
 - Not reached (TIREFIT) 256
 - Notes 274
 - Reached (TIREFIT) 256
 - Recommended 272
- Tire pressure loss warning system**
 - General notes 275
 - Important safety notes 275
 - Restarting 276
- TIREFIT kit** 254
 - Important safety notes 254
 - Storage location 253
- Tire pressure not reached 256
- Tire pressure reached 256
- Tires**
 - Aspect ratio (definition) 285
 - Average weight of the vehicle occupants (definition) 284
 - Bar (definition) 284
 - Changing a wheel 286
 - Characteristics 284
 - Checking 269
 - Curb weight (definition) 285
 - Definition of terms 284
 - Direction of rotation 286
 - Display message 198
 - Distribution of the vehicle occupants (definition) 286
 - DOT (Department of Transportation) (definition) 284
 - DOT, Tire Identification Number (TIN) 283
 - GAWR (Gross Axle Weight Rating) (definition) 284
 - General notes 290
 - GVW (Gross Vehicle Weight) (definition) 285
 - GVWR (Gross Vehicle Weight Rating) (definition) 285
 - Important safety notes 269
 - Increased vehicle weight due to optional equipment (definition) 284
 - Information on driving 269
 - Kilopascal (kPa) (definition) 285
 - Labeling (overview) 281
 - Load bearing index (definition) 286
 - Load index 283
 - Load index (definition) 285
 - M+S tires 271
 - Maximum load on a tire (definition) 285
 - Maximum loaded vehicle weight (definition) 285
 - Maximum permissible tire pressure (definition) 285
 - Maximum tire load 283
 - Maximum tire load (definition) 285
 - MOExtended tires 271
 - Optional equipment weight (definition) 286

- PSI (pounds per square inch) (definition) 285
- Replacing 286
- Service life 270
- Sidewall (definition) 285
- Speed rating (definition) 285
- Storing 286
- Structure and characteristics (definition) 284
- Summer tires 271
- Temperature 280
- TIN (Tire Identification Number) (definition) 286
- Tire bead (definition) 285
- Tire pressure (definition) 285
- Tire pressures (recommended) 284
- Tire size (data) 290
- Tire size designation, load-bearing capacity, speed rating 281
- Tire tread 270
- Tire tread (definition) 285
- Total load limit (definition) 286
- Traction 280
- Traction (definition) 286
- Tread wear 280
- Uniform Tire Quality Grading Standards 279
- Uniform Tire Quality Grading Standards (definition) 284
- Wear indicator (definition) 286
- Wheel rim (definition) 284
- see Flat tire
- Top Tether** 53
- Tow-starting**
- Emergency engine starting 266
- Important safety notes 263
- Installing the towing eye 264
- Removing the towing eye 264
- Towing a trailer**
- ESP® (Electronic Stability Program) 62
- Towing away**
- Important safety guidelines 263
- Installing the towing eye 264
- Notes for 4MATIC vehicles 266
- Removing the towing eye 264
- Transporting the vehicle 265
- With both axles on the ground 265
- With the front axle raised 264
- Towing eye** 252
- Traffic reports**
- see also Digital Operator's Manual 213
- Transmission**
- see Automatic transmission
- Transmission position display (DIRECT SELECT lever)** 121
- Transporting the vehicle** 265
- Trim pieces (cleaning instructions)** 249
- Trip computer (on-board computer)** 168
- Trip odometer**
- Calling up 168
- Resetting (on-board computer) 169
- Trunk**
- Emergency release button 74
- Trunk lid**
- see Tailgate
- Turn signals**
- Display message 189
- Replacing bulbs (front) 98
- Switching on/off 94
- Two-way radio**
- Frequencies 293
- Installation 293
- Transmission output (maximum) 293
- Type identification plate**
- see Vehicle identification plate

U

Unlocking

- Emergency unlocking 71
- From inside the vehicle (central unlocking button) 70

USB devices

- Connecting to the Media Interface 220

V

Vanity mirror (in the sun visor) 232

Vehicle

- Correct use 27
- Data acquisition 27

- Display message 199
 - Equipment 24
 - Individual settings 175
 - Limited Warranty 27
 - Loading 276
 - Locking (in an emergency) 71
 - Locking (SmartKey) 64
 - Lowering 289
 - Maintenance 24
 - Parking for a long period 131
 - Pulling away 117
 - Raising 287
 - Reporting problems 27
 - Securing from rolling away 287
 - Transporting 265
 - Unlocking (in an emergency) 71
 - Unlocking (SmartKey) 64
 - Vehicle data 300
 - Vehicle data**
 - Roof load (maximum) 300
 - Trunk load (maximum) 300
 - Vehicle dimensions** 300
 - Vehicle emergency locking** 71
 - Vehicle identification number**
 - see VIN
 - Vehicle identification plate** 294
 - Vehicle tool kit** 252
 - Ventilation**
 - Setting the vents 112
 - Video**
 - Operating the DVD 171
 - see also Digital Operator's Manual 213
 - VIN**
 - Seat 295
 - Type plate 294
- W**
- Warning and indicator lamps**
 - ABS 206
 - Active Brake Assist 212
 - Brakes 205
 - Check Engine 210
 - Coolant 210
 - Distance warning 212
 - ESP® 207
 - ESP® OFF 208
 - Fuel tank 210
 - Overview 31
 - PASSENGER AIR BAG 38
 - Reserve fuel 210
 - Restraint system 209
 - Seat belt 204
 - Warning triangle** 252
 - Warranty** 24
 - Washer fluid**
 - Display message 201
 - Weather display (COMAND)**
 - see also Digital Operator's Manual 213
 - Wheel and tire combinations**
 - Tires 290
 - Wheel bolt tightening torque** 289
 - Wheel chock** 287
 - Wheels**
 - Changing a wheel 286
 - Checking 269
 - Cleaning 247
 - Emergency spare wheel 291
 - Important safety notes 269
 - Information on driving 269
 - Interchanging/changing 286
 - Mounting a new wheel 289
 - Removing a wheel 289
 - Storing 286
 - Tightening torque 289
 - Wheel size/tire size 290
 - Wheels and tires**
 - Changing a wheel 287
 - Window curtain air bag**
 - Display message 186
 - Operation 44
 - Windows**
 - see Side windows
 - Windshield**
 - Defrosting 109
 - Windshield washer system**
 - Adding washer fluid 242
 - Important safety notes 299
 - Windshield wipers**
 - Display message 202
 - Problem (malfunction) 103
 - Rear window wiper 101
 - Replacing the wiper blades 101
 - Switching on/off 100

Winter driving

- Slippery road surfaces 137
- Snow chains 272

Winter operation

- General notes 271

Winter tires

- M+S tires 271

Wiper blades

- Cleaning 247
- Important safety notes 101
- Replacing (rear window) 102

Wooden trim (cleaning instruc-

- tions) 249**

Workshop

- see Qualified specialist workshop

Z**ZONE function**

- Switching on/off 109

Introduction

The printed Operator's Manual provides information about the safe operation of your vehicle. The Digital Operator's Manual provides comprehensive and specifically adapted information on your vehicle's equipment and multimedia system. You can call up the Digital Operator's Manual via the multimedia system.

- i** You will not incur any costs when calling up the Digital Operator's Manual. The Digital Operator's Manual works without connecting to the Internet.

There are three ways to access the topics of the Digital Operator's Manual:

• Visual search

The visual search allows you to explore your vehicle "virtually". Starting from either the vehicle exterior view or interior view, you can access many of the different topics covered by the Digital Operator's Manual. To access the vehicle interior section, select the "Vehicle interior" view.

• Keyword search

The keyword search allows you to search for a keyword by entering characters.





• Contents

You can select individual sections in the contents.

- i** The Digital Operator's Manual is deactivated for safety reasons while driving.

Operation

Calling up the Digital Operator's Manual

- ▶ Press the  button in the center console. The overview relating to the vehicle appears.
- ▶ Select the "Operator's Manual" menu item by turning  or pressing  the controller.
- ▶ Confirm  the message about the warning and safety notes. The basic menu for the Digital Operator's Manual appears.

Operating the Digital Operator's Manual





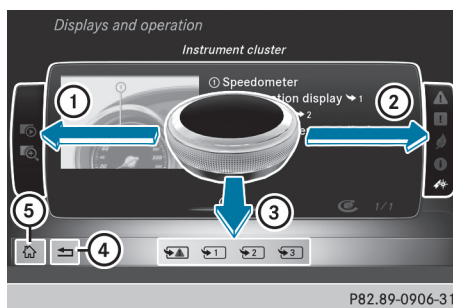

General notes

Please observe the information about the operation of the controller (▷ page 214).

Content pages

The content pages can be accessed by means of a visual search, a keyword search or using the contents.



- ▶ **To scroll forwards/backwards:** turn  the controller.
- ▶ **To display in full-screen or animation:** slide  the controller to the left **1**.
- ▶ **To select information texts or save bookmarks:** slide  the controller to the right **2**.
- ▶ **To select a link:** slide  the controller downwards **3**.
- ▶ **To exit a content page:** select  symbol **4**.
- ▶ **To call up the basic menu of the Digital Operator's Manual:** select  symbol **5**.
- ▶ **To switch functions to the multimedia system using the buttons on the center console:** press the **RADIO**, **TEL**, **MEDIA** or **NAVI** button. The selected menu appears. The Digital Operator's Manual remains open in the background.

Protecting the environment

General notes

Environmental note

Daimler's declared policy is one of comprehensive environmental protection.

The objectives are for the natural resources that form the basis of our existence on this planet to be used sparingly and in a manner that takes the requirements of both nature and humanity into account.

You too can help to protect the environment by operating your vehicle in an environmentally responsible manner.

Fuel consumption and the rate of engine, transmission, brake and tire wear are affected by these factors:

- operating conditions of your vehicle
- your personal driving style

You can influence both factors. You should bear the following in mind:

Operating conditions:

- avoid short trips as these increase fuel consumption.
- always make sure that the tire pressures are correct.
- do not carry any unnecessary weight.
- remove roof racks once you no longer need them.
- a regularly serviced vehicle will contribute to environmental protection. You should therefore adhere to the service intervals.
- always have service work carried out at a qualified specialist workshop.

Personal driving style:

- do not depress the accelerator pedal when starting the engine.
- do not warm up the engine when the vehicle is stationary.
- drive carefully and maintain a safe distance from the vehicle in front.
- avoid frequent, sudden acceleration and braking.

- change gear in good time and use each gear only up to $\frac{2}{3}$ of its maximum engine speed.
- switch off the engine in stationary traffic.
- keep an eye on the vehicle's fuel consumption.

Environmental concerns and recommendations

Wherever the Operator's Manual requires you to dispose of materials, first try to regenerate or reuse them. Observe the relevant environmental rules and regulations when disposing of materials. In this way you will help to protect the environment.

Genuine Mercedes-Benz parts

Environmental note

Daimler AG also supplies reconditioned major assemblies and parts which are of the same quality as new parts. They are covered by the same Limited Warranty entitlements as new parts.

! Air bags and Emergency Tensioning Devices, as well as control units and sensors for these restraint systems, may be installed in the following areas of your vehicle:

- doors
- door pillars
- door sills
- seats
- cockpit
- instrument cluster
- center console

Do not install accessories such as audio systems in these areas. Do not carry out repairs or welding. You could impair the operating efficiency of the restraint systems.

Have aftermarket accessories installed at a qualified specialist workshop.

You could jeopardize the operating safety of your vehicle if you use parts, tires and wheels as well as accessories relevant to safety which have not been approved by Mercedes-Benz. This could lead to malfunctions in safety-relevant

systems, e.g. the brake system. Use only genuine Mercedes-Benz parts or parts of equal quality. Only use tires, wheels and accessories that have been specifically approved for your vehicle.

Genuine Mercedes-Benz parts are subject to strict quality control. Every part has been specifically developed, manufactured or selected for and adapted to Mercedes-Benz vehicles. Therefore, only genuine Mercedes-Benz parts should be used.

More than 300,000 different genuine Mercedes-Benz parts are available for Mercedes-Benz models.

All authorized Mercedes-Benz Centers maintain a supply of genuine Mercedes-Benz parts for necessary service and repair work. In addition, strategically located parts delivery centers provide quick and reliable parts service.

Always specify the vehicle identification number (VIN) when ordering genuine Mercedes-Benz parts (> page 294).

Operator's Manual

Vehicle equipment

i This Operator's Manual describes all models and all standard and optional equipment of your vehicle available at the time of this Operator's Manual going to print. Country-specific differences are possible. Bear in mind that your vehicle may not feature all functions described here. This also applies to safety-relevant systems and functions. The equipment in your vehicle may therefore differ from that shown in the descriptions and illustrations.

The original purchase agreement lists all systems installed in your vehicle.

Should you have any questions concerning equipment and operation, please consult an authorized Mercedes-Benz Center.

The Operator's Manual and Maintenance Booklet are important documents and should be kept in the vehicle.

Service and vehicle operation

Warranty

The Limited Warranty for your vehicle applies in accordance with the warranty terms and conditions in the Service and Warranty Information booklet.

Your authorized Mercedes-Benz Center will replace and repair all factory-installed parts in accordance with the following warranty terms and conditions:

- New Vehicle Limited Warranty
- Emission System Warranty
- Emission Performance Warranty
- California, Connecticut, Maine, Massachusetts, New York, Pennsylvania, Rhode Island and Vermont Emission Control System Warranty
- State warranty enforcement laws (lemon laws)

Replacement parts and accessories are covered by the Mercedes-Benz Parts and Accessories warranties. These are available at any authorized Mercedes-Benz Center.

i Should you lose your Service and Warranty Information booklet, have an authorized Mercedes-Benz Center arrange for a replacement. The new Service and Warranty Information booklet will be posted to you.

Maintenance

Always bring the Maintenance Booklet with you when taking the vehicle to an authorized Mercedes-Benz Center. Your customer service advisor will enter every service into your Maintenance Booklet on your behalf.

Roadside Assistance

The Mercedes-Benz Roadside Assistance Program offers technical help in the event of a breakdown. Calls to the toll-free Roadside Assistance Hotline are answered by our agents 24 hours a day, 365 days a year.

1-800-FOR-MERCEDES (1-800-367-6372)
(USA)

1-800-387-0100 (Canada)

For additional information, refer to the Mercedes-Benz Roadside Assistance Program

brochure (USA) or the "Roadside Assistance" section in the Service and Warranty Booklet (Canada). You will find both in the vehicle document wallet.

Change of address or change of ownership

In the event of a change of address, please send us the "Notification of Address Change" in the Service and Warranty Booklet or simply call the Mercedes-Benz Customer Assistance Center (USA) at the hotline number 1-800-FOR-MERCEdes (1-800-367-6372) or Customer Service Center (Canada) at 1-800-387-0100. This will assist us in contacting you in a timely manner should the need arise. If you sell your Mercedes, please leave all literature in the vehicle so that it is available to the next owner.

If you have purchased a used car, please send us the "Notification of Used Car Purchase" in the Service and Warranty Booklet or simply call the Mercedes-Benz Customer Assistance Center (USA) at the hotline number 1-800-FOR-MERCEdes (1-800-367-6372) or Customer Service (Canada) at 1-800-387-0100.

Vehicle operation outside Canada

When you are abroad with your vehicle, observe the following points:

- Service facilities or replacement parts may not be readily available.
- Lead-free fuel for vehicles with a catalytic converter may not be available. Leaded fuel can cause damage to the catalytic converter.
- The fuel may have a considerably lower octane number. Unsuitable fuel can cause engine damage.

Some Mercedes-Benz models are available for delivery in Europe through our European Delivery Program. For details, consult an authorized Mercedes-Benz Center or write to one of the following addresses.

In the USA

Mercedes-Benz USA, LLC
European Delivery Department
One Mercedes Drive
Montvale, NJ 07645-0350

In Canada

Mercedes-Benz Canada, Inc.
European Delivery Department
98 Vanderhoof Avenue
Toronto, Ontario M4G 4C9

Operating safety

Important safety notes

WARNING

If you do not have the prescribed service/maintenance work or any required repairs carried out, this can result in malfunctions or system failures. There is a risk of an accident. Always have the prescribed service/maintenance work as well as any required repairs carried out at a qualified specialist workshop.

WARNING

Flammable material such as leaves, grass or twigs may ignite if they come into contact with hot parts of the exhaust system. There is a risk of fire.

When driving off road or on unpaved roads, check the vehicle's underside regularly. In particular, remove parts of plants or other flammable materials which have become trapped. In the case of damage, contact a qualified specialist workshop.

WARNING

Modifications to electronic components, their software as well as wiring can impair their function and/or the function of other networked components. In particular, systems relevant to safety could also be affected. As a result, these may no longer function as intended and/or jeopardize the operating safety of the vehicle. There is an increased risk of an accident and injury.

Never tamper with the wiring as well as electronic components or their software. You should have all work to electrical and electronic equipment carried out at a qualified specialist workshop.

- !** There is a risk of damage to the vehicle if:
- the vehicle becomes stuck, e.g. on a high curb or an unpaved road
 - you drive too fast over an obstacle, e.g. a curb, a speed bump or a pothole in the road
 - a heavy object strikes the underbody or parts of the chassis

In situations like this, the body, the underbody, chassis parts, wheels or tires could be damaged without the damage being visible. Components damaged in this way can unexpectedly fail or, in the case of an accident, no longer withstand the loads they are designed to.

If the underbody paneling is damaged, combustible materials such as leaves, grass or twigs can gather between the underbody and the underbody paneling. If these materials come in contact with hot parts of the exhaust system, they can catch fire.

In such situations, have the vehicle checked and repaired immediately at a qualified specialist workshop. If on continuing your journey you notice that driving safety is impaired, pull over and stop the vehicle immediately, paying attention to road and traffic conditions. In such cases, consult a qualified specialist workshop.

Declarations of conformity

USA: "The wireless devices of this vehicle comply with Part 15 of the FCC Rules. Operation is subject to the two following two conditions: 1) These devices may not cause harmful interference, and 2) These devices must accept any interference received, including interference that may cause undesired operation. Changes or modifications not expressly approved by the party responsible for compliance could void the user's authority to operate the equipment."

Canada: "The wireless devices of this vehicle comply with Industry Canada license-exempt RSS standard(s). Operation is subject to the following two conditions: (1) These devices may not cause interference, and (2) These devices must accept any interference, including interference that may cause undesired operation of the device."

Diagnostics connection

The diagnostics connection is only intended for the connection of diagnostic equipment at a qualified specialist workshop.

WARNING

If you connect equipment to a diagnostics connection in the vehicle, it may affect the operation of vehicle systems. As a result, the operating safety of the vehicle could be affected. There is a risk of an accident.

Only connect equipment to a diagnostics connection in the vehicle, which is approved for your vehicle by Mercedes-Benz.

WARNING

Objects in the driver's footwell can restrict the pedal travel or obstruct a depressed pedal. The operating and road safety of the vehicle is jeopardized. There is a risk of an accident.

Make sure that all objects in the vehicle are stowed correctly, and that they cannot enter the driver's footwell. Install the floor mats securely and as specified in order to ensure sufficient clearance for the pedals. Do not use loose floor mats and do not place floor mats on top of one another.

- !** If the engine is switched off and equipment on the diagnostics connection is used, the starter battery may discharge.

Connecting equipment to the diagnostics connection can lead to emissions monitoring information being reset, for example. This may lead to the vehicle failing to meet the requirements of the next emissions test during the main inspection.

Qualified specialist workshop

An authorized Mercedes-Benz Center is a qualified specialist workshop. It has the necessary specialist knowledge, tools and qualifications to correctly carry out the work required on your vehicle. This is especially the case for work relevant to safety.

Observe the notes in the Maintenance Booklet.

Always have the following work carried out at an authorized Mercedes-Benz Center:

- work relevant to safety
- service and maintenance work
- repair work
- alterations, installation work and modifications
- work on electronic components

Correct use

If you remove any warning stickers, you or others could fail to recognize certain dangers. Leave warning stickers in position.

Observe the following information when driving your vehicle:

- the safety notes in this manual
- technical data for the vehicle
- traffic rules and regulations
- laws and safety standards pertaining to motor vehicles

Problems with your vehicle

If you should experience a problem with your vehicle, particularly one that you believe may affect its safe operation, we urge you to contact an authorized Mercedes-Benz Center immediately to have the problem diagnosed and rectified. If the problem is not resolved to your satisfaction, please discuss the problem again with an authorized Mercedes-Benz Center or, if necessary, contact us at one of the following addresses.

In the USA

Customer Assistance Center
Mercedes-Benz USA, LLC
3 Mercedes Drive
Montvale, NJ 07645-0350

In Canada

Customer Relations Department
Mercedes-Benz Canada, Inc.
98 Vanderhoof Avenue
Toronto, Ontario M4G 4C9

Limited Warranty

- ! Observe the notes in this Operator's Manual regarding the correct operation of your vehicle and possible damage to the vehicle. Damage to the vehicle which is caused by violation of these notes is not covered by the Mercedes-Benz implied warranty or the new or used-vehicle warranty.

QR codes for the rescue card

The QR codes are secured in the fuel filler flap and on the opposite side on the B-pillar. In the event of an accident, rescue services can use the QR code to quickly find the appropriate rescue card for your vehicle. The current rescue card contains the most important information about your vehicle in a compact form, e.g. the routing of the electric cables.

You can find more information under www.mercedes-benz.de/qrcode.

Data stored in the vehicle

Data storage

A wide range of electronic components in your vehicle contain data memories.

These data memories temporarily or permanently store technical information about:

- the vehicle's operating state
- incidents
- malfunctions

In general, this technical information documents the state of a component, a module, a system or the surroundings.

These include, for example:

- operating conditions of system components, e.g. fluid levels
- the vehicle's status messages and those of its individual components, e.g. number of wheel revolutions/speed, deceleration in movement, lateral acceleration, accelerator pedal position
- malfunctions and defects in important system components, e.g. lights, brakes
- vehicle reactions and operating conditions in special driving situations, e.g. air bag deploy-

ment, intervention of stability control systems

This data is of an exclusively technical nature and can be used to:

- ambient conditions, e.g. outside temperature
- assist in recognizing and rectifying malfunctions and defects
- analyze vehicle functions, e.g. after an accident
- optimize vehicle functions

The data cannot be used to trace the vehicle's movements.

When your vehicle is serviced, technical information can be read from the event data memory and malfunction data memory.

Services include, for example:

- repair services
- service processes
- warranties
- quality assurance

The vehicle is read out by employees of the service network (including the manufacturer) using special diagnostic testers. More detailed information is obtained from it, if required.

After a malfunction has been rectified, the information is deleted from the malfunction memory or is continually overwritten.

When operating the vehicle, situations are conceivable in which this technical data, in connection with other information (if necessary, under consultation with an authorized expert), could be traced to a person.

Examples include:

- accident reports
- damage to the vehicle
- witness statements

Further additional functions that have been contractually agreed upon with the customer allow certain vehicle data to be conveyed by the vehicle as well. The additional functions include, for example, vehicle location in case of an emergency.

Event data recorders

This vehicle is equipped with an event data recorder (EDR). This vehicle is equipped with an event data recorder (EDR). The main purpose of an EDR is to record, in certain crash or near

crash-like situations, such as an air bag deployment or hitting a road obstacle, data that will assist in understanding how a vehicle's systems performed. The EDR is designed to record data related to vehicle dynamics and safety systems for a short period of time, typically 30 seconds or less.

The EDR in this vehicle is designed to record such data as:

- How various systems in your vehicle were operating
- Whether or not the driver and passenger safety belts were buckled/fastened
- How far (if at all) the driver was depressing the accelerator and/or brake pedal and
- How fast the vehicle was traveling.

These data can help provide a better understanding of the circumstances in which crashes and injuries occur. NOTE: EDR data are recorded by your vehicle only if a non-trivial crash situation occurs; no data are recorded by the EDR under normal driving conditions and no personal data (e.g. name, gender, age and crash location) are recorded. However, other parties, such as law enforcement could combine the EDR data with the type of personally identifying data routinely acquired during a crash investigation.

Access to the vehicle and/or the EDR is needed to read data that is recorded by an EDR, and special equipment is required. In addition to the vehicle manufacturer, other parties that have the special equipment, such as law enforcement, can read the information by accessing the vehicle or the EDR.

EDR data may be used in civil and criminal matters as a tool in accident reconstruction, accident claims and vehicle safety. Since the Crash Data Retrieval CDR tool that is used to extract data from the EDR is commercially available, Mercedes-Benz USA, LLC ("MBUSA") expressly disclaims any and all liability arising from the extraction of this information by unauthorized Mercedes-Benz personnel.

MBUSA will not share EDR data with others without the consent of the vehicle owners or, if the vehicle is leased, without the consent of the lessee. Exceptions to this representation include responses to subpoenas by law enforcement; by federal, state or local government; in connection with or arising out of litigation involving MBUSA or its subsidiaries and affiliates; or, as required by law.

Warning: The EDR is a component of the Restraint System Module. Tampering with, altering, modifying or removing the EDR component may result in a malfunction of the Restraint System Module and other systems.

State laws or regulations regarding EDRs that conflict with federal regulation are pre-empted. This means that in the event of such conflict, the federal regulation governs. As of February 2013, 13 states have enacted laws relating to EDRs.

Information on copyright

General information

Information on license for free and open-source software used in your vehicle and its electronic components is available on the following website:

<http://www.mercedes-benz.com/opensource>

Registered trademarks

- Bluetooth® is a registered trademark of Bluetooth SIG Inc.
- DTS™ is a registered trademark of DTS, Inc.
- Dolby® and MLP™ are registered trademarks of DOLBY Laboratories.
- BabySmart™, ESP® and PRE-SAFE® are registered trademarks of Daimler AG.
- HomeLink® is a registered trademark of Johnson Controls.
- iPod® and iTunes® are registered trademarks of Apple Inc.
- Logic7® is a registered trademark of Harman International Industries.
- Microsoft® and Windows media® are registered trademarks of Microsoft Corporation.
- SIRIUS® is a registered trademark of Sirius XM Radio Inc.
- HD Radio™ is a registered trademark of iBiquity Digital Corporation.
- Gracenote® is a registered trademark of Gracenote, Inc.
- ZAGAT Survey® and related brands are registered trademarks of Zagat Survey, LLC.

Cockpit

At a glance

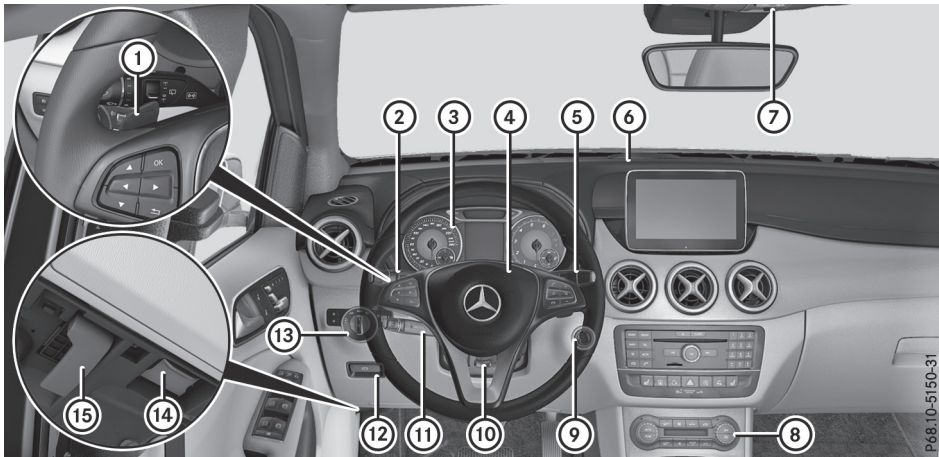

| | Function | Page |
|---|---|------|
| ① | Steering wheel paddle shifters | 125 |
| ② | Combination switch | 94 |
| ③ | Instrument cluster | 31 |
| ④ | Horn | |
| ⑤ | DIRECT SELECT lever | 121 |
| ⑥ | Parking Assist PARKTRONIC warning display | 150 |
| ⑦ | Overhead control panel | 36 |

| | Function | Page |
|---|----------------------------|------|
| ⑧ | Climate control systems | 104 |
| ⑨ | Ignition lock | 114 |
| ⑩ | Adjusts the steering wheel | 88 |
| ⑪ | Cruise control lever | 138 |
| ⑫ | Electric parking brake | 130 |
| ⑬ | Light switch | 93 |
| ⑭ | Diagnostics connection | 26 |
| ⑮ | Opens the hood | 239 |

Instrument cluster

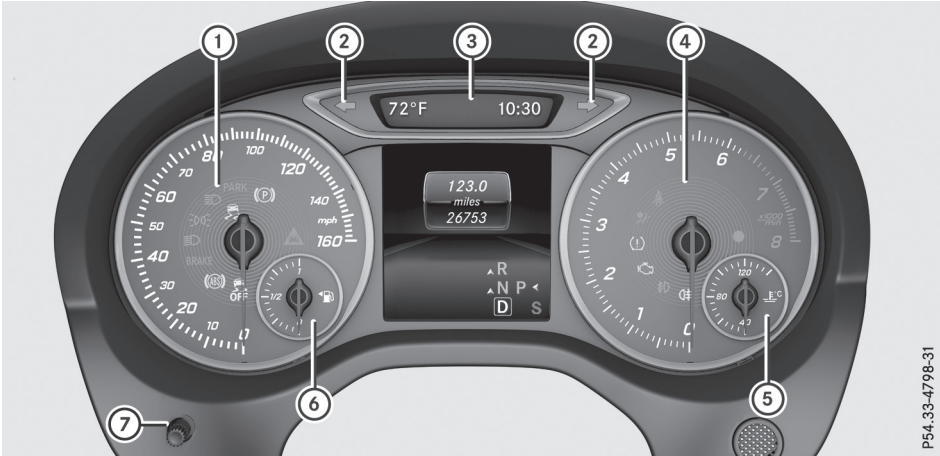

At a glance

P54.33-4798-31

| | Function | Page |
|---|---|------|
| ① | Speedometer with segments Warning and indicator lamps: | 164 |
| | Low-beam headlamps | 94 |
| | Parking lamps | 94 |
| | High-beam headlamps | 94 |
| | ESP® | 207 |
| | Electric parking brake applied (red) | |
| | (USA only) | |
| | (Canada only) | 209 |
| | Electric parking brake (yellow) | 209 |
| | Distance warning | 212 |
| | ESP® OFF | 207 |
| | ABS malfunctioning | 206 |
| | Braking | 205 |
| | (USA only) | |
| | (Canada only) | |

| | Function | Page |
|---|--|------|
| ② | Turn signals | 94 |
| ③ | Multifunction display | 167 |
| ④ | Tachometer | 164 |
| | Restraint system | 38 |
| | Seat belt not fastened | 204 |
| | Rear fog lamp | 94 |
| | Check Engine | 210 |
| ⑤ | Coolant temperature gage Warning and indicator lamps: | 165 |
| | Coolant too hot/cold | 210 |
| ⑥ | Fuel level indicator Warning and indicator lamps: | |
| | Reserve fuel | 210 |
| ⑦ | Instrument cluster lighting | 164 |

Multifunction steering wheel

At a glance

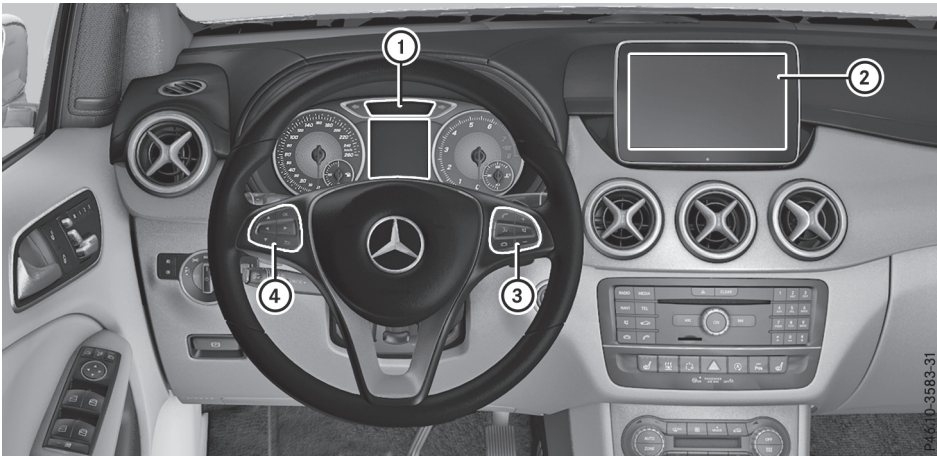

| | Function | Page |
|---|---|------|
| ① | Multifunction display | 167 |
| ② | Multimedia system display | |
| ③ | Rejects or ends a call Makes or accepts a call Further telephone functions Adjusts volume Mute Switches on voice-operated control for navigation or the Voice Control System | 171 |

| | Function | Page |
|---|---|------|
| ④ | Opens the menu list Selects a menu Confirms the selection Back Operates the on-board computer Switches off voice-operated control for navigation or the Voice Control System | 165 |

i In vehicles with multimedia system Audio 20 you can find further information:

- on the multimedia system in the Digital Operator's Manual
- on voice-controlled navigation in the manufacturer's operating instructions

i In vehicles with multimedia system COMAND you can find further information:





- on the multimedia system in the Digital Operator's Manual
- on the DVD changer or single DVD drive in the Digital Operator's Manual
- on the Voice Control System in the separate operating instructions

Center console

Center console, upper section



At a glance

| | Function | Page | | Function | Page |
|---|---|------|---|--|------|
| ① | Multimedia system; see the Digital Operator's Manual | | ⑤ |  Hazard warning lamps | 95 |
| ② |  Seat heating | 87 | ⑥ | PASSENGER AIRBAG indicator lamps | 38 |
| ③ |  Parking Assist PARKTRONIC | 150 | ⑦ | DYNAMIC SELECT button | 120 |
| ④ |  ECO start/stop function | 117 | | | |

Center console, lower section

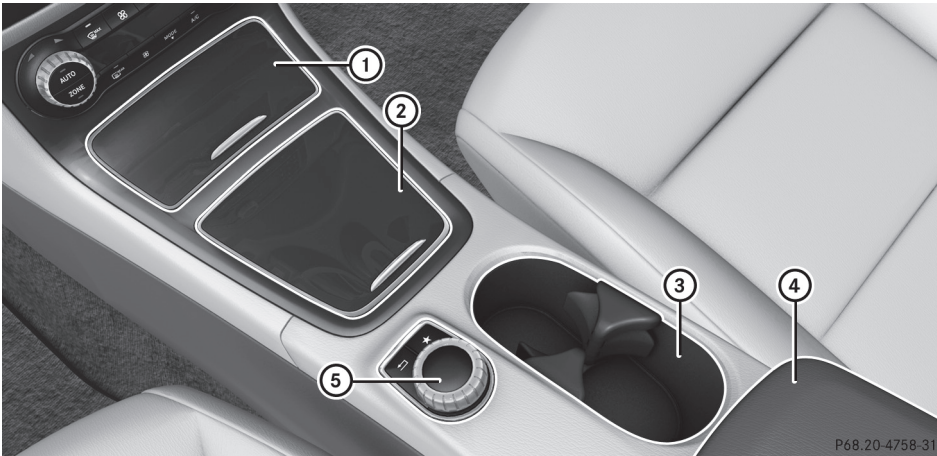

| | Function | Page |
|---|---|--------------------------|
| ① | Ashtray Cigarette lighter Socket Stowage compartment | 232 232 233 221 |
| ② | Stowage compartment | 221 |
| ③ | Cup holder | 230 |

| | Function | Page |
|---|---|------|
| ④ | Stowage compartment with Media Interface | 221 |
| ⑤ | Multimedia system controller; see Digital Operator's Manual | |

Door control panel

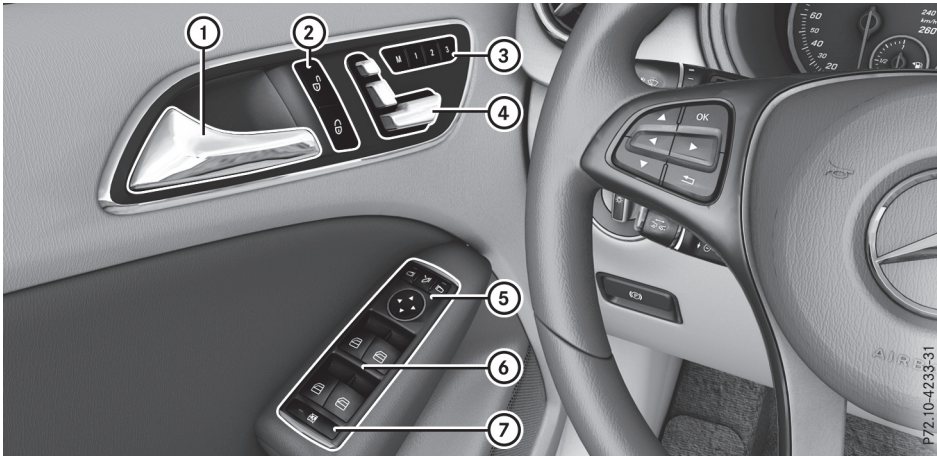

At a glance

| | Function | Page |
|---|--|------|
| ① | Opens the door | 70 |
| ② | Unlocks/locks the vehicle | 70 |
| ③ | Saves the seat and exterior mirror settings | 91 |
| ④ | Adjusts the seats electrically | 85 |
| ⑤ | Adjusts and folds the exterior mirrors in/out electrically | 89 |



| | Function | Page |
|---|---|------|
| ⑥ | Opens/closes the side windows | 75 |
| ⑦ | Activates/deactivates the override feature for the side windows in the rear compartment | 56 |

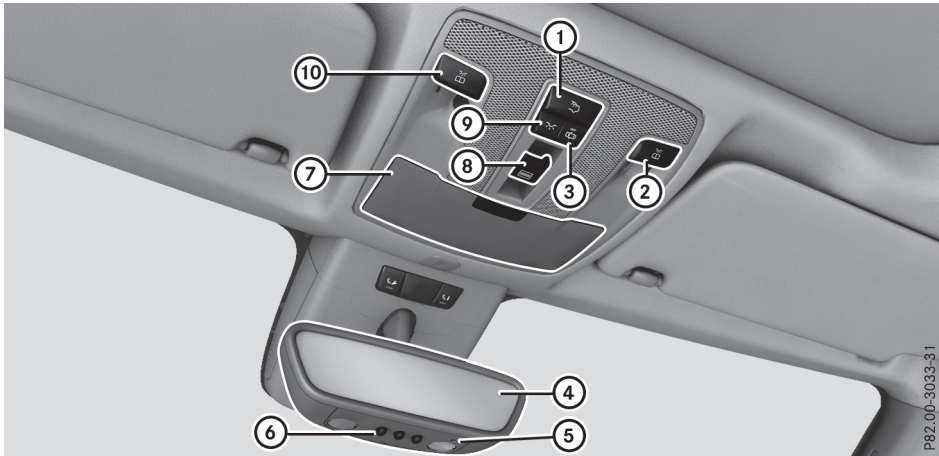

P72.10-4233-31

Overhead control panel

At a glance



| | Function | Page |
|---|--|------|
| ① |  Switches the rear compartment interior lighting on/off | 95 |
| ② |  Switches the right-hand reading lamp on/off | 95 |
| ③ |  Switches the front interior lighting/automatic interior lighting control off | 95 |
| ④ | Rear-view mirror | 90 |
| ⑤ | Sets the compass | 236 |
| ⑥ | Buttons for the garage door opener | 234 |

| | Function | Page |
|---|--|------|
| ⑦ | Eyeglasses compartment | 222 |
| ⑧ |  Opens/closes the panorama roof with power tilt/sliding panel with roller sunblinds | 80 |
| ⑨ |  Switches the front interior lighting on | 95 |
| ⑩ |  Switches the left-hand reading lamp on/off | 95 |

Panic alarm



P80.00-2224-31

- ▶ **To activate:** press and hold the **PANIC** button ① for approx. one second. A visual and audible alarm is triggered if the alarm system is armed.
- ▶ **To deactivate:** press **PANIC** button ① again.
or
- ▶ Insert the SmartKey into the ignition lock.
or, in vehicles with KEYLESS-GO start-function or KEYLESS-GO
- ▶ Press the Start/Stop button.
The SmartKey must be in the vehicle.

Occupant safety

Introduction to the restraint system

The restraint system can reduce the risk of vehicle occupants coming into contact with parts of the vehicle's interior in the event of an accident. The restraint system can also reduce the forces to which vehicle occupants are subjected during an accident.

The restraint system comprises:

- Seat belt system
- Air bags
- Child restraint system
- Child seat securing systems

The components of the restraint system work in conjunction with each other. They can only deploy their protective function if, at all times, all vehicle occupants:

- have fastened their seat belts correctly (▷ page 40)
- have the seat and head restraint adjusted properly (▷ page 83)

As the driver, you also have to make sure that the steering wheel is adjusted correctly. Observe the information relating to the correct driver's seat position (▷ page 83).

You also have to make sure that an air bag can inflate properly if deployed (▷ page 42).

An air bag supplements a correctly worn seat belt. As an additional safety device, the air bag increases the level of protection for vehicle occupants in the event of an accident. For example, if, in the event of an accident, the protection offered by the seat belt is sufficient, the air bags are not deployed. When an accident occurs, only the air bags that increase protection in that particular accident situation are deployed. However, seat belts and air bags generally do not protect against objects penetrating the vehicle from the outside.

Information on restraint system operation can be found under "Triggering of the Emergency Tensioning Devices and air bags" (▷ page 49).

See "Children in the vehicle" for information on children traveling with you in the vehicle as well as on child restraint systems (▷ page 50).

Important safety notes

WARNING

Modifications to the restraint system may cause it to no longer work as intended. The restraint system may then not perform its intended protective function and may fail in an accident or trigger unexpectedly, for example. This poses an increased risk of injury or even fatal injury.

Never modify parts of the restraint system. Never tamper with the wiring, the electronic components or their software.

If it is necessary to modify components of the restraint system to accommodate a person with disabilities, contact an authorized Mercedes-Benz Center for details. USA only: for further information contact our Customer Assistance Center at 1-800-FOR-MERCEDES (1-800-367-6372).

Mercedes-Benz recommends that you only use driving aids which have been approved specifically for your vehicle by Mercedes-Benz.

Restraint system warning lamp

The functions of the restraint system are checked after the ignition is switched on and at regular intervals while the engine is running. Therefore, malfunctions can be detected in good time.

The  restraint system warning lamp on the instrument cluster lights up when the ignition is switched on. It goes out no later than a few seconds after the vehicle is started. The components of the restraint system are in operational readiness.

A malfunction has occurred if the  restraint system warning lamp:

- does not light up after the ignition is switched on
- does not go out after a few seconds with the engine running
- lights up again while the engine is running



WARNING

If the restraint system is malfunctioning, restraint system components may be triggered unintentionally or may not deploy as intended during an accident. This can affect for example the Emergency Tensioning Device or the air bag. This poses an increased risk of injury or even fatal injury.

Have the restraint system checked and repaired in a qualified specialist workshop as soon as possible.

PASSENGER AIR BAG indicator lamp



PASSENGER AIR BAG ON indicator lamp  and PASSENGER AIR BAG OFF indicator lamp  are part of the Occupant Classification System (OCS).

The indicator lamps display the status of the front-passenger front air bag.

- PASSENGER AIR BAG ON lights up for 60 seconds, subsequently both indicator lamps are off (PASSENGER AIR BAG ON and OFF): the front-passenger front air bag is able to deploy in the event of an accident.
- PASSENGER AIR BAG OFF lights up: the front-passenger front air bag is deactivated. It will then not be deployed in the event of an accident.

If the PASSENGER AIR BAG ON indicator lamp is off, only the PASSENGER AIR BAG OFF indicator lamp shows the status of the front-passenger front air bag. The PASSENGER AIR BAG OFF indicator lamp may be lit continuously or be off. Depending on the person in the front-passenger seat, the front-passenger front air bag must either be deactivated or enabled; see the following points. You must make sure of this both before and during a journey.

• Children in a child restraint system:

whether the front-passenger front air bag is enabled or deactivated depends on the installed child restraint system, and the age and size of the child. Therefore, be sure to observe the notes on the "Occupant Classification System (OCS)" (▷ page 44) and on "Children in the vehicle" (▷ page 50). There you will also find instructions on rearward and forward-facing child restraint systems on the front-passenger seat.

- **All other persons:** depending on the classification of the person in the front-passenger seat, the front-passenger front air bag is enabled or deactivated (▷ page 44). Be sure to observe the notes on "Seat belts" (▷ page 38) and "Air bags" (▷ page 42). There you can also find information on the correct seat position.

Seat belts

Introduction

Seat belts are the most effective means of restricting the movement of vehicle occupants in the event of an accident or the vehicle rolling over. This reduces the risk of vehicle occupants coming into contact with parts of the vehicle interior or being ejected from the vehicle. Furthermore, the seat belt helps to keep the vehicle

occupant in the best position in relation to the air bag.

The seat belt system comprises:

- Seat belts
- Emergency Tensioning Devices for the front seat belts and the outer seat belts in the rear
- Seat belt force limiters for the front seat belts and the outer seat belts in the rear

If the seat belt is pulled out of the belt outlet quickly or with a jerky movement, the belt retractor locks. The belt strap cannot be extracted any further.

The Emergency Tensioning Device tightens the seat belt in an accident, pulling the belt close against the body. However it does not pull the vehicle occupant back in the direction of the backrest.

The Emergency Tensioning Device does not correct an incorrect seat position or the routing of an incorrectly fastened seat belt.

When triggered, a seat belt force limiter helps to reduce the force exerted by the seat belt on the vehicle occupant.

The seat belt force limiters for the front seats are synchronized with the front air bags, which absorb part of the deceleration force. This can reduce the force exerted on the vehicle occupants during an accident.

! If the front-passenger seat is not occupied, do not engage the seat belt tongue in the buckle on the front-passenger seat. Otherwise, in the event of an accident the Emergency Tensioning Device and the side impact air bag, in addition to other systems, may be triggered and have to be replaced.

Important safety notes

The use of seat belts and child restraint systems is required by law in:

- all 50 states
- the U.S. territories
- the District of Columbia
- all Canadian provinces

Even where this is not required by law, all vehicle occupants should correctly fasten their seat belts before starting the journey.

WARNING

If the seat belt is not worn correctly, it cannot perform its intended protective function. An

incorrectly fastened seat belt can also cause injuries, for example, in the event of an accident or when braking or changing direction abruptly. This poses an increased risk of injury or even fatal injury.

Always ensure that all vehicle occupants have their seat belts fastened correctly and are sitting properly.

The components of the restraint system work in conjunction with each other. They can only deploy their protective function if, at all times, all vehicle occupants:

- have fastened their seat belts correctly (▷ page 40)
- have the seat and head restraint adjusted properly (▷ page 83)

WARNING

The seat belt does not offer the intended level of protection if you have not moved the backrest to an almost vertical position. When braking or in the event of an accident, you could slide underneath the seat belt and sustain abdomen or neck injuries, for example. This poses an increased risk of injury or even fatal injury.

Adjust the seat properly before beginning your journey. Always ensure that the backrest is in an almost vertical position and that the shoulder section of your seat belt is routed across the center of your shoulder.

WARNING

Persons less than 5 ft (1.50 m) tall cannot wear the seat belt correctly without an additional and suitable restraint system. If the seat belt is not worn correctly, it cannot perform its intended protective function. An incorrectly fastened seat belt can also cause injuries, for example, in the event of an accident or when braking or changing direction abruptly. This poses an increased risk of injury or even fatal injury.

For this reason, always secure persons under 5 ft (1.50 m) tall in suitable additional restraint systems.

If a child younger than twelve years old and under 5 ft (1.50 m) in height is traveling in the vehicle:

- always secure the child in a child restraint system suitable for this Mercedes-Benz vehicle. The child restraint system must be appropriate to the age, weight and size of the child.
- always observe the instructions and safety notes on "Children in the vehicle" (> page 50) in addition to the child restraint system manufacturer's installation and operating instructions
- always observe the instructions and safety notes on the "Occupant classification system (OCS)" (> page 44)

WARNING

The seat belts may not perform their intended protective function if:

- they are damaged, modified, extremely dirty, bleached or dyed
- the seat belt buckle is damaged or extremely dirty
- the Emergency Tensioning Devices, belt anchorages or inertia reels have been modified.

Seat belts may be damaged in an accident, although the damage may not be visible, e.g. due to splinters of glass. Modified or damaged seat belts may tear or fail, e.g. in an accident. Modified Emergency Tensioning Devices could accidentally trigger or fail to deploy when necessary. This poses an increased risk of injury or even fatal injury.

Never modify the seat belts, Emergency Tensioning Devices, belt anchorages and inertia reels. Make sure that the seat belts are undamaged, not worn out and clean. Following an accident, have the seat belts checked immediately at a qualified specialist workshop.

Only use seat belts that have been approved for your vehicle by Mercedes-Benz.

Proper use of the seat belts

Observe the safety notes on the seat belt (> page 39).

All vehicle occupants must be wearing the seat belt correctly before beginning the journey. Also make sure that all vehicle occupants are always wearing the seat belt correctly while the vehicle is in motion.

When fastening the seat belt, always make sure that:

- the seat belt buckle tongue is inserted only into the belt buckle belonging to that seat
- the seat belt is pulled tight across your body. Avoid wearing bulky clothing, e.g. a winter coat.
- the seat belt is not twisted
Only then can the forces which occur be distributed over the area of the belt.
- the shoulder section of the belt is routed across the center of your shoulder
The shoulder section of the seat belt should not touch your neck or be routed under your arm or behind your back. Where possible, adjust the seat belt to the appropriate height.
- the lap belt is taut and passes across your lap as low down as possible

The lap belt must always be routed across your hip joints and not across your abdomen. This applies particularly to pregnant women. If necessary, push the lap belt down to your hip joint and pull it tight using the shoulder section of the belt.

- the seat belt is not routed across sharp, pointed or fragile objects
If you have such items located on or in your clothing, e.g. pens, keys or eyeglasses, store these in a suitable place.
- only one person is using a seat belt
Infants and children must never travel sitting on the lap of a vehicle occupant. In the event of an accident, they could be crushed between the vehicle occupant and seat belt.
- objects are never secured with a seat belt if the seat belt is also being used by one of the vehicle's occupants

Also ensure that there are never objects between a person and the seat, e.g. cushions.

Seat belts are only intended to secure and restrain vehicle occupants. Always observe the "Loading guidelines" for securing objects, luggage or loads (> page 221).

Fastening and adjusting the seat belts

Observe the safety notes on the seat belt (> page 39) and the notes on correct use of seat belts (> page 40).

If the center rear seat belt is being used, also observe the information about the seat belt for the center rear seat (> page 41).

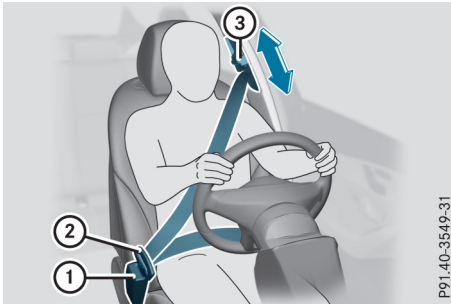

Basic illustration

- ▶ Adjust the seat (> page 83). The seat backrest must be in an almost upright position.
- ▶ Pull the seat belt smoothly from the belt outlet.
- ▶ Engage seat belt tongue ② in belt buckle ①.
- ▶ If necessary, pull up on the shoulder section of the seat belt to tighten the belt across your body.

The shoulder section of the seat belt must always be routed across the center of the shoulder. Adjust the belt outlet if necessary.

- ▶ **To raise:** slide the belt outlet up. The belt outlet will engage in various positions.
- ▶ **To lower:** hold belt outlet release ③ and slide the belt outlet down.
- ▶ Let go of belt outlet release ③ in the desired position and make sure that the belt outlet engages.

All seat belts except the driver's seat belt are equipped with a special seat belt retractor to securely fasten child restraint systems in the vehicle. Further information can be found under "Special seat belt retractor" (> page 51).

Seat belt for the center rear seat

If the left-hand rear seat backrest is folded down and back up again, the rear center seat belt may lock. The seat belt can then not be pulled out.

- ▶ **To release the rear center seat belt:** pull the seat belt out approximately 1 in (25 mm) at the belt outlet on the backrest and then release it again. The seat belt is retracted and released.



Releasing seat belts

! Make sure that the seat belt is fully rolled up. Otherwise, the seat belt or belt tongue will be trapped in the door or in the seat mechanism. This could damage the door, the door trim panel and the seat belt. Damaged seat belts can no longer fulfill their protective function and must be replaced. Visit a qualified specialist workshop.

- ▶ Press the release button in the belt buckle, hold the belt tongue firmly and guide the belt back.

Belt warning for the driver and front passenger

The  seat belt warning lamp in the instrument cluster is a reminder that all vehicle occupants must wear their seat belts. It may light up continuously or flash. In addition, there may be a warning tone.

Regardless of whether the driver's seat belt has already been fastened, the  seat belt warning lamp lights up for six seconds each time the engine is started. If the front doors are closed and the driver's or front-passenger seat belt has not been fastened, the  seat belt warning lamp lights up again after the six seconds. As soon as the driver's and front-passenger seat belts are fastened or a front door is opened again, the  seat belt warning lamp goes out. If the driver's seat belt is not fastened after the engine is started, an additional warning tone will sound. The warning tone switches off after six seconds or once the driver's seat belt is fastened.

If the vehicle's speed exceeds 15 mph (25 km/h) once and the driver's and front-passenger seat belts are not fastened, a warning tone sounds. A warning tone also sounds with increasing intensity for 60 seconds or until the driver or front passenger have fastened their seat belts.

If the driver or front passenger unfasten their seat belts during the journey, the seat belt warning is activated again.

Air bags

Introduction

The installation point of an air bag can be recognized by the AIRBAG marking.

An air bag complements the correctly fastened seat belt. It is no substitute for the seat belt. The air bag provides additional protection in applicable accident situations.

Not all air bags are deployed in an accident. The different air bag systems function independently from one another (▷ page 49).

However, no system available today can completely eliminate injuries and fatalities.

It is also not possible to rule out a risk of injury caused by an air bag due to the high speed at which the air bag must be deployed.

Important safety notes

WARNING

If you do not sit in the correct seat position, the air bag cannot protect as intended and could even cause additional injury when deployed. This poses an increased risk of injury or even fatal injury.

To avoid hazardous situations, always make sure that all of the vehicle's occupants:

- have fastened their seat belts correctly, including pregnant women
- are sitting correctly and maintain the greatest possible distance to the air bags
- follow the following instructions

Always make sure that there are no objects between the air bag and the vehicle's occupants.

- Adjust the seats properly before beginning your journey. Always make sure that the seat is in an almost upright position. The center of the head restraint must support the head at about eye level.
- Move the driver's and front-passenger seats as far back as possible. The driver's seat position must allow the vehicle to be driven safely.
- Only hold the steering wheel on the outside. This allows the air bag to be fully deployed.
- Always lean against the backrest while driving. Do not lean forward or lean against the

door or side window. You may otherwise be in the deployment area of the air bags.

- Always keep your feet in the footwell in front of the seat. Do not put your feet on the dashboard, for example. Your feet may otherwise be in the deployment area of the air bag.
- For this reason, always secure persons less than 5 ft (1.50 m) tall in suitable restraint systems. Up to this height, the seat belt cannot be worn correctly.

If a child is traveling in your vehicle, also observe the following notes:

- Always secure children under twelve years of age and less than 5 ft (1.50 m) tall in suitable child restraint systems.
- Child restraint systems should be installed on the rear seats.
- Only secure a child in a rearward-facing child restraint system on the front-passenger seat when the front-passenger front air bag is deactivated. If the PASSENGER AIR BAG OFF indicator lamp is permanently lit, the front-passenger front air bag is deactivated (▷ page 38).
- Always observe the instructions and safety notes on the "Occupant Classification System (OCS)" (▷ page 44) and on "Children in the vehicle" (▷ page 50) in addition to the child restraint system manufacturer's installation and operating instructions.

Objects in the vehicle interior may prevent an air bag from functioning correctly. Before starting your journey and to avoid risks resulting from the speed of the air bag as it deploys, make sure that:

- there are no people, animals or objects between the vehicle occupants and an air bag
- there are no objects between the seat, door and B-pillar
- there are no hard objects, e.g. coat hangers, hanging on the grab handles or coat hooks
- no accessories, such as cup holders, are attached to the vehicle within the deployment area of an air bag, e.g. to doors, side windows, rear side trim or side walls
- no heavy, sharp-edged or fragile objects are in the pockets of your clothing. Store such objects in a suitable place

WARNING

If you modify the air bag cover or affix objects such as stickers to it, the air bag can no longer

function correctly. There is an increased risk of injury.

Never modify an air bag cover or affix objects to it.

WARNING

Sensors to control the air bags are located in the doors. Modifications or work not performed correctly to the doors or door paneling, as well as damaged doors, can lead to the function of the sensors being impaired. The air bags might therefore not function properly anymore. Consequently, the air bags cannot protect vehicle occupants as they are designed to do. There is an increased risk of injury.

Never modify the doors or parts of the doors. Always have work on the doors or door paneling carried out at a qualified specialist workshop.

Front air bags

! Do not place heavy objects on the front-passenger seat. This could cause the system to identify the seat as being occupied. In the event of an accident, the restraint systems on the front-passenger side may be triggered and have to be replaced.

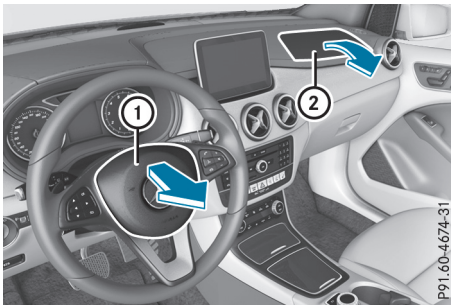

Driver's air bag ① deploys in front of the steering wheel. Front-passenger front air bag ② deploys in front of and above the glove box.

When deployed, the front air bags offer additional head and thorax protection for the occupants in the front seats.

The PASSENGER AIR BAG OFF indicator lamp informs you about the status of the front-passenger front air bag (> page 38).

The front-passenger front air bag will only deploy if:

- the system, based on the OCS weight sensor readings, detects that the front-passenger seat is occupied (> page 44). The PASSENGER AIR BAG OFF indicator lamp is not lit (> page 45)
- the restraint system control unit predicts a high accident severity

Driver's knee bag

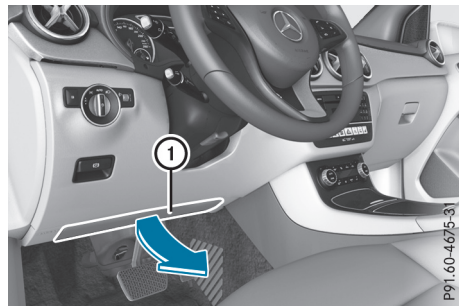

Driver's knee bag ① deploys under the steering column. The driver's knee bag is deployed together with the front air bag.

The driver's knee bag offers additional thigh, knee and lower leg protection for the occupant in the driver's seat.

Side impact air bags

WARNING

Unsuitable seat covers can obstruct or prevent deployment of the air bags integrated into the seats. Consequently, the air bags cannot protect vehicle occupants as they are designed to do. In addition, the operation of the occupant classification system (OCS) could be adversely affected. This poses an increased risk of injury or even fatal injury.

You should only use seat covers that have been approved for the respective seat by Mercedes-Benz.

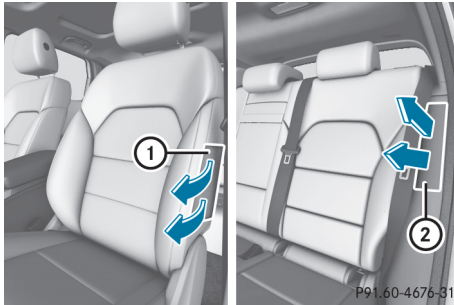

Front side impact air bags ① and rear side impact air bags ② deploy next to the outer bolster of the seat backrest.

When deployed, the side impact air bag offers additional thorax protection. It also offers additional pelvis protection for occupants in the front seats. However, it does not protect the:

- Head
- Neck
- Arms

If the restraint system control unit detects a side impact, the side impact air bag is deployed on the side on which the impact occurs.

The side impact air bag on the front-passenger side deploys under the following conditions:

- the OCS system detects that the front-passenger seat is occupied or
- the seat belt buckle tongue is engaged in the belt buckle of the front-passenger seat

If the belt tongue is engaged in the belt buckle, the side impact air bag on the front-passenger side deploys if an appropriate accident situation occurs. In this case, deployment is independent of whether the front-passenger seat is occupied or not.

Window curtain air bags

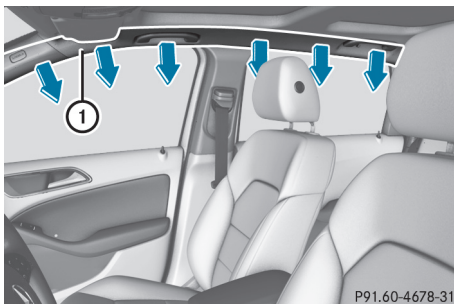

Window curtain air bags ① are integrated into the side of the roof frame and deployed in the area from the A-pillar to the C-pillar.

When deployed, the window curtain air bag enhances the level of protection for the head. However, it does not protect the chest or arms.

If the restraint system control unit detects a side impact, the window curtain air bag is deployed on the side on which the impact occurs.

If the system determines that they can offer additional protection to that provided by the seat belt, a window curtain air bag may be deployed in other accident situations (▷ page 49).

Occupant Classification System (OCS)

Introduction

The Occupant Classification System (OCS) categorizes the person in the front-passenger seat. Depending on that result, the front-passenger front air bag is either enabled or deactivated.

The system does not deactivate:

- the side impact air bag
- the window curtain air bag
- the Emergency Tensioning Devices

Requirements

To be classified correctly, the front passenger must sit:

- with the seat belt fastened correctly
- in an almost upright position with their back against the seat backrest
- with their feet resting on the floor, if possible

If the front passenger does not observe these conditions, OCS may produce a false classification, e.g. because the front passenger:

- transfers their weight by supporting themselves on a vehicle armrest
- sits in such a way that their weight is raised from the seat cushion

If it is absolutely necessary to install a child restraint system on the front-passenger seat, be sure to observe the correct positioning of the child restraint system. Never place objects under or behind the child restraint system, e.g. a cushion. The entire base of the child restraint system must always rest on the seat cushion of

the front-passenger seat. The backrest of the forward-facing child restraint system must lie as flat as possible against the backrest of the front-passenger seat.

The child restraint system must not touch the roof or be subjected to a load by the head restraint. Adjust the angle of the seat backrest and the head restraint position accordingly.

Only then can OCS be guaranteed to function correctly. Always observe the child restraint system manufacturer's installation and operating instructions.

Operation of Occupant Classification System (OCS)



- ① PASSENGER AIR BAG ON indicator lamp
- ② PASSENGER AIR BAG OFF indicator lamp

The indicator lamps inform you whether the front-passenger front air bag is deactivated or enabled.

- ▶ Press the Start/Stop button once or twice, or turn the SmartKey to position **1** or **2** in the ignition lock.

The system carries out self-diagnostics.

The PASSENGER AIR BAG OFF and PASSENGER AIR BAG ON indicator lamps must light up simultaneously for approximately six seconds.

The indicator lamps display the status of the front-passenger front air bag.

- PASSENGER AIR BAG ON lights up for 60 seconds, subsequently both indicator lamps are off (PASSENGER AIR BAG ON and OFF): the front-passenger front air bag is able to deploy in the event of an accident.
- PASSENGER AIR BAG OFF lights up: the front-passenger front air bag is deactivated. It will then not be deployed in the event of an accident.

If the PASSENGER AIR BAG ON indicator lamp is off, only the PASSENGER AIR BAG OFF indicator lamp shows the status of the front-passenger front air bag. The PASSENGER AIR BAG OFF indicator lamp may be lit continuously or be off.

If the status of the front-passenger front air bag changes while the vehicle is in motion, an air bag display message appears in the instrument cluster (▷ page 187). When the front-passenger seat is occupied, always pay attention to the PASSENGER AIR BAG OFF indicator lamp. Be aware of the status of the front-passenger front air bag both before and during the journey.

WARNING

If the PASSENGER AIR BAG OFF indicator lamp is lit, the front-passenger front air bag is disabled. It will not be deployed in the event of an accident and cannot perform its intended protective function. A person in the front-passenger seat could then, for example, come into contact with the vehicle's interior, especially if the person is sitting too close to the dashboard. This poses an increased risk of injury or even fatal injury.

When the front-passenger seat is occupied, always ensure that:

- the classification of the person in the front-passenger seat is correct and the front-passenger front air bag is enabled or disabled in accordance with the person in the front-passenger seat
- the front-passenger seat has been moved back as far back as possible.
- the person is seated correctly.

Make sure, both before and during the journey, that the status of the front-passenger front air bag is correct.

WARNING

If you secure a child in a rearward-facing child restraint system on the front-passenger seat and the PASSENGER AIR BAG OFF indicator lamp is off, the front-passenger front air bag can deploy in the event of an accident. The child could be struck by the air bag. This poses an increased risk of injury or even fatal injury.

Make sure that the front-passenger front air bag has been deactivated. The PASSENGER AIR BAG OFF indicator lamp must be lit.

NEVER use a rearward-facing child restraint on a seat protected by an ACTIVE FRONT AIR-BAG in front of it; DEATH or SERIOUS INJURY to the child can occur.

If the PASSENGER AIR BAG OFF indicator lamp stays off, do not install a rearward-facing child restraint system on the front-passenger seat. You can find more information on OCS under "Problems with the Occupant Classification System" (▷ page 48).

WARNING

If you secure a child in a forward-facing child restraint system on the front-passenger seat and you position the front-passenger seat too close to the dashboard, in the event of an accident, the child could:

- come into contact with the vehicle's interior if the PASSENGER AIR BAG OFF indicator lamp is lit, for example
- be struck by the air bag if the PASSENGER AIR BAG OFF indicator lamp is off

This poses an increased risk of injury or even fatal injury.

Always move the front-passenger seat as far back as possible and fully retract the seat cushion length. Always make sure that the shoulder belt strap is correctly routed from the vehicle belt sash guide to the shoulder belt guide on the child restraint system. The shoulder belt strap must be routed forwards and downwards from the vehicle belt sash guide. If necessary, adjust the vehicle belt sash guide and the front-passenger seat accordingly. Always observe the child restraint system manufacturer's installation instructions.

If OCS determines that:

- The front-passenger seat is unoccupied, the PASSENGER AIR BAG OFF indicator lamp lights up after the system self-test and

remains lit. This indicates that the front-passenger front air bag is deactivated.

- The front-passenger seat is occupied by a child of up to twelve months old, in a standard child restraint system, the PASSENGER AIR BAG OFF indicator lamp lights up after the system self-test and remains lit. This indicates that the front-passenger front air bag is deactivated.

But even in the case of a twelve-month-old child, in a standard child restraint system, the PASSENGER AIR BAG OFF indicator lamp can go out after the system self-test. This indicates that the front-passenger front air bag is activated. The result of the classification is dependent on, among other factors, the child restraint system and the child's stature. It is recommended that you install the child restraint system on a suitable rear seat.

- The front-passenger seat is occupied by a person of smaller stature (e.g. a teenager or small adult), the PASSENGER AIR BAG OFF indicator lamp lights up and remains lit after the system self-test depending on the result of the classification or, alternatively, goes out.
 - If the PASSENGER AIR BAG OFF indicator lamp is off, move the front-passenger seat as far back as possible. Alternatively, a person of smaller stature can sit on a rear seat.
 - If the PASSENGER AIR BAG OFF indicator lamp is lit, a person of smaller stature should not use the front-passenger seat.
- The front-passenger seat is occupied by an adult or a person of adult stature, the PASSENGER AIR BAG OFF indicator lamp goes out after the system self-test. This indicates that the front-passenger front air bag is activated.

If children are traveling in the vehicle, be sure to observe the notes on "Children in the vehicle" (▷ page 50).

When the Occupant Classification System (OCS) is malfunctioning, the red  restraint system warning lamp on the instrument cluster and the PASSENGER AIR BAG OFF indicator lamp light up simultaneously. The front-passenger front air bag is deactivated in this case and does not deploy during an accident. Have the Occupant Classification System (OCS) checked and repaired immediately at a qualified specialist workshop. Mercedes-Benz recommends that you use an authorized Mercedes-Benz Center for this purpose.

If the front-passenger seat, the seat cover or the seat cushion are damaged, have the necessary repair work carried out at a qualified specialist workshop. Mercedes-Benz recommends that you use an authorized Mercedes-Benz Center for this purpose.

For safety reasons, Mercedes-Benz recommends that you only use seat accessories that have been approved by Mercedes-Benz.

If the driver's air bag deploys, this does not mean that the front-passenger front air bag will also deploy. The Occupant Classification System (OCS) categorizes the occupant on the front-passenger seat. Depending on that result, the front-passenger front air bag is either enabled or deactivated.

System self-test

DANGER

If both the PASSENGER AIR BAG OFF and PASSENGER AIR BAG ON indicator lamps do not light up during the system self-test, the system is malfunctioning. The front-passenger front air bag might be triggered unintentionally or might not be triggered at all in the event of an accident with high deceleration. This poses an increased risk of injury or even fatal injury.

In this case the front-passenger seat may not be used. Do not install a child restraint system on the front-passenger seat. Have the Occupant Classification System (OCS) checked and repaired immediately at a qualified specialist workshop.

WARNING

If the PASSENGER AIR BAG OFF indicator lamp remains lit after the system self-test, the front-passenger front air bag is disabled. It will not be deployed in the event of an accident. In this case, the front-passenger front air bag cannot perform its intended protective function, e.g. when a person is seated in the front-passenger seat.

That person could, for example, come into contact with the vehicle's interior, especially if the person is sitting too close to the dash-

board. This poses an increased risk of injury or even fatal injury.

When the front-passenger seat is occupied, always ensure that:

- the classification of the person in the front-passenger seat is correct and the front-passenger front air bag is enabled or disabled in accordance with the person in the front-passenger seat
- the person is seated properly with a correctly fastened seatbelt
- the front-passenger seat has been moved as far back as possible

If the PASSENGER AIR BAG OFF indicator lamp remains lit when it should not, the front-passenger seat may not be used. Do not install a child restraint system on the front-passenger seat. Have the Occupant Classification System (OCS) checked and repaired immediately at a qualified specialist workshop.

WARNING

Objects between the seat surface and the child restraint system could affect OCS operation. This could result in the front-passenger air bag not functioning as intended during an accident. This poses an increased risk of injury or even fatal injury.

Do not place any objects between the seat surface and the child restraint system. The entire base of the child restraint system must always rest on the seat cushion of the front-passenger seat. The backrest of the forward-facing child restraint system must, as far as possible, be resting on the backrest of the front-passenger seat. Always comply with the child restraint system manufacturer's installation instructions.

After the system self-test, the PASSENGER AIR BAG OFF or PASSENGER AIR BAG ON indicator lamp displays the status of the front-passenger front air bag (▷ page 45). If the front-passenger front air bag is enabled, the PASSENGER AIR BAG ON indicator lamp lights up for 60 seconds and then goes out.

If the PASSENGER AIR BAG ON indicator lamp is off, only the PASSENGER AIR BAG OFF indicator lamp shows the status of the front-passenger front air bag. The PASSENGER AIR BAG OFF indicator lamp may be lit continuously or be off.

For more information about the OCS, see "Problems with the Occupant Classification System" (▷ page 48).

Problems with the Occupant Classification System (OCS)

Be sure to observe the notes on "System self-test" (▷ page 47).

| Problem | Possible causes/consequences and ► Solutions |
|--|---|
| <p>The PASSENGER AIR BAG OFF indicator lamp lights up and remains lit, even though the front-passenger seat is occupied by an adult or a person of a stature corresponding to that of an adult.</p> | <p>The classification of the person on the front-passenger seat is incorrect.</p> <ul style="list-style-type: none"> ► Make sure the conditions for a correct classification of the person on the front-passenger seat are met (▷ page 44). ► If the PASSENGER AIR BAG OFF indicator lamp remains lit, the front-passenger seat may not be used. ► Have OCS checked as soon as possible at an authorized Mercedes-Benz Center. |
| <p>The PASSENGER AIR BAG OFF indicator lamp does not light up and/or does not stay on.</p> <p>The front-passenger seat is:</p> <ul style="list-style-type: none"> • unoccupied • occupied by the weight of a child up to twelve months old in a child restraint system | <p>OCS is malfunctioning.</p> <ul style="list-style-type: none"> ► Make sure there is nothing between the seat cushion and the child seat. ► Make sure that the entire base of the child restraint system rests on the seat cushion of the front-passenger seat. The backrest of the forward-facing child restraint system must lie as flat as possible against the backrest of the front-passenger seat. If necessary, adjust the position of the front-passenger seat. ► Make sure that the seat cushion length is fully retracted. ► When installing the child restraint system, make sure that the seat belt is tight. Do not pull the seat belt tight using the front-passenger seat adjustment. This could result in the seat belt and the child restraint system being pulled too tightly. ► Check for correct installation of the child restraint system. Make sure that the head restraint does not apply a load to the child restraint system. If necessary, adjust the head restraint accordingly. ► Make sure that no objects are applying additional weight onto the seat. ► If the PASSENGER AIR BAG OFF indicator lamp remains off and/or the PASSENGER AIR BAG ON indicator lamp lights up, do not install a child restraint system on the front-passenger seat. It is recommended that you install the child restraint system on a suitable rear seat. ► Have OCS checked as soon as possible at an authorized Mercedes-Benz Center. |

Deployment of Emergency Tensioning Devices and air bags

Important safety notes

WARNING

The air bag parts are hot after an air bag has been deployed. There is a risk of injury.

Do not touch the air bag parts. Have a deployed air bag replaced at a qualified specialist workshop as soon as possible.

WARNING

A deployed air bag no longer offers any protection and cannot provide the intended protection in an accident. There is an increased risk of injury.

Have the vehicle towed to a qualified specialist workshop in order to have a deployed air bag replaced.

It is important for your safety and that of your passenger to have deployed air bags replaced and to have any malfunctioning air bags repaired. This will help to make sure the air bags continue to perform their protective function for the vehicle occupants in the event of a crash.

WARNING

Emergency Tensioning Devices that have deployed pyrotechnically are no longer operational and are unable to perform their intended protective function. This poses an increased risk of injury or even fatal injury.

Have pyrotechnically triggered Emergency Tensioning Devices replaced immediately at a qualified specialist workshop.

If Emergency Tensioning Devices are triggered or air bags are deployed, you will hear a bang, and some powder may also be released. The  restraint system warning lamp lights up. Only in rare cases will the bang affect your hearing. The powder that is released generally does not constitute a health hazard, but it may cause short-term breathing difficulties in people with asthma or other respiratory problems. Provided it is safe to do so, you should leave the vehicle immediately or open the window in order to prevent breathing difficulties.

Air bags and pyrotechnic Emergency Tensioning Devices (ETDs) contain perchlorate material, which may require special handling and regard for the environment. National guidelines must be observed during disposal. In California, see www.dtsc.ca.gov/HazardousWaste/Perchlorate/index.cfm.

Method of operation

During the first stage of a collision, the restraint system control unit evaluates important physical data relating to vehicle deceleration or acceleration, such as:

- duration
- direction
- intensity

Based on the evaluation of this data, the restraint system control unit triggers the Emergency Tensioning Devices during a frontal or rear collision.

An Emergency Tensioning Device can only be triggered, if:

- the ignition is switched on
- the components of the restraint system are operational. You can find further information under "Restraint system warning lamp" ([▷ page 38](#))
- the seat belt buckle tongue has engaged in the belt buckle of the respective front seat

The Emergency Tensioning Devices in the rear compartment are triggered independently of the lock status of the seat belts.

If the restraint system control unit detects a more severe accident, further components of the restraint system are activated independently of each other in certain frontal collision situations:

- Front air bags and driver's knee bag
- Window curtain air bag, if the system determines that deployment can offer additional protection to that provided by the seat belt

The front-passenger front air bag is activated or deactivated depending on the person on the front-passenger seat. The front-passenger front air bag can only deploy in an accident if the PASSENGER AIR BAG OFF indicator lamp is off. Observe the information on the PASSENGER AIR BAG indicator lamps ([▷ page 38](#)).

Your vehicle has two-stage front air bags. In the first deployment stage, the front air bag is filled with propellant gas. The front air bag is fully

deployed with the maximum amount of propellant gas if a second deployment threshold is reached within a few milliseconds.

The activation threshold of the Emergency Tensioning Devices and the air bags is determined by evaluating the rate of vehicle deceleration or acceleration which occurs at various points in the vehicle. This process is pre-emptive in nature. Deployment should take place in good time at the start of the collision.

The rate of vehicle deceleration or acceleration and the direction of the force are essentially determined by:

- the distribution of forces during the collision
- the collision angle
- the deformation characteristics of the vehicle
- the characteristics of the object with which the vehicle has collided

Factors which can only be seen and measured after a collision has occurred do not play a decisive role in the deployment of an air bag. Nor do they provide an indication of air bag deployment.

The vehicle can be deformed considerably, without an air bag being deployed. This is the case if only parts which are relatively easily deformed are affected and the rate of deceleration is not high. Conversely, air bags may be deployed even though the vehicle suffers only minor deformation. This is the case if, for example, very rigid vehicle parts such as longitudinal body members are hit, and sufficient deceleration occurs as a result.

If the restraint system control unit detects a side impact, the relevant restraint system components are deployed independently of each other.

- Side impact air bags on the side where the impact takes place, independently of the Emergency Tensioning Device and the use of the seat belt on the driver's seat and outer seats in the second row

The side impact air bag on the front-passenger side deploys under the following conditions:

- the OCS system detects that the front-passenger seat is occupied or
- the seat belt buckle tongue is engaged in the belt buckle of the front-passenger seat
- Window curtain air bag on the side of impact, independently of the use of the seat belt and

independently of whether the front-passenger seat is occupied

- Emergency Tensioning Devices, if the system determines that deployment can offer additional protection in this situation

i Not all air bags are deployed in an accident. The different air bag systems work independently of each other.

How the air bag system works is determined by the severity of the accident detected, especially the vehicle deceleration or acceleration and the apparent type of accident:

- Frontal collision
- Side impact

Automatic measures after an accident

Immediately after an accident, the following measures are implemented, depending on the type and severity of the impact:

- the hazard warning lamps are activated
- the emergency lighting is activated
- the vehicle doors are unlocked
- the front side windows are lowered
- the engine is switched off and the fuel supply is cut off
- vehicles with mbrace: automatic emergency call

Children in the vehicle

Important safety notes

Accident statistics show that children secured in the rear seats are safer than children secured in the front-passenger seat. For this reason, Mercedes-Benz strongly advises that you install a child restraint system on a rear seat. Children are generally better protected there.

If a child younger than twelve years old and under 5 ft (1.50 m) in height is traveling in the vehicle:

- always secure the child in a child restraint system suitable for Mercedes-Benz vehicles. The child restraint system must be appropriate to the age, weight and size of the child.
- be sure to observe the instructions and safety notes in this section in addition to the child

restraint system manufacturer's installation instructions.

- always observe the instructions and safety notes on the "Occupant classification system (OCS)". (▷ page 44)

WARNING

If you leave children unsupervised in the vehicle, they could set it in motion by, for example:

- release the parking brake.
- shift the automatic transmission out of the parking position **P**.
- start the engine.

In addition, they may operate vehicle equipment and become trapped. There is a risk of an accident and injury.

When leaving the vehicle, always take the SmartKey with you and lock the vehicle. Never leave children unsupervised in the vehicle.

WARNING

If persons, particularly children are subjected to prolonged exposure to extreme heat or cold, there is a risk of injury, possibly even fatal. Never leave children unattended in the vehicle.

WARNING

If the child restraint system is subjected to direct sunlight, parts may get very hot. Children may burn themselves on these parts, particularly on the metal parts of the child restraint system. There is a risk of injury.

If you leave the vehicle, taking the child with you, always ensure that the child restraint system is not exposed to direct sunlight. Protect it with a blanket, for example. If the child restraint system has been exposed to direct sunlight, let it cool down before securing the child in it. Never leave children unattended in the vehicle.

Always ensure that all vehicle occupants have their seat belts fastened correctly and are sitting properly. Particular attention must be paid to children.

Observe the safety notes on the seat belt (▷ page 39) and the notes on correct use of seat belts (▷ page 40).

A booster seat may be necessary to achieve proper seat belt positioning for children over 40 lbs (18 kg) until they reach a height where a three-point seat belt can be properly fastened without a booster seat.

Special seatbelt retractor

WARNING

If the seat belt is released while driving, the child restraint system will no longer be secured properly. The special seat belt retractor is disabled and the inertia reel draws in a portion of the seat belt. The seat belt cannot be immediately refastened. There is an increased risk of injury, possibly even fatal. Stop the vehicle immediately, paying attention to road and traffic conditions. Reactivate the special seat belt retractor and secure the child restraint system properly.

All seat belts in the vehicle, except the driver's seat belt, are equipped with a special seat belt retractor. When activated, the special seat belt retractor ensures that the seat belt cannot slacken once the child seat is secured.

Installing a child restraint system:

- ▶ Make sure you observe the child restraint system manufacturer's installation instructions.
- ▶ Pull the seat belt smoothly from the belt outlet.
- ▶ Engage seat belt tongue in belt buckle.

Activating the special seat belt retractor:

- ▶ Pull the seat belt out fully and let the inertia reel retract it again. While the seat belt is retracting, you should hear a ratcheting sound. The special seat belt retractor is enabled.
- ▶ Push the child restraint system down so that the seat belt is tight and does not loosen.

Removing the child restraint system and deactivating the special seat belt retractor:

- ▶ Make sure you observe the child restraint system manufacturer's installation instructions.
- ▶ Press the release button of the seat belt buckle and guide the seat belt tongue back towards the belt sash guide. The special seat belt retractor is deactivated.

Child restraint system

The use of seat belts and child restraint systems is required by law in:

- all 50 states
- the U.S. territories
- the District of Columbia
- all Canadian provinces

If you install a rearward-facing child restraint system on the center rear seat, the rear arm rest must be folded back as far as possible.

You can obtain further information about the correct child restraint system from any authorized Mercedes-Benz Center.

WARNING

If the child restraint system is installed incorrectly on a suitable seat, it cannot protect as intended. The child cannot then be restrained in the event of an accident, heavy braking or sudden changes of direction. There is an increased risk of injury, possibly even fatal.

Make sure that you observe the child restraint system manufacturer's installation instructions and the notes on use. Please ensure, that the base of the child restraint system is always resting completely on the seat cushion. Never place objects, e.g. cushions, under or behind the child restraint system. Only use child restraint systems with the original cover designed for them. Only replace damaged covers with genuine covers.

WARNING

If the child restraint system is installed incorrectly or is not secured, it can come loose in the event of an accident, heavy braking or a sudden change in direction. The child

restraint system could be thrown about, striking vehicle occupants. There is an increased risk of injury, possibly even fatal.

Always install child restraint systems properly, even if they are not being used. Make sure that you observe the child restraint system manufacturer's installation instructions.

You will find further information on stowing objects, luggage or loads under "Loading guidelines" (▶ page 221).

WARNING

Child restraint systems or their securing systems which have been damaged or subjected to a load in an accident can no longer protect as intended. The child cannot then be restrained in the event of an accident, heavy braking or sudden changes of direction. There is an increased risk of injury, possibly even fatal.

Replace child restraint systems which have been damaged or subjected to a load in an accident as soon as possible. Have the securing systems on the child restraint system checked at a qualified specialist workshop, before you install a child restraint system again.

The securing systems of child restraint systems are:

- the seat belt system
- the LATCH-type (ISOFIX) securing rings
- the Top Tether anchorages

If it is absolutely necessary to carry a child on the front-passenger seat, be sure to observe the information on the "Occupant Classification System (OCS)" (▶ page 44). There you will also find information on deactivating the front-passenger front air bag.

All child restraint systems must meet the following standards:

- U.S. Federal Motor Vehicle Safety Standards 213 and 225
- Canadian Motor Vehicle Safety Standards 213 and 210.2

Confirmation that the child restraint system corresponds to the standards can be found on an instruction label on the child restraint system.

This confirmation can also be found in the installation instructions that are included with the child restraint system.

Observe the warning labels in the vehicle interior and on the child restraint system.

LATCH-type (ISOFIX) child seat securing system

WARNING

For LATCH-type (ISOFIX) child restraint systems in which the child is secured using the safety belt integrated in the child restraint system, the maximum permissible weight of the child and child restraint system together is 73 lbs (33 kg).

If the child and the child restraint system together weigh more than 73 lbs (33 kg), the LATCH-type (ISOFIX) child restraint system with integrated safety belt no longer offers sufficient protection. The LATCH-type (ISOFIX) child seat securing system may be overloaded, and the child may not be restrained in an accident, for example. This poses an increased risk of injury or even fatal injury.

If the child and the child restraint system together weigh more than 73 lbs (33 kg), use only a LATCH-type (ISOFIX) child restraint system in which the child is also secured with the vehicle seat belt. Also secure the child restraint system with the Top Tether belt, if available.

Regularly check that the permissible gross weight of the child together with the child restraint system is still maintained.

Always comply with the manufacturer's installation and operating instructions for the child restraint system used.

Before every trip, make sure that the LATCH-type (ISOFIX) child restraint system is engaged correctly in both LATCH-type (ISOFIX) securing rings

-  When installing the child restraint system, make sure that the seat belt for the middle seat does not get trapped. The seat belt could otherwise be damaged.

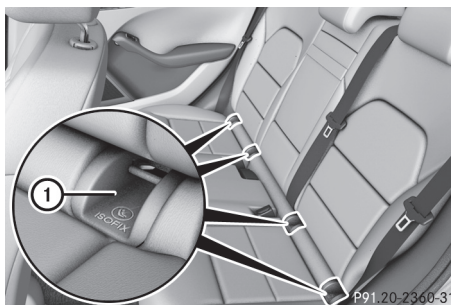

- ▶ Install the LATCH-type (ISOFIX) child restraint system on both LATCH-type (ISOFIX) securing rings ①.

LATCH-type (ISOFIX) is a standardized securing system for specially designed child restraint systems on the rear seats. LATCH-type (ISOFIX) securing rings for two LATCH-type (ISOFIX) child restraint systems are installed on the left and right of the rear seats.

Non-LATCH-type (ISOFIX) child seats may also be used and can be installed using the vehicle's seat belt system. Install the child seat according to the manufacturer's instructions.

Top Tether

Introduction

Top Tether provides an additional connection between the child restraint system secured with a LATCH-type (ISOFIX) system and the vehicle. This helps reduce the risk of injury even further. If the child restraint system is equipped with a Top Tether belt, this should always be used.

Important safety notes

WARNING

If the rear seat backrests are not locked, they could fold forwards in the event of an accident, heavy braking or sudden changes of direction. As a result, child restraint systems cannot perform their intended protective function. Rear seat backrests that are not locked can also cause additional injuries, e.g. in the event of an accident. This poses an increased risk of injury or even fatal injury.

Always lock rear seat backrests after installing a Top Tether belt. Observe the lock verification indicator. Adjust the rear seat backrests so that they are in an upright position.

If the rear backrest is not engaged and locked, the red lock verification indicator will be visible (▷ page 225).

Safety

Top Tether anchorages

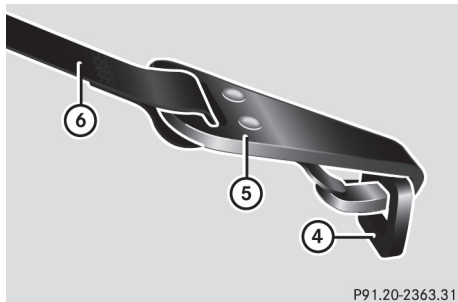
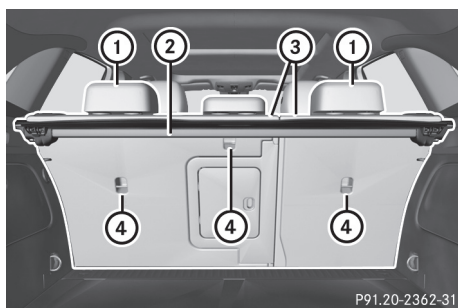

The Top Tether anchorages are located on the rear side of the seat backrests.

- ▶ Move head restraint ① up.
- ▶ Release seat backrest ③ and fold it forward (▷ page 224).
- ▶ Route Top Tether belt ⑥ under head restraint ① between the two head restraint bars.
- ▶ Hook Top Tether hook ⑤ of Top Tether belt ⑥ into Top Tether anchorage ④.

Make sure that:

- Top Tether hook ⑤ is hooked into Top Tether anchorage ④ as shown
- Top Tether belt ⑥ is not twisted
- Top Tether belt ⑥ is routed between seat backrest ③ and cargo compartment

cover ② if cargo compartment cover ② is installed

- Top Tether belt ⑥ is routed between seat backrest ③ and the cargo net if the cargo net is installed
- ▶ Swing back seat backrest ③ until it engages. The red lock verification indicator is no longer visible.
- ▶ Install the LATCH-type (ISOFIX) child restraint system with Top Tether. Always comply with the child restraint system manufacturer's installation instructions when doing so.
- ▶ Tension Top Tether belt ⑥. Always comply with the child restraint system manufacturer's installation instructions when doing so.
- ▶ Move head restraint ① back down again slightly if necessary (▷ page 86). Make sure that you do not interfere with the correct routing of Top Tether belt ⑥.

Child restraint system on the front-passenger seat

General notes

Accident statistics show that children secured in the rear seats are safer than children secured in the front-passenger seat. For this reason, Mercedes-Benz strongly advises that you install the child restraint system on a rear seat.

If it is absolutely necessary to install a child restraint system on the front-passenger seat, always observe the instructions and safety notes on the "Occupant Classification System (OCS)" (▷ page 44).

You can thus avoid the risks that could arise as a result of:

- an incorrectly categorized person in the front-passenger seat
- the unintentional deactivation of the front-passenger front air bag
- the unsuitable positioning of the child restraint system, e.g. too close to the dashboard

Rearward-facing child restraint system

If it is absolutely necessary to install a rearward-facing child restraint system on the front-passenger seat, always make sure that the front-passenger front air bag is deactivated. Only if the PASSENGER AIR BAG OFF indicator

lamp is permanently lit (▷ page 38) is the front-passenger front air bag deactivated.

Always observe the child restraint system manufacturer's installation and operating instructions.

Forward-facing child restraint system

If it is absolutely necessary to install a forward-facing child restraint system on the front-passenger seat, always move the front-passenger seat as far back as possible. Fully retract the seat cushion length. The entire base of the child restraint system must always rest on the seat cushion of the front-passenger seat. The backrest of the child restraint system must lie as flat as possible against the backrest of the front-passenger seat. The child restraint system must not touch the roof or be subjected to a load by the head restraint. Adjust the angle of the seat backrest and the head restraint position accordingly. Always make sure that the shoulder belt strap is correctly routed from the vehicle belt outlet to the shoulder belt guide on the child restraint system. The shoulder belt strap must be routed forward and down from the vehicle belt outlet. If necessary, adjust the vehicle belt outlet and the front-passenger seat accordingly.

Always observe the child restraint system manufacturer's installation and operating instructions.

Child-proof locks

Important safety notes

WARNING

If children are traveling in the vehicle, they could:

- open doors, thus endangering other people or road users
- exit the vehicle and be caught by oncoming traffic
- operate vehicle equipment and become trapped

There is a risk of an accident and injury.

Always activate the child-proof locks and override feature if children are traveling in the vehicle. When leaving the vehicle, always take

the key with you and lock the vehicle. Never leave children unattended in the vehicle.

Override feature for:

- the rear doors (▷ page 56)
- the rear side windows (▷ page 56)

WARNING

If you leave children unsupervised in the vehicle, they could set it in motion by, for example:

- release the parking brake.
- shift the automatic transmission out of the parking position **P**.
- start the engine.

In addition, they may operate vehicle equipment and become trapped. There is a risk of an accident and injury.

When leaving the vehicle, always take the SmartKey with you and lock the vehicle. Never leave children unsupervised in the vehicle.

WARNING

If persons, particularly children are subjected to prolonged exposure to extreme heat or cold, there is a risk of injury, possibly even fatal. Never leave children unattended in the vehicle.

WARNING

If the child restraint system is subjected to direct sunlight, parts may get very hot. Children may burn themselves on these parts, particularly on the metal parts of the child restraint system. There is a risk of injury.

If you leave the vehicle, taking the child with you, always ensure that the child restraint system is not exposed to direct sunlight. Protect it with a blanket, for example. If the child restraint system has been exposed to direct sunlight, let it cool down before securing the child in it. Never leave children unattended in the vehicle.

Child-proof locks for the rear doors

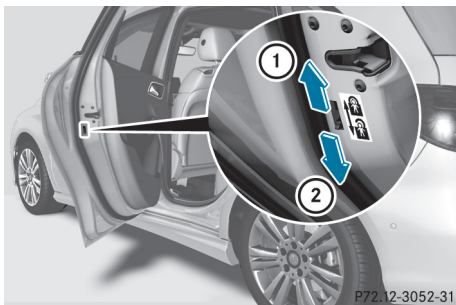

You secure each door individually with the child-proof locks on the rear doors. A door secured with a child-proof lock cannot be opened from inside the vehicle. When the vehicle is unlocked, the door can be opened from the outside.

- ▶ **To activate:** press the child-proof lock lever up in the direction of arrow ①.
- ▶ Make sure that the child-proof locks are working properly.
- ▶ **To deactivate:** press the child-proof lock lever down in the direction of arrow ②.

Override feature for the rear side windows

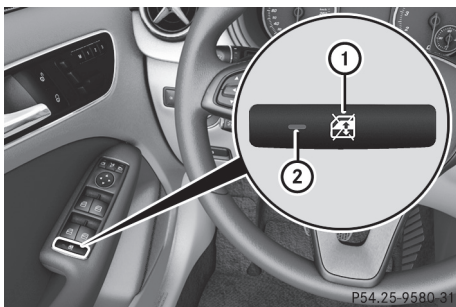

- ▶ **To activate/deactivate:** press button ①. If indicator lamp ② is lit, operation of the rear side windows is disabled. Operation is only possible using the switches in the driver's door. If indicator lamp ② is off, operation is possible using the switches in the rear compartment.

Pets in the vehicle

⚠ WARNING

If you leave animals unattended or unsecured in the vehicle, they could press buttons or switches, for example.

As a result, they could:

- activate vehicle equipment and become trapped, for example
- activate or deactivate systems, thereby endangering other road users

Unsecured animals could also be flung around the vehicle in the event of an accident or sudden steering or braking, thereby injuring vehicle occupants. There is a risk of an accident and injury.

Never leave animals unattended in the vehicle. Always secure animals properly during the journey, e.g. use a suitable animal transport box.

Driving safety systems

Overview of driving safety systems

In this section, you will find information about the following driving safety systems:

- ABS (**A**nti-**l**ock **B**raking **S**ystem) (▷ page 57)
- BAS (**B**rake **A**ssist **S**ystem) (▷ page 57)
- Active Brake Assist (▷ page 58)
- ESP® (**E**lectronic **S**tability **P**rogram) (▷ page 60)
- EBD (**E**lectronic **B**rake force **D**istribution) (▷ page 62)
- ADAPTIVE BRAKE (▷ page 62)
- STEER CONTROL (▷ page 62)

Important safety notes

If you fail to adapt your driving style or if you are inattentive, the driving safety systems can neither reduce the risk of an accident nor override the laws of physics. Driving safety systems are merely aids designed to assist driving.

You are responsible for maintaining the distance to the vehicle in front, for vehicle speed, for braking in good time, and for staying in lane. Always adapt your driving style to suit the prevailing road and weather conditions and maintain a safe distance from the vehicle in front. Drive carefully.

The driving safety systems described only work as effectively as possible when there is adequate contact between the tires and the road surface. Please pay special attention to the notes on tires, recommended minimum tire tread depths, etc. (> page 270).

In wintry driving conditions, always use winter tires (M+S tires) and if necessary, snow chains. Only in this way will the driving safety systems described in this section work as effectively as possible.

ABS (Anti-lock Braking System)

General information

ABS regulates brake pressure in such a way that the wheels do not lock when you brake. This allows you to continue steering the vehicle when braking.

The  ABS warning lamp in the instrument cluster lights up when the ignition is switched on. It goes out when the engine is running.

ABS works from a speed of about 5 mph (8 km/h), regardless of road-surface conditions. ABS works on slippery surfaces, even when you only brake gently.

Important safety notes

 Observe the "Important safety notes" section (> page 56).

WARNING

If ABS is malfunctioning, the wheels could lock when braking. The steerability and braking characteristics would be severely affected. There is an increased danger of skidding and accidents.

Drive on carefully. Have ABS checked immediately at a qualified specialist workshop.

When ABS is malfunctioning, other systems, including driving safety systems, will also become inoperative. Observe the information

on the ABS warning lamp (> page 206) and display messages which may be shown in the instrument cluster (> page 179).

Braking

► **If ABS intervenes:** continue to depress the brake pedal vigorously until the braking situation is over.

► **To make a full brake application:** depress the brake pedal with full force.

If ABS intervenes when braking, you will feel a pulsing in the brake pedal.

The pulsating brake pedal can be an indication of hazardous road conditions, and functions as a reminder to take extra care while driving.

BAS (Brake Assist System)

General information

BAS operates in emergency braking situations. If you depress the brake pedal quickly, BAS automatically boosts the braking force, thus shortening the stopping distance.

Important safety notes

 Observe the "Important safety notes" section (> page 56).

WARNING

If BAS is malfunctioning, the braking distance in an emergency braking situation is increased. There is a risk of an accident.

In an emergency braking situation, depress the brake pedal with full force. ABS prevents the wheels from locking.

Braking

► Keep the brake pedal firmly depressed until the emergency braking situation is over. ABS prevents the wheels from locking.

The brakes will function as usual once you release the brake pedal. BAS is deactivated.

Active Brake Assist

General information

i Observe the "Important safety notes" section (▷ page 56).

Active Brake Assist consists of a distance warning function with an autonomous braking function and situation-dependent braking assistance.

Active Brake Assist can help you to minimize the risk of a collision with the vehicle traveling in front or reduce the effects of such a collision.

If Active Brake Assist detects that there is a risk of collision, you will be warned visually and acoustically. If you do not react to the visual and audible collision warning, autonomous braking can be initiated in critical situations. If you apply the brake yourself in a critical situation, Active Brake Assist supports you with situation-dependent braking assistance.

Important safety notes

Detection of hazardous situations can be particularly impaired if:

- there is dirt on the sensors or anything else covering the sensors
- there is snow or heavy rain
- there is interference by other radar sources
- there are strong radar reflections, for example in parking garages
- a narrow vehicle is traveling in front, e.g. a motorbike
- a vehicle is traveling in front on a different line
- you are driving a new vehicle or servicing on the Active Brake Assist system has just been carried out

Observe the important safety notes in the "Breaking-in notes" section (▷ page 113).

Following damage to the front end of the vehicle, have the configuration and operation of the radar sensor checked at a qualified specialist workshop. This also applies to collisions at low speeds where no visible damage to the front of the vehicle is apparent.

Activating/deactivating

Active Brake Assist is active after every ignition cycle.

You can activate or deactivate Active Brake Assist (▷ page 174) in the on-board computer. When deactivated, the distance warning function and the autonomous braking function are also deactivated.

Vehicles with a black and white multifunction display: when Active Brake Assist is activated, the  symbol appears in the status overview of the multifunction display.

Vehicles with a color multifunction display: when Active Brake Assist is deactivated, the  symbol appears in the assistance graphic display of the multifunction display.

Distance warning function

General information

The distance warning function can help you to minimize the risk of a front-end collision with a vehicle ahead or reduce the effects of such a collision. If the distance warning function detects that there is a risk of a collision, you will be warned visually and acoustically.

Important safety notes

i Observe the "Important safety notes" section for driving safety systems (▷ page 56).

WARNING

The distance warning function does not react:

- to people or animals
- to oncoming vehicles
- to crossing traffic
- when cornering

The distance warning function may not give warnings in all critical situations. There is a risk of an accident.

Always pay careful attention to the traffic situation and be ready to brake.

Always adapt your speed to suit the prevailing road and traffic conditions.

WARNING

The distance warning function cannot always clearly identify objects and complex traffic situations.

In such cases, the distance warning function may:

- give an unnecessary warning
- not give a warning

There is a risk of an accident.

Always pay careful attention to the traffic situation and do not rely solely on the distance warning function.

Function

Starting at a speed of approximately 4 mph (7 km/h), the distance warning function warns you if you rapidly approach a vehicle in front. An intermittent warning tone will then sound, and the  distance warning lamp will light up in the instrument cluster.

► Brake immediately in order to increase the distance from the vehicle in front.

or

► Take evasive action, provided it is safe to do so.

Due to the nature of the system, particularly complicated but non-critical driving conditions may also cause the system to display a warning. With the help of the radar sensor system, the distance warning function can detect obstacles that are in the path of your vehicle for an extended period of time.

Up to a speed of approximately 44 mph (70 km/h), the distance warning function can also react to stationary obstacles, such as stopped or parked vehicles.

Autonomous braking function

If the driver does not react to the distance warning signal in a critical situation, Active Brake Assist can assist the driver with the autonomous braking function.

The autonomous braking function:

- gives the driver more time to react to critical driving situations
- can help the driver to avoid an accident or
- reduces the effects of an accident

Vehicles without Distance Pilot DISTRONIC: the autonomous braking function is available in the following speed ranges:

- 4 - 65 mph (7 - 105 km/h) for moving objects
- 4 - 31 mph (7 - 50 km/h) for stationary objects

Vehicles with Distance Pilot DISTRONIC: the autonomous braking function is available in the following speed ranges:

- 4 - 124 mph (7 - 200 km/h) for moving objects
- 4 - 31 mph (7 - 50 km/h) for stationary objects

Due to the nature of the system, particularly complicated but non-critical driving conditions may also cause the Autonomous Braking Function to intervene.

Situation-dependent braking assistance

General information

- ① Observe the "Important safety notes" section (▷ page 56).

With the help of the radar sensor system, Active Brake Assist can detect obstacles that are in the path of your vehicle for an extended period of time.

If Active Brake Assist detects a risk of collision with the vehicle in front, it calculates the brake pressure necessary to avoid a collision. If you apply the brakes forcefully, situation-dependent braking assistance adapts to the situation and automatically increases the brake pressure to a degree appropriate to the traffic situation.

Situation-dependent braking assistance provides braking assistance in hazardous situations at speeds above 4 mph (7 km/h). It uses radar sensor technology to assess the traffic situation.

Situation-dependent braking assistance is capable of reacting to moving objects that have already been detected as such at least once over the period of observation, up to vehicle speeds of around 155 mph (250 km/h).

Situation-dependent braking assistance can also detect stationary objects, up to vehicle speeds of around 44 mph (70 km/h).

► Keep the brake pedal depressed until the emergency braking situation is over. ABS prevents the wheels from locking.

The brakes will work normally again if:

- you release the brake pedal.
- there is no longer any danger of a collision.
- no obstacle is detected in front of your vehicle.

Situation-dependent braking assistance is then deactivated.

Important safety notes

- i** Observe the "Important safety notes" section for driving safety systems (▷ page 56).

WARNING

Active Brake Assist does not react:

- to persons, bicycles, motorcycles or animals
- to approaching vehicles
- to cross traffic
- on bends

As a result, Active Brake Assist cannot intervene in all critical situations. There is a risk of an accident.

Always pay careful attention to the traffic situation and be prepared to brake.

WARNING

Adaptive Brake Assist cannot always clearly identify objects and complex traffic situations.

In such cases, Adaptive Brake Assist might:

- intervene unnecessarily
- not intervene

There is a risk of an accident.

Always pay careful attention to the traffic situation and be ready to brake. Terminate the intervention in a non-critical driving situation.

Due to the nature of the system, complex but non-critical driving conditions may also cause Active Brake Assist to intervene.

Even if Active Brake Assist is not available due to a malfunction in the radar sensor system, the brake system is still available with full brake boosting effect and BAS.

ESP® (Electronic Stability Program)

General notes

- i** Observe the "Important safety notes" section (▷ page 56).

ESP® monitors driving stability and traction, i.e. power transmission between the tires and the road surface.

If ESP® detects that the vehicle is deviating from the direction desired by the driver, one or more wheels are braked to stabilize the vehicle. The engine output is also modified to keep the vehicle on the desired course within physical limits. ESP® assists the driver when pulling away on wet or slippery roads. ESP® can also stabilize the vehicle during braking.

ETS/4ETS (Electronic Traction System)

- i** Observe the "Important safety notes" section (▷ page 56).

ETS traction control is part of ESP®. On vehicles with 4MATIC, 4ETS is part of ESP®.

Traction control brakes the drive wheels individually if they spin. This enables you to pull away and accelerate on slippery surfaces, for example if the road surface is slippery on one side. In addition, more drive torque is transferred to the wheel or wheels with traction.

Traction control remains active, even if you deactivate ESP®.

Important safety notes



- i** Observe the "Important safety notes" section (▷ page 56).

WARNING

If ESP® is malfunctioning, ESP® is unable to stabilize the vehicle. Additionally, further driving safety systems are deactivated. This increases the risk of skidding and an accident.

Drive on carefully. Have ESP® checked at a qualified specialist workshop.

If the  ESP® OFF warning lamp lights up continuously, ESP® is deactivated.

If the  ESP® warning lamp and the  warning lamp are lit continuously, ESP® is not available due to a malfunction.

Observe the information on warning lamps (▷ page 207) and display messages which may be shown in the instrument cluster (▷ page 179).

Only use wheels with the recommended tire sizes. Only then will ESP® function properly.

Characteristics of ESP®

General information

If the  ESP® warning lamp goes out before beginning the journey, ESP® is automatically active.

If ESP® intervenes, the  ESP® warning lamp flashes in the instrument cluster.

If ESP® intervenes:

- ▶ Do not deactivate ESP® under any circumstances.
- ▶ Only depress the accelerator pedal as far as necessary when pulling away.
- ▶ Adapt your driving style to suit the prevailing road and weather conditions.

ECO start/stop function

The ECO start/stop function switches the engine off automatically when the vehicle stops moving. The engine starts automatically when the driver wants to pull away again. ESP® remains in its previously selected status. **Example:** if ESP® was deactivated before the engine was switched off, ESP® remains deactivated when the engine is switched on again.

Deactivating/activating ESP®

Important safety notes

i Observe the "Important safety notes" section (▷ page 56).

You can select between the following states of ESP®:

- ESP® is activated.
- ESP® is deactivated.

WARNING

If you deactivate ESP®, ESP® no longer stabilizes the vehicle. There is an increased risk of skidding and an accident.

Only deactivate ESP® in the situations described in the following.

The spinning of the wheels results in a cutting action for better traction on loose surfaces.

It may be best to deactivate ESP® in the following situations:

- when using snow chains
- in deep snow
- on sand or gravel

i Activate ESP® as soon as the situations described above no longer apply. ESP® will otherwise not be able to stabilize the vehicle if the vehicle starts to skid or a wheel starts to spin.

! Avoid spinning the driven wheels for an extended period with ESP® deactivated. You could otherwise damage the drivetrain.

Deactivating/activating ESP®

You can deactivate or activate ESP® via the on-board computer (▷ page 173).

ESP® deactivated:

The  ESP® OFF warning lamp in the instrument cluster lights up.

ESP® activated:

The  ESP® OFF warning lamp in the instrument cluster goes out.

Characteristics when ESP® is deactivated

If ESP® is deactivated and one or more wheels start to spin, the  ESP® warning lamp in the instrument cluster flashes. In such situations, ESP® will not stabilize the vehicle.

If you deactivate ESP®:

- ESP® no longer improves driving stability.
- Engine torque is no longer limited and the drive wheels are able to spin.
- Traction control is still activated.
- Active Brake Assist is no longer available; nor is it activated if you brake firmly with assistance from ESP®.
- STEER CONTROL is no longer active.
- ESP® still provides support when you brake firmly.

ESP® trailer stabilization

General information

If your vehicle/trailer combination begins to swerve, ESP® assists you in this situation. ESP® slows the vehicle down by braking and limiting the engine output until the vehicle/trailer combination has stabilized.

Important safety notes

WARNING

If road and weather conditions are poor, trailer stabilization will not be able to prevent the vehicle/trailer combination from swerving. Trailers with a high center of gravity can tip over before ESP® can detect this. There is a risk of an accident.

Always adapt your driving style to the prevailing road and weather conditions.

If your vehicle with trailer (vehicle/trailer combination) begins to lurch, you can only stabilize the vehicle/trailer combination by depressing the brake firmly.

ESP® trailer stabilization is active above speeds of about 65 km/h.

ESP® trailer stabilization does not work if ESP® is deactivated or disabled because of a malfunction.

EBD (electronic brake force distribution)

General information

EBD monitors and controls the brake pressure on the rear wheels to improve driving stability while braking.

Important safety notes

 Observe the "Important safety notes" section ([▷ page 56](#)).

WARNING

If EBD is malfunctioning, the rear wheels can lock, e.g. under full braking. This increases the risk of skidding and an accident.

You should therefore adapt your driving style to the different handling characteristics. Have the brake system checked at a qualified specialist workshop.

Please observe the information on warning and indicator lamps ([▷ page 206](#)) ([▷ page 206](#)) as well as on display messages ([▷ page 181](#)).

ADAPTIVE BRAKE

ADAPTIVE BRAKE enhances braking safety and offers increased braking comfort. In addition to the braking function, ADAPTIVE BRAKE also has the HOLD function ([▷ page 146](#)) and hill start assist ([▷ page 117](#)).

STEER CONTROL

General information

STEER CONTROL helps you by transmitting a noticeable steering force to the steering wheel in the direction required for vehicle stabilization. This steering assistance is provided in particular if:

- both right wheels or both left wheels are on a wet or slippery road surface when you brake
- the vehicle begins to skid

Important safety notes

 Observe the "Important safety notes" section ([▷ page 56](#)).

No steering assistance is provided from STEER CONTROL, if:

- ESP® is malfunctioning
- the steering is malfunctioning

If ESP® is malfunctioning, you will be assisted further by the electrical power steering.

Protection against theft

Immobilizer

The immobilizer prevents your vehicle from being started without the correct SmartKey.

- ▶ **To activate with the SmartKey:** remove the SmartKey from the ignition lock.
- ▶ **To activate with KEYLESS-GO start-function or KEYLESS-GO:** switch the ignition off and open the driver's door.
- ▶ **To deactivate:** switch on the ignition.

When leaving the vehicle, always take the SmartKey with you and lock the vehicle. Anyone can start the engine if a valid SmartKey has been left inside the vehicle.

i The immobilizer is always deactivated when you start the engine.

In the event that the engine cannot be started (yet the vehicle's battery is charged), the system is not operational. Contact an authorized Mercedes-Benz Center or call 1-800-FOR-MERCEdes (in the USA) or 1-800-387-0100 (in Canada).

ATA (anti-theft alarm system)





- ▶ **To arm:** lock the vehicle with the SmartKey or KEYLESS-GO. Indicator lamp ① flashes. The alarm system is armed after approximately 15 seconds.
- ▶ **To disarm:** unlock the vehicle with the SmartKey or KEYLESS-GO.

or

- ▶ Insert the SmartKey into the ignition lock.

A visual and audible alarm is triggered if the alarm system is armed and you open:

- a door
- the vehicle with the mechanical key
- the tailgate
- the hood

- ▶ **To turn the alarm off with the SmartKey:** press the  or  button on the SmartKey.

The alarm is stopped.

or

- ▶ **Vehicles with KEYLESS-GO start-function or KEYLESS-GO:** remove the Start/Stop button from the ignition lock (▷ page 114).

- ▶ Insert the SmartKey into the ignition lock. The alarm is stopped.

- ▶ **To stop the alarm using KEYLESS-GO:** grasp the outside door handle. The SmartKey must be outside the vehicle. The alarm is stopped.

or

- ▶ Press the Start/Stop button on the dashboard. The SmartKey must be inside the vehicle.

The alarm is stopped.

The alarm is not switched off, even if you close the open door that triggered it, for example.

SmartKey

Important safety notes

WARNING

If children are left unsupervised in the vehicle, they could:

- operate the vehicle's equipment.
- Additionally, children could set the vehicle in motion if, for example, they:
- release the parking brake
 - shift the automatic transmission out of park position **P**
 - start the engine

There is a risk of an accident and injury.

Never leave children or animals unattended in the vehicle.

When leaving the vehicle, always take the SmartKey with you and lock the vehicle. This also applies to mobile phones if the "Digital Car Key in smartphone" function is activated via the Mercedes me connect web app.

WARNING

If you attach heavy or large objects to the SmartKey, the SmartKey could be unintentionally turned in the ignition lock. This could cause the engine to be switched off. There is a risk of an accident.

Do not attach any heavy or large objects to the SmartKey. Remove any bulky key rings before inserting the SmartKey into the ignition lock.

- ❗ Keep the SmartKey away from strong magnetic fields. Otherwise, the remote control function could be affected.

Strong magnetic fields can occur in the vicinity of powerful electrical installations.

Do not keep the SmartKey:

- with electronic devices, e.g. a mobile phone or another SmartKey
- with metallic objects, e.g. coins or metal foil
- inside metallic objects, e.g. a metal case



Vehicles with KEYLESS-GO start function: do not keep the SmartKey in the cargo compartment. Otherwise, the SmartKey may not be

detected, e.g. when starting the engine using the Start/Stop button.

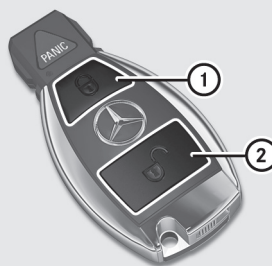
SmartKey functions



P80.35-2499-31

- ①  To lock the vehicle
- ②  To unlock the vehicle

► **To unlock centrally:** press the  button.

If you do not open the vehicle within approximately 40 seconds of unlocking:

- the vehicle is locked again
- anti-theft protection is reactivated

► **To lock:** press the  button.

The SmartKey centrally locks/unlocks:

- the doors
- the tailgate
- the fuel filler flap

The turn signals flash once when unlocking and three times when locking.

When the locator lighting is activated via the multimedia system, it lights up when it is dark after the vehicle is unlocked with the remote control; see Digital Operator's Manual.

You can also set an audible signal to confirm that the vehicle has been locked. The audible signal can be activated and deactivated using the on-board computer (► page 176).

KEYLESS-GO

General notes

Bear in mind that the engine can be started by any of the vehicle occupants if there is a SmartKey in the vehicle.

Locking and unlocking

You can start, lock or unlock the vehicle using KEYLESS-GO. To do this, you only need carry the SmartKey with you. You can combine the functions of KEYLESS-GO with those of a conventional SmartKey. Unlock the vehicle by using KEYLESS-GO, for instance, and lock it using the  button on the SmartKey.

The driver's door and the door at which the handle is used, must both be closed. The SmartKey must be outside the vehicle. When locking or unlocking with KEYLESS-GO, the distance between the SmartKey and the corresponding door handle must not be greater than three feet (one meter).

A check which periodically establishes a radio connection between the vehicle and the SmartKey determines whether a valid SmartKey is in the vehicle. This occurs, for example:

- when starting the engine
- while driving
- when the external door handles are touched
- during convenience closing

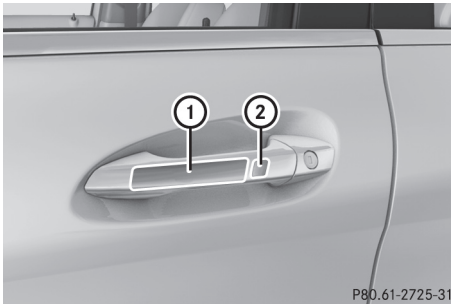

- ▶ **To unlock the vehicle:** touch the inner surface of the door handle.
- ▶ **To lock the vehicle:** touch sensor surface ① or ②.
Make sure that you do not touch the inner surface of the door handle.
- ▶ **Convenience closing feature:** touch recessed sensor surface ② for an extended period.
Further information on the convenience closing feature (▷ page 76).

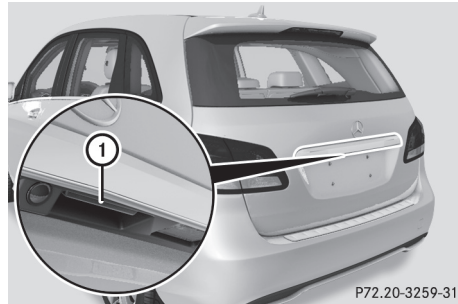

- ▶ **To unlock the tailgate:** pull tailgate handle ①.

Deactivating and activating

If you do not intend to use the vehicle for a longer period of time, you can deactivate KEYLESS-GO. The SmartKey will then use very little power, thereby conserving battery power. For the purposes of activation/deactivation, the vehicle must not be nearby.

- ▶ **To deactivate:** press the  button on the SmartKey twice in rapid succession. The indicator light on the SmartKey flashes twice briefly then one long flash, then KEYLESS-GO is deactivated (▷ page 67).
- ▶ **To activate:** press any button on the SmartKey.

or

- ▶ Insert the SmartKey into the ignition lock. KEYLESS-GO and all of its associated features are available again.



KEYLESS-GO start function



General notes

Bear in mind that the engine can be started by any of the vehicle occupants if there is a SmartKey in the vehicle.

Changing the settings of the locking system



You can change the settings of the locking system. This means that only the driver's door and the fuel filler flap are unlocked when the vehicle is unlocked. This is useful if you frequently travel on your own.

- ▶ **To change the setting:** press and hold the  and  buttons simultaneously for approximately six seconds until the battery indicator lamp flashes twice (▷ page 67).



If the setting of the locking system is changed within the signal range of the vehicle, pressing the  or  button:

- locks or
- unlocks the vehicle

The SmartKey now functions as follows:

- ▶ **To unlock:** press the  button once.
- ▶ **To unlock centrally:** press the  button twice.
- ▶ **To lock centrally:** press the  button.

The KEYLESS-GO function is changed as follows:

- ▶ **To unlock the driver's door:** touch the inner surface of the door handle on the driver's door.
- ▶ **To unlock centrally:** touch the inner surface of the door handle on the front-passenger door or the rear door.
- ▶ **To lock centrally:** touch the outer sensor surface on one of the door handles.
- ▶ **To restore the factory settings:** press and hold the  and  buttons simultaneously for approximately six seconds until the battery check lamp flashes twice (▷ page 67).



Mechanical key

General notes

If the vehicle can no longer be locked or unlocked with the SmartKey or KEYLESS-GO, use the mechanical key.

If you use the mechanical key to unlock and open the driver's door or the trunk lid, the anti-theft alarm system will be triggered (▷ page 63).

There are several ways to turn off the alarm:

- ▶ **To deactivate the alarm with the key:** press the  or  button on the key.
- or
- ▶ Insert the SmartKey into the ignition lock.
- or
- ▶ **To deactivate the alarm with KEYLESS-GO:** press the Start/Stop button in the ignition lock. The SmartKey must be in the vehicle.
- or
- ▶ Lock or unlock the vehicle using KEYLESS-GO. The SmartKey must be outside the vehicle.

If you unlock the vehicle using the mechanical key, the fuel filler flap will not be unlocked automatically.

- ▶ **To unlock the fuel filler flap:** insert the SmartKey into the ignition lock.

Removing the mechanical key

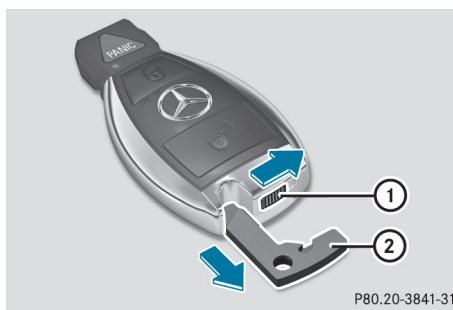

P80.20-3841-31

- ▶ Push release catch ① in the direction of the arrow and at the same time remove mechanical key ② from the SmartKey.

For further information about:

- Unlocking the driver's door (▷ page 71)
- Locking the vehicle (▷ page 71)

Inserting the mechanical key

- ▶ Push mechanical key ② completely into the SmartKey until it engages and release catch ① is back in its basic position.

SmartKey battery

Important safety notes

WARNING

Batteries contain toxic and corrosive substances. If batteries are swallowed, it can result in severe health problems. There is a risk of fatal injury.





Keep batteries out of the reach of children. If a battery is swallowed, seek medical attention immediately.

The SmartKey batteries contain perchlorate material, which may require special handling and regard for the environment. National guidelines must be observed during disposal. In California, see www.dtsc.ca.gov/HazardousWaste/Perchlorate/index.cfm.

Mercedes-Benz recommends that you have the battery replaced at a qualified specialist workshop.

Checking the battery



- ▶ Press the  or  button. The battery is working properly if battery check lamp ① lights up briefly. The battery is discharged if battery check lamp ① does not light up briefly.
- ▶ Change the battery (> page 67).
- i** If the SmartKey battery is checked within the signal reception range of the vehicle, pressing the  or  button:
 - locks or
 - unlocks the vehicle
- i** You can get a battery at any qualified specialist workshop.

Replacing the battery

You require a CR 2025 3 V cell battery.

- ▶ Take the mechanical key out of the SmartKey (> page 66).

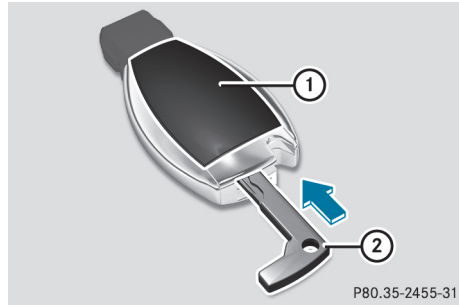



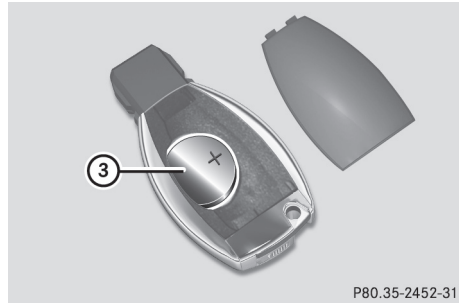

- ▶ Press mechanical key ② into the opening in the SmartKey in the direction of the arrow until battery tray cover ① opens. When doing so, do not hold cover ① shut.
- ▶ Remove battery tray cover ①.



- ▶ Repeatedly tap the SmartKey against your palm until battery ③ falls out.
- ▶ Insert the new battery with the positive terminal facing upwards. Use a lint-free cloth to do so.
- ▶ Make sure that the surface of the battery is free of lint, grease and other contaminants.
- ▶ Insert the front tabs of battery tray cover ① and then press to close it.
- ▶ Insert mechanical key into the SmartKey (> page 66).
- ▶ Check the function of all SmartKey buttons on the vehicle.

Problems with the SmartKey

| Problem | Possible causes/consequences and ► Solutions |
|--|--|
| You cannot lock or unlock the vehicle using the SmartKey. | <p>The SmartKey battery is discharged or nearly discharged.</p> <p>► Vehicles without KEYLESS-GO or KEYLESS-GO start function: try again to lock/unlock the vehicle using the remote control function of the SmartKey. Point the tip of the SmartKey at the driver's door handle from close range and press the  or  button.</p> <p>If this does not work:</p> <p>► Check the SmartKey battery (▷ page 67) and replace it if necessary (▷ page 67).</p> <p>► Unlock (▷ page 71) or lock (▷ page 71) the vehicle using the mechanical key.</p> <p>There is interference from a powerful source of radio waves.</p> <p>► Vehicles without KEYLESS-GO or KEYLESS-GO start function: try again to lock/unlock the vehicle using the remote control function of the SmartKey. Point the tip of the SmartKey at the driver's door handle from close range and press the  or  button.</p> <p>If this does not work:</p> <p>► Unlock (▷ page 71) or lock (▷ page 71) the vehicle using the mechanical key.</p> <p>The SmartKey is faulty.</p> <p>► Unlock (▷ page 71) or lock (▷ page 71) the vehicle using the mechanical key.</p> <p>► Have the SmartKey checked at a qualified specialist workshop.</p> |
| You can no longer lock or unlock the vehicle using KEYLESS-GO. | <p>The SmartKey battery is discharged or nearly discharged.</p> <p>► Check the SmartKey battery (▷ page 67) and replace it if necessary (▷ page 67).</p> <p>If this does not work:</p> <p>► Unlock (▷ page 71) or lock (▷ page 71) the vehicle using the mechanical key.</p> <p>There is interference from a powerful source of radio waves.</p> <p>► Unlock (▷ page 71) or lock (▷ page 71) the vehicle using the mechanical key.</p> |

| Problem | Possible causes/consequences and ► Solutions |
|---|--|
| | <p>KEYLESS-GO is malfunctioning.</p> <ul style="list-style-type: none"> ► Lock/unlock the vehicle using the remote control function of the SmartKey. ► Have the vehicle and SmartKey checked at a qualified specialist workshop. <p>If the vehicle can also not be locked/unlocked using the remote control function:</p> <ul style="list-style-type: none"> ► Unlock (▷ page 71) or lock (▷ page 71) the vehicle using the mechanical key. ► Have the vehicle and SmartKey checked at a qualified specialist workshop. |
| The engine cannot be started using the SmartKey. | <p>The on-board voltage is too low.</p> <ul style="list-style-type: none"> ► Switch off non-essential consumers, e.g. seat heating or interior lighting, and try to start the engine again. <p>If this does not work:</p> <ul style="list-style-type: none"> ► Check the starter battery and charge it if necessary (▷ page 260). <p>or</p> <ul style="list-style-type: none"> ► Jump-start the vehicle (▷ page 260). <p>or</p> <ul style="list-style-type: none"> ► Consult a qualified specialist workshop. |
| The engine cannot be started using the Start/Stop button. The SmartKey is in the vehicle. | <p>The vehicle is locked.</p> <ul style="list-style-type: none"> ► Unlock the vehicle and try to start the vehicle again. <p>The SmartKey battery is discharged or nearly discharged.</p> <ul style="list-style-type: none"> ► Check the SmartKey battery (▷ page 67) and replace it if necessary (▷ page 67). <p>If this does not work:</p> <ul style="list-style-type: none"> ► Start your vehicle with the SmartKey in the ignition lock. <p>There is interference from a powerful source of radio waves.</p> <ul style="list-style-type: none"> ► Start your vehicle with the SmartKey in the ignition lock. |
| You have lost a SmartKey. | <ul style="list-style-type: none"> ► Have the SmartKey deactivated at a qualified specialist workshop. ► Report the loss immediately to the vehicle insurers. ► If necessary, have the locks changed as well. |
| You have lost the mechanical key. | <ul style="list-style-type: none"> ► Report the loss immediately to the vehicle insurers. ► If necessary, have the locks changed as well. |

Doors

Important safety notes

WARNING

If children are left unsupervised in the vehicle, they could:

- operate the vehicle's equipment.
- Additionally, children could set the vehicle in motion if, for example, they:
- release the parking brake
 - shift the automatic transmission out of park position **P**
 - start the engine

There is a risk of an accident and injury.

Never leave children or animals unattended in the vehicle.

When leaving the vehicle, always take the SmartKey with you and lock the vehicle. This also applies to mobile phones if the "Digital Car Key in smartphone" function is activated via the Mercedes me connect web app.

You should preferably place luggage or loads in the cargo compartment. Observe the loading guidelines (▷ page 221).

Unlocking and opening doors from the inside

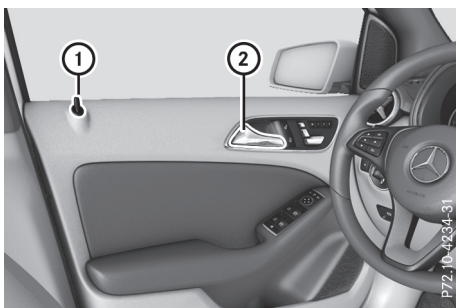

- ▶ **To unlock and open a front door:** pull door handle ②.
If the door is locked, locking knob ① pops up. The door is unlocked and opens.
- ▶ **To unlock a rear door:** pull up locking knob ①.
The door is unlocked and can be opened.
- ▶ **To open a rear door:** pull door handle ②.

You can open a door from inside the vehicle even if it has been locked. You can only open the rear doors from inside the vehicle if they are not secured by the child-proof locks (▷ page 56).

If the vehicle has previously been locked with the SmartKey from the outside, opening a door from the inside will trigger the anti-theft alarm system. Switch off the alarm (▷ page 63).

Centrally locking and unlocking the vehicle from the inside

You can centrally lock or unlock the vehicle from the inside. This can be useful if you wish to lock the vehicle before pulling away, for example.

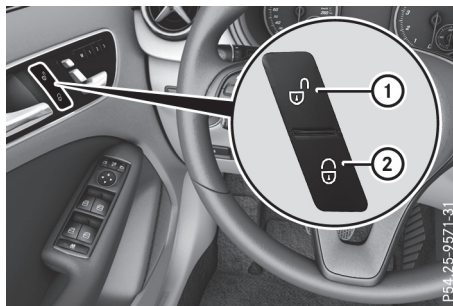

- ▶ **To unlock:** press button ①.
- ▶ **To lock:** press button ②.
If all the doors and the tailgate are closed, the vehicle locks.

Meanwhile, the fuel filler flap will not be locked or unlocked.

You cannot unlock the vehicle centrally from the inside if the vehicle has been locked with the SmartKey or KEYLESS-GO.

You can open a door from inside the vehicle even if it has been locked. You can open the rear doors from inside the vehicle unless they are secured by the child-proof lock (▷ page 56).

If the vehicle has previously been locked with the SmartKey from the outside, opening a door

from the inside will trigger the anti-theft alarm system. Switch off the alarm (▷ page 63).

If a locked door is opened from the inside, the previous unlock status of the vehicle will be taken into consideration if:

- the vehicle was locked using the locking button for the central locking, or
- if the vehicle was locked automatically

The vehicle will be fully unlocked if it had previously been fully unlocked. If only the driver's door had been previously unlocked, only the door which has been opened from the inside is unlocked.

Automatic locking feature

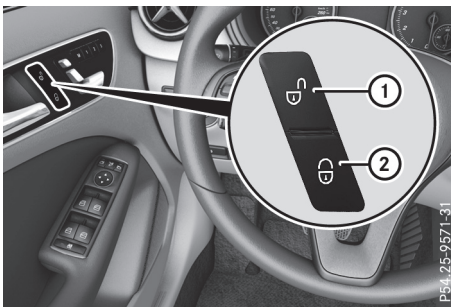

- ▶ **To deactivate:** press and hold button ① for approximately five seconds until a tone sounds.
- ▶ **To activate:** press and hold button ② for approximately five seconds until a tone sounds.

If you press one of the two buttons and do not hear a tone, the relevant setting has already been selected.

The vehicle is locked automatically when the ignition is switched on and the wheels are turning.

You could therefore lock yourself out if:

- the vehicle is being pushed
- the vehicle is being towed
- the vehicle is on a roller dynamometer

You can also switch the automatic locking function on and off using the on-board computer (▷ page 176).

Unlocking the driver's door (mechanical key)

If the vehicle can no longer be locked or unlocked with the SmartKey or KEYLESS-GO, use the mechanical key.

If you use the mechanical key to unlock and open the driver's door, the anti-theft alarm system will be triggered. Switch off the alarm (▷ page 63).

- ▶ Take the mechanical key out of the SmartKey (▷ page 66).
- ▶ Insert the mechanical key into the lock of the driver's door as far as it will go.

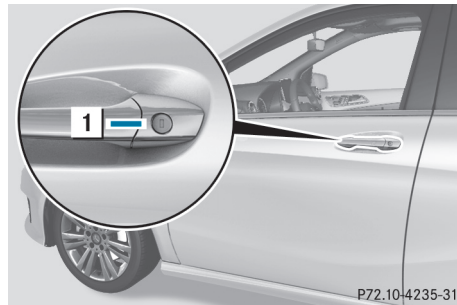

- ▶ Turn the mechanical key counter-clockwise as far as it will go to position 1. The door is unlocked.
- ▶ Turn the mechanical key back and remove it.
- ▶ Insert mechanical key into the SmartKey (▷ page 66).

Locking the vehicle (mechanical key)

If the vehicle can no longer be locked with the SmartKey or KEYLESS-GO, use the mechanical key.

- ▶ Open the driver's door.
- ▶ Close the front-passenger door, the rear doors and the tailgate.
- ▶ Press the locking button on the driver's door (▷ page 70).
- ▶ Check whether the locking knobs on the front-passenger door and the rear doors are still visible. Press down the locking knobs by hand, if necessary.
- ▶ Close the driver's door.

- ▶ Take the mechanical key out of the SmartKey (> page 66).
- ▶ Insert the mechanical key into the lock of the driver's door as far as it will go.

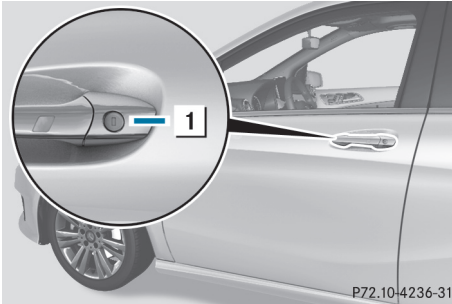

- ▶ Turn the mechanical key clockwise as far as it will go to position **1**.
- ▶ Turn the mechanical key back and remove it.
- ▶ Make sure that the doors and the tailgate are locked.
- ▶ Insert mechanical key into the SmartKey (> page 66).

i If you lock the vehicle as described above, the fuel filler flap is not locked. The anti-theft alarm system is not armed.

Cargo compartment

Important safety notes

⚠ WARNING

Combustion engines emit poisonous exhaust gases such as carbon monoxide. If the tailgate is open when the engine is running, particularly if the vehicle is moving, exhaust fumes could enter the passenger compartment. There is a risk of poisoning.

Turn off the engine before opening the tailgate. Never drive with the tailgate open.

⚠ WARNING

If objects, luggage or loads are not secured or not secured sufficiently, they could slip, tip over or be flung around and thereby hit vehicle occupants. There is a risk of injury, particularly in the event of sudden braking or a sudden change in direction.

Always store objects so that they cannot be flung around. Secure objects, luggage or loads against slipping or tipping before the journey.

! The tailgate swings upwards and to the rear when opened. Therefore, make sure that there is sufficient clearance above and behind the tailgate.

The opening dimensions of the tailgate can be found in the "Vehicle data" section (> page 300).

You should preferably place luggage or loads in the cargo compartment. Observe the loading guidelines (> page 221).

Do not leave the SmartKey in the cargo compartment. You could otherwise lock yourself out.

The tailgate can be:

- opened and closed manually from outside
- released with the emergency release from the inside

Tailgate obstruction detection with reversing feature

On vehicles with an EASY-PACK tailgate, the tailgate is equipped with automatic obstacle recognition with a reversing feature. If a solid object blocks or restricts the tailgate when automatically opening or closing, this procedure is stopped. If the tailgate is stopped during the closing process, the tailgate automatically opens again slightly. The automatic obstruction detection with reversing feature is only an aid. It is not a substitute for your attentiveness when opening and closing the tailgate.

⚠ WARNING

The reversing feature does not respond:

- to soft, light and thin objects, e.g. fingers
- over the last 1/3 in (8 mm) of the closing movement

The reversing feature cannot prevent someone from becoming trapped in these situations in particular. There is a risk of injury.

Make sure that no body parts are in close proximity during the closing procedure.

If somebody becomes trapped:

- press the  button on the SmartKey, or
- pull or press the remote operating switch on the driver's door or
- press the closing button/STOP button in the tailgate or
- pull the handle on the tailgate

Opening and closing manually

Opening

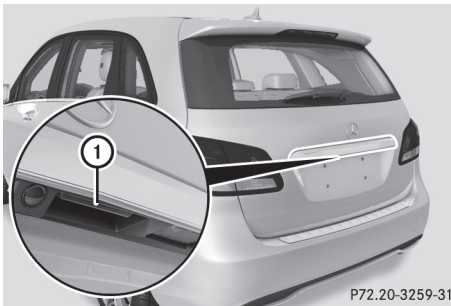

- ▶ Press the  button on the SmartKey.
- ▶ Pull handle ①.
- ▶ Raise the tailgate.

Closing

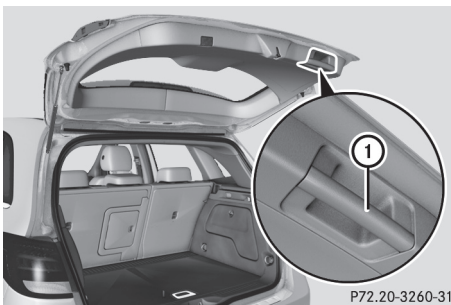

- ▶ Pull the tailgate down using handle ①.
- ▶ Allow the tailgate to drop into the lock.
- ▶ If necessary, lock the vehicle with the  button on the SmartKey or with KEYLESS-GO.

Opening/closing automatically from inside

Important safety notes

WARNING

Parts of the body could become trapped during automatic closing of the tailgate. Moreover, people, e.g. children, may be standing in the closing area or may enter the closing area during the closing process. There is a risk of injury.

Make sure that nobody is in the vicinity of the closing area during the closing process.

Use one of the following options to stop the closing process:

- press the  button on the SmartKey.
- pull or press the remote operating switch on the driver's door.
- press the closing or locking button on the tailgate.
- pull the handle on the tailgate

WARNING

Combustion engines emit poisonous exhaust gases such as carbon monoxide. If the tailgate is open when the engine is running, particularly if the vehicle is moving, exhaust fumes could enter the passenger compartment. There is a risk of poisoning.

Turn off the engine before opening the tailgate. Never drive with the tailgate open.

! The tailgate swings upwards and to the rear when opened. Therefore, make sure that there is sufficient clearance above and behind the tailgate.

The opening dimensions of the tailgate can be found in the "Vehicle data" section (> page 300).

Opening and closing automatically

You can open the tailgate from the driver's seat when the vehicle is stationary and unlocked.

It is only possible to close the tailgate from the driver's seat on vehicles with the EASY-PACK tailgate.

- ▶ **To open:** pull remote operating switch for the tailgate ① until the tailgate opens.
- ▶ **To close:** turn the SmartKey to position ① or ② in the ignition lock (▷ page 114).
- ▶ Press and hold the remote operating switch for tailgate ① until the tailgate is completely closed.

Limiting the opening angle of the tailgate

General notes

- ! Make sure there is sufficient clearance to open the tailgate fully when setting the opening angle. The tailgate could otherwise be damaged. Ideally, set the opening angle outside.

You can limit the opening angle of the tailgate. This could be useful, for example, if there is insufficient space above the tailgate. It is possible to limit the tailgate in the top half of its opening range.

To open the tailgate fully, pull the handle on the outside of the tailgate again after it has stopped automatically. This does not delete the stored position.

Activating

- ▶ **To open the tailgate:** pull the handle on the tailgate.
- ▶ **To stop the opening process at the desired position:**
 - press the closing button in the tailgate, or
 - pull the handle on the outside of the tailgate again, or
 - press the tailgate button on the SmartKey.
- ▶ **To store the position:** press and hold the closing button on the tailgate until you hear a short tone. The opening angle limiter is activated. The tailgate will now stop in the stored position when opening.

Deactivating

- ▶ Press and hold the closing button on the tailgate until two short tones sound.

Tailgate emergency release

General notes

- ! The tailgate swings upwards and to the rear when opened. Therefore, make sure that there is sufficient clearance above and behind the tailgate.

The opening dimensions of the tailgate can be found in the "Vehicle data" section (▷ page 300).

If the tailgate can no longer be unlocked:

- using the SmartKey, or
- using the remote operating switch in the door control panel:

Use the emergency release on the inside of the tailgate.

You can reach the emergency release via the cargo compartment.

Opening

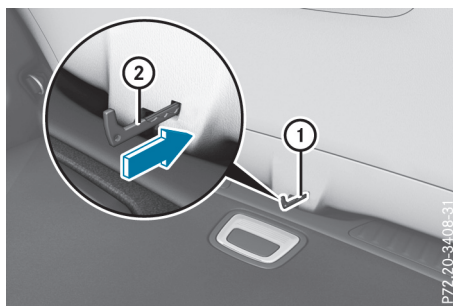

- ▶ Remove cargo compartment cover (▷ page 228).
- ▶ Fold the rear seat backrest forwards (▷ page 225).
- ▶ Take the mechanical key out of the SmartKey (▷ page 66).
- ▶ Insert mechanical key ② into opening ① in the trim and push it in.
- ▶ Open the tailgate.
- ▶ Insert the mechanical key into the SmartKey (▷ page 66).

Emergency release button

You can open the trunk lid from inside the vehicle with the emergency release button.

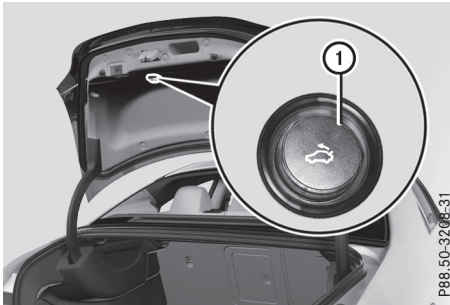

P88.50-320B-31

- ▶ Press emergency release button ① briefly. The trunk lid unlocks and opens.

The trunk lid can be unlocked and opened with the trunk lid emergency release when the vehicle is stationary or while driving.

The trunk lid emergency release does not open the trunk lid if the battery is disconnected or discharged.

Trunk lid emergency release light:

- Emergency release button ① flashes for 30 minutes after the trunk lid is opened.
- Emergency release button ① flashes for 60 minutes after the trunk lid is closed.

Side windows

Important safety notes

WARNING

While opening the side windows, body parts could become trapped between the side window and the door frame as the side window moves. There is a risk of injury.

Make sure that nobody touches the side window during the opening procedure. If somebody becomes trapped, release the switch or pull the switch to close the side window again.

WARNING

While closing the side windows, body parts in the closing area could become trapped. There is a risk of injury.

When closing make sure that no parts of the body are in the closing area. If somebody becomes trapped, release the switch or press the switch to open the side window again.

WARNING

If children operate the side windows they could become trapped, particularly if they are left unsupervised. There is a risk of injury.

Activate the override feature for the rear side windows. When leaving the vehicle, always take the SmartKey with you and lock the vehicle. Never leave children unsupervised in the vehicle.

Side window reversing feature

The side windows are equipped with an automatic reversing feature. If a solid object blocks or restricts a side window from traveling upwards during the automatic closing process, the side window opens again automatically. During the manual closing process, the side window only opens again automatically after the corresponding switch is released. The automatic reversing feature is only an aid and is no substitute for your attention when closing a side window.

WARNING

The reversing feature does not react:

- to soft, light and thin objects, e.g. small fingers
- while resetting

This means that the reversing feature cannot prevent someone being trapped in these situations. There is a risk of injury.

Make sure that no body parts are in close proximity during the closing procedure. If someone becomes trapped, press the switch to open the side window again.

Opening and closing the side windows

The switches for all side windows are located on the driver's door. There is also a switch on each door for the corresponding side window.

The switches on the driver's door take precedence.

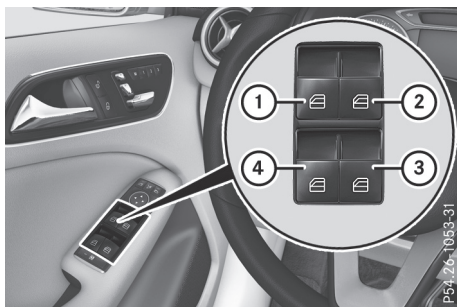

- ① Front left
- ② Front right
- ③ Rear right
- ④ Rear left

▶ Turn the SmartKey to position ① or ② in the ignition lock (▷ page 114).

▶ **To open manually:** press and hold the corresponding switch.

▶ **To open fully:** press the switch beyond the pressure point and release it. Automatic operation is started.

▶ **To close manually:** pull the corresponding switch and hold it.

▶ **To close fully:** pull the switch beyond the pressure point and release it. Automatic operation is started.

▶ **To interrupt automatic operation:** press/pull the corresponding switch again.

i If you press/pull the switch beyond the point of resistance, automatic operation is started in the corresponding direction. You can stop automatic operation by pressing/pulling the switch again.

i You can continue to operate the side windows after you switch off the engine or remove the SmartKey. This function remains active for five minutes or until the driver's or front-passenger door is opened.

i When the override feature for the side windows is activated (▷ page 56), the side windows cannot be operated from the rear.

Convenience opening

Vehicles with KEYLESS-GO or KEYLESS-GO start function: you can ventilate the vehicle before you start driving.

The SmartKey can also be used to carry out the following functions simultaneously:

- unlock the vehicle
- open the side windows
- open the panorama roof with power tilt/sliding panel and the roller sunblind

The convenience opening feature can only be operated using the SmartKey.

The "convenience opening" feature is also available when the vehicle is unlocked.

▶ **Vehicles with KEYLESS-GO or KEYLESS-GO start function:** for the following operations, point the tip of the SmartKey at the handle on the driver's door. The SmartKey must be close to the driver's door handle.

i **Vehicles with KEYLESS-GO or KEYLESS-GO start function:** the SmartKey must be in close proximity to the vehicle.

▶ Press and hold the  button until the side windows and the panorama sunroof are in the desired position.

If the roller sunblind of the panorama roof with power tilt/sliding panel is closed, the roller sunblind is opened first.

▶ Press and hold the  button once more until the panorama roof with power tilt/sliding panel reaches the desired position.

▶ **To interrupt convenience opening:** release the  button.

Convenience closing feature

Important safety notes

WARNING

When the convenience closing feature is operating, parts of the body could become trapped in the closing area of the side window and the sliding sunroof. There is a risk of injury.

Observe the complete closing procedure when the convenience closing feature is operating. Make sure that no body parts are in close proximity during the closing procedure.

Vehicles with KEYLESS-GO or KEYLESS-GO start function: you can do the following at the same time:

- lock the vehicle
- close the side windows
- close the panorama roof with power tilt/sliding panel

On vehicles with a panorama roof with power tilt/sliding panel, you can then close the roller sunblind.

i Notes on the automatic reversing feature for:

- the side window (▷ page 75)
- the panorama roof with power tilt/sliding panel (▷ page 79)
- the roller sunblind (▷ page 81)



Using the SmartKey

▶ **Vehicles with KEYLESS-GO or KEYLESS-GO start function:** for the following operations, point the tip of the SmartKey at the handle on the driver's door. The SmartKey must be close to the driver's door handle.

i **Vehicles with KEYLESS-GO or KEYLESS-GO start function:** the SmartKey must be in close proximity to the vehicle.

- ▶ Press and hold the  button until the side windows and the panorama sliding sunroof are fully closed.
- ▶ Make sure that all the side windows and the panorama roof with power tilt/sliding panel are closed.

On vehicles with a panorama roof with power tilt/sliding panel:

- ▶ Press and hold the  button again until the roller sunblind of the panorama sliding sunroof closes.
- ▶ **To interrupt convenience closing:** release the  button.

Using KEYLESS-GO

The driver's door and the door at which the handle is used, must both be closed. The SmartKey must be outside the vehicle. The gap between the SmartKey and the corresponding door handle should not be greater than 3 ft (1 m).

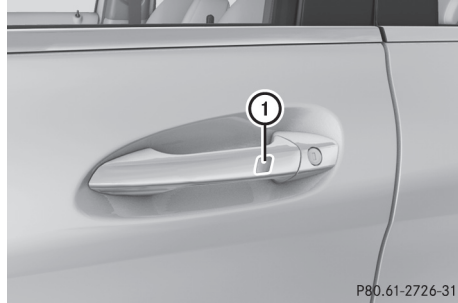

P80.61-2726-31

▶ Touch recessed sensor surface ① on the door handle until the side windows and the panorama roof with power tilt/sliding panel are fully closed.

i Make sure you only touch recessed sensor surface ①.

- ▶ Make sure that all the side windows are closed.
- ▶ Make sure that all the side windows and the panorama roof with power tilt/sliding panel are closed.

On vehicles with a panorama roof with power tilt/sliding panel:

▶ Touch recessed sensor surface ① on the door handle again until the roller sunblind of the panorama roof with power tilt/sliding panel closes.

▶ **To interrupt convenience closing:** release recessed sensor surface ① on the door handle.

Resetting the side windows

If a side window can no longer be closed fully, you must reset it.

- ▶ Close all the doors.
- ▶ Turn the SmartKey to position **1** or **2** in the ignition lock (▷ page 114).
- ▶ Pull the corresponding switch on the door control panel until the side window is completely closed (▷ page 75).
- ▶ Hold the switch for an additional second.

If the side window opens again slightly:

- ▶ Immediately pull the corresponding switch on the door control panel until the side window is completely closed (▷ page 75).
- ▶ Hold the switch for an additional second.
- ▶ If the respective side window remains closed after the button is released, then it has been set correctly. If this is not the case, repeat the steps above.

Problems with the side windows

WARNING

If you close a side window again immediately after it has been blocked or reset, the side window closes with increased or maximum force. The reversing feature is then not active. Parts of the body could be trapped in the closing area in the process. This poses an increased risk of injury or even fatal injury.

Make sure that no parts of the body are in the closing area. To stop the closing process, release the switch or push the switch again to reopen the side window.

| Problem | Possible causes/consequences and ▶ Solutions |
|---|--|
| A side window cannot be closed because it is blocked by objects, e.g. leaves in the window guide. | <ul style="list-style-type: none"> ▶ Remove the objects. ▶ Close the side window. |
| A side window cannot be closed and you cannot see the cause. | <p>If a side window is obstructed during closing and reopens again slightly:</p> <ul style="list-style-type: none"> ▶ Immediately after the window blocks, pull the corresponding switch again until the side window has closed. The side window is closed with increased force. <p>If a side window is obstructed again during closing and reopens again slightly:</p> <ul style="list-style-type: none"> ▶ Immediately after the window blocks, pull the corresponding switch again until the side window has closed. The side window is closed without the automatic reversing feature. |
| The side windows cannot be opened or closed using the convenience opening/closing feature. | <p>The SmartKey battery is discharged or nearly discharged.</p> <ul style="list-style-type: none"> ▶ Check the SmartKey battery (▷ page 67) and replace it if necessary (▷ page 67). |

Panorama roof with power tilt/sliding panel

Important safety notes

In the following section, the term "sliding sunroof" refers to the panorama roof with power tilt/sliding panel.

WARNING

While opening and closing the sliding sunroof, body parts in close proximity could become trapped. There is a risk of injury.

Make sure that no body parts are in close proximity during the opening and closing procedures.

If somebody becomes trapped:

- release the switch immediately, or
- during automatic operation, push the switch briefly in any direction

The opening or closing procedure will be stopped.

WARNING

If children operate the sliding sunroof they could become trapped, particularly if they are left unsupervised. There is a risk of injury.

When leaving the vehicle, always take the SmartKey with you and lock the vehicle. Never leave children unsupervised in the vehicle.

! Only open the sliding sunroof if it is free of snow and ice. Otherwise, malfunctions may occur.

Do not allow anything to protrude from the sliding sunroof. Otherwise, the seals could be damaged.

! The weather can change abruptly. It could start to rain or snow. Make sure that the sliding sunroof is closed when you leave the vehicle. The vehicle electronics can be damaged if water enters the vehicle interior.

i Resonance noises can occur in addition to the usual airflow noises when the sliding sunroof is open. They are caused by minor pressure fluctuations in the vehicle interior. Change the position of the sliding sunroof or open a side window slightly to reduce or eliminate these noises.

Sliding sunroof reversing feature

In the following section, the term "sliding sunroof" refers to the panorama roof with power tilt/sliding panel.

The sliding sunroof is equipped with an automatic reversing feature. If a solid object blocks or restricts the sliding sunroof during the closing process, the sliding sunroof opens again automatically. However, the automatic reversing feature is only an aid and does not relieve you of the responsibility of paying attention when closing the sliding sunroof.

WARNING

The reversing feature does not react:

- to soft, light and thin objects, e.g. small fingers
- over the last 1/6 in (4 mm) of the closing movement
- during resetting
- when closing the sliding sunroof again manually immediately after automatic reversing

This means that the reversing feature cannot prevent someone being trapped in these situations. There is a risk of injury.

Make sure that no body parts are in close proximity during the closing procedure.

If somebody becomes trapped:

- release the switch immediately, or
- press the switch in any direction during the automatic closing process

The closing process is stopped.

Operating the panorama roof with power tilt/sliding panel

Opening and closing

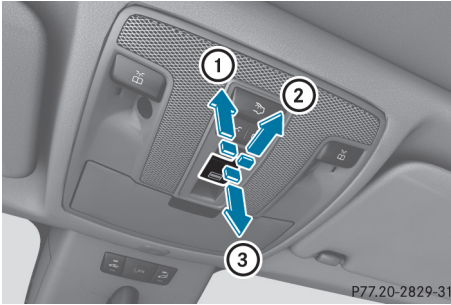

- ① To raise
- ② To open
- ③ To close/lower

The panorama roof with power tilt/sliding panel can only be operated when the roller sunblind is open.

- ▶ Turn the SmartKey to position **1** or **2** in the ignition lock (> page 114).
- ▶ Press or pull the  switch in the corresponding direction.

If you press/pull the  switch beyond the point of resistance, automatic operation is started in the corresponding direction. You can stop automatic operation by pressing/pulling the switch again.

You can continue to operate the sliding sunroof after switching off the engine or removing the SmartKey from the ignition lock. This function remains active for five minutes or until you open a front door.

The sliding sunroof cannot be opened if a roof carrier is installed. In order to allow ventilation of the vehicle interior, you can raise the sliding sunroof.

If contact is made with a roof carrier approved by Mercedes-Benz, the sliding sunroof lowers slightly but remains raised at the rear.

Rain-closing feature

The rain-closing feature is only available for vehicles with a rain sensor.

When the SmartKey is in position **0** in the ignition lock or is removed, the sliding sunroof closes automatically:

- if it starts to rain.
- at extreme outside temperatures.
- after six hours.
- if there is a malfunction in the power supply.

The panorama roof with power tilt/sliding panel remains raised at the rear in order to allow ventilation of the vehicle interior.

If the panorama roof with power tilt/sliding panel is obstructed while being closed by the rain-closing feature, it opens again slightly. The rain-closing feature is then deactivated.

The panorama roof with power tilt/sliding panel does not close if:

- it is raised at the rear.
- it is blocked.
- no rain is falling on the area of the windshield being monitored by the rain sensor. If the vehicle, for example, is under a bridge or in a carport, the field of the sensor may be covered.

Operating the roller sunblind for the panorama roof with power tilt/sliding panel

Important safety notes

WARNING

Parts of the body could become trapped between the roller sunblind and frame or sliding sunroof during automatic opening or closing. There is a risk of injury.

When opening or closing, make sure that no body parts are in the sweep of the roller sunblind.

If somebody becomes trapped:

- release the switch immediately, or
- during automatic operation, push the switch briefly in any direction

The opening or closing procedure will be stopped.

The roller sunblind shields the vehicle interior from sunlight. The roller sunblind can only be

opened and closed when the panorama roof with power tilt/sliding panel is closed.

Roller sunblind reversing feature

The roller sunblind is equipped with an automatic reversing feature. If a solid object blocks or restricts the roller sunblind during the closing process, the roller sunblind opens again automatically. The automatic reversing feature is only an aid and is not a substitute for your attentiveness when closing the roller sunblind.

WARNING

The reversing feature does not react:

- to soft, light and thin objects, e.g. small fingers
- when closing the roller sunblind again manually immediately after automatic reversal

This means that the reversing feature cannot prevent someone being trapped in these situations. There is a risk of injury.

When closing the roller sunblind, make sure that no body parts are in the sweep area.

If somebody becomes trapped:

- release the switch immediately, or
- press the switch in any direction during the automatic closing process

The closing process is stopped.

Opening and closing

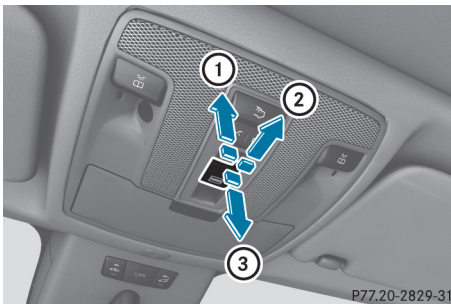

- ① Opens
- ② Opens
- ③ Closes

- ▶ Turn the SmartKey to position ① or ② in the ignition lock (▷ page 114).
- ▶ Press or pull the  switch in the corresponding direction.



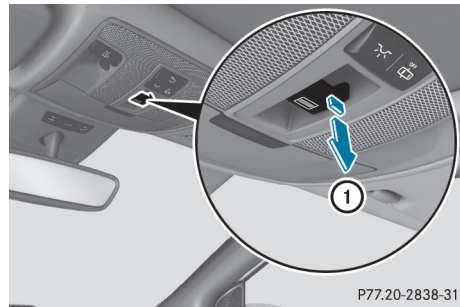

If you press/pull the  switch beyond the point of resistance, automatic operation is started in the corresponding direction. You can stop automatic operation by pressing/pulling the switch again.

After opening the panorama roof with power tilt/sliding panel, the roller sunblind automatically closes slightly. This reduces drafts in the vehicle interior.

Resetting the panorama roof with power tilt/sliding panel or the roller sunblind



Reset the panorama roof with power tilt/sliding panel or the roller sunblind if the panorama roof with power tilt/sliding panel or the roller sunblind does not move smoothly.

- ▶ Turn the SmartKey to position ① or ② in the ignition lock (▷ page 114).
- ▶ Pull the  switch repeatedly to the point of resistance in the direction of arrow ① until the panorama roof with power tilt/sliding panel is fully closed.
- ▶ Keep the  switch pulled for an additional second.
- ▶ Pull the  switch repeatedly to the point of resistance in the direction of arrow ① until the roller sunblind is fully closed.
- ▶ Keep the  switch pulled for an additional second.
- ▶ Make sure that the panorama roof with power tilt/sliding panel and the roller sunblind can be fully opened and closed again.
- ▶ If this is not the case, repeat the steps above.



Problems with the panorama roof with power tilt/sliding panel

WARNING

If you do not reset the sliding sunroof after a malfunction or voltage supply interruption, then the backing up function will malfunction or not work. The sliding sunroof closes with increased or maximum force. Parts of the body could be trapped in the closing area in the process. This poses an increased risk of injury or even fatal injury.

In such or similar situations always make sure that no parts of the body are in the closing area. Always reset the sliding sunroof after a malfunction or voltage supply interruption.

! If the sliding sunroof still cannot be opened or closed as a result of a malfunction, contact a qualified specialist workshop.

| Problem | Possible causes/consequences and ► Solutions |
|--|---|
| The panorama roof with power tilt/sliding panel cannot be closed and you cannot see the cause. | <p>If the panorama roof with power tilt/sliding panel is obstructed during closing and reopens again slightly:</p> <ul style="list-style-type: none"> ► Immediately after it blocks, pull the  switch down again to the point of resistance until the panorama roof with power tilt/sliding panel is closed. The panorama roof with power tilt/sliding panel is closed with more force. <p>If the panorama roof with power tilt/sliding panel is obstructed again during closing and reopens again slightly:</p> <ul style="list-style-type: none"> ► Immediately after it blocks, pull the  switch down again to the point of resistance until the panorama roof with power tilt/sliding panel is closed. The panorama roof with power tilt/sliding panel is closed without the automatic reversing feature. |
| The panorama sliding sunroof cannot be opened or closed using the convenience opening/closing feature. | <p>The SmartKey battery is discharged or nearly discharged.</p> <ul style="list-style-type: none"> ► Check the SmartKey battery (▷ page 67) and replace it if necessary (▷ page 67). |

Correct driver's seat position

WARNING

You could lose control of your vehicle if you do the following while driving:

- adjust the driver's seat, head restraint, steering wheel or mirrors
- fasten the seat belt

There is a risk of an accident.

Adjust the driver's seat, head restraint, steering wheel and mirror and fasten your seat belt before starting the engine.



P9140-34-31

Observe the following when adjusting steering wheel ①, seat belt ② and driver's seat ③:

- you are as far away from the driver's air bag as possible
- you are sitting in a normal upright position
- your thighs are slightly supported by the seat cushion
- your legs are not entirely stretched and you can depress the pedals properly
- the back of your head is supported at eye level by the center of the head restraint
- you can hold the steering wheel with your arms slightly bent
- you can move your legs freely
- you can see all the displays in the instrument cluster clearly

- you should have a good overview of traffic conditions
- the seat belt is pulled snugly against the body and is routed across the center of your shoulder and across your hips in the pelvic area

Further related subjects:

- Adjusting the seats manually (▷ page 84)
- Adjusting the seats electrically (▷ page 85)
- Adjusting the steering wheel manually (▷ page 88)
- Fastening the seat belt correctly (▷ page 41)
- Adjusting the rear-view mirror and exterior mirrors (▷ page 89)
- **Vehicles with a memory function:** saving the seat, steering wheel and exterior mirror settings using the memory function (▷ page 91)

Seats

Important safety notes

WARNING

Children could become trapped if they adjust the seats, particularly when unattended.

There is a risk of injury.

When leaving the vehicle, always take the SmartKey with you and lock the vehicle. Never leave children unsupervised in the vehicle.

The seats can still be adjusted when there is no SmartKey in the ignition lock.

WARNING

When you adjust a seat, you or other vehicle occupants could become trapped, e.g. on the seat guide rail. There is a risk of injury.

Make sure when adjusting a seat that no one has any body parts in the sweep of the seat.

WARNING

If the driver's seat is not engaged, it could move forwards as far as the next catch during movement such as braking or abrupt changes of direction. As a result, you would be pushed

against your seat belt by the unsecured driver's seat.

This could cause you to lose control of the vehicle. The seat belt cannot protect as intended and could result in additional injury.

There is a risk of an accident and injury.

Before every journey, make sure that the driver's seat is fully engaged.

Observe the safety notes on "Air bags" (▷ page 42) and "Children in the vehicle" (▷ page 50).

WARNING

If the driver's seat is not engaged, it could move unexpectedly while the vehicle is in motion. This could cause you to lose control of the vehicle. There is a risk of an accident.

Always make sure that the driver's seat is engaged before starting the vehicle.

WARNING

You could lose control of your vehicle if you do the following while driving:

- adjust the driver's seat, head restraint, steering wheel or mirrors
- fasten the seat belt

There is a risk of an accident.

Adjust the driver's seat, head restraint, steering wheel and mirror and fasten your seat belt before starting the engine.

WARNING

If you adjust the seat height carelessly, you or other vehicle occupants could be trapped and thereby injured. Children in particular could accidentally press the electrical seat adjustment buttons and become trapped. There is a risk of injury.

While moving the seats, make sure that your hands or other body parts do not get under the lever assembly of the seat adjustment system.

 To prevent damage to the seats and the seat heating, observe the following notes:

- Do not spill liquids onto the seats. Dry the seats as soon as possible if liquid does get spilled on the seats.
- If the seat covers are damp or wet, do not switch on the seat heating. Also, do not use the seat heating to dry the seats.
- Clean the seat covers as recommended; see the "Interior care" section.
- Do not transport heavy loads on the seats. Do not place pointed objects on the seat cushions such as knives, nails or tools. Where possible, use the seats only for carrying passengers.
- When operating the seat heating, do not cover the seats with insulating materials, e.g. blankets, coats, bags, protective covers, child seats or booster seats.
- When the seat heating is switched on, the seat surface can be damaged as a result of objects being placed on the seats; for example, seat cushions, child seats and protective covers not approved by Mercedes-Benz.

 Make sure that there are no objects in the footwell under or behind the seats when moving the seats back. There is a risk that the seats and/or the objects could be damaged.

 Further related subjects:

- Cargo compartment enlargement (folding down the rear seats) (▷ page 224)

Adjusting the seats manually

Vehicles without the seating comfort package



Seat fore-and-aft adjustment:

- ▶ Lift handle ① and slide the seat forwards or backwards.
- ▶ Release lever ① again.
Make sure that you hear the seat engage in position.

Backrest angle:

- ▶ Relieve the pressure on the backrest.
- ▶ Turn handwheel ③ forwards or backwards.

Seat height:

- ▶ Pull handle ② upwards or push it down repeatedly until the seat has reached the desired height.

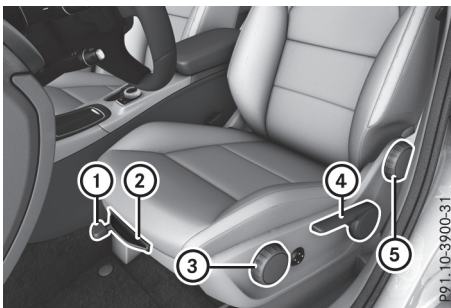
Vehicles with the seating comfort package**Seat fore-and-aft adjustment:**

- ▶ Lift handle ① and slide the seat forwards or rearwards.
- ▶ Release lever ① again.
Make sure that you hear the seat engage in position.

Backrest angle:

- ▶ Relieve the pressure on the backrest.
- ▶ Turn handwheel ⑤ forwards or backwards.

Seat height:

- ▶ Pull handle ④ upwards or push it down repeatedly until the seat has reached the desired height.

Seat cushion angle:

- ▶ Adjust the angle so that your thighs are lightly supported.
- ▶ Turn handwheel ③ forwards or backwards.

Seat cushion length:

- ▶ Lift handle ② and slide the front part of the seat cushion forwards or backwards.
- ▶ Release lever ② again.
The seat cushion engages.

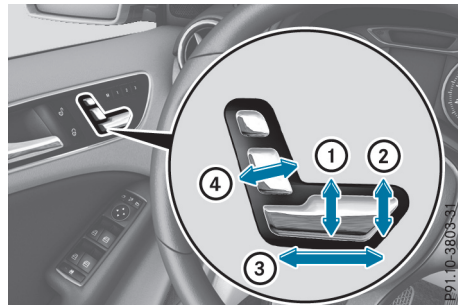
Adjusting the seats electrically

- ① Seat height
- ② Seat cushion angle
- ③ Seat fore-and-aft adjustment
- ④ Backrest angle

- ❗ You can store the seat settings using the memory function (▶ page 91).

Adjusting the head restraints**Important safety notes****⚠ WARNING**

You could lose control of your vehicle if you do the following while driving:

- adjust the driver's seat, head restraint, steering wheel or mirrors
- fasten the seat belt

There is a risk of an accident.

Adjust the driver's seat, head restraint, steering wheel and mirror and fasten your seat belt before starting the engine.

⚠ WARNING

If the head restraints are not installed or not adjusted correctly, they cannot provide protection as intended. There is an increased risk

of injury in the head and neck area, e.g. in the event of an accident or when braking.

Always drive with the head restraints installed. Before driving off, make sure for every vehicle occupant that the center of the head restraint supports the back of the head at about eye level.

Using the fore-and-aft adjustment, adjust the head restraint so that it is as close as possible to your head.

Adjusting the head restraints manually

Adjusting the head restraint height

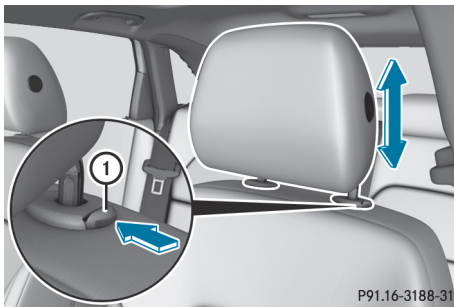

P91.16-3188-31

- ▶ **To raise:** pull the head restraint up to the desired position.
- ▶ **To lower:** press release catch ① in the direction of the arrow and push the head restraint down to the desired position.

Adjusting the fore/aft position of the head restraint

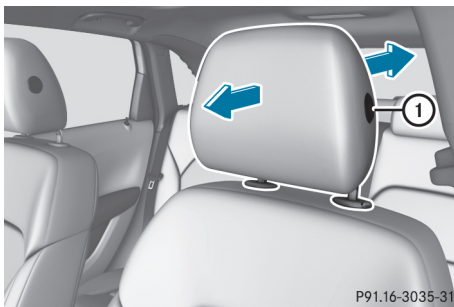

P91.16-3035-31

With this function you can adjust the distance between the head restraint and the back of the seat occupant's head.

- ▶ **To move forwards:** pull the head restraint forwards in the direction of the arrow until it engages. There are several notches.
- ▶ **To move backwards:** press and hold release button ① and push the head restraint backwards.
- ▶ When the head restraint is in the desired position, release the button and make sure that the head restraint is engaged in position.

Rear seat head restraints

Adjusting the rear seat head restraint height

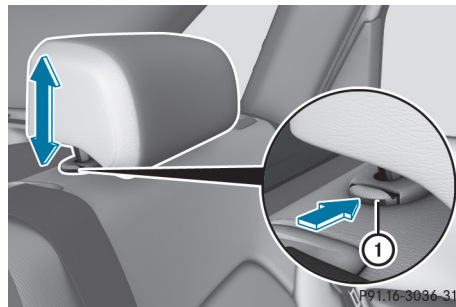

P91.16-3086-31

- ▶ **To raise:** pull the head restraint up to the desired position.
- ▶ **To lower:** press release catch ① and push the head restraint down until it is in the desired position.

Adjusting the 4-way lumbar support

You can adjust the contour of the front seat backrests individually to provide optimum support for your back.

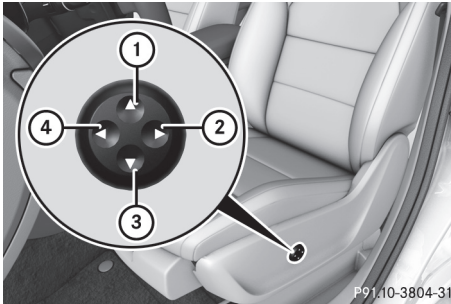

P91.10-3804-31

- ① Raises the backrest contour
- ② Softens the backrest contour
- ③ Lowers the backrest contour
- ④ Hardens the backrest contour

Switching the seat heating on/off

Switching on/off

⚠ WARNING

Repeatedly switching on the seat heating can cause the seat cushion and backrest pads to become very hot. The health of persons with limited temperature sensitivity or a limited ability to react to high temperatures may be affected or they may even suffer burn-like injuries. There is a risk of injury.

Therefore, do not switch the seat heating on repeatedly.

! When the seat heating is switched on, the seat surface can be damaged as a result of objects being placed on the seats; for exam-

ple, seat cushions, child seats and protective covers not approved by Mercedes-Benz.

When the seat heating is switched on, ensure that there are no objects on the seats.



P91.30-2636-31

The three red indicator lamps in the button indicate the heating level you have selected.

The system automatically switches down from level 3 to level 2 after approximately eight minutes.

The system automatically switches down from level 2 to level 1 after approximately ten minutes.

The system automatically switches off approximately 20 minutes after it is set to level 1.

- ▶ Turn the SmartKey to position ① or ② in the ignition lock (▷ page 114).
- ▶ **To switch on:** press button ① repeatedly until the desired heating level is set.
- ▶ **To switch off:** press button ① repeatedly until all the indicator lamps go out.

i If the battery voltage is too low, the seat heating may switch off.

Problems with the seat heating

| Problem | Possible causes/consequences and ► Solutions |
|---|--|
| The seat heating has switched off prematurely or cannot be switched on. | The on-board voltage is too low because too many electrical consumers are switched on. ► Switch off electrical consumers that you do not need, such as the rear window defroster or interior lighting. Once the battery is sufficiently charged, the seat heating will switch back on automatically. |

Steering wheel

Important safety notes

WARNING

You could lose control of your vehicle if you do the following while driving:

- adjust the driver's seat, head restraint, steering wheel or mirrors
- fasten the seat belt

There is a risk of an accident.

Adjust the driver's seat, head restraint, steering wheel and mirror and fasten your seat belt before starting the engine.

WARNING

Children could injure themselves if they adjust the steering wheel. There is a risk of injury.

When leaving the vehicle, always take the SmartKey with you and lock the vehicle. This also applies to mobile phones if the "Digital Car Key in smartphone" function is activated via the Mercedes me connect web app. Never leave children unsupervised in the vehicle.

Adjusting the steering wheel

WARNING

If the steering wheel is unlocked while the vehicle is in motion, it could change position unexpectedly. This could cause you to lose control of the vehicle. There is a risk of an accident.

Before starting off, make sure the steering wheel is locked. Never unlock the steering wheel while the vehicle is in motion.

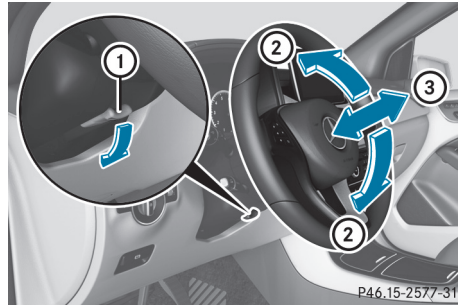

- ① Release lever
- ② Adjusts the steering wheel height
- ③ Adjusts the steering wheel position (fore-and-aft adjustment)

- ▶ Push release lever ① down completely. The steering column is unlocked.
- ▶ Adjust the steering wheel to the desired position.
- ▶ Push release lever ① up completely. The steering column is locked.
- ▶ Check if the steering column is locked. When doing so, try to push the steering wheel up or down or try to move it in the fore-and-aft direction.

Mirrors

Rear-view mirror



- ▶ **Anti-glare mode:** flick anti-glare lever ① forwards or back.

Exterior mirrors

Adjusting the exterior mirrors

WARNING

You could lose control of your vehicle if you do the following while driving:

- adjust the driver's seat, head restraint, steering wheel or mirrors
- fasten the seat belt

There is a risk of an accident.

Adjust the driver's seat, head restraint, steering wheel and mirror and fasten your seat belt before starting the engine.

WARNING

The exterior mirror on the front-passenger side reduces the size of the image. Visible objects are actually closer than they appear. This means that you could misjudge the distance from road users traveling behind, e.g. when changing lane. There is a risk of an accident.

For this reason, always make sure of the actual distance from the road users traveling behind by glancing over your shoulder.

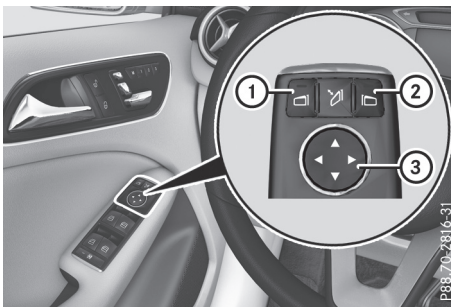

- ▶ Turn the SmartKey to position **1** or **2** in the ignition lock (▷ page 114).
- ▶ Exterior mirror on the front-passenger side: press button **2**.

Exterior mirror on the driver's side: press button **1**.

The indicator lamp in the corresponding button lights up in red.

The indicator lamp goes out again after some time. You can adjust the selected exterior

mirror using button **3** as long as the indicator lamp is lit.

- ▶ Press button **3** up, down, or to the right or left until you have adjusted the exterior mirror to the correct position. You should have a good overview of traffic conditions.

The convex exterior mirrors provide a larger field of vision.

After the engine has been started, the exterior mirrors are automatically heated at low outside temperatures. Heating takes a maximum of ten minutes.

- i** You can also heat up the exterior mirrors manually by switching on the rear window defroster.

Folding the exterior mirrors in or out electrically

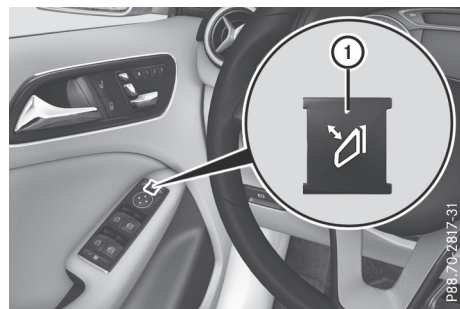

- ▶ Turn the SmartKey to position **1** or **2** in the ignition lock (▷ page 114).
- ▶ Briefly press **1**. Both exterior mirrors fold in or out.

- i** Make sure that the exterior mirrors are always folded out fully while driving. They could otherwise vibrate.
- i** If you are driving faster than 30 mph (47 km/h), you can no longer fold in the exterior mirrors.

Resetting the exterior mirrors

If the battery has been disconnected or completely discharged, the exterior mirrors must be reset. The exterior mirrors will otherwise not fold in when you select the "Fold in mirrors when locking" function in the on-board computer (▷ page 176).

- ▶ Turn the SmartKey to position **1** in the ignition lock (▷ page 114).
- ▶ Briefly press **1**.

Folding the exterior mirrors in or out automatically

If the "Fold in mirrors when locking" function is activated in the on-board computer (▷ page 176):

- the exterior mirrors fold in automatically as soon as you lock the vehicle from the outside.
- the exterior mirrors fold out again automatically as soon as you unlock the vehicle and then open the driver's or front-passenger door.

i If the exterior mirrors have been folded in manually, they do not fold out.

Exterior mirror pushed out of position

If an exterior mirror has been pushed out of position, proceed as follows:

- ▶ **Vehicles without electrically folding exterior mirrors:** move the exterior mirror into the correct position manually.
- ▶ **Vehicles with electrically folding exterior mirrors:** press and hold mirror-folding button (▷ page 89) until you hear the mirror click into place.
The mirror housing is engaged again and you can adjust the exterior mirrors as usual (▷ page 89).

Automatic anti-glare mirrors

WARNING

Electrolyte may escape if the glass in an automatic anti-glare mirror breaks. The electrolyte is harmful and causes irritation. It must not come into contact with your skin, eyes, respiratory organs or clothing or be swallowed. There is a risk of injury.

If you come into contact with the electrolyte, observe the following:

- Rinse off the electrolyte from your skin immediately with water.
- Immediately rinse the electrolyte out of your eyes thoroughly with clean water.
- If the electrolyte is swallowed, immediately rinse your mouth out thoroughly. Do not induce vomiting.
- If electrolyte comes into contact with your skin or hair or is swallowed, seek medical attention immediately.
- Immediately change out of clothing which has come into contact with electrolyte.
- If an allergic reaction occurs, seek medical attention immediately.

The "Automatic anti-glare mirrors" function is only available if the vehicle is equipped with the "Mirrors package".

The rear-view mirror and the exterior mirror on the driver's side automatically go into anti-glare mode if:

- the ignition is switched on and
- incident light from headlamps strikes the sensor in the rear-view mirror

The mirrors do not go into anti-glare mode if reverse gear is engaged or if the interior lighting is switched on.

Parking position for the exterior mirror on the front-passenger side

Setting and storing the parking position

You can set the front-passenger side exterior mirror such that you can see the rear wheel on that side as soon as you engage reverse gear. You can store this position.

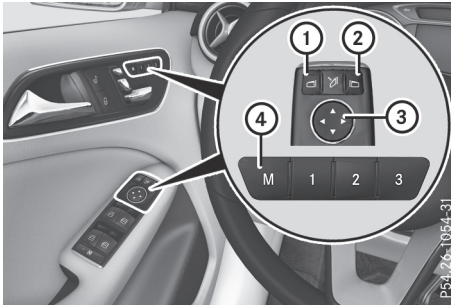

- ① Button for the driver's side exterior mirror
- ② Button for the front-passenger side exterior mirror
- ③ Button for the exterior mirror setting
- ④ Memory button **M**

- ▶ Make sure that the vehicle is stationary.
- ▶ Turn the SmartKey to position **2** in the ignition lock or start the engine (▷ page 114).
- ▶ Press button ②.
- ▶ Engage reverse gear.
The exterior mirror on the front-passenger side moves to the default parking position.
- ▶ Use button ③ to adjust the exterior mirror to a position that allows you to see the rear wheel and the curb.
The parking position is stored.

i If you shift the transmission to another position, the front-passenger side exterior mirror returns to the driving position.

Calling up a stored parking position setting

- ▶ Turn the SmartKey to position **2** in the ignition lock (▷ page 114).
- ▶ Adjust the front-passenger side exterior mirror using the corresponding button (▷ page 89).
- ▶ Engage reverse gear.
The exterior mirror on the front-passenger side moves to the stored parking position.

The exterior mirror on the front-passenger side moves back to its original position:

- as soon as you exceed a speed of 9 mph (15 km/h)
- about ten seconds after you have disengaged reverse gear
- when you use button ① to select the exterior mirror on the driver's side

Memory function

Important safety notes

⚠ WARNING

If you use the memory function on the driver's side while driving, you could lose control of the vehicle as a result of the adjustments being made. There is a risk of an accident. Only use the memory function on the driver's side when the vehicle is stationary.

⚠ WARNING

When the memory function adjusts the seat, you and other vehicle occupants – particularly children – could become trapped. There is a risk of injury.

While the memory function is making adjustments, make sure that no one has any body parts in the sweep of the seat. If somebody becomes trapped, immediately release the memory function position button. The adjustment process is stopped.

⚠ WARNING

Children could become trapped if they activate the memory function, particularly when unattended. There is a risk of injury.

When leaving the vehicle, always take the SmartKey with you and lock the vehicle. This also applies to mobile phones if the "Digital Car Key in smartphone" function is activated via the Mercedes me connect web app. Never leave children unsupervised in the vehicle.

The memory function can be used at any time, e.g. even when the SmartKey is not in the ignition lock.

Storing settings

With the memory function, you can store up to three different settings, e.g. for three different people.

The following settings are stored as a single memory preset:

- seat and backrest position
- driver's side: position of the exterior mirrors on the driver's and front-passenger sides

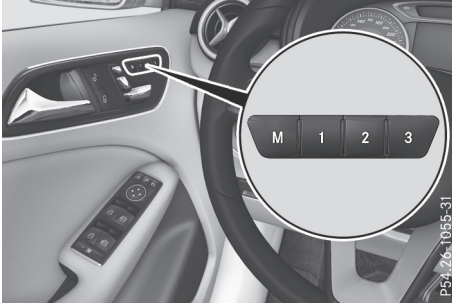

- ▶ Adjust the seat (▷ page 85).
- ▶ Adjust the exterior mirror on the driver's side (▷ page 89).
- ▶ Briefly press the **M** memory button and then press preset position button **1**, **2** or **3** within three seconds.
The settings are stored in the selected preset position. A tone sounds when the settings have been completed.

Calling up a stored setting

- ▶ Press and hold the relevant preset position button **1**, **2** or **3** until the seat and exterior mirrors are in the stored position.
- i** The setting procedure is interrupted as soon as you release the storage position button.

Exterior lighting

General notes

For reasons of safety, Mercedes-Benz recommends that you drive with the lights switched on even during the daytime. In some countries, operation of the headlamps varies due to legal requirements and self-imposed obligations.

Setting the exterior lighting

Setting options

Exterior lighting can be set using the:

- light switch
- combination switch (> page 94)

Light switch

Operation

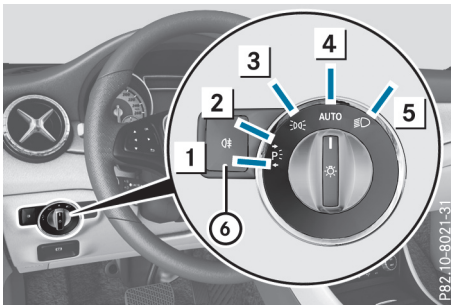

- 1 Left-hand standing lamps
- 2 Right-hand standing lamps
- 3 Parking lamps, license plate and instrument cluster lighting
- 4 **AUTO** Automatic headlamp mode, controlled by the light sensor
- 5 Low-beam/high-beam headlamps
- 6 Rear fog lamp

If you hear a warning tone when you leave the vehicle, the lights may still be switched on.

- ▶ Turn the light switch to the **AUTO** position.

The exterior lighting (except the parking/standing lamps) switches off automatically if you:

- remove the SmartKey from the ignition lock
- open the driver's door with the SmartKey in position **0**

Automatic headlamp mode

AUTO is the preferred light switch position:

- The light setting is automatically selected according to the brightness of the ambient light (exception: poor visibility due to weather conditions such as fog, snow or spray).
- With the SmartKey in position **1** in the ignition lock: the parking lamps are switched on or off automatically depending on the brightness of the ambient light.
- With the engine running: if you have activated the **Daytime Running Lights** function via the on-board computer, the daytime running lamps or the parking lamps and the low-beam headlamps are switched on or off automatically depending on the brightness of the ambient light.

- ▶ **To switch on the automatic headlamp mode:** turn the light switch to the **AUTO** position.

WARNING

When the light switch is set to **AUTO**, the low-beam headlamps may not be switched on automatically if there is fog, snow or other causes of poor visibility due to the weather conditions such as spray. There is a risk of an accident.

In such situations, turn the light switch to .

The automatic headlamp feature is only an aid. The driver is responsible for the vehicle's lighting at all times.

The daytime running lamps improve the visibility of your vehicle during the day. The daytime running lamps function is required by law in Canada. It cannot therefore be deactivated.



When the engine is running and the vehicle is stationary: if you move the selector lever from a driving position to position **P**, the daytime running lamps/low-beam headlamps go out after three minutes.

When the engine is running, the vehicle is stationary and in bright ambient light: if you turn the light switch to the position, the daytime running lamps and parking lamps turn on.

If the engine is running and you turn the light switch to the position, the manual settings take precedence over the daytime running lamps.







Low-beam headlamps

Even if the light sensor does not detect that it is dark, the parking lamps and low-beam headlamps switch on when the ignition is switched on and the light switch is set to the  position. This is a particularly useful function in the event of rain and fog.



- ▶ **To switch on the low-beam headlamps:** turn the SmartKey to position  in the ignition lock or start the engine.
- ▶ Turn the light switch to . The green  indicator lamp in the instrument cluster lights up.



Rear fog lamp

The rear fog lamp improves visibility of your vehicle for the traffic behind in the event of thick fog. Please take note of the country-specific regulations for the use of rear fog lamps.

- ▶ **To switch on the rear fog lamp:** turn the SmartKey in the ignition lock to position  or start the engine.
- ▶ Turn the light switch to  or **AUTO**.
- ▶ Press the  button. The yellow  indicator lamp in the instrument cluster lights up.
- ▶ **To switch off the rear fog lamp:** press the  button. The yellow  indicator lamp in the instrument cluster goes out.



Parking lamps

! If the battery charge is very low, the parking lamps or standing lamps are automatically switched off to enable the next engine start. Always park your vehicle safely and in a well lit area, in accordance with the relevant legal stipulations. Avoid using the  parking lamps over a period of several hours. If possible, switch on the right-hand  or left-hand  standing lamps.

- ▶ **To switch on:** turn the light switch to . The green  indicator lamp in the instrument cluster lights up.







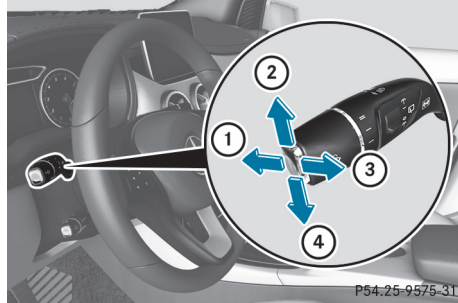

Standing lamps

Switching on the standing lamps ensures the corresponding side of the vehicle is illuminated.

- ▶ **To switch on the standing lamps:** the SmartKey is not in the ignition lock or it is in position  in the ignition lock.
- ▶ Turn the light switch to  (left-hand side of the vehicle) or  (right-hand side of the vehicle).

Combination switch



- ▶ **To indicate briefly:** press the combination switch briefly to the pressure point in the direction of arrow  or . The corresponding turn signal flashes three times.
- ▶ **To indicate:** press the combination switch beyond the pressure point in the direction of arrow  or .
- ▶ **To switch on the high-beam headlamps:** turn the light switch to  or **AUTO**.
- ▶ Press the combination switch beyond the pressure point in the direction of arrow . The high-beam headlamps only switch on in the **AUTO** position if the low-beam headlamps are on. The blue  indicator lamp in the instrument cluster lights up when the high-beam headlamps are switched on.
- ▶ **To switch off the high-beam headlamps:** move the combination switch back to its normal position. The blue  indicator lamp in the instrument cluster goes out.
- ▶ **To switch on the high-beam flasher:** pull the combination switch in the direction of arrow .

Hazard warning lamps



- ▶ **To switch on the hazard warning lamps:** press button ①. All turn signals flash. If you now switch on a turn signal using the combination switch, only the turn signal lamp on the corresponding side of the vehicle will flash.
- ▶ **To switch off the hazard warning lamps:** press button ①.

The hazard warning lamps automatically switch on if:

- an air bag is deployed or
- the vehicle decelerates rapidly from a speed of above 45 mph (70 km/h) and comes to a standstill

The hazard warning lamps switch off automatically if the vehicle reaches a speed of above 6 mph (10 km/h) again after a full brake application.

The hazard warning lamps still operate if the ignition is switched off.

Headlamps fogged up on the inside

Certain climatic and physical conditions may cause moisture to form in the headlamp. This moisture does not affect the functionality of the headlamp.

Interior lighting

Overview of interior lighting

Front overhead control panel

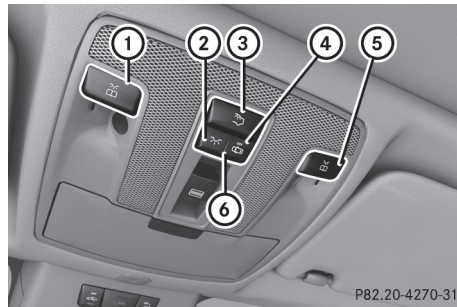

- ① Switches the left-hand front reading lamp on or off
- ② Switches the front interior lighting on
- ③ Switches the rear interior lighting on or off
- ④ Switches the front interior lighting/automatic interior lighting control off
- ⑤ Switches the right-hand front reading lamp on or off
- ⑥ Switches the automatic interior lighting control on

Control panel in the grab handle in the rear compartment

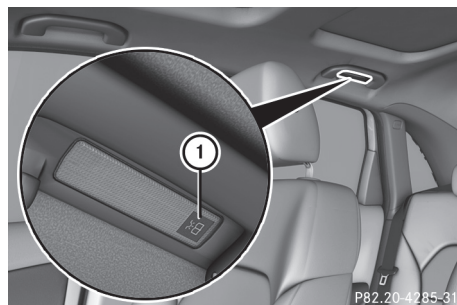

- ① To switch the reading lamp on/off

Interior lighting control

General notes

In order to prevent the vehicle's battery from discharging, the interior lighting functions are automatically deactivated after some time except when the SmartKey is in position **2** in the ignition lock.

The color and brightness of the ambient lighting are set via the multimedia system (see Digital Operator's Manual).

Automatic interior lighting control

- ▶ **To switch on:** set the switch to center position **6**.
- ▶ **To switch off:** set the switch to the  position.

The interior lighting automatically switches on if you:

- unlock the vehicle
- open a door
- remove the SmartKey from the ignition lock

The interior lighting is switched on for a set time when the SmartKey is removed from the ignition lock. You can set this delayed switch-off via the multimedia system (see Digital Operator's Manual).

Replacing bulbs

Important safety notes

WARNING

Bulbs, lamps and connectors can get very hot when operating. If you change a bulb, you could burn yourself on these components. There is a risk of injury.

Allow these components to cool down before changing a bulb.

Do not use a bulb if it has been dropped or if its glass tube has been scratched.

The bulb may explode if:

- you touch it
- it is hot
- you drop it
- you scratch it

Use bulbs only in closed lamps that have been designed for this purpose. Only install spare bulbs of the same type and the specified voltage.

Marks on the glass tube reduce the service life of the bulbs. Do not touch the glass tube with your bare hands. If necessary, clean the glass tube when cold with alcohol or spirit and rub it off with a lint-free cloth.

Protect bulbs from moisture during operation. Do not allow bulbs to come into contact with liquids.

Replace only the bulbs listed (▷ page 96). Have the bulbs that you cannot change yourself replaced at a qualified specialist workshop.

If you require assistance replacing bulbs, consult a qualified specialist workshop.

If the new bulb still does not light up, consult a qualified specialist workshop.

Headlamps and lights are an important aspect of vehicle safety. You must therefore make sure that these function correctly at all times. Have the headlamp setting checked regularly.

Vehicles with LED headlamps: the front and rear lamp clusters of your vehicle are equipped with LED bulbs. Do not replace the bulbs yourself. Contact a qualified specialist workshop which has the necessary specialist knowledge and tools to carry out the work required.

Overview of bulb types

You can replace the following bulbs. The bulb type can be found in the legend.

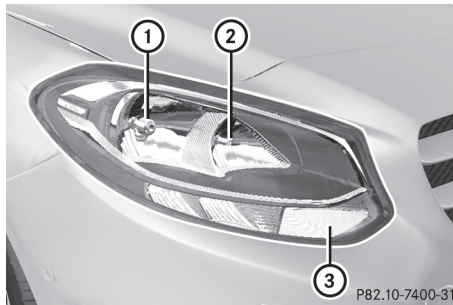

Vehicles with halogen headlamps

- ① Low-beam headlamp: H7 55 W
- ② High-beam headlamp: H7 55 W
- ③ Turn signal lamp: PY 21 W

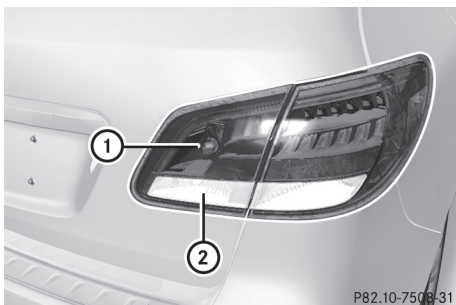

Tail lamps (vehicles with halogen headlamps)

- ① Rear fog lamp: P 21 W
- ② Backup lamp: W 16 W

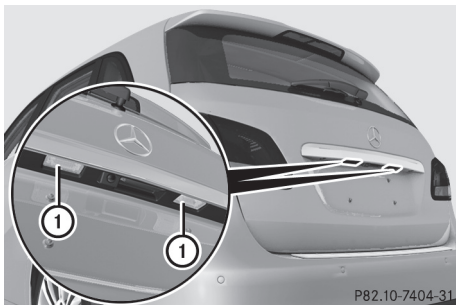

License plate lamp (vehicles with halogen headlamps)

- ① License plate lamp: C 5 W

Replacing front bulbs

Removing and installing the cover in the front wheel housing

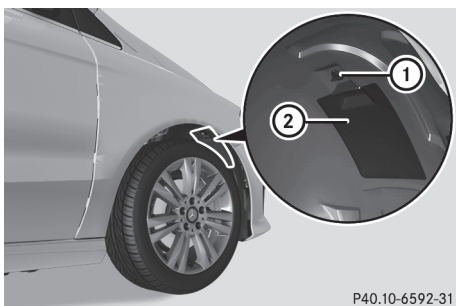

You must remove the cover of the front wheel housing before you can change the front turn signal lamp.

- ▶ **To remove:** switch off the lights.
- ▶ Turn the front wheels inwards.
- ▶ Turn rotary knob ① through 90°.
- ▶ Cover ② is released.
- ▶ Push cover ② down.
- ▶ **To install:** push cover ② up.
- ▶ Turn rotary knob ① through 90°.
- ▶ Cover ② is locked.

Low-beam headlamps (halogen headlamps)

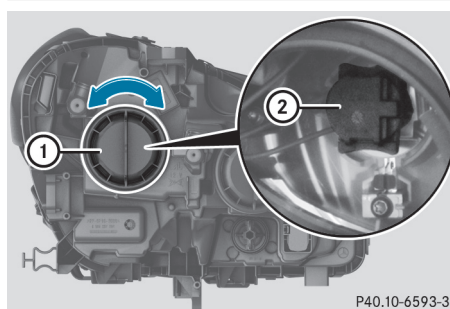

- ▶ Remove the cover in the front wheel housing (> page 97).
- ▶ Turn housing cover ① counter-clockwise and remove it.
- ▶ Turn bulb holder ② counter-clockwise and pull out.
- ▶ Pull the bulb out of bulb holder ②.
- ▶ Insert the new bulb into bulb holder ②.
- ▶ Insert bulb holder ② and turn it clockwise.
- ▶ Press on housing cover ① and turn it to the right.
- ▶ Replace the cover in the front wheel housing (> page 97).

High-beam headlamps (halogen headlamps)

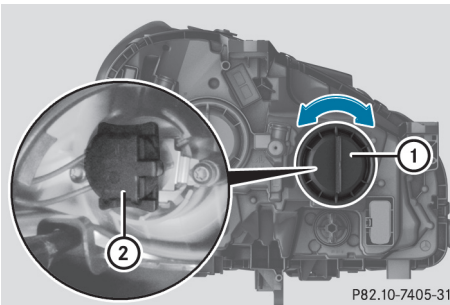

P82.10-7405-31

- ▶ Switch off the lights.
- ▶ Open the hood.
- ▶ Turn housing cover ① counter-clockwise and remove it.
- ▶ Turn bulb holder ② counter-clockwise and pull out.
- ▶ Insert the new bulb and engage it to the stop.
- ▶ Press on housing cover ① and turn it to the right.

Turn signals (halogen headlamps)

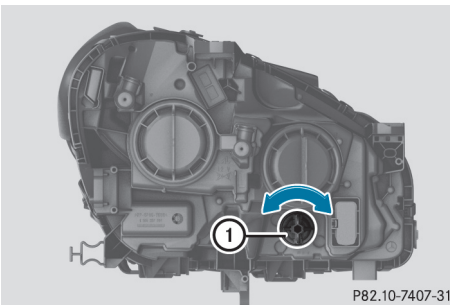

P82.10-7407-31

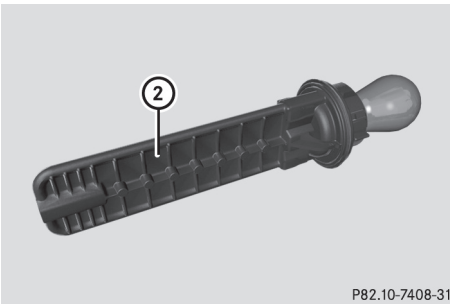

P82.10-7408-31

- ▶ Remove the cover in the front wheel housing (▷ page 97).
- ▶ Turn handle extension ② counter-clockwise and pull it out of holder ①.
- ▶ Press the bulb gently, turn it counter-clockwise and remove it.
- ▶ Insert the new bulb into bulb holder ①.
- ▶ Insert handle extension ② into holder ① and turn it clockwise until it engages.

Replacing rear bulbs

Tail lamps

Backup lamp and rear fog lamp

Due to their location, have the bulbs in the backup lamp and the fog lamp in the tailgate replaced at a qualified specialist workshop.

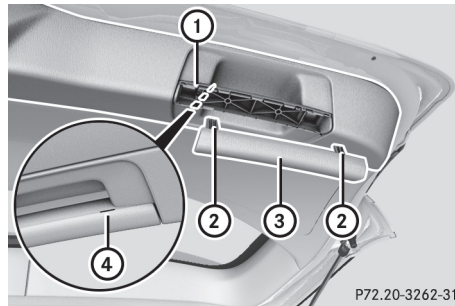

P72.20-3262-31

- ▶ Switch off the lights.
- ▶ Open the tailgate.
- ▶ In recess ④ on the inside of the closing handle, pry off and unclip ② the upper section of handle ③ with a flat smooth object, e.g. a screwdriver, and remove.
- ▶ Pull the lower section of handle ① using a sharp, sudden movement to remove it from the paneling and then place it to one side.

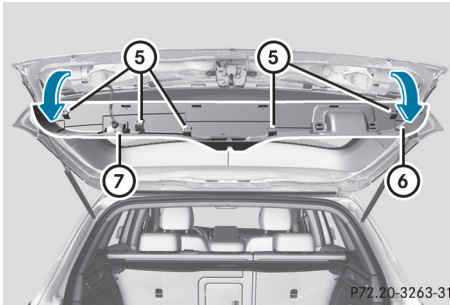

P72.20-3263-31

- ▶ Reach under the right-hand side of trim ⑥ and lightly tug along the entire length of the trim in order to unclip ⑤ it.
- ▶ Pull out connector ⑦ of the surround lighting by releasing the latches.
- ▶ Place paneling ⑥ to one side.

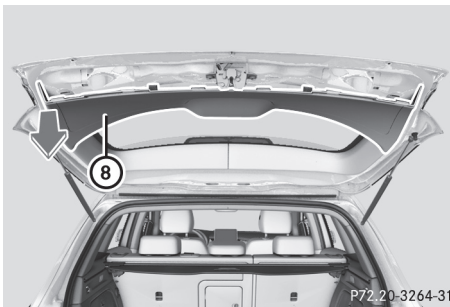

P72.20-3264-31

- ▶ On the side where the bulb is to be replaced, unclip the remaining part of trim ⑧ from the assembly with a strong tug, until the bulb holder is accessible.

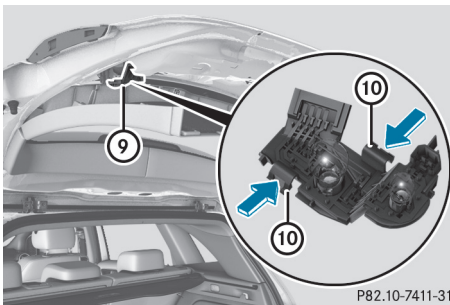

P82.10-7411-31

- ▶ Remove bulb holder ⑨ using both side levers ⑩.

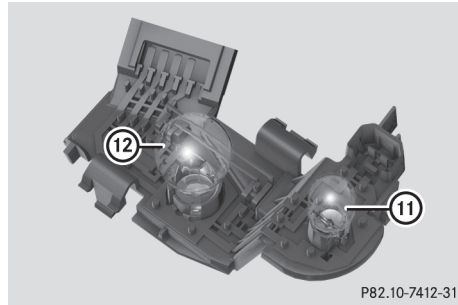

P82.10-7412-31

Bulb holder

- ▶ **Backup lamp ⑩**: pull the bulb out of bulb holder ⑨.
- ▶ Insert the new bulb into the bulb holder.
- ▶ **Rear fog lamp ⑫**: press the bulb gently into bulb holder ⑨, turn it counter-clockwise and remove it from the bulb holder.
- ▶ Insert the new bulb into the bulb holder and turn it clockwise.
- ▶ Reinsert the bulb holder until you hear it engage audibly.
- ▶ Position paneling ⑧ and engage it in place by tapping it with your hand.
- ▶ Before continuing with the installation, check that all the metal clips are inserted in the parts placed to one side: 2 clips ② in the upper part of handle ③ and 5 clips ⑤ in paneling ⑥.
- ▶ If not, remove the missing metal clips from the metal openings in the tailgate and insert them in the appropriate places.
- ▶ Take paneling ⑥ and connect plug connector ⑦ to the surround lighting.
- ▶ **i** The surround lighting only illuminates when the tailgate has been shut and reopened.
- ▶ Position paneling ⑥ and engage it in place by tapping it with your hand, starting from the outside.
- ▶ Clip in the lower section of handle ① at position ② again.
- ▶ Insert the upper section of handle ③ into lower section ① and engage with recess ④ again.

License plate lamp

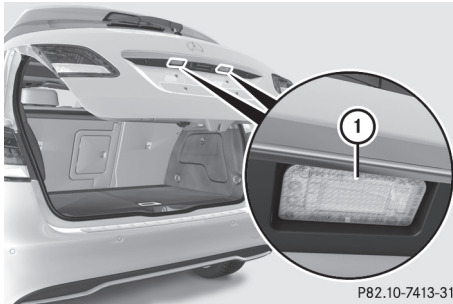

- ▶ Switch off the lights.
- ▶ Open the tailgate.
- ▶ Apply a screwdriver to lamp lens ① from the outside.
- ▶ Lever out lamp lens ① and remove it.
- ▶ Replace the bulb.
- ▶ Insert lamp lens ① into the license plate lamp and press it in until it engages.

Windshield wipers

Switching the windshield wipers on/off

! Do not operate the windshield wipers when the windshield is dry, as this could damage the wiper blades. Moreover, dust that has collected on the windshield can scratch the glass if wiping takes place when the windshield is dry.

If it is necessary to switch on the windshield wipers in dry weather conditions, always use washer fluid when operating the windshield wipers.

! If the windshield wipers leave smears on the windshield after the vehicle has been washed in an automatic car wash, wax or other residues may be the reason for this. Clean the windshield using washer fluid after washing the vehicle in an automatic car wash.

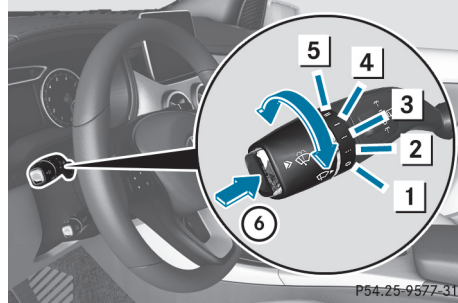

Combination switch

- ① 0 Windshield wiper off
- ② ... Intermittent wipe, low (rain sensor set to low sensitivity)
- ③ Intermittent wipe, high (rain sensor set to high sensitivity)
- ④ — Continuous wipe, slow
- ⑤ = Continuous wipe, fast
- ⑥ [Washer icon] Single wipe / [Washer icon] Wipes the windshield using washer fluid

- ▶ Switch on the ignition.
- ▶ Turn the combination switch to the corresponding position.

! Vehicles with a rain sensor: if the windshield becomes dirty in dry weather conditions, the windshield wipers may be activated inadvertently. This could then damage the windshield wiper blades or scratch the windshield.

For this reason, you should always switch off the windshield wipers in dry weather.

Vehicles with a rain sensor: in the ... or position, the appropriate wiping frequency is automatically set according to the intensity of the rain. In the position, the rain sensor is more sensitive than in the ... position, causing the windshield wiper to wipe more frequently.

If the wiper blades are worn, the windshield will no longer be wiped properly. This could prevent you from observing the traffic conditions.

Switching the rear window wiper on/off

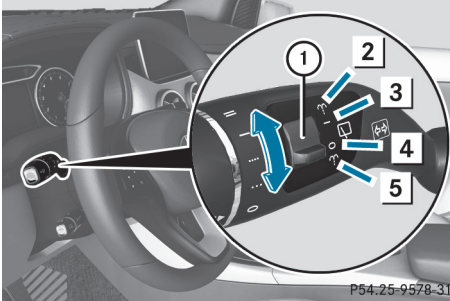

Combination switch

- ① Switch
- ② Wipes with washer fluid
- ③ Switches on intermittent wiping
- ④ Switches off intermittent wiping
- ⑤ Wipes with washer fluid

- ▶ Switch on the ignition.
- ▶ Slide switch ① on the combination switch to the corresponding position.

Vehicles with black and white multifunction display: when the rear window wiper is switched on, the symbol appears in the status overview in the instrument cluster. Further information on the status overview (> page 173).

Vehicles with color multifunction display: when the rear window wiper is switched on, the symbol appears in the assistance graphic in the instrument cluster. Further information on the assistance graphic (> page 173).

Replacing the wiper blades

Important safety notes

WARNING

If the windshield wipers begin to move while you are changing the wiper blades, you could be trapped by the wiper arm. There is a risk of injury.

Always switch off the windshield wipers and ignition before changing the wiper blades.

! To avoid damaging the wiper blades, make sure that you touch only the wiper arm of the wiper.

! Never open the hood/tailgate if a wiper arm has been folded away from the windshield/rear window.

Never fold a windshield wiper arm without a wiper blade back onto the windshield/rear window.

Hold the windshield wiper arm firmly when you change the wiper blade. If you release the wiper arm without a wiper blade and it falls onto the windshield/rear window, the windshield/rear window may be damaged by the force of the impact.

Mercedes-Benz recommends that you have the wiper blades changed at a qualified specialist workshop.

Changing the windshield wiper blades

Removing the wiper blades

- ▶ **Vehicles without KEYLESS-GO or KEYLESS-GO start function:** remove the SmartKey from the ignition lock.
- ▶ **Vehicles with KEYLESS-GO or KEYLESS-GO start function:** switch off the engine.
- ▶ Fold the wiper arm away from the windshield.

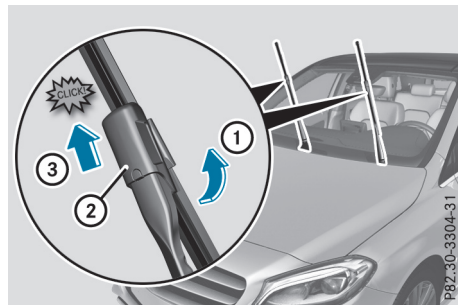

- ▶ Hold on to the wiper arm with one hand. With the other hand, turn wiper blade in direction of arrow ① away from the wiper arm as far as it will go.
- ▶ Slide catch ② in the direction of arrow ③ until it engages in the removal position with a noticeable click.

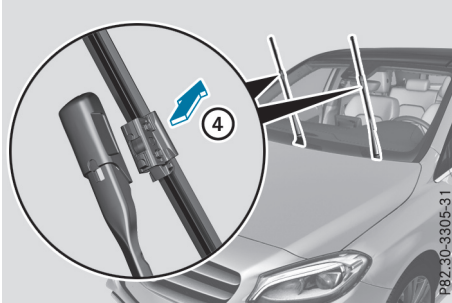

- ▶ Remove the wiper blade in the direction of arrow ④ away from the wiper arm.

Installing the wiper blades

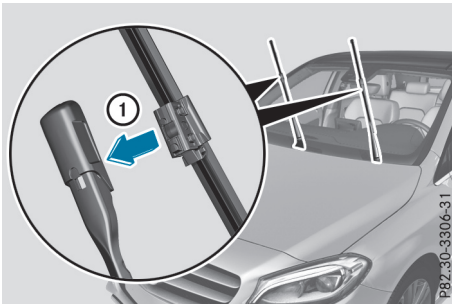

- ▶ Insert the new wiper blade into the wiper arm in the direction of arrow ①.

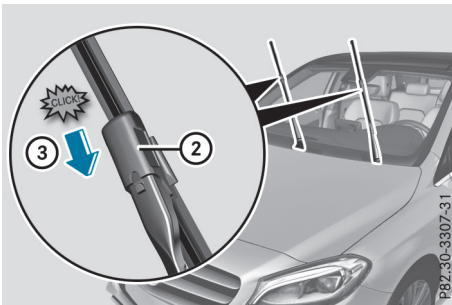

- ▶ Slide catch ② in the direction of arrow ③ until it engages in the locking position with a noticeable click.
- ▶ Make sure that the wiper blade is seated correctly.
- ▶ Fold the wiper arm back onto the windshield.

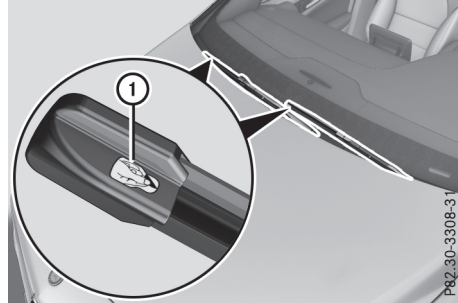

- ▶ Remove protective film ① of the service indicator on the tip of the wiper blade.

If the color of the service indicator changes from black to yellow, the wiper blades should be replaced.

- ⓘ The duration of the color change varies depending on the usage conditions.

Replacing the rear window wiper blade

Removing a wiper blade

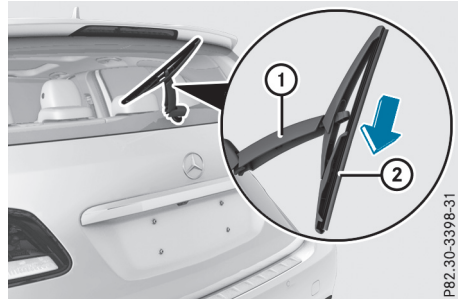

- ▶ **Vehicles without KEYLESS-GO or KEYLESS-GO start function:** remove the SmartKey from the ignition lock.
- ▶ **Vehicles with KEYLESS-GO or KEYLESS-GO start function:** switch off the engine.
- ▶ Fold wiper arm ① away from the rear window until you feel it engage.
- ▶ Position wiper blade ② at a right angle to wiper arm ①.
- ▶ Hold wiper arm ① and press wiper blade ② in the direction of the arrow until it releases.
- ▶ Remove wiper blade ②.

Installing a wiper blade

- ▶ Place new wiper blade ② onto wiper arm ①.
- ▶ Hold wiper arm ① and press wiper blade ② in the opposite direction to the arrow until it engages.
- ▶ Make sure that wiper blade ② is seated correctly.
- ▶ Position wiper blade ② parallel to wiper arm ①.
- ▶ Fold wiper arm ① back onto the rear window.

Problems with the windshield wipers

| Problem | Possible causes/consequences and ▶ Solutions |
|---|--|
| The windshield wipers are jammed. | Leaves or snow, for example, may be obstructing the windshield wiper movement. The wiper motor has been deactivated. <ul style="list-style-type: none"> ▶ For safety reasons, you should remove the SmartKey from the ignition lock. ▶ Remove the cause of the obstruction. ▶ Switch the windshield wipers back on. |
| The windshield wipers fail completely. | The windshield wiper drive is malfunctioning. <ul style="list-style-type: none"> ▶ Select another wiper speed on the combination switch. ▶ Have the windshield wipers checked at a qualified specialist workshop. |
| The windshield washer fluid from the spray nozzles no longer hits the center of the windshield. | The spray nozzles are misaligned. <ul style="list-style-type: none"> ▶ Have the spray nozzles adjusted at a qualified specialist workshop. |

Overview of climate control systems

General notes

Observe the settings recommended on the following pages. The windows could otherwise fog up.

To prevent the windows from fogging up:

- switch off climate control only briefly
- switch on air-recirculation mode only briefly
- switch on the cooling with air dehumidification function
- switch on the defrost windshield function briefly, if required

The air-conditioning system or dual-zone automatic climate control regulates the temperature and the humidity of the vehicle interior and filters undesirable substances from the air.

The air-conditioning system or dual-zone automatic climate control can only be operated when the engine is running. Optimum operation is only achieved with the side windows and panorama roof with power tilt/sliding panel closed. If you start the engine using your smartphone, the last selected climate control setting is reactivated (> page 76).

The residual heat function can only be activated or deactivated with the ignition switched off (> page 111).

Always keep the ventilation flaps behind the side paneling in the cargo compartment clear. Otherwise the vehicle will not be ventilated correctly.

- i** Ventilate the vehicle for a brief period during warm weather, e.g. using the convenience opening feature (> page 76). This will speed up the cooling process and the desired interior temperature will be reached more quickly.
- i** The integrated filter filters out most particles of dust and soot and completely filters out pollen. It also reduces gaseous pollutants and odors. A clogged filter reduces the amount of air supplied to the vehicle interior. For this reason, you should always observe the interval for replacing the filter, which is specified in the Maintenance Booklet. As it depends on environmental conditions, e.g. heavy air pollution, the interval may be shorter than stated in the Maintenance Booklet.
- i** It is possible that under certain circumstances the residual heat function may be activated automatically an hour after the SmartKey has been removed in order to dry the automatic climate control. The vehicle is then ventilated for 30 minutes.

Air-conditioning system control panel

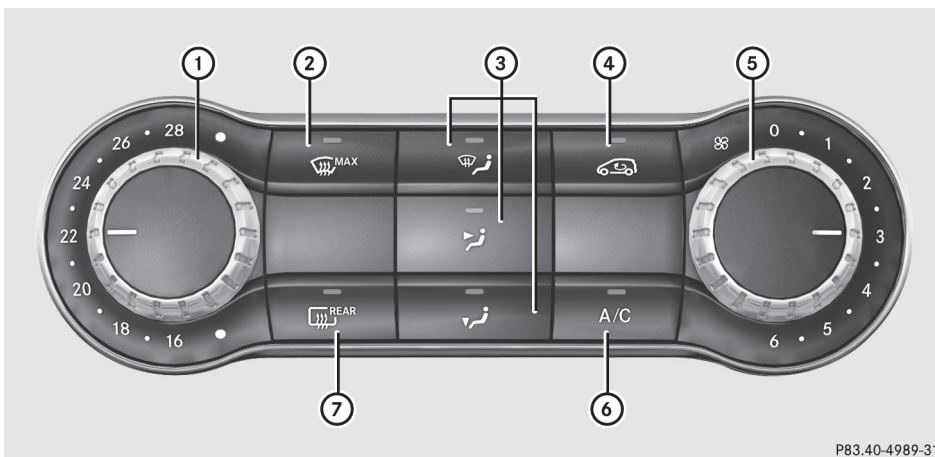

P83.40-4989-31

- ① Sets the temperature (> page 108)
- ② Defrosts the windshield (> page 109)

- ③ Sets the air distribution (▷ page 108)
- ④ Switches air-recirculation mode on/off (▷ page 111)
- ⑤ Sets the airflow (▷ page 109)
- ⑥ Switches cooling with air dehumidification on/off (▷ page 107)
- ⑦ Switches the rear window defroster on/off (▷ page 110)

Notes on using the air-conditioning system

Air-conditioning system

Below, you can find a number of notes and recommendations to help you use the air-conditioning system optimally.





- Switch on the air-conditioning system by turning control knob ⑤ clockwise to the desired position (except position 0).
- Set the temperature to 22 °C.

- **Recommendation for avoiding misted windows at low exterior temperatures or in rain:** switch on the  cooling with dehumidification function (▷ page 107).

Set air distribution to  and if possible switch off  and  (▷ page 108).

Deactivate air-recirculation mode  (▷ page 111).

Set airflow control ⑤ to a setting between 3 and 6 (▷ page 109).

- **Recommendation for rapid cooling or heating of the vehicle interior:** briefly set airflow control ⑤ to a setting between 3 and 6 (▷ page 109).
- **Recommendation for a constant vehicle interior temperature:** set airflow control ⑤ to a setting between 1 and 3 (▷ page 109).
- **Recommendation for air distribution in winter:** select the  and  settings (▷ page 108).
- **Recommendation for air distribution in summer:** select the  or  and  settings (▷ page 108).
- Only use the "Windshield defrosting" function briefly until the windshield is clear again.

- Only use air-recirculation mode briefly, e.g. if there are unpleasant outside odors or when in a tunnel. The windows could otherwise fog up, since no fresh air is drawn into the vehicle in air-recirculation mode.
- If you change the settings of the climate control system, the climate status display appears for approximately three seconds at the bottom of the screen on the multimedia system display; see Digital Operator's Manual. You will see the current settings of the various climate control functions.

DYNAMIC SELECT button

You can choose between various drive programs with the DYNAMIC SELECT button (▷ page 120).

If you have selected drive program **E**:

- when heating, the electrical heater booster is deactivated and in the warming-up phase heat output is reduced
- the rear window defroster running time is reduced

Depending on the configuration, climate settings may also be influenced in the drive program **I**.

If you have selected drive program **C** or **S**, climate settings are not influenced.

ECO start/stop function

During automatic engine switch-off, the climate control system only operates at a reduced capacity. If you require the full climate control output, you can switch off the ECO start/stop function by pressing the ECO button (▷ page 118).

Control panel for dual-zone automatic climate control

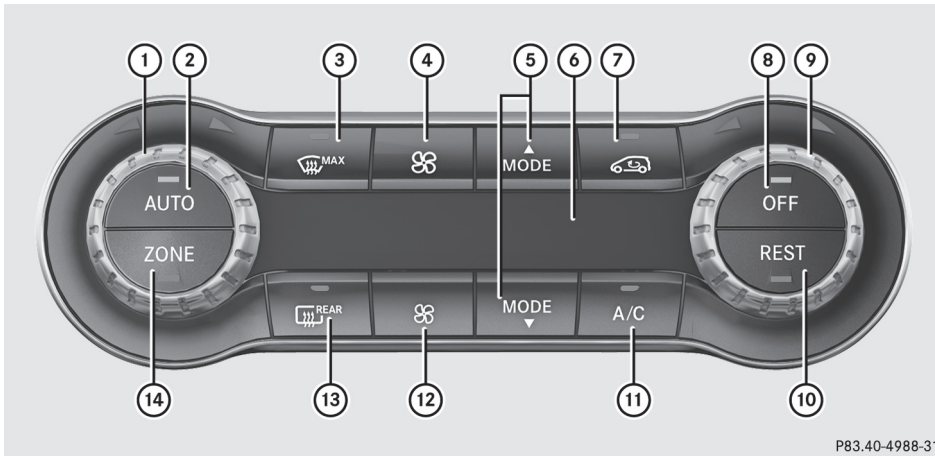

P83.40-4988-31

- ① Sets the temperature, left (▷ page 108)
- ② Sets climate control to automatic (▷ page 108)
- ③ Defrosts the windshield (▷ page 109)
- ④ Increases the airflow (▷ page 109)
- ⑤ Sets the air distribution (▷ page 108)
- ⑥ Display
- ⑦ Switches air-recirculation mode on/off (▷ page 111)
- ⑧ Activates/deactivates climate control (▷ page 107)
- ⑨ Sets the temperature, right (▷ page 108)
- ⑩ Switches the residual heat on or off (▷ page 111)
- ⑪ Switches cooling with air dehumidification on/off (▷ page 107)
- ⑫ Reduces the airflow (▷ page 109)
- ⑬ Switches the rear window defroster on/off (▷ page 110)
- ⑭ Switches the ZONE function on/off (▷ page 109)

Optimum use of dual-zone automatic climate control

Climate control system

The following contains instructions and recommendations to enable you to get the most out of your dual-zone automatic climate control.

- Activate climate control using the **AUTO** and **A/C** buttons. The indicator lamps in the **AUTO** and **A/C** buttons light up.
- Set the temperature to 22 °C.
- Only use the "Windshield defrosting" function briefly until the windshield is clear again.
- Only use air-recirculation mode briefly, e.g. if there are unpleasant outside odors or when in a tunnel. The windows could otherwise fog up, since no fresh air is drawn into the vehicle in air-recirculation mode.
- Use the ZONE function to adopt the temperature settings on the driver's side for the front-passenger side as well. The indicator lamp in the **ZONE** button goes out.
- Use the residual heat function if you want to heat or ventilate the vehicle interior when the ignition is switched off. The residual heat function can only be activated or deactivated with the ignition switched off.
- If you change the settings of the climate control system, the climate status display appears for approximately three seconds at the bottom of the screen on the multimedia

system display; see Digital Operator's Manual. You will see the current settings of the various climate control functions.

DYNAMIC SELECT button

You can choose between various drive programs with the DYNAMIC SELECT button (▷ page 120).

If you have selected drive program **E**:

- when heating, the electrical heater booster is deactivated and in the warming-up phase heat output is reduced
- the rear window defroster running time is reduced

Depending on the configuration, climate settings may also be influenced in the drive program **I**.

If you have selected drive program **C** or **S**, climate settings are not influenced.

ECO start/stop function

During automatic engine switch-off, the climate control system only operates at a reduced capacity. If you require the full climate control output, you can switch off the ECO start/stop function by pressing the ECO button (▷ page 118).

Operating the climate control systems

Activating/deactivating climate control

General notes

When the climate control is switched off, the air supply and air circulation are also switched off. The windows could fog up. Therefore, switch off climate control only briefly

Air-conditioning system

- ▶ Turn the SmartKey to position **2** in the ignition lock (▷ page 114).
- ▶ **To switch on:** turn control **5** clockwise to the desired position (except position **0**) (▷ page 104).
- ▶ **To switch off:** turn control **5** counter-clockwise to position **0** (▷ page 104).

Dual-zone automatic climate control

- ▶ Turn the SmartKey to position **2** in the ignition lock (▷ page 114).

- ▶ **To activate:** press the **AUTO** button. The indicator lamp in the **AUTO** button lights up. Airflow and air distribution are set to automatic mode.

or

- ▶ Press the **OFF** button. The indicator lamp in the **OFF** button goes out. The previously selected settings are restored.

- ▶ **To deactivate:** press the **OFF** button. The indicator lamp in the **OFF** button lights up.

- i** Dual-zone automatic climate control: switch on climate control primarily using the **AUTO** button.

Switching cooling with air dehumidification on/off

General notes

If you deactivate the "Cooling with air-dehumidification" function, the air inside the vehicle will not be cooled. The air inside the vehicle will also not be dehumidified. The windows can fog up more quickly. Therefore, only deactivate the "Cooling with air-dehumidification" function briefly.

The "Cooling with air dehumidification" function is only available when the engine is running. The air inside the vehicle is cooled and dehumidified according to the temperature selected.

Condensation may drip from the underside of the vehicle when it is in cooling mode. This is normal and not a sign that there is a malfunction.

Activating/deactivating

- ▶ Press the **A/C** button. The indicator lamp in the **A/C** button lights up or goes out. The indicator lamp in the button indicates that the respective function is activated. The "Cooling with air dehumidification" function has a delayed switch-off feature.

Problems with the "Cooling with air dehumidification" function

| Problem | Possible causes/consequences and ► Solutions |
|--|--|
| The indicator lamp in the  button flashes three times or remains off. The "Cooling with air dehumidification" function cannot be switched on. | Cooling with air dehumidification has been deactivated due to a malfunction. ► Visit a qualified specialist workshop. |

Setting climate control to automatic







General notes

The automatic climate control function is only available in conjunction with dual-zone automatic climate control.

In automatic mode, the set temperature is maintained automatically at a constant level. The system automatically regulates the temperature of the dispensed air, the airflow and the air distribution.

The "Cooling with air dehumidification" function is activated automatically in automatic mode.

Setting climate control to automatic

- Turn the SmartKey to position ② in the ignition lock (▷ page 114).
 - Set the desired temperature.
 - **To activate:** press the  button. The indicator lamp in the  button lights up. Automatic air distribution and airflow are activated.
 - **To switch to manual mode:** press the  or  button.
- or
- Press the  or  button. The indicator lamp in the  button goes out. Automatic air distribution and airflow are deactivated.

Setting the temperature

Air-conditioning system

You can set the temperature for the entire vehicle. The set temperature is automatically maintained at a constant level.

- Turn the SmartKey to position **2** in the ignition lock (▷ page 114).
- **To increase or reduce:** turn control ① counter-clockwise or clockwise (▷ page 104). Only change the temperature setting in small increments. Start at 22 °C.

Dual-zone automatic climate control



Different temperatures can be set for the driver's and front-passenger sides. The set temperature is automatically maintained at a constant level.

- Turn the SmartKey to position **2** in the ignition lock (▷ page 114).
- **To increase or decrease:** turn control ① or ② counter-clockwise or clockwise (▷ page 106). Only change the temperature setting in small increments. Start at 22 °C.

Setting the air distribution

Air-conditioning system



Air distribution settings

-  Directs air through the defroster vents
-  Directs air through the center and side air vents
-  Directs air through the footwell air vents

i You can also activate several air distribution settings simultaneously. To do this, press multiple air distribution buttons. The air is then directed through various vents.







i Regardless of the air distribution setting, airflow is always directed through the side air vents. The side air vents can only be closed if the adjusters are turned clockwise until they engage.

Setting the air distribution

- ▶ Turn the SmartKey to position **2** in the ignition lock (▷ page 114).
- ▶ Press one or more of the , ,  buttons.
The corresponding indicator lamp lights up briefly.



Dual-zone automatic climate control

Air distribution settings

-  Directs air through the defroster vents
-  Directs air through the center and side air vents
-  Directs air through the footwell air vents
-  Directs air through the center, side and footwell vents
-  Directs air through the defroster, center and side air vents
-  Directs air through the defroster and footwell vents
-  Directs air through the defroster, center, side and footwell vents

i Regardless of the air distribution setting, airflow is always directed through the side air vents. The side air vents can only be closed if the adjusters are turned clockwise until they engage.

Setting the air distribution



- ▶ Turn the SmartKey to position **2** in the ignition lock (▷ page 114).
- ▶ Press the  or  button repeatedly until the desired symbol appears in the display.

Setting the airflow

Air-conditioning system





- ▶ Turn the SmartKey to position **2** in the ignition lock (▷ page 114).
- ▶ **To increase or reduce:** turn control  counter-clockwise or clockwise (▷ page 104).

Dual-zone automatic climate control

- ▶ Turn the SmartKey to position **2** in the ignition lock (▷ page 114).
- ▶ **To increase or reduce:** press the  or  button.

Switching the ZONE function on/off

This function is only available with dual-zone automatic climate control.

- ▶ **To activate:** press the  button.
The indicator lamp in the  button lights up.
The temperature setting for the driver's side is not adopted for the front-passenger side.
- ▶ **To deactivate:** press the  button.
The indicator lamp in the  button goes out.
The temperature setting for the driver's side is adopted for the front-passenger side.



Defrosting the windshield

General notes

You can use this function to defrost the windshield or to clear a fogged up windshield and side windows.

i You should only select the "Windshield defrosting" function until the windshield is clear again.

Switching the "Windshield defrosting" function on or off



- ▶ Turn the SmartKey to position **2** in the ignition lock (▷ page 114).
- ▶ **To activate:** press the  button.
The indicator lamp in the  button lights up.



The climate control system switches to the following functions:

- high airflow
- high temperature
- air distribution to the windshield and front side windows
- air-recirculation mode off

i The "Windshield defrosting" function automatically sets the blower level to the optimum defrosting effect. As a result, the airflow may increase or decrease automatically after the  button is pressed.

i You can adjust the blower level manually while the "Windshield defrosting" function is in operation:



- Air-conditioning system: turn airflow control  counter-clockwise or clockwise (> page 104).
- Dual-zone automatic climate control: press the  or  button.

▶ **To deactivate:** press the  button. The indicator lamp in the  button goes out. The previously selected settings are restored. Air-recirculation mode remains deactivated.

or

▶ Dual-zone climate control: press the **AUTO** button. The indicator lamp in the  button goes out. Airflow and air distribution are set to automatic mode.

or

▶ Air-conditioning system: turn temperature control  counter-clockwise or clockwise (> page 104).
Dual-zone automatic climate control: turn temperature control  or  counter-clockwise or clockwise (> page 106).

Defrosting the windows

Windows fogged up on the inside

Air-conditioning system

- ▶ Activate the **A/C** "Cooling with air dehumidification" function.
- ▶ If the windows continue to fog up, activate the  "Windshield defrosting" function.



i You should only select this setting until the windshield is clear again.

Dual-zone automatic climate control

- ▶ Activate the **A/C** "Cooling with air dehumidification" function.
- ▶ Activate automatic mode **AUTO**.
- ▶ If the windows continue to fog up, activate the  "Windshield defrosting" function.

i You should only select this setting until the windshield is clear again.

Windows fogged up on the outside

- ▶ Activate the windshield wipers.
- ▶ Set the air distribution to  or .

i You should only select this setting until the windshield is clear again.



Rear window defroster

General notes

The rear window defroster has a high current draw. You should therefore switch it off as soon as the rear window is clear. Otherwise, the rear window defroster switches off automatically after several minutes.

If the battery voltage is too low, the rear window defroster may switch off.

Activating/deactivating

- ▶ Turn the SmartKey to position **2** in the ignition lock (> page 114).
- ▶ Press the  button. The indicator lamp in the  button lights up or goes out.

Problems with the rear window defroster

| Problem | Possible causes/consequences and ► Solutions |
|---|--|
| The rear window defroster has deactivated prematurely or cannot be activated. | <p>The battery has not been sufficiently charged.</p> <p>► Switch off any consumers that are not required, e.g. reading lamps, interior lighting or the seat heating.</p> <p>When the battery is sufficiently charged, the rear window defroster can be activated again.</p> |

Switching air-recirculation mode on/off

General notes



You can deactivate the flow of fresh air if unpleasant odors are entering the vehicle from outside. The air already inside the vehicle will then be recirculated.

If you switch on air-recirculation mode, the windows can fog up more quickly, in particular at low temperatures. Only use air-recirculation mode briefly to prevent the windows from fogging up.

The operation of air-recirculation mode is the same for all control panels.

Activating/deactivating



► Turn the SmartKey to position **2** in the ignition lock (► page 114).

► **To activate:** press the  button. The indicator lamp in the  button lights up.

Air-recirculation mode switches on automatically:

- at high outside temperatures
- at high levels of pollution

When air-recirculation mode is activated automatically, the indicator lamp in the  button is not lit. Outside air is added after about 30 minutes.

► **To deactivate:** press the  button. The indicator lamp in the  button goes out.

i Air-recirculation mode deactivates automatically:

- after approximately five minutes at outside temperatures below approximately 7 °C
- after approximately five minutes if the "Cooling with air dehumidification" function is deactivated
- after approximately 30 minutes at outside temperatures above approximately 7 °C if the "Cooling with dehumidification" function is activated

Switching the residual heat on or off

General notes

The residual heat function is only available with dual-zone automatic climate control.

It is possible to make use of the residual heat of the engine to continue heating the vehicle for approximately 30 minutes after the engine has been switched off. The heating time depends on the set interior temperature.

i The blower will run at a low speed regardless of the airflow setting.

i If you activate the residual heat function at high temperatures, only the ventilation will be activated. The blower runs at medium speed.

i You cannot use the ventilation to cool the vehicle interior to a temperature lower than the outside temperature.

Activating/deactivating

► Turn the SmartKey to position **0** in the ignition lock or remove it (► page 114).

► Press the **REST** button. The indicator lamp in the **REST** button lights up or goes out.

The indicator lamp in the button indicates that the respective function is activated.

- i** Residual heat is deactivated automatically:
 - after approximately 30 minutes
 - when the ignition is switched on
 - if the battery voltage drops

Air vents

Important safety notes

WARNING

Very hot or very cold air can flow from the air vents. This could result in burns or frostbite in the immediate vicinity of the air vents. There is a risk of injury.

Make sure that all vehicle occupants always maintain a sufficient distance to the air outlets. If necessary, redirect the airflow to another area of the vehicle interior.

In order to ensure the direct flow of fresh air through the air vents into the vehicle interior, please observe the following notes:

- keep the air inlet between the windshield and the hood free of blockages, such as ice, snow or leaves.
 - never cover the air vents or air intake grilles in the vehicle interior.
- i** For optimal climate control in the vehicle, open the air vents completely and set the adjusters to the central position.

Setting the air vents

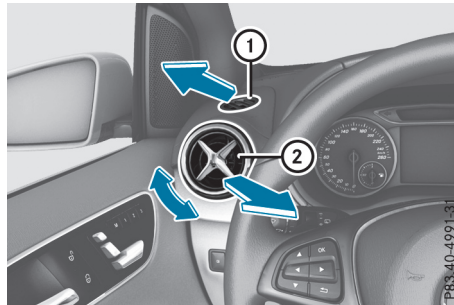

- ① Side window defroster vent
- ② Side air vent

- ▶ **To open a side air vent:** turn the adjuster in side air vent ② to the left.
- ▶ **To close a side air vent:** turn the adjuster in side air vent ② clockwise as far as it will go.

- i** The center and rear air vents are adjusted in the same way.

Notes on breaking-in a new vehicle

Important safety notes

The sensor system of some driving and driving safety systems adjusts automatically while a certain distance is being driven after the vehicle has been delivered or after repairs. Full system effectiveness is not reached until the end of this teach-in procedure.

New and replaced brake pads and discs only reach their optimum braking effect after several hundred kilometers of driving. Compensate for this by applying greater force to the brake pedal.

The first 1000 miles (1500 km)

The more you look after the engine when it is new, the more satisfied you will be with its performance in the future.

- You should therefore drive at varying vehicle and engine speeds for the first 1000 miles (1500 km).
- Avoid heavy loads, e.g. driving at full throttle, during this period.
- Change gear in good time, before the tachometer needle is $\frac{2}{3}$ of the way to the red area of the tachometer.
- Do not manually shift to a lower gear to brake the vehicle.
- Try to avoid depressing the accelerator pedal beyond the point of resistance (kickdown).
- Ideally, for the first 1000 miles (1500 km), drive in program **E**.

After 1,000 miles (1,500 km), you can increase the engine speed gradually and bring the vehicle to full speed.

You should also observe these notes on breaking-in if the engine or parts of the drive train on your vehicle have been replaced.

Always observe the maximum permissible speed.

Driving

Important safety notes

WARNING

Objects in the driver's footwell can restrict the pedal travel or obstruct a depressed pedal.

The operating and road safety of the vehicle is jeopardized. There is a risk of an accident.

Make sure that all objects in the vehicle are stowed correctly, and that they cannot enter the driver's footwell. Install the floor mats securely and as specified in order to ensure sufficient clearance for the pedals. Do not use loose floor mats and do not place floor mats on top of one another.

WARNING

Unsuitable footwear can hinder correct usage of the pedals, e.g.:

- shoes with thick soles
- shoes with high heels
- slippers

There is a risk of an accident.

Wear suitable footwear to ensure correct usage of the pedals.

WARNING

If you switch off the ignition while driving, safety-relevant functions are only available with limitations, or not at all. This could affect, for example, the power steering and the brake boosting effect. You will require considerably more effort to steer and brake. There is a risk of an accident.

Do not switch off the ignition while driving.

WARNING

If the parking brake has not been fully released when driving, the parking brake can:

- overheat and cause a fire
- lose its hold function.

There is a risk of fire and an accident. Release the parking brake fully before driving off.

! Do not warm up the engine while stationary. Pull away immediately. Avoid high engine speeds and full throttle until the engine has reached its operating temperature.

In vehicles with automatic transmission, engage positions P and R only when the vehicle is stationary.

Where possible, avoid spinning the drive wheels when pulling away on slippery roads. You could otherwise damage the drive train.

Key positions

SmartKey

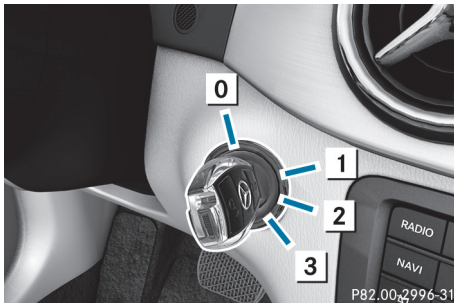

- 0 To remove the SmartKey (shift the transmission to position **P**)
 - 1 Power supply for some consumers, such as the windshield wipers
 - 2 Ignition (power supply for all consumers) and drive position
 - 3 To start the engine
- i** The SmartKey can be turned in the ignition lock even if it is not the correct SmartKey for the vehicle. The ignition is not switched on. The engine cannot be started.

Start/Stop button

General notes

Vehicles with KEYLESS-GO are equipped with SmartKeys featuring the integrated KEYLESS-GO function and a detachable Start/Stop button.

A check which periodically establishes a radio connection between the vehicle and the SmartKey determines whether a valid SmartKey is in the vehicle. This occurs, for example, when starting the engine.

When you insert the Start/Stop button into the ignition lock, the system needs approximately two seconds recognition time. You can then use the Start/Stop button.

Pressing the Start/Stop button several times in succession corresponds to the different Smart-

Key positions in the ignition lock. This is only the case if you are not depressing the brake pedal. If you depress the brake pedal and press the Start/Stop button, the engine starts immediately.

To start the vehicle without actively using the SmartKey:

- the Start/Stop button must be inserted in the ignition lock
- the SmartKey must be in the vehicle
- the vehicle must not be locked with the SmartKey or KEYLESS-GO (▷ page 64)

Do not keep the KEYLESS-GO key:

- with electronic devices, e.g. a mobile phone or another SmartKey.
- with metallic objects, e.g. coins or metal foil.
- inside metallic objects, e.g. a metal case.

This can affect the functionality of KEYLESS-GO. If you lock the vehicle with the SmartKey remote control or with KEYLESS-GO, after a short time:

- you will not be able to switch on the ignition with the Start/Stop button.
- you will no longer be able to start the engine with the Start/Stop button until the vehicle is unlocked again.

If you lock the vehicle centrally using the button on the front door (▷ page 70), you can continue to start the engine with the Start/Stop button.

The engine can be switched off while the vehicle is in motion by pressing and holding the Start/Stop button for three seconds. This function operates independently of the ECO start/stop automatic engine switch-off function.

Key positions with the Start/Stop button

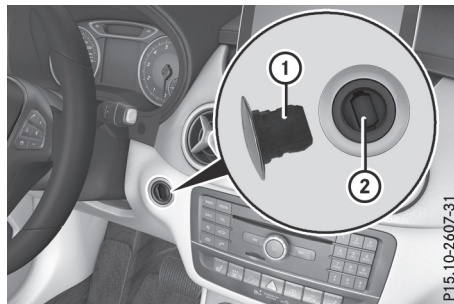

- ① Start/Stop button
- ② Ignition lock

As soon as the ignition is switched on, all the indicator lamps in the instrument cluster light up.

For further information on situations in which an indicator lamp either fails to go out after the engine is started or lights up while driving, please refer to "Warning and indicator lamps in the instrument cluster" (> page 205).

If Start/Stop button ① has not yet been pressed, this is the same as the SmartKey being removed from the ignition.

► **To switch on the power supply:** press Start/Stop button ① once.

The power supply is switched on. You can now activate the windshield wipers, for example.

The power supply is switched off again if:

- the driver's door is opened and
- you press Start/Stop button ① twice when in this position

► **To switch on the ignition:** press Start/Stop button ① twice.

The ignition is switched on.

If you press Start/Stop button ① once when in this position, the ignition is switched off again.

Removing the Start/Stop button

You can remove the Start/Stop button from the ignition lock and start the vehicle as normal using the SmartKey.

You can only switch between Start/Stop button mode and SmartKey operation when the vehicle is stationary.

You must also engage park position **P**.

► Remove Start/Stop button ① from ignition lock ②.

You do not have to remove the Start/Stop button from the ignition lock when you leave the vehicle. You should, however, always take the SmartKey with you when leaving the vehicle. As long as the SmartKey is in the vehicle:

- the vehicle can be started using the Start/Stop button
- the electrically powered equipment can be operated

Starting the engine

Important safety notes

WARNING

If children are left unsupervised in the vehicle, they could:

- operate the vehicle's equipment.
- Additionally, children could set the vehicle in motion if, for example, they:
- release the parking brake
 - shift the automatic transmission out of park position **P**
 - start the engine

There is a risk of an accident and injury.

Never leave children or animals unattended in the vehicle.

When leaving the vehicle, always take the SmartKey with you and lock the vehicle. This also applies to mobile phones if the "Digital Car Key in smartphone" function is activated via the Mercedes me connect web app.

WARNING

Combustion engines emit poisonous exhaust gases such as carbon monoxide. Inhaling these exhaust gases leads to poisoning. There is a risk of fatal injury. Therefore never leave the engine running in enclosed spaces without sufficient ventilation.

WARNING

Flammable materials introduced through environmental influence or by animals can ignite if in contact with the exhaust system or parts of the engine that heat up. There is a risk of fire.

Carry out regular checks to make sure that there are no flammable foreign materials in the engine compartment or in the exhaust system.

General notes

During a cold start, the engine runs at higher speeds to enable the catalytic converter to reach its operating temperature. The sound of the engine may change during this time.

Automatic transmission

- ▶ Shift the transmission to position **P** (> page 121).
The transmission position indicator on the multifunction display shows **P** (> page 121).

i You can start the engine in transmission positions **P** and **N**.

Starting procedure with the SmartKey

To start the engine using the SmartKey instead of the Start/Stop button, pull the Start/Stop button out of the ignition lock.

- ▶ Turn the SmartKey to position **3** in the ignition lock (> page 114) and release it as soon as the engine is running.

Starting procedure with the Start/Stop button

The Start/Stop button can be used to start the vehicle manually without inserting the SmartKey into the ignition lock. The Start/Stop button must be inserted in the ignition lock and the SmartKey must be in the vehicle. This mode for starting the engine operates independently of the ECO start/stop automatic engine start function.

You can start the engine if a valid SmartKey is in the vehicle. Switch off the engine and always take the SmartKey with you when leaving the vehicle, even if you only leave it for a short time. Pay attention to the important safety notes.

- ▶ Depress the brake pedal and keep it depressed.
- ▶ Press the Start/Stop button once (> page 114).
The engine starts.

Starting procedure via smartphone

Observe the important safety notes on starting the engine (> page 115).

You can also start your engine via your smartphone from outside the vehicle. In this case, the previously selected climate control setting is activated. In this way you can cool or heat the interior of the vehicle before starting the journey.

Only start the engine via your smartphone if it is safe to start and run the engine where your vehicle is parked.

Observe the legal stipulations in the area where your vehicle is parked. Engine start via smartphone may be limited to certain countries or regions.

You can execute a maximum of two consecutive starting attempts via your smartphone. If you insert the SmartKey into the ignition lock, you can carry out two more starting attempts.

Once you have started the engine, you can switch the engine off via your smartphone at any time.

You can only start the engine via your smartphone if:

- the SmartKey is in the ignition lock
- park position **P** is selected
- the accelerator pedal is not depressed
- the alarm for the anti-theft alarm system is not set
- the panic alarm is not activated
- the hazard warning lamps are switched off
- the hood is closed
- the doors are closed and locked
- the windows and sliding sunroof are closed

Also make sure that:

- the fuel tank is sufficiently filled
- the starter battery is sufficiently charged

WARNING

Limbs could be crushed or trapped if the engine is started unintentionally during service or maintenance work. There is a risk of injury.

Always secure the engine against unintentional starting before carrying out maintenance or repair work.

Make sure that the engine cannot be started via your smartphone before carrying out maintenance or repairs. You can prevent an engine start via your smartphone, for example, if you:

- switch on the hazard warning lamps
- do not lock the doors
- open the hood

Pulling away

General notes

WARNING

If the engine speed is above the idling speed and you engage transmission position **D** or **R**, the vehicle could pull away suddenly. There is a risk of an accident.

When engaging transmission position **D** or **R**, always firmly depress the brake pedal and do not simultaneously accelerate.

Depress the accelerator carefully when pulling away.

The vehicle locks centrally once you have pulled away. The locking knobs in the doors drop down. You can open the doors from the inside at any time.

You can also deactivate the automatic locking feature (> page 176).

It is possible to shift the transmission from position **P** to the desired position only if you depress the brake pedal. Only then can the parking lock be deactivated.

If you do not depress the brake pedal, the DIRECT SELECT lever can still be moved but the parking lock remains engaged.

At transmission fluid temperatures below -4°F (-20°C), you can only shift out of position **P** into another transmission position when the engine is running.

-  **i** Upshifts take place at higher engine speeds after a cold start. This helps the catalytic converter to reach its operating temperature more quickly.

Information on the automatic release of the electric parking brake (> page 131).

Hill start assist

Hill start assist helps you when pulling away forward or in reverse on an uphill gradient. It holds the vehicle for a short time after you have removed your foot from the brake pedal. This gives you enough time to move your foot from the brake pedal to the accelerator pedal and to depress it before the vehicle begins to roll.

WARNING

After a short time, hill start assist will no longer brake your vehicle and it could roll away. There is a risk of an accident and injury.

Therefore, quickly move your foot from the brake pedal to the accelerator pedal. Never leave the vehicle when it is held by hill start assist.

Hill start assist is not active if:

- you are pulling away on a level road or on a downhill gradient.
- the transmission is in position **N**.
- the electric parking brake is applied.
- ESP[®] is malfunctioning.

Further information on holding the vehicle stationary on uphill gradients (> page 124).

ECO start/stop function

Introduction

The ECO start/stop function switches the engine off automatically if the vehicle is stopped under certain conditions.

The engine starts automatically when the driver wants to pull away again. The ECO start/stop function thereby helps you to reduce the fuel consumption and emissions of your vehicle.

Important safety notes

WARNING

If the engine is switched off automatically and you exit the vehicle, the engine is restarted automatically. The vehicle may begin moving. There is a risk of accident and injury.

If you wish to exit the vehicle, always turn off the ignition and secure the vehicle against rolling away.

General notes

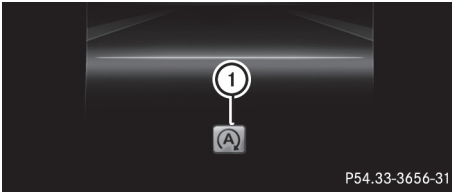

- ① ECO start/stop display (example: color multifunction display)

The ECO start/stop function is activated whenever you start the engine using the SmartKey or the Start/Stop button.

If the engine has been switched off automatically by the ECO start/stop function, the  ECO symbol is shown in the multifunction display.

Automatic engine switch-off

If the vehicle is braked to a standstill in **D** or **N**, the ECO start/stop function switches off the engine automatically.

The ECO start/stop function is operational when:

- the indicator lamp in the ECO button is lit green.
- the outside temperature is within the range that is suitable for the system.
- the engine is at normal operating temperature.
- the set temperature for the vehicle interior has been reached.
- the battery is sufficiently charged.
- the system detects that the windshield is not fogged up when the air-conditioning system is switched on.
- the hood is closed.
- the driver's door is closed and the driver's seat belt is fastened.

All of the vehicle's systems remain active when the engine is stopped automatically.

The HOLD function can also be activated if the engine has been switched off automatically. It is then not necessary to continue applying the brakes during the automatic stop phase. When you depress the accelerator pedal, the engine starts automatically and the braking effect of the HOLD function is deactivated.

Automatic engine switch-off can take place a maximum of four times in a row (initial stop, then three subsequent stops).

Automatic engine start

The engine starts automatically if:

- you switch off the ECO start/stop function by pressing the ECO button
- in transmission position **D** or **N** the brake pedal is released and the HOLD function is not active
- you depress the accelerator pedal
- you engage reverse gear **R**
- you move the transmission out of position **P**
- you unfasten your seat belt or open the driver's door
- the vehicle starts to roll
- the brake system requires this
- the temperature in the vehicle interior deviates from the set range
- the system detects moisture on the windshield when the air-conditioning system is switched on
- the battery's condition of charge is too low

Shifting the transmission to position **P** does not start the engine.

Deactivating or activating the ECO start/stop function

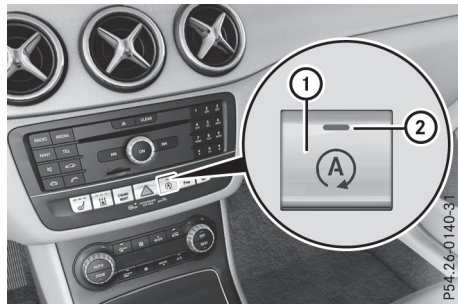

- ▶ **To deactivate:** press ECO button ①. Indicator lamp ② goes out.
- ▶ **To activate:** press ECO button ①. Indicator lamp ② lights up.

If indicator lamp ② is off, the ECO start/stop function has been deactivated manually or as the result of a malfunction. The engine will then

not be switched off automatically when the vehicle stops.

| Problems with the engine | |
|---|---|
| Problem | Possible causes/consequences and ► Solutions |
| The engine does not start. | <p>The HOLD function or Distance Pilot DISTRONIC is activated.</p> <ul style="list-style-type: none"> ► Deactivate the HOLD function (▷ page 147) or Distance Pilot DISTRONIC (▷ page 144). ► Try to start the engine again. |
| The engine does not start. The starter motor can be heard. | <ul style="list-style-type: none"> • There is a malfunction in the engine electronics. • There is a malfunction in the fuel supply. <p>Before attempting to start the engine again:</p> <ul style="list-style-type: none"> ► Turn the SmartKey back to position 0 in the ignition lock. <p>or</p> <ul style="list-style-type: none"> ► Press the Start/Stop button repeatedly until all indicator lamps in the instrument cluster go out. ► Try to start the engine again. Avoid excessively long and frequent attempts to start the engine as these will drain the battery. <p>If the engine does not start after several attempts:</p> <ul style="list-style-type: none"> ► Consult a qualified specialist workshop. |
| The engine does not start. You cannot hear the starter motor. | <p>The on-board voltage is too low because the battery is too weak or discharged.</p> <ul style="list-style-type: none"> ► Jump-start the vehicle (▷ page 260). <p>If the engine does not start despite attempts to jump-start it:</p> <ul style="list-style-type: none"> ► Consult a qualified specialist workshop. <p>The starter motor was exposed to a thermal load that was too high.</p> <ul style="list-style-type: none"> ► Allow the starter motor to cool down for approximately two minutes. ► Try to start the engine again. <p>If the engine still does not start:</p> <ul style="list-style-type: none"> ► Consult a qualified specialist workshop. |

| Problem | Possible causes/consequences and ► Solutions |
|--|--|
| The engine is not running smoothly and is misfiring. | <p>There is a malfunction in the engine electronics or in a mechanical component of the engine management system.</p> <ul style="list-style-type: none"> ► Only depress the accelerator pedal slightly. Otherwise, non-combusted fuel may get into the catalytic converter and damage it. ► Have the cause rectified immediately at a qualified specialist workshop. |
| The coolant temperature gauge shows a value above 248 °F (120 °C). The coolant warning lamp may also be on and a warning tone may sound. | <p>The coolant level is too low. The coolant is too hot and the engine is no longer being cooled sufficiently.</p> <ul style="list-style-type: none"> ► Stop as soon as possible and allow the engine and the coolant to cool down. ► Check the coolant level (► page 242). Observe the warning notes as you do so and add coolant if necessary. |

DYNAMIC SELECT button

Use the DYNAMIC SELECT button to change the drive program. Depending on the drive program selected the following vehicle characteristics will change:

- the drive (engine and transmission management)
- the suspension (vehicles with damping system)
- the sound of the exhaust system (vehicles with sports exhaust system)
- the steering
- the availability of the ECO start/stop function
- the climate control

Each time you start the engine with the Smart-Key or the Start/Stop button, drive program **C** is activated. For further information about starting the engine, see (► page 124).



- Press DYNAMIC SELECT button ① as many times as necessary until the desired drive program is selected.

The selected drive program appears in the multifunction display. After five seconds the display goes out and the status icon of the selected drive program appears.

In addition, the current drive program settings are displayed briefly in the multimedia system display.

- i** In a few countries, the ECO start/stop function is deactivated at the factory due to the available fuel grade. In this case, the ECO start/stop function is not available in any drive program, regardless of the display in the multimedia system display.

Available drive programs:

| | |
|---------------------|--|
| C Comfort | Comfortable and economical driving characteristics |
| S Sport | Sporty driving characteristics |
| I Individual | Individual settings |
| E Economy | Particularly economical driving characteristics |

Additional information for drive programs (► page 124).

You can also change gear yourself using the steering wheel paddle shifters. For further information on the manual drive program (► page 125).

Automatic transmission

Important safety notes

WARNING

If the engine speed is above the idling speed and you engage transmission position **D** or **R**, the vehicle could pull away suddenly. There is a risk of an accident.

When engaging transmission position **D** or **R**, always firmly depress the brake pedal and do not simultaneously accelerate.

WARNING

The automatic transmission switches to neutral position **N** when you switch off the engine. The vehicle may roll away. There is a risk of an accident.

After switching off the engine, always switch to parking position **P**. Prevent the parked vehicle from rolling away by applying the parking brake.

DIRECT SELECT lever

Overview of transmission positions

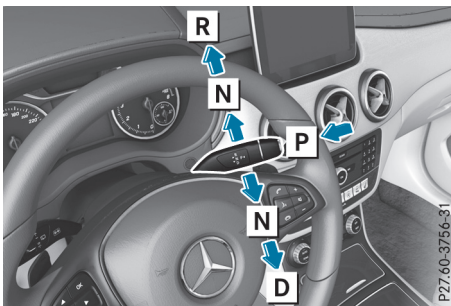

- P** Park position with parking lock
- R** Reverse gear
- N** Neutral
- D** Drive

The DIRECT SELECT lever is on the right of the steering column.

The DIRECT SELECT lever always returns to its original position. The current transmission position **P**, **R**, **N** or **D** is shown in the transmis-

sion position display in the multifunction display (> page 121).

Transmission position and drive program display

The current transmission position and drive program appear in the multifunction display.

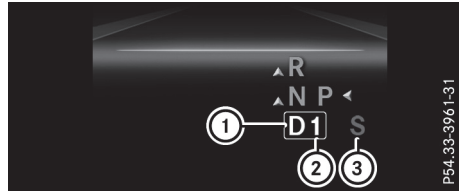

- ① Transmission position display
- ② Gear
- ③ Drive program display

The arrows in the transmission position display show how and into which transmission positions you can shift using the DIRECT SELECT lever.

If the transmission position display in the multifunction display is not working, you should pull away carefully to check whether the desired transmission position is engaged. Ideally, you should select transmission position **D** and drive program **E** or **S**.

Engaging park position P

! If the engine speed is too high or the vehicle is coasting, do not shift the automatic transmission directly from **D** to **R**, from **R** to **D** or directly to **P**. Otherwise, the automatic transmission may be damaged.

- ▶ Push the DIRECT SELECT lever switch in the direction of arrow **P**. Transmission position display **P** is shown in the multifunction display.

When you have engaged park position **P**, make sure that the transmission position display shows **P** in the multifunction display.

You can engage park position **P** only when the vehicle is stationary; do not switch directly to park position **P** at high engine speed.

Depressing the brake and pushing the DIRECT SELECT lever up or down disengages the parking lock. The transmission is in neutral **N**.

At transmission fluid temperatures below -4 °F (-20 °C), you can only shift out of park position

P into another transmission position when the engine is running.

In order to shift from park position **P** directly into **R** or **D**:

- depress the brake pedal and
- push the DIRECT SELECT lever up or down past the first point of resistance

Engaging park position P automatically

Park position **P** is automatically engaged if:

- you switch off the engine using the SmartKey and remove the SmartKey
- you switch off the engine using the SmartKey or using the Start/Stop button and open the driver's door or front-passenger door
- you open the driver's door when the vehicle is stationary or when driving at a very low speed and the transmission is in position **D** or **R**

In certain situations, the automatic transmission shifts automatically to transmission position **P** if the HOLD function or Distance Pilot DISTRONIC is activated. Observe the information on the HOLD function (> page 147) and on Distance Pilot DISTRONIC (> page 143).

Engaging reverse gear R

! Only move the automatic transmission to **R** when the vehicle is stationary.

- ▶ Depress the brake and keep it pressed.
- ▶ Push the DIRECT SELECT lever up past the first point of resistance.

The ECO start/stop function is not available when reverse gear is engaged. Further information on the ECO start/stop function (> page 118).

Shifting to neutral N

WARNING

If children are left unsupervised in the vehicle, they could:

- operate the vehicle's equipment.

Additionally, children could set the vehicle in motion if, for example, they:

- release the parking brake
- shift the automatic transmission out of park position **P**
- start the engine

There is a risk of an accident and injury.

Never leave children or animals unattended in the vehicle.

When leaving the vehicle, always take the SmartKey with you and lock the vehicle. This also applies to mobile phones if the "Digital Car Key in smartphone" function is activated via the Mercedes me connect web app.

- ▶ If the transmission is in position **D** or **R**: push the DIRECT SELECT lever up or down to the first point of resistance.
- ▶ If the transmission is in position **P**: depress the brake pedal and push the DIRECT SELECT lever up or down to the first point of resistance.

If you switch the engine off with the transmission in position **R** or **D**, the automatic transmission shifts to **N** automatically.

With the SmartKey: if you then open the driver's door or the front-passenger door or remove the SmartKey from the ignition, the automatic transmission shifts to **P** automatically.

With the Start/Stop button: if you then open the driver's door or the front-passenger door, the automatic transmission shifts to **P** automatically.

If you want the automatic transmission to remain in neutral **N**, e.g. when having the vehicle cleaned in an automatic car wash with a towing system:

- ▶ **Vehicles with the Start-Stop button:** remove the Start-Stop button from the ignition lock.
- ▶ Insert the SmartKey into the ignition lock.
- ▶ **All vehicles:** switch the ignition on.
- ▶ Depress the brake pedal and keep it depressed.
- ▶ Engage neutral **N**.
- ▶ Release the brake pedal.

- ▶ Release the electric parking brake.
- ▶ Switch off the ignition and leave the SmartKey in the ignition lock.

Engaging drive position D

- ▶ If the transmission is in position **R** or **N**: push the DIRECT SELECT lever down past the first point of resistance.
- ▶ If the transmission is in position **P**: depress the brake pedal and push the DIRECT SELECT lever down past the first point of resistance.

Transmission positions

P Park position

This prevents the vehicle from rolling away when stopped.

Only shift the transmission to position **P** when the vehicle is stationary. The parking lock should not be used as a brake when parking. Always apply the electronic parking brake in addition to the parking lock in order to secure the vehicle.

In the event of a malfunction of the vehicle's electronics, the transmission may lock in position **P**. Have the vehicle electronics checked immediately at a qualified specialist workshop.

Park position **P** is automatically engaged if:

- you switch off the engine using the SmartKey and remove the SmartKey
- you switch off the engine using the SmartKey or using the Start/Stop button and open the driver's door or front-passenger door
- you open the driver's door when the vehicle is stationary or when driving at a very low speed and the transmission is in position **D** or **R**

R Reverse gear

Only shift the transmission into position **R** when the vehicle is stationary.

N Neutral

Do not shift the transmission to **N** while driving. The automatic transmission could otherwise be damaged.

No power is transmitted from the engine to the drive wheels.

Releasing the brakes will allow you to move the vehicle freely, e.g. to push it or tow it.

If ESP® is deactivated or faulty: shift the transmission to position **N** if the vehicle is in danger of skidding, e.g. on icy roads.

If you switch the engine off with the transmission in position **R** or **D**, the automatic transmission shifts to **N** automatically.

! Coasting in neutral **N** may cause damage to the drive train.

D Drive

The automatic transmission changes gear automatically. All forward gears are available.

Driving tips

Changing gear

The automatic transmission shifts through the individual gears automatically when it is in transmission position **D**. This automatic gear shifting behavior is determined by:

- the selected drive program
- the position of the accelerator pedal
- the road speed

Accelerator pedal position

Your style of driving influences how the automatic transmission shifts gear:

- little throttle: early upshifts
- more throttle: late upshifts

Holding the vehicle stationary on uphill gradients

WARNING

If the clutch overheats, the electronic management system is automatically deactivated. This interrupts the power transmission. The vehicle may, for example, roll backwards on gradients. There is a risk of an accident.

Never hold the vehicle stationary on uphill gradients by depressing the accelerator.

The clutch may overheat if you hold the vehicle stationary on uphill gradients by depressing the accelerator pedal. If the clutch overheats, a warning tone sounds.

The **Stop Vehicle Shift to 'P' Leave Engine Running** display message appears in the multifunction display. You will only be able to continue your journey once the clutch has cooled down and the display message in the multifunction display has disappeared.

Do not hold the vehicle stationary on uphill gradients by depressing the accelerator pedal. Instead, only ever hold the vehicle stationary on uphill gradients by:

- depressing the brake pedal
- activating the HOLD function
- engaging the electric parking brake

Kickdown

Use kickdown for maximum acceleration.

- ▶ Depress the accelerator pedal beyond the pressure point.
The automatic transmission shifts to a lower gear depending on the engine speed.
- ▶ Ease off the accelerator pedal once the desired speed is reached.
The automatic transmission shifts back up.

For further information on kickdown in manual drive program **M** (> page 126).

Rocking the vehicle free

Shifting back and forth between transmission positions **D** and **R** can help to free up the vehicle if it gets stuck in mud or snow. The vehicle's engine management system limits the speed to a maximum of 5 mph (9 km/h) when shifting back and forth. To shift repeatedly

between transmission positions **D** and **R**, move the DIRECT SELECT lever up and down past the point of resistance.

Drive programs

Drive program C (Comfort)

Drive program **C** is characterized by the following:

- the vehicle delivers comfortable, economical handling characteristics.
- the vehicle pulls away more gently in forward and reverse gears, unless the accelerator pedal is depressed fully.
- the vehicle has improved driving stability, for example on slippery road surfaces.
- optimal fuel consumption resulting from the automatic transmission shifting up sooner. The vehicle is driven in the low engine speed range and the wheels are less likely to spin.

Drive program S (Sport)

Drive program **S** is characterized by the following:

- sporty engine settings.
- the automatic transmission shifts up later. The fuel consumption possibly being higher as a result of the later automatic transmission shift points.

Drive program I (Individual)

In drive program **I** the following properties of the drive program can be selected:

- the drive (engine and transmission management)
- the suspension (vehicles with damping system)
- the steering
- the availability of the ECO start/stop function
- the climate control:

Information about configuring drive program **I** with the multimedia system can be found in the Digital Operator's Manual.

- i** To permanently select the gears in drive program **I** using the steering wheel paddle shifters, select the **M** (manual) setting for the drive.

Drive program E (Economy)

Drive program **E** is characterized by the following:

- comfort-oriented engine settings.
- optimal fuel consumption resulting from the automatic transmission shifting up sooner.
- the vehicle pulls away more gently in forward and reverse gears, unless the accelerator pedal is depressed fully.
- the vehicle has improved driving stability, for example on slippery road surfaces.
- the automatic transmission shifting up sooner. This results in the vehicle being driven at lower engine speeds and the wheels being less likely to spin.
- gliding mode is activated automatically when engine-internal conditions are fulfilled and the accelerator is not depressed. At the same time the transmission's clutch opens and the vehicle rolls freely using its kinetic energy. As a result great distances can be completed without the engine brake and fuel consumption reduced.

i The availability of gliding mode depends on various factors, including the following:

- the engine and transmission temperature
- the downhill gradient
- the vehicle speed
- performing regular adaptation functions

When you depress the brake pedal, gliding mode is deactivated, depending on pedal pressure.

When you activate cruise control or Distance Pilot DISTRONIC, gliding mode is not available.

Manual gear shifting

General notes

You can change gear yourself using the steering wheel paddle shifters. The transmission must be in position **D** to do this.

Depending on which steering wheel paddle shifter is pulled, the automatic transmission immediately shifts into the next gear down or up, if permitted.

If you activate manual gearshifting, the multi-function display will show the current gear instead of transmission position **D**.

If manual gearshifting is deactivated, the gears will be selected automatically.

Temporary setting

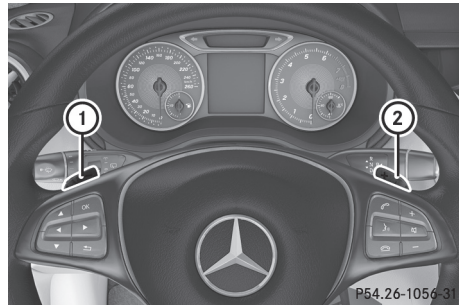

► **To activate:** shift the DIRECT SELECT lever to position **D**.

► Pull steering wheel paddle shifter ① or ②.

Temporary setting will be active for a certain amount of time. Under certain conditions the minimum amount of time is extended, e.g. in the case of lateral acceleration, during an overrun phase or when driving on steep terrain.

► **To deactivate:** pull steering wheel paddle shifter ② and hold it in place.

or

► Use the DIRECT SELECT lever to switch the transmission position.

or

► Use the DYNAMIC SELECT button to change the drive program.

Shifting gears

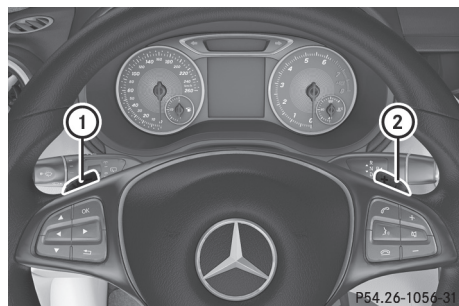

► **To shift up:** pull steering wheel paddle shifter ②.

The automatic transmission shifts up to the next gear.

If the maximum engine speed on the currently engaged gear is reached and you continue to accelerate, the automatic transmission automatically shifts up in order to prevent engine damage.

- ▶ **To shift down:** pull steering wheel paddle shifter ①.

The automatic transmission shifts down to the next gear.

Automatic down shifting occurs when coasting.

If the engine exceeds the maximum engine speed when shifting down, the automatic transmission protects against engine damage by not shifting down.

Shift recommendation



The gearshift recommendations assist you in adopting an economical driving style. The recommended gear is shown in the multifunction display.

- ▶ Shift to recommended gear ② according to gearshift recommendation ① when shown in the multifunction display.

Kickdown

- ▶ For maximum acceleration, depress the accelerator pedal beyond the pressure point. The automatic transmission shifts to a lower gear depending on the engine speed.
- ▶ Shift back up once the desired speed is reached.

During kickdown, you cannot shift gears using the steering wheel paddle shifters.

If you apply full throttle, the automatic transmission shifts up to the next gear when the maximum engine speed is reached. This prevents the engine from overrevving.

Problems with the transmission

| Problem | Possible causes/consequences and ▶ Solutions |
|--|---|
| The transmission has problems shifting gear. | The transmission is losing oil. ▶ Have the transmission checked at a qualified specialist workshop immediately. |
| The acceleration ability is deteriorating. The transmission no longer shifts into all of the gears. Reverse gear can no longer be engaged. | The transmission is in emergency mode. ▶ Stop the vehicle. ▶ Shift the transmission to position P . ▶ Switch off the engine. ▶ Wait at least ten seconds before restarting the engine. ▶ Shift the transmission to position D . ▶ Have the transmission checked at a qualified specialist workshop immediately. |

Refueling

Important safety notes

WARNING

Fuel is highly flammable. If you handle fuel incorrectly, there is a risk of fire and explosion.

You must avoid fire, open flames, creating sparks and smoking. Switch off the engine and, if applicable, the auxiliary heating before refueling.

WARNING

Fuel is poisonous and hazardous to health. There is a risk of injury.

You must make sure that fuel does not come into contact with your skin, eyes or clothing and that it is not swallowed. Do not inhale fuel vapors. Keep fuel away from children.

If you or others come into contact with fuel, observe the following:

- Wash away fuel from skin immediately using soap and water.
- If fuel comes into contact with your eyes, immediately rinse them thoroughly with clean water. Seek medical assistance without delay.
- If fuel is swallowed, seek medical assistance without delay. Do not induce vomiting.
- Immediately change out of clothing which has come into contact with fuel.

WARNING

Electrostatic buildup can create sparks and ignite fuel vapors. There is a risk of fire and explosion.

Always touch the vehicle body before opening the fuel filler flap or touching the fuel pump nozzle. Any existing electrostatic buildup is thereby discharged.

- ❗ Do not use diesel to refuel vehicles with a gasoline engine. Do not switch on the ignition if you accidentally refuel with the wrong fuel. Otherwise, the fuel will enter the fuel system.

Even small amounts of the wrong fuel could result in damage to the fuel system and the engine. Notify a qualified specialist workshop and have the fuel tank and fuel lines drained completely.

- ❗ Overfilling the fuel tank could damage the fuel system.
- ❗ Take care not to spill any fuel on painted surfaces. You could otherwise damage the paintwork.
- ❗ Use a filter when adding fuel from a fuel can. The fuel lines and/or the fuel injection system could otherwise be blocked by particles from the fuel can.

Do not get into the vehicle again during the refueling process. Otherwise, electrostatic charge could build up again.

If you overfill the fuel tank, fuel could spray out when the fuel pump nozzle is removed.

For further information on fuel and fuel quality (> page 295).

Refueling

General information

Pay attention to the important safety notes (> page 127).

The fuel filler flap is unlocked/locked automatically when you unlock/lock the vehicle with the SmartKey.

The position of the fuel filler cap is displayed  in the instrument cluster. The arrow on the filling pump indicates the side of the vehicle.

Opening the fuel filler flap

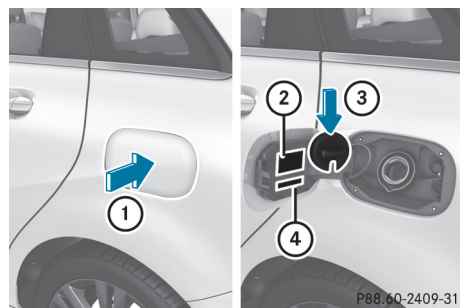

- ① Opens the fuel filler flap
- ② Tire pressure table

- ③ Insert the fuel filler cap
- ④ Instruction label for fuel type to be refueled
- ▶ Switch off the engine.
- ▶ Remove the SmartKey from the ignition lock. or, in vehicles with KEYLESS-GO start-function or KEYLESS-GO
- ▶ Open the driver's door.
The vehicle electronics are now in position . This is the same as the SmartKey having been removed.
- ▶ Press the fuel filler flap in the direction of arrow ①.
The fuel filler flap swings up.
- ▶ Turn the fuel filler cap counterclockwise and remove it.
- ▶ Insert the fuel filler cap into the holder on the inside of fuel filler flap ③.
- ▶ Completely insert the filler neck of the fuel pump nozzle into the tank, hook in place and refuel.
- ▶ Only fill the tank until the pump nozzle switches off.

i Do not add any more fuel after the pump stops filling for the first time. Otherwise, fuel may leak out.

Closing the fuel filler flap

- ▶ Replace the cap on the filler neck and turn clockwise until it engages audibly.
- ▶ Close the fuel filler flap.



Close the fuel filler flap before locking the vehicle.

If you are driving with the fuel filler cap open, the  reserve fuel warning lamp flashes. A message appears in the multifunction display (▷ page 193).

In addition, the  Check Engine warning lamp may light up (▷ page 210).

For further information on warning and indicator lamps in the instrument cluster, see (▷ page 210).

Problems with fuel and the fuel tank

| Problem | Possible causes/consequences and ▶ Solutions |
|--|--|
| Fuel is leaking from the vehicle. | <p>The fuel line or the fuel tank is faulty.</p> <p> WARNING</p> <p>Risk of explosion or fire.</p> <ul style="list-style-type: none"> ▶ Apply the electric parking brake. ▶ Switch off the engine. ▶ Remove the SmartKey from the ignition lock. or, in vehicles with KEYLESS-GO start-function or KEYLESS-GO ▶ Open the driver's door. The vehicle electronics are now in position . This is the same as the SmartKey being removed from the ignition. ▶ Do not restart the engine under any circumstances. ▶ Consult a qualified specialist workshop. |
| The fuel filler flap cannot be opened. | <p>The fuel filler flap is not unlocked.</p> <ul style="list-style-type: none"> ▶ Unlock the vehicle (▷ page 64). |

| Problem | Possible causes/consequences and ► Solutions |
|---------|--|
| | The SmartKey battery is discharged or nearly discharged. ► Unlock the vehicle using the mechanical key (► page 71). |
| | The fuel filler flap is unlocked, but the opening mechanism is jammed. ► Consult a qualified specialist workshop. |

Parking

Important safety notes

WARNING

Flammable material such as leaves, grass or twigs may ignite if they come into contact with hot parts of the exhaust system or exhaust gas flow. There is a risk of fire.

Park the vehicle so that no flammable materials come into contact with parts of the vehicle which are hot. Take particular care not to park on dry grassland or harvested grain fields.

WARNING

If you leave children unsupervised in the vehicle, they could set it in motion by, for example:

- release the parking brake.
- shift the automatic transmission out of the parking position **P**.
- start the engine.

In addition, they may operate vehicle equipment and become trapped. There is a risk of an accident and injury.

When leaving the vehicle, always take the SmartKey with you and lock the vehicle. Never leave children unsupervised in the vehicle.

! Always secure the vehicle correctly against rolling away. Otherwise, the vehicle or its drivetrain could be damaged.

To ensure that the vehicle is secured against rolling away unintentionally:

- the electric parking brake must be applied.
- the transmission must be in position **P** and the transmission position display must show **P** in the multifunction display.

- the SmartKey must be removed from the ignition lock.
- on uphill or downhill gradients, the front wheels must be turned towards the curb.

Switching off the engine

Important safety notes

WARNING

The automatic transmission switches to neutral position **N** when you switch off the engine. The vehicle may roll away. There is a risk of an accident.

After switching off the engine, always switch to parking position **P**. Prevent the parked vehicle from rolling away by applying the parking brake.

Automatic transmission

- Apply the electric parking brake.
- Shift the transmission to position **P**.
- **With the SmartKey** : turn the SmartKey to position **0** in the ignition lock and remove it. The immobilizer is activated.
- **With the Start/Stop button**: press the Start/Stop button (► page 114). The engine stops and all the indicator lamps in the instrument cluster go out.
If the driver's door is closed, this is the same as key position **1**. If the driver's door is open, this is the same as key position **0**, i.e. the SmartKey having been removed.

If you switch the engine off with the transmission in position **R** or **D**, the automatic transmission shifts to **N** automatically.

With the SmartKey: if you then open the driver's door or the front-passenger door or remove

the SmartKey from the ignition, the automatic transmission shifts to **P** automatically.

With the Start/Stop button: if you then open the driver's door or the front-passenger door, the automatic transmission shifts to **P** automatically.

If you want the automatic transmission to remain in neutral **N**, e.g. when having the vehicle cleaned in an automatic car wash with a towing system:

- ▶ **Vehicles with the Start-Stop button:** remove the Start-Stop button from the ignition lock.
- ▶ Insert the SmartKey into the ignition lock.
- ▶ **All vehicles:** switch the ignition on.
- ▶ Depress the brake pedal and keep it depressed.
- ▶ Engage neutral **N**.
- ▶ Release the brake pedal.
- ▶ Release the electric parking brake.
- ▶ Switch off the ignition and leave the SmartKey in the ignition lock.

Electric parking brake

General notes

WARNING

If you leave children unsupervised in the vehicle, they could set it in motion by, for example:

- release the parking brake.
- shift the automatic transmission out of the parking position **P**.
- start the engine.

In addition, they may operate vehicle equipment and become trapped. There is a risk of an accident and injury.

When leaving the vehicle, always take the SmartKey with you and lock the vehicle. Never leave children unsupervised in the vehicle.

The function of the electric parking brake is dependent on the on-board voltage. If the on-board voltage is low or there is a malfunction in the system, it may not be possible to apply the released parking brake.



- ▶ If this is the case, only park the vehicle on level ground and secure it to prevent it rolling away.
- ▶ Shift the automatic transmission to position **P**.

It may not be possible to release an applied parking brake if the on-board voltage is low or there is a malfunction in the system. Contact a qualified specialist workshop.

The electric parking brake performs a function test at regular intervals while the engine is switched off. The sounds that can be heard while this is occurring are normal.

Applying or releasing manually



- ▶ **To engage:** push handle ①.
When the electric parking brake is engaged, the red  indicator lamp lights up in the instrument cluster.
The electric parking brake can also be applied when the SmartKey is removed.
- ▶ **To release:** pull handle ①.
The red  indicator lamp in the instrument cluster goes out.
The electric parking brake can only be released:
 - if the SmartKey is in position **1** or **2** in the ignition lock (▷ page 114) or
 - if the ignition was switched on using the Start/Stop button

Applying automatically

The electric parking brake is automatically applied when the transmission is in position **P** and:

- the engine is switched off or
- the driver is not wearing a seat belt and the driver's door is opened

To prevent the electric parking brake from being automatically applied, pull handle ①.

The electric parking brake is also engaged automatically if:

- Distance Pilot DISTRONIC brings the vehicle to a standstill or
- the HOLD function is keeping the vehicle stationary
- Parking Pilot is keeping the vehicle stationary

In addition, at least one of the following conditions must be fulfilled:

- the engine is switched off
- the driver is not wearing a seat belt and the driver's door is opened
- there is a system malfunction
- the power supply is insufficient
- the vehicle is stationary for a lengthy period

The red  indicator lamp in the instrument cluster goes out.

The electric parking brake is not automatically engaged if the engine is switched off by the ECO start/stop function.

Releasing automatically

Your vehicle's electric parking brake is automatically released if all of the following conditions are met:

- the engine is running.
- the transmission is in position **D** or **R** and you depress the accelerator pedal or shift from position **P** to **D** or **R**
- the seat belt has been fastened.

If the transmission is in position **R**, the tailgate must be closed.

If your seat belt is not fastened, the following conditions must be fulfilled to automatically release the electric parking brake:

- The driver's door is closed.
- You are shifting from transmission position **P** or have previously driven at speeds greater than 2 mph (3 km/h)

Ensure that you do not depress the accelerator pedal unintentionally. Otherwise, the parking brake will be released and the vehicle will start to move.

Emergency braking

The vehicle can also be braked during an emergency by using the electric parking brake.

- ▶ While driving, push handle ① of the electric parking brake (> page 130).

The vehicle is braked as long as you keep handle ① of the electric parking brake pressed. The longer the electric parking brake handle ① is depressed, the greater the braking force.

During braking:

- a warning tone sounds
- the **Release Parking Brake** message appears
- the red  indicator lamp in the instrument cluster flashes

When the vehicle has been braked to a standstill, the electric parking brake is engaged.

Parking the vehicle for a long period

If you leave the vehicle parked for longer than four weeks, the battery may be damaged by exhaustive discharging.

If you leave the vehicle parked for longer than six weeks, the vehicle may suffer damage as a result of lack of use.

- ▶ Visit a qualified specialist workshop and seek advice.

- i** You can obtain information about trickle chargers from a qualified specialist workshop.

Driving tips

General notes

Important safety notes

WARNING

If you switch off the ignition while driving, safety-relevant functions are only available with limitations, or not at all. This could affect,

for example, the power steering and the brake boosting effect. You will require considerably more effort to steer and brake. There is a risk of an accident.

Do not switch off the ignition while driving.

WARNING

If you operate mobile communication equipment when driving, you may be distracted from the traffic situation. You could also lose control of the vehicle. There is a risk of an accident.

Only operate this equipment when the vehicle is stationary.

Observe the legal requirements for the country in which you are driving. Some jurisdictions prohibit the driver from using a mobile phone while driving a vehicle.

If you make a call while driving, always use hands-free mode. Only operate the telephone when the traffic situation permits. If you are unsure, pull over to a safe location and stop before operating the telephone.

Bear in mind that at a speed of only 30 mph (approximately 50 km/h), the vehicle covers a distance of 44 ft (approximately 14 m) per second.

Drive sensibly – save fuel

Observe the following tips to save fuel:

- The tires should always be inflated to the recommended tire pressure.
- Remove unnecessary loads.
- Remove roof racks when they are not needed.
- Warm up the engine at low engine speeds.
- Avoid frequent acceleration or braking.
- Have all maintenance work carried out as indicated by the service intervals in the Maintenance Booklet or by the service interval display.

Fuel consumption also increases when driving in cold weather, in stop-start traffic and in hilly terrain.

Drinking and driving

WARNING

Drinking and driving and/or taking drugs and driving are very dangerous combinations. Even a small amount of alcohol or drugs can affect your reflexes, perceptions and judgment.

The possibility of a serious or even fatal accident is greatly increased when you drink or take drugs and drive.

Do not drink or take drugs and drive or allow anyone to drive who has been drinking or taking drugs.

Emission control

WARNING

Combustion engines emit poisonous exhaust gases such as carbon monoxide. Inhaling these exhaust gases leads to poisoning. There is a risk of fatal injury. Therefore never leave the engine running in enclosed spaces without sufficient ventilation.

Certain engine systems are designed to keep the level of poisonous components in exhaust fumes within legal limits.

These systems only work at peak efficiency if they are serviced exactly in accordance with the manufacturer's specifications. Always have work on the engine carried out at a qualified specialist workshop. Mercedes-Benz recommends that you use an authorized Mercedes-Benz Center for this purpose. In particular, work relevant to safety or on safety-related systems must be carried out at a qualified specialist workshop.

The engine settings must not be changed under any circumstances. Furthermore, all specific service work must be carried out at regular intervals and in accordance with the Mercedes-Benz service requirements. Details can be found in the Maintenance Booklet.

ECO display

Vehicles with a black and white multi-function display

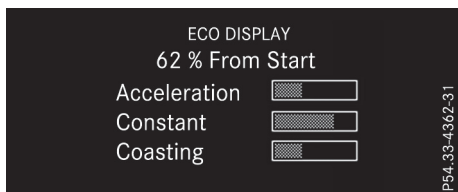

The ECO display provides feedback on how economical your driving characteristics are. The ECO display assists you in achieving the most economical driving style for the selected settings and prevailing conditions. Your driving style can significantly influence the vehicle's consumption.

The ECO display consists of three bars:

- **Acceleration**
- **Constant**
- **Coasting**

The percent value is the average value of the three bars. The three bars and the mean value begin at the value of 50%. A higher percentage indicates a more economical driving style.

The ECO display does not indicate the actual fuel consumption. A fixed percentage count in the ECO display does not indicate a fixed consumption.

Apart from driving style, consumption is dependent on many factors such as, e.g.:

- Load
- Tire pressure
- Cold start
- Choice of route
- Active electrical consumers

These factors are not included in the ECO display.

The evaluation of your driving style is carried out using the following three categories:

- **Acceleration** (evaluation of the acceleration processes):
 - The bar fills up: moderate acceleration, especially at higher speeds
 - The bar empties: sporty acceleration
- **Constant** (assessment of driving behavior at all times):
 - The bar fills up: constant speed and avoidance of unnecessary acceleration and deceleration
 - The bar empties: fluctuations in speed
- **Coasting** (assessment of all deceleration processes):
 - The bar fills up: anticipatory driving, keeping your distance and early release of the accelerator. The vehicle can coast without use of the brakes.
 - The bar empties: frequent braking

An economical driving style specially requires driving at moderate engine speeds.

To achieve a higher value in the categories **Acceleration** and **Constant**:

- observe the gearshift recommendations.
- drive the vehicle in drive program **C** or **E** (vehicles with a DYNAMIC SELECT button).

On long journeys at a constant speed, e.g. on the highway, only the bar for **Constant** will change.

The ECO display summarizes the driving characteristics from the start of the journey to its completion. For this reason, the bars change dynamically at the beginning of the journey. On longer journeys, there are fewer changes. For more dynamic changes, carry out a manual reset.

For more information on the ECO display, see (▷ page 168).

Vehicles with a color multifunction display

The ECO display shows you how economical your driving style is. The ECO display assists you in achieving the most economical driving style for the selected settings and prevailing conditions. Your driving style can significantly influence the vehicle's consumption.

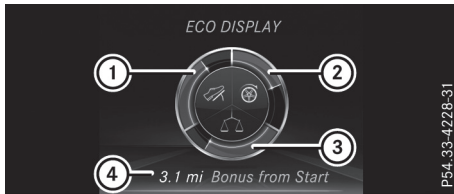

- ① Acceleration
- ② Coasting
- ③ Constant
- ④ Additional range achieved

Range ④ is shown under **Bonus from start** and represents the additional range achieved since the beginning of the journey as a result of an adapted driving style.

If the fuel level has dropped into the reserve range, the **Reserve fuel level** message is shown in the multifunction display instead of range ④. The  warning lamp in the instrument cluster also lights up (> page 210).

The ECO display consists of three sections, with an inner and outer area. The sections correspond to the following three categories:

| | |
|---|--|
| ① | <p>Acceleration (evaluation of the acceleration processes):</p> <ul style="list-style-type: none"> • the outer area fills up and the inner area lights up green: moderate acceleration, especially at higher speeds • the outer area empties and the inner area is gray: sporty acceleration |
| ② | <p>Coasting (evaluation of all deceleration processes):</p> <ul style="list-style-type: none"> • the outer area fills up and the inner area lights up green: anticipatory driving, keeping your distance and early release of the accelerator. The vehicle can coast without use of the brakes. • the outer area empties and the inner area is gray: frequent heavy braking |
| ③ | <p>Constant (continuous evaluation over the entire journey):</p> <ul style="list-style-type: none"> • the outer area fills up and the inner area lights up green: constant speed and avoidance of unnecessary acceleration and deceleration • the outer area empties and the inner area is gray: fluctuations in speed |

The three inner areas display the current driving style and light up green as a result of a particularly economical driving style. Depending on the driving situation, up to two areas may light up simultaneously.

At the beginning of the journey, the three outer areas are empty and fill up as a result of economical driving. A higher level indicates a more economical driving style. If the three outer areas are completely filled at the same time, the driver has adopted the most economical driving style for the selected settings and prevailing conditions. The ECO display border lights up.

The ECO display does not indicate the actual fuel consumption. The additionally achieved range displayed under **Bonus from start** does not indicate a fixed consumption reduction.

In addition to driving style, the actual consumption is affected by other factors, such as:

- Load
- Tire pressure
- Cold start
- Choice of route
- Active electrical consumers

These factors are not included in the ECO display.

An economical driving style specially requires driving at moderate engine speeds.

Achieving a higher value in the categories "Acceleration" and "Constant":

- observe the gearshift recommendations.
- drive the vehicle in drive program **C** or **E** (vehicles with a DYNAMIC SELECT button).

On long journeys at a constant speed, e.g. on the highway, only the outer area for "constant" will change.

The ECO display summarizes the driving style from the start of the journey to its completion. Therefore, there are more marked changes in the outer areas at the start of a journey. On longer journeys, there are fewer changes. For more marked changes, perform a manual rest (▷ page 169).

For more information on the ECO display, see (▷ page 168).

Braking

Important safety notes

WARNING

If you shift down on a slippery road surface in an attempt to increase the engine's braking effect, the drive wheels could lose their grip. There is an increased danger of skidding and accidents.

Do not shift down for additional engine braking on a slippery road surface.

Downhill gradients

- ❗ On long and steep gradients, you must reduce the load on the brakes by shifting to a lower gear in good time. This allows you to take advantage of engine braking. For this you must first activate manual gearshifting. This

helps you to avoid overheating the brakes and wearing them out excessively.

When you take advantage of engine braking, it is possible that a drive wheel will not rotate for some time, e.g. on a slippery road surface. This could cause damage to the drive train. This type of damage is not covered by the Mercedes-Benz warranty.

Briefly depressing the accelerator pedal on downhill gradients while the manual drive program **M** is temporarily activated: the automatic transmission may switch to the last active automatic drive program **E** or **S**. The automatic transmission may shift to a higher gear. This can reduce the engine's braking effect.

Heavy and light loads

WARNING

If you rest your foot on the brake pedal while driving, the braking system can overheat. This increases the stopping distance and can even cause the braking system to fail. There is a risk of an accident.

Never use the brake pedal as a footrest. Never depress the brake pedal and the accelerator pedal at the same time.

- ❗ Depressing the brake pedal constantly results in excessive and premature wear to the brake pads.

If the brakes have been subjected to a heavy load, do not stop the vehicle immediately. Drive on for a short while. This allows the airflow to cool the brakes more quickly.

Wet roads

If you have driven for a long time in heavy rain without braking, there may be a delayed reaction from the brakes when braking for the first time. This may also occur after the vehicle has been washed or driven through deep water. You have to depress the brake pedal more firmly. Maintain a greater distance from the vehicle in front.

After driving on a wet road or having the vehicle washed, brake firmly while paying attention to the traffic conditions. This will warm up the brake discs, thereby drying them more quickly and protecting them against corrosion.

Limited braking performance on salt-treated roads

If you drive on salted roads, a layer of salt residue may form on the brake discs and brake pads. This can result in a significantly longer braking distance.

- In order to prevent any salt build-up, apply the brakes occasionally while paying attention to the traffic conditions.
- Carefully depress the brake pedal at the beginning and end of a journey.
- Maintain a greater distance to the vehicle ahead.

Servicing the brakes

! The brake fluid level may be too low, if:

- if the red brake warning lamp lights up in the instrument cluster and
- you hear a warning tone while the engine is running

Observe additional warning messages in the multifunction display.

The brake fluid level may be too low due to brake pad wear or leaking brake lines.

Have the brake system checked immediately. Consult a qualified specialist workshop to arrange this.

! A function or performance test should only be carried out on a 2-axle dynamometer. If you wish to operate the vehicle on such a dynamometer, please consult a qualified specialist workshop in advance. You could otherwise damage the drive train or the brake system.

! As the ESP® system operates automatically, the engine and the ignition must be switched off (the SmartKey must be in position **0** or **1** in the ignition lock), if the electric parking brake is tested on a braking dynamometer (maximum 10 seconds).

Braking triggered automatically by ESP® may cause severe damage to the brake system.

All checks and maintenance work on the brake system must be carried out at a qualified specialist workshop.

Have brake pads installed and brake fluid replaced at a qualified specialist workshop.

If the brake system has only been subject to moderate loads, you should test the functionality of your brakes at regular intervals.

You can find a description of Brake Assist (BAS) on (▷ page 57).

Mercedes-Benz recommends that you only have brake pads/linings installed on your vehicle which have been approved for Mercedes-Benz vehicles or which correspond to an equivalent quality standard. Brake pads/linings which have not been approved for Mercedes-Benz vehicles or which are not of an equivalent quality could affect your vehicle's operating safety.

Mercedes-Benz recommends that you only use brake fluid that has been specially approved for your vehicle by Mercedes-Benz, or which corresponds to an equivalent quality standard. Brake fluid which has not been approved for Mercedes-Benz vehicles or which is not of an equivalent quality could affect your vehicle's operating safety.

Checking brake lining thickness

You can measure the brake pad/lining thickness using a test gage. Color-coding (green or red) on the test gage allows you to determine whether the brake pad/lining thickness is still sufficient. The test gage is in the vehicle document wallet in the glove box.

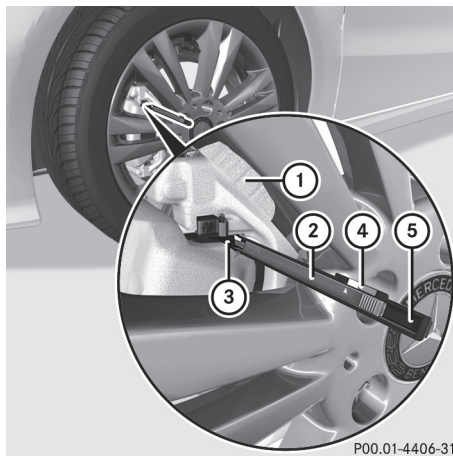

Front wheel

P00.01-4406-31

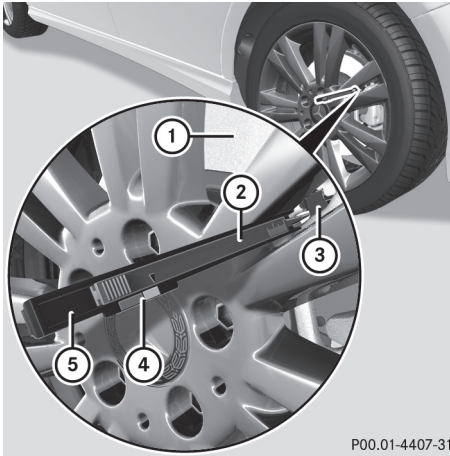

P00.01-4407-31

Rear wheel

- ▶ Bring the vehicle and wheels into a suitable position so that you can attach test gage ⑤.
- ▶ Secure the vehicle against rolling away (> page 129).
- ▶ Engage park position **P**.
- ▶ Switch off the engine.
- ▶ Place test gage ⑤ between the wheel's spokes on brake pad/lining ③.
- ▶ Hold test gage ⑤ vertically on brake disc ① and slide measuring pin ② onto brake disc ①.
- ▶ Check which color field ④ the arrow on measuring pin ② is pointing to.
Green: the brake pad/lining thickness is sufficient.

Red: the brake pad/lining thickness is not sufficient. Have the brake pads/lining checked at a qualified specialist workshop.

To avoid an inaccurate measurement:

- make sure you position the wheels suitably
- do not put the measuring pin on a recess in the brake disc

Driving on wet roads

Aquaplaning

If the road surface is wet, aquaplaning may occur depending on water level, speed and tire tread depth.

For this reason, in the event of heavy rain or in conditions in which hydroplaning may occur, you must drive in the following manner:

- lower your speed
- avoid ruts
- avoid sudden steering movements
- brake carefully

Driving on flooded roads

- ❗ Do not drive through flooded areas. Check the depth of any water before driving through it. Drive slowly through standing water. Otherwise, water could enter the vehicle interior or engine compartment. It can then damage the engine's or automatic transmission's electronic components. It can also be sucked in by the engine's air intake connection and cause engine damage.

Winter driving

⚠ WARNING

If you shift down on a slippery road surface in an attempt to increase the engine's braking effect, the drive wheels could lose their grip. There is an increased danger of skidding and accidents.

Do not shift down for additional engine braking on a slippery road surface.

⚠ DANGER

If the exhaust pipe is blocked or adequate ventilation is not possible, poisonous gases such as carbon monoxide (CO) may enter the vehicle. This is the case, e.g. if the vehicle becomes trapped in snow. There is a risk of fatal injury.

If you leave the engine or the auxiliary heating running, make sure the exhaust pipe and area around the vehicle are clear of snow. To ensure an adequate supply of fresh air, open a window on the side of the vehicle that is not facing into the wind.

Have your vehicle winter-proofed at a qualified specialist workshop at the onset of winter.

Drive particularly carefully on slippery road surfaces. Avoid sudden acceleration, steering and braking maneuvers. Do not use cruise control or Distance Pilot DISTRONIC.

If the vehicle threatens to skid or cannot be stopped when moving at low speed:

- ▶ Shift the transmission to position **N**.
- ▶ Try to bring the vehicle under control using corrective steering.

The outside temperature indicator is not designed to serve as an ice-warning device and is therefore unsuitable for that purpose. Changes in the outside temperature are displayed after a short delay.

Indicated temperatures just above the freezing point do not guarantee that the road surface is free of ice. The road may still be icy, especially in wooded areas or on bridges.

You should pay special attention to road conditions when temperatures are around freezing point.

For more information on driving with snow chains, see (▷ page 272).

For more information on driving with summer tires, see (▷ page 271).

Observe the notes in the "Winter operation" section (▷ page 271).

Driving systems

Cruise control

General notes

Cruise control maintains a constant road speed for you. It brakes automatically in order to avoid exceeding the set speed. On long and steep downhill gradients, especially if the vehicle is laden, you must select a low gear in good time. You need to shift manually using the steering wheel paddle shifters beforehand. By doing so, you will make use of the braking effect of the engine. This relieves the load on the brake system and prevents the brakes from overheating and wearing too quickly.

When the engine is running, you can use the cruise control lever to limit the speed to any speed between 20 mph (30 km/h) and the technically permitted maximum speed of the vehicle. Use cruise control if road and traffic conditions make it appropriate to maintain a steady speed for a prolonged period.

The speed indicated in the speedometer may differ slightly from the speed stored.

Important safety notes

If you fail to adapt your driving style, cruise control can neither reduce the risk of an accident nor override the laws of physics. Cruise control cannot take into account the road, traffic and weather conditions. Cruise control is only an aid. You are responsible for the distance to the vehicle in front, for vehicle speed, for braking in good time and for staying in your lane.

Do not use cruise control:

- in road and traffic conditions which do not allow you to maintain a constant speed, e.g. in heavy traffic or on winding roads
- on slippery road surfaces. Braking or accelerating could cause the drive wheels to lose traction and the vehicle could then skid
- in poor visibility, e.g. due to fog, heavy rain or snow

If there is a change of drivers, advise the new driver of the speed stored.

Cruise control lever

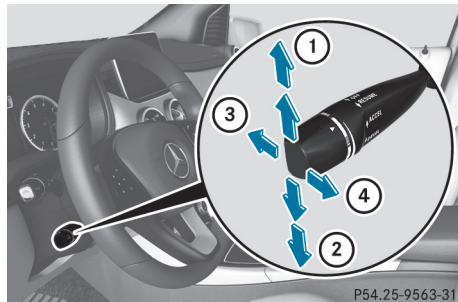

- ① Activates or increases speed
- ② Activates or reduces speed
- ③ Deactivates cruise control
- ④ Activates at the current speed/last stored speed

When you activate cruise control, the stored speed is shown in the multifunction display for five seconds.

Activation conditions

To activate cruise control, all of the following activation conditions must be fulfilled:

- the electric parking brake must be released.
- ESP® must be active, but not intervening.
- the transmission must be in position **D**.

Storing, maintaining and calling up a speed

Storing and maintaining the current speed

You can store the current speed if you are driving faster than 20 mph (30 km/h).

- ▶ Accelerate the vehicle to the desired speed.
- ▶ Briefly press the cruise control lever up ① or down ②.
- ▶ Remove your foot from the accelerator pedal. Cruise control is activated. The vehicle automatically maintains the stored speed.

- ❗ Cruise control may be unable to maintain the stored speed on uphill gradients. The stored speed is resumed when the gradient evens out. Cruise control maintains the stored speed on downhill gradients by automatically applying the brakes.

Storing the current speed or calling up the last stored speed

WARNING

If you call up the stored speed and it differs from the current speed, the vehicle accelerates or decelerates. If you do not know the stored speed, the vehicle could accelerate or brake unexpectedly. There is a risk of an accident.

Pay attention to the road and traffic conditions before calling up the stored speed. If you do not know the stored speed, store the desired speed again.

- ▶ Briefly pull the cruise control lever towards you ④.
- ▶ Remove your foot from the accelerator pedal. The first time cruise control is activated, it stores the current speed or regulates the speed of the vehicle to the previously stored speed.

Setting a speed

Keep in mind that it may take a brief moment until the vehicle has accelerated or braked to the speed set.

- ▶ **To adjust the set speed in 5 mph increments (10 km/h increments):** briefly press the cruise control lever up ① past the pressure point for a higher speed, or down ② for a lower speed.

- ▶ **To adjust the set speed in 1 mph increments (1 km/h increments):** briefly press the cruise control lever up ① to the pressure point for a higher speed, or down ② for a lower speed.

- ❗ Cruise control is not deactivated if you depress the accelerator pedal. For example, if you accelerate briefly to overtake, cruise control adjusts the vehicle's speed to the last speed stored after you have finished overtaking.

Deactivating cruise control

There are several ways to deactivate cruise control:

- ▶ Briefly press the cruise control lever forwards ③.

or

- ▶ Brake.

Cruise control is automatically deactivated if:

- the vehicle is secured with the electric parking brake
- you are driving at less than 20 mph (30 km/h)
- ESP® intervenes or you deactivate ESP®
- you shift the transmission to position **N** while driving

If cruise control is deactivated, you will hear a warning tone. You will see the **Cruise Control Off** message in the multifunction display for approximately five seconds.

- ❗ When you switch off the engine, the last speed stored is cleared.

Distance Pilot DISTRONIC

General notes

Distance Pilot DISTRONIC regulates the speed and automatically helps you maintain the distance to the vehicle detected in front. Vehicles are detected with the aid of the radar sensor system. Distance Pilot DISTRONIC brakes automatically to avoid exceeding the set speed or to maintain the designated distance from the vehicle in front.

If Distance Pilot DISTRONIC detects that there is a risk of a collision, you will be warned visually and acoustically. Without your intervention, Distance Pilot DISTRONIC cannot prevent a collision. An intermittent warning tone will then sound and the distance warning lamp will light up in the instrument cluster. Brake immediately in order to increase the distance to the vehicle in front or take evasive action provided it is safe to do so.

Distance Pilot DISTRONIC operates in the range between 0 mph (0 km/h) and 120 mph (200 km/h).

Change into a lower gear in good time on long and steep downhill gradients. This is especially important if the vehicle is laden. By doing so, you will make use of the braking effect of the engine. This relieves the load on the brake system and prevents the brakes from overheating and wearing too quickly.

Do not use Distance Pilot DISTRONIC on roads with steep gradients.

For Distance Pilot DISTRONIC to assist you when driving, the radar sensor system must be operational.

Since Distance Pilot DISTRONIC transmits radar waves, it can resemble the radar detectors of the responsible authorities. You can refer to the relevant chapter in the Operator's Manual if questions are asked about this.

i USA only: This device has been approved by the FCC as a "Vehicular Radar System". The radar sensor is intended for use in an automotive radar system only. Removal, tampering, or altering of the device will void any warranties, and is not permitted by the FCC. Do not tamper with, alter, or use in any non-approved way.

Any unauthorized modification to this device could void the user's authority to operate the equipment.

i Canada only: This device complies with RSS-210 of Industry Canada. Operation is subject to the following two conditions:

1. This device may not cause interference, and
2. This device must accept any interference received, including interference that may cause undesired operation of the device.

Removal, tampering, or altering of the device will void any warranties, and is not permitted. Do not tamper with, alter, or use in any non-approved way.

Any unauthorized modification to this device could void the user's authority to operate the equipment.

Important safety notes

WARNING

Distance Pilot DISTRONIC does not react to:

- people or animals
- stationary objects on the road, e.g. stopped or parked vehicles
- oncoming vehicles and crossing traffic

As a result, Distance Pilot DISTRONIC may neither give warnings nor intervene in such situations. There is a risk of an accident.

Always pay careful attention to the traffic situation and be ready to brake.

WARNING

Distance Pilot DISTRONIC cannot always clearly identify other road users and complex traffic situations.

In such cases, Distance Pilot DISTRONIC may:

- give an unnecessary warning and then brake the vehicle
- neither give a warning nor intervene
- accelerate or brake unexpectedly

There is a risk of an accident.

Continue to drive carefully and be ready to brake, especially if Distance Pilot DISTRONIC warns you.

⚠ WARNING

Distance Pilot DISTRONIC brakes your vehicle with up to 50% of the maximum possible deceleration. If this deceleration is not sufficient, Distance Pilot DISTRONIC alerts you with a visual and acoustic warning. There is a risk of an accident.

Apply the brakes yourself in these situations and try to take evasive action.

! When Distance Pilot DISTRONIC or the HOLD function is activated, the vehicle brakes automatically in certain situations.

To avoid damage to the vehicle, deactivate Distance Pilot DISTRONIC and the HOLD function in the following or similar situations:

- when towing the vehicle
- in the car wash

If you fail to adapt your driving style, Distance Pilot DISTRONIC can neither reduce the risk of an accident nor override the laws of physics. Distance Pilot DISTRONIC cannot take into account road, weather or traffic conditions. Distance Pilot DISTRONIC is only an aid. You are responsible for the distance to the vehicle in front, for vehicle speed, for braking in good time and for staying in your lane.

Do not use Distance Pilot DISTRONIC:

- in road and traffic conditions which do not allow you to maintain a constant speed, e.g. in heavy traffic or on winding roads
- on slippery road surfaces. Braking or accelerating could cause the drive wheels to lose traction and the vehicle could then skid
- when there is poor visibility, e.g. due to fog, heavy rain or snow

Distance Pilot DISTRONIC may not detect narrow vehicles driving in front, e.g. motorcycles, or vehicles driving on a different line.

In particular, the detection of obstacles can be impaired if:

- there is dirt on the sensors or anything else covering the sensors
- there is snow or heavy rain
- there is interference by other radar sources
- there are strong radar reflections, for example, in parking garages

If Distance Pilot DISTRONIC no longer detects a vehicle in front, it may unexpectedly accelerate to the speed stored.

This speed may:

- be too high if you are driving in a filter lane or an exit lane
- be so high when driving in the right-hand lane that you overtake vehicles in the left-hand lane
- be so high in the left lane that you pass vehicles driving in the right lane

If there is a change of drivers, advise the new driver of the speed stored.

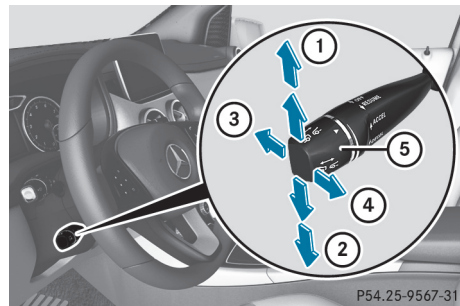
Cruise control lever

- ① Stores the current speed or a higher speed
- ② Stores the current speed or a lower speed
- ③ Deactivates Distance Pilot DISTRONIC
- ④ Stores the current speed or calls up the last stored speed
- ⑤ Sets a specified minimum distance

Activating Distance Pilot DISTRONIC**Activation conditions**

! When Distance Pilot DISTRONIC or the HOLD function is activated, the vehicle brakes automatically in certain situations.

To avoid damage to the vehicle, deactivate Distance Pilot DISTRONIC and the HOLD function in the following or similar situations:

- when towing the vehicle
- in the car wash

To activate Distance Pilot DISTRONIC, the following conditions must be fulfilled:

- the engine must be started. It may take up to two minutes of driving before Distance Pilot DISTRONIC is ready for use.
- the electric parking brake must be released.
- ESP® must be active, but not intervening.
- Parking Pilot must not be activated.
- the transmission must be in position **D**.
- the driver's door must be closed when you shift from **P** to **D** or your seat belt must be fastened.
- the front-passenger door must be closed.
- the vehicle must not skid.

Activating

- ▶ Briefly pull the cruise control lever towards you ④, up ① or down ②. Distance Pilot DISTRONIC is activated.
- ▶ Keep the cruise control lever pressed up ① or down ② until the desired speed is set.
- ▶ Remove your foot from the accelerator pedal. Your vehicle adapts its speed to that of the vehicle in front, but only up to the desired stored speed.

i If you do not fully release the accelerator pedal, the **Distance Pilot Suspended** message appears in the multifunction display. The set distance to a slower-moving vehicle in front will then not be maintained. You will be driving at the speed you determine by the position of the accelerator pedal.

You can also activate Distance Pilot DISTRONIC when stationary. The lowest speed that can be set is 20 mph (30 km/h).

Driving with Distance Pilot DISTRONIC

Activating at the current speed/last stored speed

WARNING

If you call up the stored speed and it differs from the current speed, the vehicle accelerates or decelerates. If you do not know the stored speed, the vehicle could accelerate or brake unexpectedly. There is a risk of an accident.

Pay attention to the road and traffic conditions before calling up the stored speed. If you

do not know the stored speed, store the desired speed again.

- ▶ Briefly pull the cruise control lever towards you ④.
- ▶ Remove your foot from the accelerator pedal. The first time Distance Pilot DISTRONIC is activated, it stores the current speed or regulates the speed of the vehicle to the previously stored speed.

Pulling away and driving

- ▶ **If you want to pull away with Distance Pilot DISTRONIC:** remove your foot from the brake pedal.
- ▶ Briefly pull the cruise control lever towards you ④.

or

- ▶ **If Distance Pilot DISTRONIC is activated:** accelerate briefly. Your vehicle pulls away and adapts its speed to that of the vehicle in front. If no vehicle is detected in front, your vehicle accelerates to the set speed.

The vehicle can also pull away when it is facing an unidentified obstacle or is driving on a different line from another vehicle. The vehicle then brakes automatically. Be ready to brake at all times.

If there is no vehicle in front, Distance Pilot DISTRONIC operates in the same way as cruise control.

If Distance Pilot DISTRONIC detects a slower-moving vehicle in front, it brakes your vehicle. In this way, the distance you have selected is maintained.

If Distance Pilot DISTRONIC detects a faster-moving vehicle in front, it increases the driving speed. However, the vehicle is only accelerated up to the speed you have stored.

i Distance Pilot DISTRONIC is deactivated when you depress the brake, except when the vehicle is stationary.

Selecting the drive program

Distance Pilot DISTRONIC supports a sporty driving style when you select the **S** drive program (▷ page 124) or the manual drive program (▷ page 125). Acceleration behind the vehicle in front or to the set speed is then noticeably more dynamic. If you have selected the **E** driving program, the vehicle accelerates more gently. This

setting is recommended in stop-and-start traffic.

Changing lanes

If when driving on multilane roads you wish to change to the overtaking lane, Distance Pilot DISTRONIC supports you if:

- you are driving faster than 45 mph (70 km/h)
- Distance Pilot DISTRONIC is maintaining the distance to a vehicle in front
- you switch on the appropriate turn signal
- Distance Pilot DISTRONIC does not currently detect a danger of collision

If these conditions are fulfilled, your vehicle is accelerated. Acceleration will be interrupted if changing lanes takes too long or if the distance between your vehicle and the vehicle in front becomes too small.

Stopping

If Distance Pilot DISTRONIC detects that the vehicle in front is stopping, it brakes your vehicle until it is stationary.

Once your vehicle is stationary, it remains stationary and you do not need to depress the brake.

- i** After a time, the electric parking brake secures the vehicle and relieves the service brake.
- i** Depending on the specified minimum distance, your vehicle will come to a standstill at a sufficient distance behind the vehicle in front. The specified minimum distance is set using the control on the cruise control lever.

When Distance Pilot DISTRONIC is activated, the transmission is shifted automatically to position **P** if:

- the driver's seat belt is not fastened and the driver's door is open.
- the engine is switched off, unless it is automatically switched off by the ECO start/stop function.

The electric parking brake secures the vehicle automatically if Distance Pilot DISTRONIC is activated when the vehicle is stationary and:

- a system malfunction occurs.
- the power supply is insufficient.

If a malfunction occurs, the transmission may also shift to position **P** automatically.

Setting a speed

Keep in mind that it may take a brief moment until the vehicle has accelerated or braked to the speed set.

- ▶ Press the cruise control lever up **①** for a higher speed or down **②** for a lower speed.
- ▶ **To adjust the set speed in 1 mph increments (1 km/h increments):** briefly press the cruise control lever up **①** or down **②** to the pressure point.
The last stored speed increases or decreases in 1 mph (1 km/h) increments.
- ▶ **To adjust the set speed in 5 mph increments (10 km/h increments):** briefly press the cruise control lever up **①** or down **②** beyond the pressure point.
The last stored speed increases or decreases in 5 mph (10 km/h) increments.

- i** Distance Pilot DISTRONIC is not deactivated if you depress the accelerator pedal. If you accelerate to overtake, Distance Pilot DISTRONIC adjusts the vehicle's speed to the last speed stored after you have finished overtaking.

Setting a specified minimum distance

You can set the specified minimum distance for Distance Pilot DISTRONIC by varying the time span between one and two seconds. With this function you can set the minimum distance that Distance Pilot DISTRONIC maintains to the vehicle in front, dependent on vehicle speed. You can see this distance in the multifunction display (▷ page 148).

The specified minimum distance can be changed while Distance Pilot DISTRONIC is switched on or off.

- i** Make sure that you maintain the minimum distance to the vehicle in front as required by law. Adjust the distance to the vehicle in front if necessary.

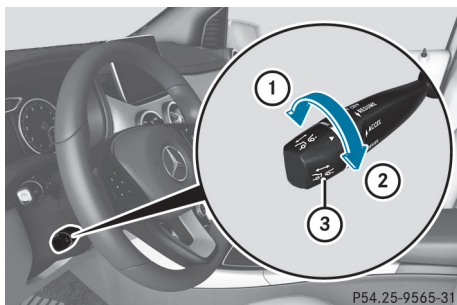

- ▶ **To increase:** turn control ③ in direction ②. Distance Pilot DISTRONIC then maintains a greater distance between your vehicle and the vehicle in front.
- ▶ **To decrease:** turn control ③ in direction ①. Distance Pilot DISTRONIC then maintains a shorter distance between your vehicle and the vehicle in front.

Deactivating Distance Pilot DISTRONIC

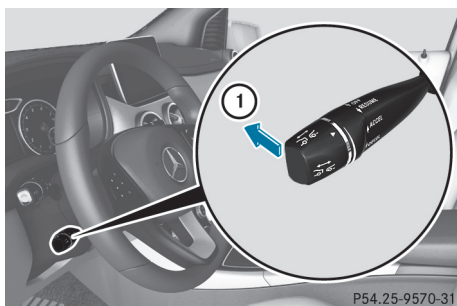

There are several ways to deactivate Distance Pilot DISTRONIC:

- ▶ Briefly press the cruise control lever forwards ①.
- or
- ▶ Brake, unless the vehicle is stationary
- ▶ Briefly press the cruise control lever forwards ①.
- or
- ▶ Brake, unless the vehicle is stationary

When you deactivate Distance Pilot DISTRONIC, the **Distance Pilot Off** message appears in the multifunction display for approximately five seconds.

- ❗ The last speed stored remains stored until you switch off the engine. Distance Pilot

DISTRONIC is not deactivated if you depress the accelerator pedal.

Distance Pilot DISTRONIC is automatically deactivated if:

- you engage the electric parking brake or if the vehicle is automatically secured with the electric parking brake
- ESP® intervenes or you deactivate ESP®
- the transmission is in position **P**, **R** or **N**
- you pull the cruise control lever towards you in order to pull away and the front-passenger door or one of the rear doors is open
- the vehicle is skidding
- you switch on Parking Pilot

If Distance Pilot DISTRONIC is automatically deactivated, you will hear a warning tone. The **Distance Pilot Off** message appears in the multifunction display for approximately five seconds.

Distance Pilot DISTRONIC is also automatically deactivated when you activate DSR. The  DSR symbol appears in the multifunction display.

Distance Pilot DISTRONIC displays in the instrument cluster

Displays in the speedometer



When Distance Pilot DISTRONIC PLUS is activated and there are no vehicles detected in front, one or two segments ② in the set speed range light up.

If Distance Pilot DISTRONIC detects a vehicle in front, segments ② between speed of the vehicle in front ③ and stored speed ① light up.

- ❗ For design reasons, the speed displayed in the speedometer may differ slightly from the speed set for Distance Pilot DISTRONIC.

Display when Distance Pilot DISTRONIC is deactivated

Vehicles with a black and white multifunction display: you can select the distance display function using the on-board computer.

Vehicles with a color multifunction display: in the Assistance menu of the on-board computer, you can select the assistance graphic.

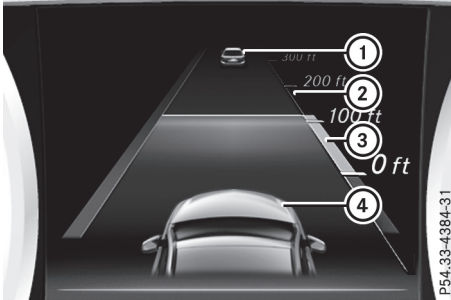

- ① Vehicle in front, if detected
- ② Distance indicator, current distance to the vehicle in front
- ③ Specified minimum distance to the vehicle in front; adjustable
- ④ Your vehicle

► **Vehicles with color multifunction display:** select the **Assistance Graphic** function using the on-board computer (> page 173).

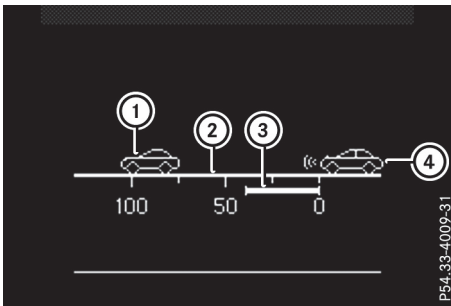

Distance display in vehicles with a black and white multifunction display

- ① Vehicle in front, if detected
- ② Distance indicator, current distance to the vehicle in front
- ③ Specified minimum distance to the vehicle in front; adjustable
- ④ Your vehicle

► **Vehicles with black and white multifunction display:** select the **Distance Display**

function using the on-board computer (> page 173).

Display when Distance Pilot DISTRONIC is activated

You will initially see the stored speed for about five seconds when you activate Distance Pilot DISTRONIC.

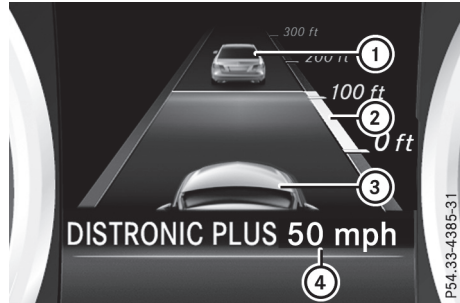

- ① Vehicle in front, if detected
- ② Specified minimum distance to the vehicle in front; adjustable
- ③ Your vehicle
- ④ Distance Pilot DISTRONIC active (text only appears when the cruise control lever is actuated)

► **Vehicles with color multifunction display:** select the **Assistance Graphic** function using the on-board computer (> page 173).

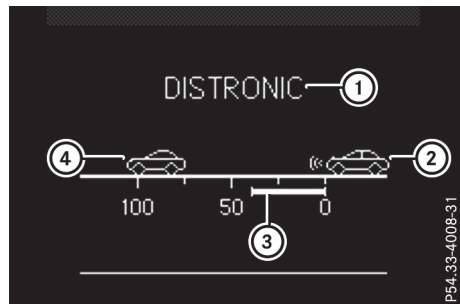

Distance display in vehicles with a black and white multifunction display

- ① Distance Pilot DISTRONIC activated
- ② Your vehicle
- ③ Specified minimum distance to the vehicle in front; adjustable
- ④ Vehicle in front, if detected

► **Vehicles with black and white multifunction display:** select the **Distance Display**

function using the on-board computer (> page 173).

Tips for driving with Distance Pilot DISTRONIC

General notes

Pay particular attention in the following traffic situations:

- Cornering, entering and exiting a bend: the ability of Distance Pilot DISTRONIC to detect vehicles during cornering is limited. Your vehicle may brake unexpectedly or late.
- Driving on a different line: Distance Pilot DISTRONIC may not detect vehicles which are not driving in the middle of their lane. The distance to the vehicle in front will be too short.
- Other vehicles changing lanes: Distance Pilot DISTRONIC has not detected the vehicle cutting in yet. The distance to this vehicle will be too short.
- Narrow vehicles: Distance Pilot DISTRONIC has not yet detected the vehicle in front on the edge of the road because of its narrow width. The distance to the vehicle in front will be too short.
- Obstacles and stationary vehicles: Distance Pilot DISTRONIC does not brake for obstacles or stationary vehicles. If, for example, the detected vehicle turns a corner and an obstacle or stationary vehicle is then revealed, Distance Pilot DISTRONIC will not brake for them.
- Distance Pilot DISTRONIC may mistakenly detect vehicles that are crossing your lane. If you activate Distance Pilot DISTRONIC in the following situations, the vehicle could pull away unintentionally:
 - At traffic lights with crossing traffic, for example.
 - With a vehicle ahead on the other side of an intersection and the HOLD function active.

In such situations, brake if necessary. Distance Pilot DISTRONIC will then be deactivated.

HOLD function

General notes

The HOLD function can assist the driver in the following situations:

- when pulling away, especially on steep slopes
- when maneuvering on steep slopes
- when waiting in traffic

The vehicle is kept stationary without the driver having to depress the brake pedal.

The braking effect is canceled and the HOLD function deactivated when you depress the accelerator pedal to pull away.

Important safety notes

WARNING

If the vehicle is only braked using the HOLD function, the vehicle may roll away in the following situations when you leave the vehicle:

- if there is a malfunction in the system or in the voltage supply
- if the HOLD function is deactivated by depressing the accelerator pedal or brake pedal, e.g. by a vehicle occupant
- if the electrical system in the engine compartment, the battery or the fuses are tampered with or the battery is disconnected

There is a risk of an accident.

Always deactivate the HOLD function and secure the vehicle against rolling away before you leave it.

I When Distance Pilot DISTRONIC or the HOLD function is activated, the vehicle brakes automatically in certain situations. To avoid damage to the vehicle, deactivate Distance Pilot DISTRONIC and the HOLD function in the following or similar situations:

- when towing the vehicle
- in the car wash

Deactivating the HOLD function (> page 147).

Activation conditions

You can activate the HOLD function if:

- the vehicle is stationary
- the engine is running or if it has been automatically switched off by the ECO start/stop function
- the driver's door is closed or your seat belt is fastened
- the electric parking brake is released
- Distance Pilot DISTRONIC is deactivated
- the transmission is in position **D**, **R** or **N** on vehicles with automatic transmission

Activating the HOLD function



- ▶ Make sure that the activation conditions are met.
- ▶ Depress the brake pedal.
- ▶ Quickly depress the brake pedal further until ① appears in the multifunction display. The HOLD function is activated. You can release the brake pedal.

i If depressing the brake pedal the first time does not activate the HOLD function, wait briefly and then try again.

Deactivating the HOLD function

The HOLD function is deactivated automatically if:

- you accelerate. On vehicles with automatic transmission: only when the transmission is in position **D** or **R**.
- the transmission is in position **P** on vehicles with automatic transmission.
- you depress the brake pedal again with a certain amount of pressure until ① disappears from the multifunction display.
- you activate Distance Pilot DISTRONIC.
- you secure the vehicle using the electric parking brake.

i After a time, the electric parking brake secures the vehicle and relieves the service brake.

When the HOLD function is activated, the transmission is automatically shifted to position **P** if:

- the driver's seat belt is not fastened and the driver's door is open
- the engine is switched off, unless it is automatically switched off by the ECO start/stop function

The electric parking brake secures the vehicle automatically if the HOLD function is activated when the vehicle is stationary and:

- a system malfunction occurs
- the power supply is insufficient

Start-off Assist

Important safety notes

⚠ WARNING

If you use start-off assist, individual wheels may start to spin and the vehicle may skid. If ESP® is deactivated, there is a greater danger of skidding and having an accident. Make sure that no persons or obstacles are in the vicinity of the vehicle.

Start-off assist enables optimum acceleration from a standstill. For this, a suitably high-grip road surface is required and the vehicle and tires must be in good working order.

Do not activate start-off assist on public roads. Observe the safety notes on driving safety systems (> page 56).

Be sure to read the safety notes and information on ESP® (> page 60).

Activating start-off assist

- ▶ Deactivate ESP® (> page 173).
- ▶ Turn the steering wheel to the straight-ahead position.
- ▶ Firmly depress the brake pedal with your left foot and keep it depressed.
- ▶ Shift the transmission to position **D**.
- ▶ Use the DYNAMIC SELECT button to select the **S** drive program (> page 120).

- ▶ Quickly depress the accelerator pedal fully.
- ▶ Take your foot off the brake, but keep the accelerator pedal depressed.
The vehicle pulls away at maximum acceleration.
- ❗ Activate ESP® as soon as the acceleration process has ended. ESP® will otherwise not be able to stabilize the vehicle if the vehicle starts to skid or a wheel starts to spin.

Canceling start-off assist

- ▶ Remove your foot from the accelerator pedal.
- ▶ Reactivate ESP®.

4MATIC

❗ Never tow the vehicle with one axle raised. This may damage the differential. Damage of this sort is not covered by the Mercedes-Benz Limited Warranty. All wheels must remain either on the ground or be fully raised. Observe the instructions for towing the vehicle with all wheels in full contact with the ground.

4MATIC, together with ESP®, improves the traction of your vehicle whenever a drive wheel spins due to insufficient grip.

If you fail to adapt your driving style, 4MATIC can neither reduce the risk of accident nor override the laws of physics. 4MATIC cannot take account of road, weather and traffic conditions. 4MATIC is only an aid. You are responsible for the distance to the vehicle in front, for vehicle speed, for braking in good time and for staying in your lane.

If a drive wheel spins due to insufficient grip:

- Only depress the accelerator pedal as far as necessary when pulling away.
- Accelerate less when driving.

❗ In wintry driving conditions, the maximum effect of 4MATIC can only be achieved if you use winter tires (M+S tires), with snow chains if necessary.

DYNAMIC BODY CONTROL

General notes

DYNAMIC BODY CONTROL offers improved driving comfort and continuously controls the calibration of the dampers. The damping characteristics adapt to the current operating and driving situation.

The damping is tuned individually to each wheel and depends on:

- your driving style, e.g. sporty
- the road surface conditions
- the drive program selected

The drive program can be set using the DYNAMIC SELECT button (▷ page 120).

Selecting Comfort mode

In the **Comfort** drive program, the driving characteristics of your vehicle are more comfortable. Therefore, select this drive program if you prefer a more comfortable driving style. Also select the **Comfort** drive program when driving fast on straight roads, e.g. on straight stretches of highway.

- ▶ Press DYNAMIC SELECT button (▷ page 120) as many times as necessary until the **Comfort** drive program is selected.

Selecting Sport mode

The firmer setting of the suspension tuning in the **Sport** drive program ensures even better contact with the road. Select this drive program when employing a sporty driving style, e.g. on winding country roads.

- ▶ Press DYNAMIC SELECT button (▷ page 120) as many times as necessary until the **Sport** drive program is selected.

Parking Assist PARKTRONIC

Important safety notes

Parking Assist PARKTRONIC is an electronic parking aid with ultrasound. It monitors the area around your vehicle using six sensors in the front bumper and six sensors in the rear bumper. Parking Assist PARKTRONIC visually and audibly indicates the distance between your vehicle and an object.

Parking Assist PARKTRONIC is only an aid. It is not a replacement for your attention to your immediate surroundings. You are always responsible for safe maneuvering, parking and exiting a parking space. Make sure that there are no persons, animals or objects in the maneuvering area when you are maneuvering or parking.

! When parking, pay particular attention to objects above or below the sensors, such as flower pots or trailer drawbars. Parking Assist PARKTRONIC does not detect such objects when they are in the immediate vicinity of the vehicle. You could damage the vehicle or the objects.

The sensors may not detect snow and other objects that absorb ultrasonic waves.

Ultrasonic sources such as an automatic car wash, the compressed-air brakes of a truck or a pneumatic drill could cause Parking Assist PARKTRONIC to malfunction.

Parking Assist PARKTRONIC may not function correctly on uneven terrain.

Parking Assist PARKTRONIC is activated automatically when you:

- switch on the ignition
- shift the transmission to position **D**, **R** or **N**

Parking Assist PARKTRONIC is deactivated at speeds above 11 mph (18 km/h). It is reactivated at lower speeds.

Range of the sensors

General notes

Parking Assist PARKTRONIC does not take into account obstacles located:

- below the detection range, such as persons, animals or objects
- above the detection range, e.g. overhanging loads, tail sections or loading ramps of trucks

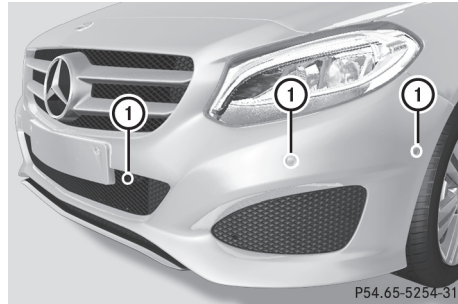

① Sensors in the front bumper, left-hand side (example)

The sensors must be free from dirt, ice or slush. They can otherwise not function correctly. Clean the sensors regularly, taking care not to scratch or damage them (> page 248).

Range



- ① Detection range of front sensors
- ② Detection range of rear sensors

Front sensors

| | |
|---------|--------------------------------|
| Center | Approx. 40 in (approx. 100 cm) |
| Corners | Approx. 24 in (approx. 60 cm) |

Rear sensors

| | |
|---------|--------------------------------|
| Center | Approx. 48 in (approx. 120 cm) |
| Corners | Approx. 32 in (approx. 80 cm) |

Minimum distance

| | |
|---------|------------------------------|
| Center | Approx. 8 in (approx. 20 cm) |
| Corners | Approx. 6 in (approx. 15 cm) |

If an obstacle is detected within this range, the relevant warning displays light up and a warning tone sounds. If the distance falls below the minimum, the distance may no longer be shown.

Warning displays

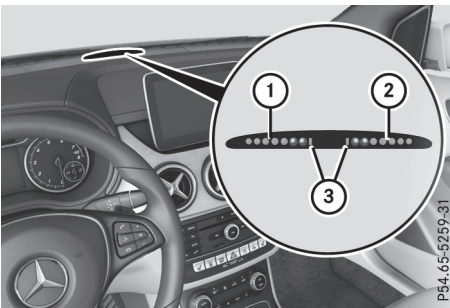

- ① Segments on the left-hand side of the vehicle
- ② Segments on the right-hand side of the vehicle
- ③ Segments showing operational readiness

The warning displays show the distance between the sensors and the obstacle. The warning display for the front area is located on the dashboard above the center air vents. The warning display for the rear area is located on the headliner in the rear compartment.

The warning display for each side of the vehicle is divided into five yellow and two red segments. Parking Assist PARKTRONIC is operational if yellow segments showing operational readiness ③ light up.

The gear lever position or the transmission position of the automatic transmission and the

direction in which the vehicle is rolling determine which warning display is active when the engine is running.

| Transmission position | Warning display |
|---|--------------------------------|
| D | Front area activated |
| R , N or the vehicle is rolling backwards | Rear and front areas activated |
| P | No areas activated |

One or more segments light up as the vehicle approaches an obstacle, depending on the vehicle's distance from the obstacle. In addition, warning tones are issued.

When the distance to the obstacle is sufficient, you will hear an intermittent warning tone. The shorter the distance to the obstacle, the shorter the frequency of the intermittent warning tones becomes. When the minimum distance is reached, you hear a continuous warning tone.

Deactivating or activating Parking Assist PARKTRONIC



- ① Indicator lamp
- ② Deactivates or activates Parking Assist PARKTRONIC

If indicator lamp ① is lit, Parking Assist PARKTRONIC is deactivated.

- ❗ Parking Assist PARKTRONIC is automatically activated when you turn the SmartKey to position ② in the ignition lock.

Problems with Parking Assist PARKTRONIC

| Problem | Possible causes/consequences and ► Solutions |
|--|---|
| Only the red segments in the Parking Assist PARKTRONIC warning displays are lit. You also hear a warning tone for approximately two seconds. Parking Assist PARKTRONIC is then deactivated and the indicator lamp on the PARKTRONIC button lights up. | Parking Assist PARKTRONIC has malfunctioned and has been deactivated. ► If problems persist, have Parking Assist PARKTRONIC checked at a qualified specialist workshop. |
| Only the red segments in the Parking Assist PARKTRONIC warning displays are lit. Parking Assist PARKTRONIC is then deactivated. | The Parking Assist PARKTRONIC sensors are dirty or there is interference. ► Clean the Parking Assist PARKTRONIC sensors (▷ page 248). ► Switch the ignition back on. The problem may be caused by an external source of radio or ultrasound waves. ► Check to see if Parking Assist PARKTRONIC works at a different location. |

Parking Pilot

General notes

Parking Pilot is an electronic parking aid with ultrasound. It measures the road on both sides of the vehicle. A parking symbol indicates a suitable parking space. Active steering intervention and brake application can assist you during parking and when exiting a parking space. Parking Assist PARKTRONIC is also available (▷ page 148).

Important safety notes

Parking Pilot is only an aid. It is not a replacement for your attention to your immediate surroundings. You are always responsible for safe maneuvering, parking and exiting a parking space. Make sure that there are no persons, animals or objects in the maneuvering area when you are maneuvering or parking.

When Parking Assist PARKTRONIC is deactivated, Parking Pilot is also unavailable.

WARNING

While parking or pulling out of a parking space, the vehicle swings out and can drive onto areas of the oncoming lane. This could result in a collision with another road user. There is a risk of an accident.

Pay attention to other road users. Stop the vehicle if necessary or cancel the Parking Pilot parking procedure.

! If they cannot be avoided, drive over obstacles such as curbs slowly and at an obtuse angle. Otherwise, you may damage the wheels or tires.

Parking Pilot may also display spaces not suitable for parking, e.g.:

- Where parking or stopping is prohibited
- In front of driveways or entrances and exits
- On unsuitable surfaces

Parking tips:

- On narrow roads, drive as close to the parking space as possible.
- Parking spaces that are littered or overgrown might be identified or measured incorrectly.
- Parking spaces that are partially occupied by trailer drawbars might not be identified as such or be measured incorrectly.
- Snowfall or heavy rain may lead to a parking space being measured inaccurately.
- Pay attention to the warning messages of Parking Assist PARKTRONIC during the parking procedure (▷ page 150).
- You can intervene to correct the steering procedure at any time. Parking Pilot will then be canceled.
- When transporting a load that protrudes from your vehicle, you must not use Parking Pilot.
- Never use Parking Pilot when snow chains are mounted.
- Make sure that the tire pressures are always correct. This has a direct influence on the parking characteristics of the vehicle.

Use Parking Pilot for parking spaces that are:

- that are parallel or at right-angles to the direction of travel
- on straight roads, not bends
- on the same level as the road, e.g. not on the pavement

Detecting parking spaces

Objects located above the detection range of Parking Pilot will not be detected when the parking space is measured. These are not taken into account when the parking procedure is calculated, e.g. overhanging loads, truck overhangs or loading ramps. Parking Pilot may therefore guide you into the parking space too early.

Parking Pilot does not assist you parking in spaces perpendicular to the direction of travel if:

- two parking spaces are located directly next to one another
- the parking space is directly next to a low obstacle such as a low curb
- you forward-park

Parking Pilot does not assist you parking in spaces parallel or perpendicular to the direction of travel if:

- the parking space is on a curb
- the system reads the parking space as being blocked, for example by foliage or grass paving blocks
- the area is too small for the vehicle to maneuver into
- the parking space is bordered by an obstacle, e.g. a tree, a post or a trailer

For further information on the detection range (▷ page 149).

⚠ WARNING

If there are objects above the detection range:

- Parking Pilot may steer in too early
- the vehicle may not stop in front of these objects

You may cause a collision as a result. There is a risk of an accident.

If objects are located above the detection range, stop and deactivate Parking Pilot.

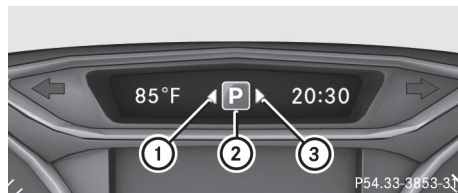

- ① Detected parking space on the left
- ② Parking symbol
- ③ Detected parking space on the right

Parking Pilot is activated automatically when driving forward. The system is operational at speeds of up to approximately 22 mph (35 km/h). While in operation, the system independently locates and measures parking spaces on both sides of the vehicle.

Parking Pilot will only detect parking spaces:

- that are parallel or at right-angles to the direction of travel
- that are parallel to the direction of travel and at least 59 in (1.5 m) wide

- that are parallel to the direction of travel and at least 39.5 in (1.0 m) longer than your vehicle
- at right angles to the direction of travel and at least 39.5 in (1.0 m) wider than your vehicle

When driving at speeds below 19 mph (30 km/h), you will see parking symbol ② as a status indicator in the instrument cluster. When a parking space has been detected, an arrow towards the right or the left also appears. Parking Pilot only displays parking spaces on the front-passenger side as standard. Parking spaces on the driver's side are displayed as soon as the turn signal on the driver's side is activated. When parking on the driver's side, this must remain activated until you confirm the use of Parking Pilot by pressing the **[OK]** button on the multifunction steering wheel. The system automatically determines whether the parking space is parallel or at right-angles to the direction of travel.

A parking space is displayed while you are driving past it, and until you are approximately 50 ft (15 m) away from it.

Parking

WARNING

If you leave the vehicle when it is only being braked by Parking Pilot, it could roll away if:

- there is a malfunction in the system or in the voltage supply.
- the electrical system in the engine compartment, the battery or the fuses are tampered with.
- the battery is disconnected.
- the vehicle is accelerated, e.g. by a vehicle occupant.

There is a risk of an accident.

Before leaving the vehicle, always secure it against rolling away.

- i** If Parking Assist PARKTRONIC detects obstacles, Parking Pilot brakes automatically whilst the vehicle is being parked. You are responsible for braking in good time.

► Stop the vehicle when the parking space symbol shows the desired parking space in the instrument cluster.

► Shift the transmission to position **[R]**. The **Start Parking Pilot? Yes: OK No: ** message appears in the multifunction display.

► **To cancel the procedure:** press the **** button on the multifunction steering wheel or pull away.

or

► **To park using Parking Pilot:** press the **[OK]** button on the multifunction steering wheel. The **Parking Pilot Active Accelerate and Brake Observe Surroundings** message appears in the multifunction display.

► Let go of the multifunction steering wheel.

► Back up the vehicle, being ready to brake at all times. When backing up, drive at a speed below approximately 6 mph (10 km/h). Otherwise, Parking Pilot is canceled immediately. Parking Pilot brakes the vehicle to a standstill when the vehicle approaches the rear border of the parking space.

Maneuvering may be required in tight parking spaces.

The **Parking Pilot Active Select D Observe Surroundings** message appears in the multifunction display.

► Shift the transmission to position **[D]** while the vehicle is stationary. Parking Pilot immediately steers in the other direction.

The **Parking Pilot Active Accelerate and Brake Observe Surroundings** message appears in the multifunction display.

i You will achieve the best results by waiting for the steering procedure to complete before pulling away.

► Drive forwards and be ready to brake at all times.

Parking Pilot brakes the vehicle to a standstill when the vehicle approaches the front border of the parking space.

Maneuvering may be required in tight parking spaces.

The **Parking Pilot Active Select R Observe Surroundings** message appears in the multifunction display.

As soon as the parking procedure is complete, the **Parking Pilot Finished** message

appears and a warning tone sounds. The vehicle is now parked.

The vehicle is kept stationary without the driver having to depress the brake pedal. The braking effect is canceled when you depress the accelerator pedal.

Parking Pilot no longer supports you with steering interventions and brake applications. When Parking Pilot is finished, you must steer and brake again yourself. Parking Assist PARKTRONIC is still available.

Parking tips:

- The way your vehicle is positioned in the parking space after parking is dependent on various factors. These include the position and shape of the vehicles parked in front and behind it and the conditions of the location. It may be the case that Parking Pilot guides you too far into a parking space, or not far enough into it. In some cases, it may also lead you across or onto the curb. If necessary, you should cancel the parking procedure with Parking Pilot.
- You can also preselect transmission position **D**. The vehicle redirects and does not drive as far into the parking space. Should the transmission change take place too early, the parking procedure is canceled. A sensible parking position can no longer be achieved from this position.

Exiting a parking space



In order for Parking Pilot to support you when exiting the parking space:

- you need to have parked using Parking Pilot.
- the border of the parking space must be high enough at the front and the rear. A curb stone is too small, for example.
- the border of the parking space must not be too wide, as the position of the vehicle must not exceed an angle of 45° to the starting position as it is maneuvered into the parking space.
- a maneuvering distance of at least 3.3 ft (1.0 m) must be available.

Parking Pilot can assist you with exiting a parking space only if you have parked the vehicle parallel to the direction of travel using Parking Pilot.

- ❗ If Parking Assist PARKTRONIC detects obstacles, Parking Pilot brakes automatically

while the vehicle is exiting the parking space. You are responsible for braking in good time.

- ▶ Start the engine.
- ▶ Release the electric parking brake.
- ▶ Switch on the turn signal in the direction you will drive out of the parking space.
- ▶ Shift the transmission to position **D** or **R**. The **Start Parking Pilot? Yes: OK No:**  message appears in the multifunction display.
- ▶ **To cancel the procedure:** press the  button on the multifunction steering wheel or pull away.

or

- ▶ **To exit a parking space using Parking Pilot:** press the **OK** button on the multifunction steering wheel. The **Parking Pilot Active Accelerate and Brake Observe Surroundings** message appears in the multifunction display.
- ▶ Let go of the multifunction steering wheel.
- ▶ Pull away, being ready to brake at all times. Do not exceed a maximum speed of approximately 6 mph (10 km/h) when exiting a parking space. Otherwise, Parking Pilot is canceled immediately.
- ▶ Depending on the message or as required, shift the transmission to position **D** or **R**. Parking Pilot immediately steers in the other direction. The **Parking Pilot Active Accelerate and Brake Observe Surroundings** message appears in the multifunction display.

- ❗ You will achieve the best results by waiting for the steering procedure to complete before pulling away.

If you back up after activation, the steering wheel is moved to the straight-ahead position.

- ▶ Drive forwards and reverse as prompted by the Parking Assist PARKTRONIC warning displays, several times if necessary.

Once you have exited the parking space completely, the steering wheel is moved to the straight-ahead position. You hear a tone and the **Parking Pilot Finished** message appears in the multifunction display. You will then have to steer and merge into traffic on your own. Parking Assist PARKTRONIC is still available. You can take over the steering before the vehicle has exited the parking space completely. This is

useful, for example when you recognize that it is already possible to pull out of the parking space.

Canceling Parking Pilot

- ▶ Stop the movement of the multifunction steering wheel or steer yourself. Parking Pilot is canceled immediately. The **Parking Pilot Canceled** message appears in the multifunction display.

or

- ▶ Press the PARKTRONIC button (▷ page 150). Parking Assist PARKTRONIC is switched off and Parking Pilot is immediately canceled. The **Parking Pilot Canceled** message appears in the multifunction display.

Parking Pilot is canceled automatically when:

- the electric parking brake is engaged
- transmission position **P** is selected
- parking using Parking Pilot is no longer possible
- you are driving faster than 6 mph (10 km/h)
- a wheel spins, ESP® intervenes or fails. In such cases the  warning lamp lights up in the instrument cluster

A warning tone sounds. The parking symbol disappears and the multifunction display shows the **Parking Pilot Canceled** message.

When Parking Pilot is canceled, you must steer and brake again yourself.

If a system malfunction occurs, the vehicle is braked to a standstill. To drive on, depress the accelerator again.

Rear view camera

General notes

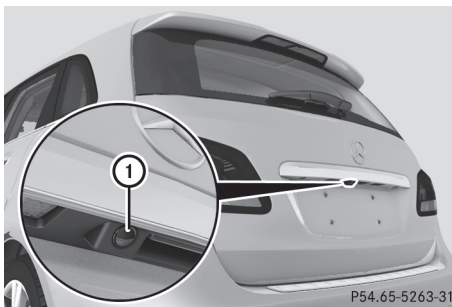

Rear view camera ① is an optical parking and maneuvering aid. It shows the area behind your vehicle with guide lines in the multimedia system display.

The area behind the vehicle is displayed as a mirror image, as in the rear view mirror.

Observe the notes on cleaning (▷ page 248).

- i** The text shown in the multimedia system display depends on the language setting. The following are examples of rear view camera messages in the multimedia system display.

Important safety notes

The rear view camera is only an aid. It is not a replacement for your attention to your immediate surroundings. You are always responsible for safe maneuvering and parking. Make sure that there are no persons, animals or objects in the maneuvering area when you are maneuvering or parking.

Under the following circumstances, the rear view camera will not function, or will function in a limited manner:

- if the tailgate is open
- in heavy rain, snow or fog
- at night or in very dark places
- if the camera is exposed to very bright light
- if the area is lit by fluorescent bulbs or LED lighting (the display may flicker)
- if there is a sudden change in temperature, e.g. when driving into a heated garage in winter
- if the camera lens is dirty or obstructed. Observe the notes on cleaning (▷ page 248)
- if the rear of your vehicle is damaged. In this case, have the camera position and setting checked at a qualified specialist workshop

The field of vision and other functions of the rear view camera may be restricted due to additional accessories on the rear of the vehicle (e.g. license plate holder, rear bicycle rack).

- i** The contrast of the display may be affected by the sudden presence of sunlight or other light sources, e.g. when exiting a garage. Pay particular attention in this situation.

- i** If usability is severely restricted, e.g. due to pixel errors, have the display repaired or replaced.

Activating/deactivating the rear view camera

- ▶ **To activate:** make sure that the SmartKey is in position **2** in the ignition lock.
- ▶ Make sure that the **Activation by R gear** function is selected in the multimedia system; see the Digital Operator's Manual.
- ▶ Engage reverse gear.
The area behind the vehicle is shown with guide lines in the multimedia system display.
The image from the rear view camera is available throughout the maneuvering process.

To deactivate: the rear view camera deactivates if you shift the transmission to **P** or after driving forwards a short distance.

If the complete system fails, the inner segments of the warning display are shown in red. The indicator lamp on the PARKTRONIC button lights up.

If the rear system fails:

- the rear segments are shown in red when reversing
- the rear segments are hidden when driving forward

Messages in the multimedia system display

The rear view camera may show a distorted view of obstacles, show them incorrectly or not at all. The rear view camera does not show objects in the following positions:

- very close to the rear bumper
 - under the rear bumper
 - in the area immediately above the tailgate handle
- !** Objects not at ground level may appear to be further away than they actually are, e.g.:
- the bumper of a parked vehicle
 - the drawbar of a trailer
 - the ball coupling of a trailer tow hitch
 - the rear section of an HGV
 - a slanted post

Use the guidelines only for orientation. Approach objects no further than the bottom-most guideline.

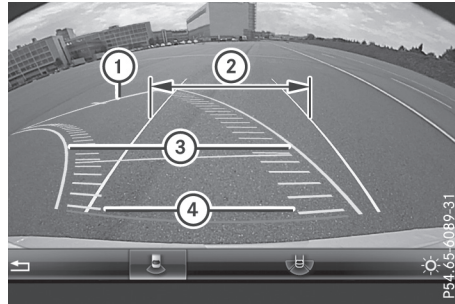

- ① Yellow guide line at a distance of approximately 13 ft (4.0 m) from the rear of the vehicle
- ② White guide line without steering input – vehicle width including the exterior mirrors (static)
- ③ Yellow guide line for the vehicle width including the exterior mirrors, at the current steering wheel angle (dynamic)
- ④ Yellow lane marking the course the tires will take at the current steering wheel angle (dynamic)

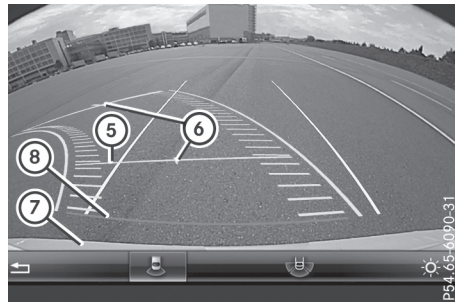

- ⑤ Yellow guide line at a distance of approximately 3 ft (1.0 m) from the rear of the vehicle
- ⑥ Vehicle center axle (marker assistance)
- ⑦ Bumper
- ⑧ Red guide line at a distance of approximately 12 in (0.30 m) from the rear of the vehicle



P54.65-5272-31

- ① Front warning display
- ② Additional measurement operational readiness indicator for Parking Assist PARKTRONIC
- ③ Rear warning display

When Parking Assist PARKTRONIC is operational (> page 150), additional measurement operational readiness indicator ② appears in the multimedia system display. If the Parking Assist PARKTRONIC warning displays are active or light up, warning displays ① and ③ are also active or light up correspondingly in the multimedia system display.

"Reverse parking" function

Backing up straight into a parking space without steering input

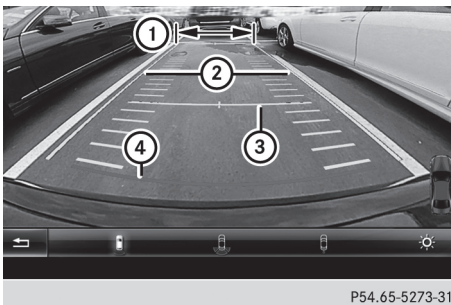

P54.65-5273-31

- ① White guide line without steering input – vehicle width including the exterior mirrors (static)
- ② Yellow guide line for the vehicle width including the exterior mirrors, at the current steering wheel angle (dynamic)

- ③ Yellow guide line at a distance of approximately 3 ft (1.0 m) from the rear of the vehicle

- ④ Red guide line at a distance of approximately 12 in (0.30 m) from the rear of the vehicle

- ▶ Make sure that the rear view camera is switched on (> page 156). The lane and the guide lines are shown.
- ▶ With the help of white guide line ①, check whether the vehicle will fit into the parking space.
- ▶ Using white guide line ① as a guide, carefully back up until you reach the end position. Red guide line ④ is then at the end of the parking space. The vehicle is almost parallel in the parking space.

Reverse perpendicular parking with steering input

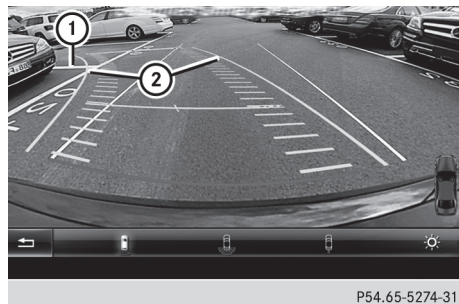

P54.65-5274-31

- ① Parking space marking
- ② Yellow guide line for the vehicle width including the exterior mirrors, at the current steering wheel angle (dynamic)

- ▶ Drive past the parking space and bring the vehicle to a standstill.
- ▶ Make sure that the rear view camera is switched on (> page 156). The lane and the guide lines are shown.
- ▶ While the vehicle is at a standstill, turn the steering wheel in the direction of the parking space until yellow guide line ② reaches parking space marking ①.
- ▶ Maintain the steering input and reverse carefully.

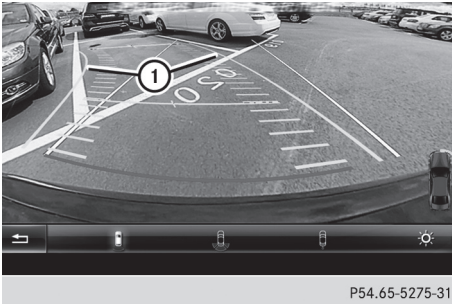

P54.65-5275-31

- ① Yellow guide line for the vehicle width including the exterior mirrors, at the current steering wheel angle (dynamic)

- Stop the vehicle when it is almost exactly in front of the parking space. The white lane should be as close to parallel with the parking space marking as possible.

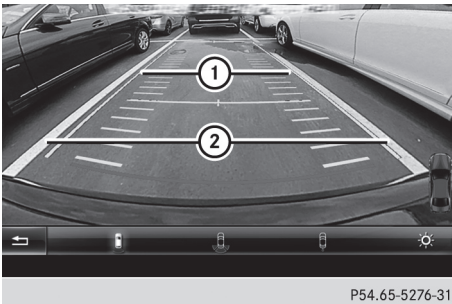

P54.65-5276-31

- ① White guide line at the current steering input
② Parking space marking

- Turn the steering wheel to the center position while the vehicle is stationary.

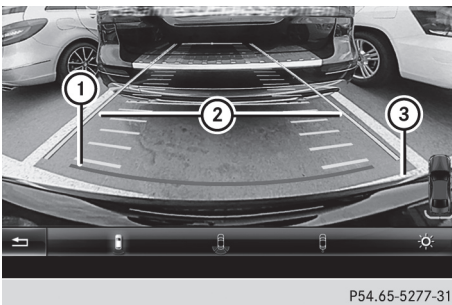

P54.65-5277-31

- ① Red guide line at a distance of approximately 12 in (0.30 m) from the rear of the vehicle
② White guide line without steering input
③ End of parking space

- Back up carefully until you have reached the final position. Red guide line ① is then at end of parking space ③. The vehicle is almost parallel in the parking space.

Wide-angle function

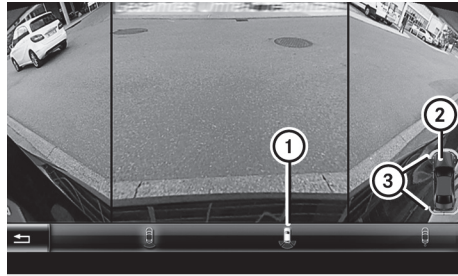

P54.65-4902-31

- ① Symbol for the wide-angle view function
② Your vehicle
③ Parking Assist PARKTRONIC warning displays

Select this view when you are driving out of an exit and the view of crossing traffic is restricted, for example.

ATTENTION ASSIST

General notes

ATTENTION ASSIST helps you during long, monotonous journeys, such as on highways. It is active in the 37 mph (60 km/h) to 125 mph (200 km/h) range. If ATTENTION ASSIST detects typical indicators of fatigue or increasing lapses in concentration on the part of the driver, it suggests taking a break.

Important safety notes

ATTENTION ASSIST is only an aid to the driver. It might not always recognize fatigue or increasing inattentiveness in time or fail to recognize them at all. The system is not a substitute for a well-rested and attentive driver.

The functionality of ATTENTION ASSIST is restricted and warnings may be delayed or not occur at all:

- if the length of the journey is less than approximately 30 minutes
- if the road condition is poor, e.g. if the surface is uneven or if there are potholes
- if there is a strong side wind
- if you have adopted a sporty driving style with high cornering speeds or high rates of acceleration
- if you are predominantly driving slower than 37 mph (60 km/h) or faster than 125 mph (200 km/h)
- if the time has been set incorrectly
- in active driving situations, such as when you change lanes or change your speed

ATTENTION ASSIST is reset when you continue your journey and starts assessing your tiredness again if:

- you switch off the engine
- you take off your seat belt and open the driver's door, e.g. for a change of drivers or to take a break

Displaying the attention level with black and white multifunction display



- ▶ Select the status overview using the on-board computer (> page 173).
- ▶ Press  to display the ATTENTION ASSIST assessment.

The following information is displayed:

- The length of the journey since the last break.
- The **Attention Level** determined by ATTENTION ASSIST, displayed in a bar display in five levels from high to low.
- If ATTENTION ASSIST is unable to calculate the attention level and cannot output a warn-

ing, the **System Suspended** message appears. The bar display then changes the display, such as when you are driving at a speed below 37 mph (60 km/h) or above 125 mph (200 km/h).

Displaying Attention Level with color multifunction display



You can have current status information displayed in the assistance menu (> page 172) of the on-board computer.

- ▶ Select the Assistance display for Attention Assist using the on-board computer (> page 173).

The following information is displayed:

- The length of the journey since the last break.
- The **Attention Level** determined by ATTENTION ASSIST, displayed in a bar display in five levels from high to low.
- If ATTENTION ASSIST is unable to calculate the attention level and cannot output a warning, the **System Suspended** message appears. The bar display then changes the display, such as when you are driving at a speed below 37 mph (60 km/h) or above 125 mph (200 km/h).

Activating ATTENTION ASSIST

- ▶ Activate ATTENTION ASSIST using the on-board computer (> page 174). The system determines the attention level of the driver depending on the setting selected:

Standard selected: the sensitivity with which the system determines the attention level is set to normal.

Sensitive selected: the sensitivity is set higher. The attention level detected by Attention

Assist is adapted accordingly and the driver is warned earlier.

Vehicles with black and white multifunction display: when ATTENTION ASSIST is activated, the multifunction display in the status overview shows the  symbol.

Vehicles with color multifunction display: when ATTENTION ASSIST is deactivated, the multifunction display in the assistance graphic shows the  symbol.

When ATTENTION ASSIST has been deactivated, it is automatically reactivated after the engine has been stopped. The sensitivity selected corresponds to the last selection activated (standard/sensitive).

Warning in the multifunction display

If fatigue or increasing lapses in concentration are detected, a warning appears in the multifunction display: **ATTENTION ASSIST Take a Break!**

In addition to the message shown in the multifunction display, you will then hear a warning tone.

- ▶ If necessary, take a break.
- ▶ Confirm the message by pressing the  button on the steering wheel.

On long journeys, take regular breaks in good time to allow yourself to rest properly. If you do not take a break and ATTENTION ASSIST still detects increasing lapses in concentration, you will be warned again after 15 minutes at the earliest. This will only happen if ATTENTION ASSIST still detects typical indicators of fatigue or increasing lapses in concentration.

Vehicles with the COMAND multimedia system: if a warning is output in the multifunction display, a service station search is performed in the multimedia system. You can select a service station and navigation to this service station will then begin. This function can be activated or deactivated in the multimedia system; see the Digital Operator's Manual.

Lane Tracking package

General notes

The Lane Tracking package consists of Blind Spot Assist (> page 160) and Lane Keeping Assist (> page 162).

Blind Spot Assist

General notes

Blind Spot Assist monitors the areas on either side of the vehicle that are not visible to the driver with two lateral, rear-facing radar sensors. A warning display in the exterior mirrors draws your attention to vehicles detected in the monitored area. If you then switch on the corresponding turn signal to change lane, you will also receive an optical and audible warning.

Blind Spot Assist supports you from a speed of approximately 20 mph (30 km/h).

Important safety notes

WARNING

Blind Spot Assist does not react to:

- vehicles overtaken too closely on the side, placing them in the blind spot area
- vehicles which approach with a large speed differential and overtake your vehicle

As a result, Blind Spot Assist may not give warnings in such situations. There is a risk of an accident.

Always observe the traffic conditions carefully, and maintain a safe lateral distance.

Blind Spot Assist is only an aid. It may fail to detect some vehicles and is no substitute for attentive driving. Always ensure that there is sufficient distance to the side for other road users and obstacles.

USA only:

This device has been approved by the FCC as a "Vehicular Radar System". The radar sensor is intended for use in an automotive radar system only. Removing, tampering with, or altering the device will void any warranties, and is not permitted by the FCC. Do not tamper with, alter, or use in any non-approved way.

Any unauthorized modification to this device could void the user's authority to operate the equipment.

Radar sensors

The radar sensors for Blind Spot Assist are integrated into the rear bumper. Make sure that the bumpers are free from dirt, ice or slush. The sensors must not be covered, for example by

cycle racks or overhanging loads. Following a severe impact or in the event of damage to the bumpers, have the function of the radar sensors checked at a qualified specialist workshop. Blind Spot Assist may no longer work properly.

Monitoring range of the sensors

In particular, the detection of obstacles can be impaired if:

- there is dirt on the sensors or anything else covering the sensors
- there is poor visibility, e.g. due to fog, heavy rain or snow
- a narrow vehicle traveling in front, e.g. a motorbike or bicycle
- the road has very wide lanes
- the road has narrow lanes
- you are not driving in the middle of the lane
- there are barriers or other road boundaries

Vehicles in the monitoring range are then not indicated.

Blind Spot Assist monitors the area up to 10 ft (3 m) behind your vehicle and directly next to it.

If the lanes are narrow, vehicles driving in the lane beyond the lane next to your vehicle may be indicated, especially if the vehicles are not driving in the middle of their lane. This may be the case if the vehicles are driving on the inner side of their lane.

Due to the nature of the system:

- warnings may be issued in error when driving close to crash barriers or similar solid lane borders.
- warnings may be interrupted when you are driving alongside particularly long vehicles, such as trucks, for a prolonged time.

Warning display

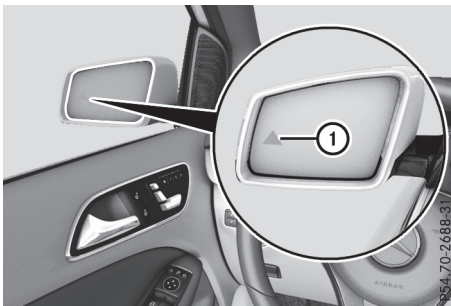

① Warning display

Blind Spot Assist is not active at speeds below approximately 20 mph (30 km/h). Vehicles in the monitoring range are then not indicated.

When Blind Spot Assist is activated, indicator lamp ① in the exterior mirrors lights up yellow at speeds of up to 20 mph (30 km/h). At speeds above 20 mph (30 km/h), the indicator lamp goes out and Blind Spot Assist is operational.

If a vehicle is detected within the blind spot monitoring range at speeds above 20 mph (30 km/h), warning lamp ① on the corresponding side lights up red. This warning is always emitted when a vehicle enters the blind spot monitoring range from behind or from the side. When you overtake a vehicle, the warning only occurs if the difference in speed is less than 7 mph (12 km/h).

The yellow indicator lamp goes out if reverse gear is engaged. In this event, Blind Spot Assist is no longer active.

The brightness of the indicator/warning lamps is adjusted automatically according to the ambient light.

Collision warning

If a vehicle is detected in the monitoring range of Blind Spot Assist and you switch on the corresponding turn signal, a double warning tone sounds. Red warning lamp ① flashes. If the turn signal remains on, vehicles detected are indicated by the flashing of red warning lamp ①. There are no further warning tones.

Switching on Blind Spot Assist

- ▶ Make sure that Blind Spot Assist is activated in the on-board computer (> page 174).
- ▶ Turn the SmartKey to position ② in the ignition lock.

Warning lamps ① in the exterior mirrors light up red for approximately 1.5 seconds and then turn yellow.

Lane Keeping Assist

General notes

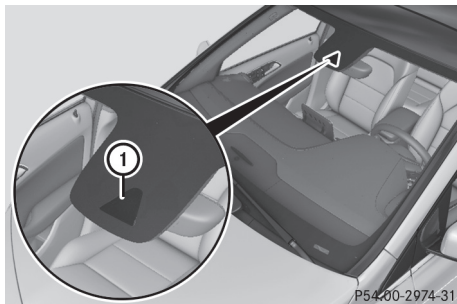

Lane Keeping Assist monitors the area in front of your vehicle by means of multifunction camera ① which is attached behind the top of the windshield. Lane Keeping Assist detects lane markings on the road and can warn you before you leave your lane unintentionally.

This function is available in the range between 40 mph and 120 mph (60 km/h and 200 km/h). A warning may be given if a front wheel passes over a lane marking. It will warn you by means of intermittent vibration in the steering wheel for up to 1.5 seconds.

Important safety notes

WARNING

Lane Keeping Assist cannot always clearly detect lane markings.

In such cases, Lane Keeping Assist can:

- give an unnecessary warning
- not give a warning

There is a risk of an accident.

Always pay particular attention to the traffic situation and keep within the lane, especially if Lane Keeping Assist alerts you.

WARNING

The Lane Keeping Assist warning does not return the vehicle to the original lane. There is a risk of an accident.

You should always steer, brake or accelerate yourself, in particular if warned by Lane Keeping Assist.

If you fail to adapt your driving style, Lane Keeping Assist can neither reduce the risk of an accident nor override the laws of physics. Lane Keeping Assist cannot take into account the road, traffic and weather conditions. Lane Keeping Assist is merely an aid. You are responsible for the distance to the vehicle in front, for vehicle speed, for braking in good time and for staying in your lane.

The Lane Keeping Assist does not keep the vehicle in the lane.

The system may be impaired or may not function if:

- there is poor visibility, e.g. due to insufficient illumination of the road, or due to snow, rain, fog or spray
- there is glare, e.g. from oncoming traffic, the sun or reflection from other vehicles (e.g. if the road surface is wet)
- the windshield is dirty, fogged up, damaged or covered, for instance by a sticker, in the vicinity of the camera
- there are no or several unclear lane markings for one lane, e.g. roadworks
- the lane markings are worn away, dark or covered up, e.g. by dirt or snow
- the distance to the vehicle in front is too short and thus the lane markings cannot be detected
- the lane markings change quickly, e.g. lanes branch off, cross one another or merge
- the road is narrow and winding
- there are highly variable shade conditions on the roadway

Switching on Lane Keeping Assist

- Switch on Active Lane Keeping Assist using the on-board computer; to do so, select **Standard** or **Adaptive** (▷ page 162). If you drive at speeds above 40 mph (60 km/h) and lane markings are detected, the lines in the assistance graphic are shown in green (▷ page 173). Lane Keeping Assist is ready for use.

If **Standard** is selected, no warning vibration occurs if:

- you have switched on the turn signal. In this event, the warnings are suppressed for a certain period of time.
- a driving safety system intervenes, e.g. ABS, BAS or ESP®.

When **Adaptive** is selected, no warning vibration occurs if:

- you have switched on the turn signal. In this event, the warnings are suppressed for a certain period of time.
- a driving safety system intervenes, e.g. ABS, BAS or ESP®.
- you accelerate hard, e.g. kickdown.
- you brake hard.
- you steer actively, e.g. swerve to avoid an obstacle or change lanes quickly.
- you cut the corner on a sharp bend.

In order that you are warned only when necessary and in good time if you cross the lane marking, the system detects certain conditions and warns you accordingly.

The warning vibration occurs earlier if:

- you approach the outer lane marking on a bend
- the road has very wide lanes, e.g. a freeway
- the system detects solid lane markings

The warning vibration occurs later if:

- the road has narrow lanes.
- you cut the corner on a bend

Important safety notes

WARNING

If you operate information systems and communication equipment integrated in the vehicle when driving, you may be distracted from the traffic situation. You could also lose control of the vehicle. There is a risk of an accident.

Only operate this equipment when the traffic situation permits. If you are not sure that this is possible, park the vehicle paying attention to traffic conditions and operate the equipment when the vehicle is stationary.

You must observe the legal requirements for the country in which you are currently driving when operating the on-board computer.

WARNING

If the instrument cluster has failed or malfunctioned, you may not recognize function restrictions in systems relevant to safety. The operating safety of your vehicle may be impaired. There is a risk of an accident.

Drive on carefully. Have the vehicle checked at a qualified specialist workshop immediately.

The on-board computer only shows messages or warnings from certain systems in the multifunction display. You should therefore make sure your vehicle is operating safely at all times.

If the operating safety of your vehicle is impaired, pull over as soon as it is safe to do so. Contact a qualified specialist workshop.



For an overview, see the instrument panel illustration (> page 31).

Displays and operation

Instrument cluster lighting

The light sensor in the instrument cluster automatically controls the brightness of the multifunction display. In daylight, the displays in the instrument cluster are not illuminated.

The lighting in the instrument cluster, in the displays and the controls in the vehicle interior can be adjusted using the brightness control knob. The brightness control knob is located on the bottom left of the instrument cluster (> page 31).

- ▶ Turn the brightness control knob clockwise or counter-clockwise.
If the light switch is set to the ,  or  position, the brightness is dependent upon the brightness of the ambient light.

Speedometer with segments

The speedometer is divided into segments on vehicles with Distance Pilot DISTRONIC.

The segments in the speedometer indicate which speed range is available.

- Distance Pilot DISTRONIC is activated (> page 140):
One or two segments in the set speed range light up.
- Distance Pilot DISTRONIC detects a vehicle in front moving more slowly than the stored speed:
The segments between the speed of the vehicle in front and the stored speed light up.

Tachometer

-  Do not drive in the overrevving range, as this could damage the engine.

The red band in the tachometer indicates the engine's overrevving range.

The engine is limited within a range to protect the engine when the red band is reached.

Outside temperature display

You should pay special attention to road conditions when temperatures are around freezing point.

Bear in mind that the outside temperature display indicates the temperature measured and does not record the road temperature.

The outside temperature display is in the multifunction display (> page 167).

There is a short delay before a change in outside temperature appears in the multifunction display.

Coolant temperature gauge

WARNING

Opening the hood when the engine is overheated or when there is a fire in the engine compartment could expose you to hot gases or other service products. There is a risk of injury.

Let an overheated engine cool down before opening the hood. If there is a fire in the engine compartment, keep the hood closed and contact the fire department.

! A display message is shown if the coolant temperature is too high.

If the coolant temperature is over 248 °F (120 °C), do not continue driving. The engine will otherwise be damaged.

The coolant temperature gage is in the instrument cluster on the right-hand side (▷ page 31). The **H** marking in the coolant temperature gauge corresponds to a coolant temperature of approximately 248 °F (120 °C).

Under normal operating conditions and at the correct coolant level, the coolant temperature gauge may rise to the **H** marking.

Operating the on-board computer

Overview

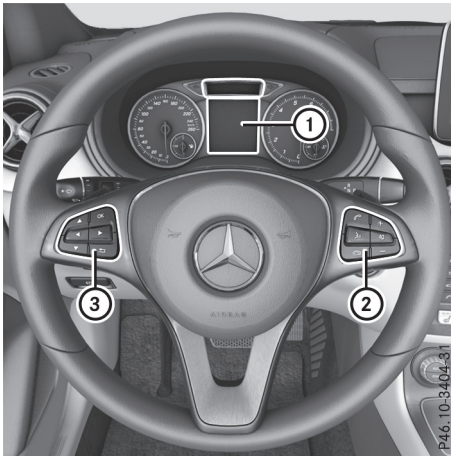









- ① Multifunction display
- ② Right control panel
- ③ Left control panel





► **To activate the on-board computer:** turn the SmartKey to position **1** in the ignition lock.



You can control the multifunction display and the settings in the on-board computer using the buttons on the multifunction steering wheel.

Left control panel

| | |
|---|--|
|  | <ul style="list-style-type: none"> • Calls up the menu and menu bar |
|  | |
|  | <p>Press briefly:</p> <ul style="list-style-type: none"> • Scrolls in lists • Selects a submenu or function • In the Audio menu: selects the previous or next station, when the preset list or station list is active, or an audio track or video scene • In the Te1 (telephone) menu: switches to the phone book and selects a name or telephone number |
|  | |
|  | <p>Press and hold:</p> <ul style="list-style-type: none"> • In the Audio menu: selects a preset list or a station list in the desired frequency range, or an audio track or video scene using rapid scrolling • In the Te1 (Telephone) menu: starts rapid scrolling if the phone book is open |
|  | |
|  | <ul style="list-style-type: none"> • Confirms the selection or display message • In the Te1 (Telephone) menu: switches to the telephone book and starts dialing the selected number |
|  | <p>Press briefly:</p> <ul style="list-style-type: none"> • Back • Vehicles with Audio 20: switches off voice-operated control for navigation (see the manufacturer's operating instructions) • Vehicles with COMAND: switches off the Voice Control System (see the separate operating instructions) • Hides display messages or calls up the last Trip menu function used • Exits the phone book/redial memory |
|  | <p>Press and hold:</p> <ul style="list-style-type: none"> • Calls up the standard display in the Trip menu |

Right control panel

| | |
|---|--|
|  | <ul style="list-style-type: none"> • Vehicles with Audio 20: Switches on voice-operated control for navigation (see the manufacturer's operating instructions) • Vehicles with COMAND: Switches off the Voice Control System (see the separate operating instructions) |
|  | <ul style="list-style-type: none"> • Mute |
|   | <ul style="list-style-type: none"> • Adjusts the volume |

| | |
|---|--|
|  | <ul style="list-style-type: none"> • Rejects or ends a call • Exits the phone book/redial memory |
|  | <ul style="list-style-type: none"> • Makes or accepts a call • Switches to the redial memory |

Multifunction display

Black and white multifunction display

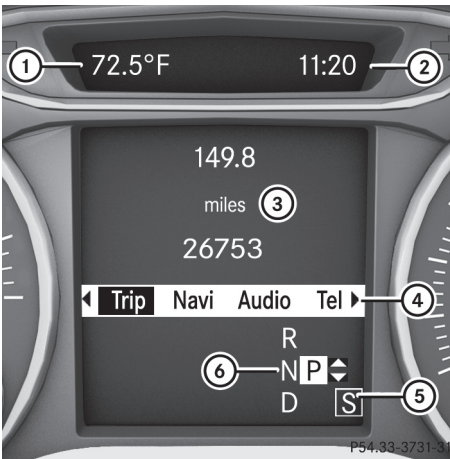

- ④ Menu bar
- ⑤ Drive program (▷ page 121)
- ⑥ Transmission position (▷ page 123)

Overview

▶ **To display menu bar** ④: press the ◀ or ▶ button on the steering wheel. If you do not press the buttons any longer, menu bar ④ is faded out after a few seconds. Text field ③ shows the selected menu or submenu as well as display messages.

The following menu illustrations differ in vehicles with black and white and color multifunction display. The examples given in this Operator's Manual apply to vehicles equipped with color multifunction display.

i You can set the time using Audio 20 or COMAND (see Digital Operator's Manual).

Color multifunction display

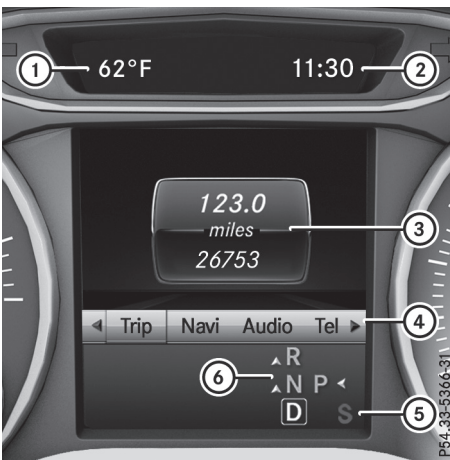

Further displays

The following messages may appear in the multifunction display:

- ↑ Gearshift recommendation when shifting manually (▷ page 125)
- P** Parking Pilot (▷ page 151)
- CRUISE** Cruise control (▷ page 138)
- (A)** ECO start/stop function (▷ page 118)
- HOLD** HOLD function (▷ page 146)

Menus and submenus

Menu overview

Using the ◀ or ▶ button on the steering wheel, open the menu bar.

Operating the on-board computer (▷ page 165).

- ① Permanent display: outside temperature or speed (▷ page 175)
- ② Time
- ③ Text field

Depending on the equipment installed in the vehicle, you can call up the following menus:

- **Trip** menu (▷ page 168)
- **Navi** menu (navigation instructions) (▷ page 169)
- **Audio** menu (▷ page 170)
- **Tel** menu (telephone) (▷ page 171)
- **DriveAssist** menu (assistance) (▷ page 172)
- **Serv.** menu (▷ page 174)
- **Sett.** menu (settings) (▷ page 175)

The displays for the **Audio**, **Navi** and **Tel** menus may differ slightly from those in your vehicle.

The examples given in this Operator's Manual apply to vehicles equipped with COMAND.

Trip menu

Standard display



- ▶ Press and hold the button on the steering wheel until the **Trip** menu with trip odometer ① and odometer ② appears.

Trip computer "From Start" or "From Reset"

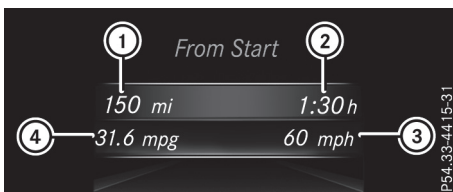

- ① Distance
- ② Driving time
- ③ Average speed
- ④ Average fuel consumption

- ▶ Press the or button on the steering wheel to select the **Trip** menu.
- ▶ Press the or button to select **From Start** or **From Reset**.

The values in the **From Start** submenu are calculated from the start of a journey whilst the values in the **From Reset** submenu are calculated from the last time the submenu was reset (▷ page 169).

In the following cases, the trip computer is automatically reset **From Start**:

- the ignition has been switched off for more than four hours.
- 999 hours have been exceeded.
- 9,999 miles have been exceeded.

When 9,999 hours or 99,999 miles have been exceeded, the trip computer is automatically reset **From Reset**.

ECO display

- ▶ Press the or button on the steering wheel to select the **Trip** menu.
- ▶ Press the or button to select **ECO DISPLAY**.

If the ignition remains switched off for longer than four hours, the ECO display will be automatically reset.

For more information on the ECO display, see (▷ page 133).

Displaying the range and current fuel consumption

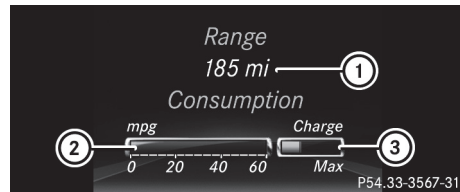

- ▶ Press the or button on the steering wheel to select the **Trip** menu.
- ▶ Press or to select the display with approximate range ① and current fuel consumption ②.





Approximate range ① that can be covered is calculated according to your current driving style and the amount of fuel in the tank. If there is only a small amount of fuel left in the

fuel tank, a vehicle being refueled  appears instead of approximate range ①.

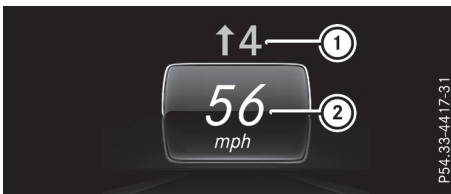



Recuperation display ③ shows you if energy has been recuperated from the kinetic energy in overrun mode and saved in the battery. Recuperation display ③ depends on the engine installed and is therefore not available in all vehicles.

Digital speedometer



- ▶ Press the  or  button on the steering wheel to select the **Trip** menu.
 - ▶ Press the  or  button to select the digital speedometer ②.
- A gear shift recommendation ① ↑ can also follow.
- Observe the information on gearshift recommendation ① when shifting manually (> page 125).

Resetting values

- ▶ Press the  or  button on the steering wheel to select the **Trip** menu.
- ▶ Press the  or  button to select the function that you wish to reset.
- ▶ Press **OK** to confirm.
- ▶ Press  to select **Yes** and press **OK** to confirm.

You can reset the values of the following functions:

- Trip odometer
- "From Start" trip computer
- "From Reset" trip computer
- ECO display



If you reset the values in the ECO display, the values in the "From Start" trip computer are also reset. If you reset the values in the "From Start" trip computer, the values in the ECO display are also reset.

Navigation system menu

Displaying navigation instructions

In the **Navi** menu, the multifunction display shows navigation instructions.

You can find further information on navigation in the Digital Operator's Manual for the multimedia system.

- ▶ Switch on the multimedia system (see the Digital Operator's Manual)
- ▶ Press the  or  button on the steering wheel to select the **Navi** menu.

Route guidance not active



- ① Direction of travel
- ② Current road

Route guidance active

No change of direction announced

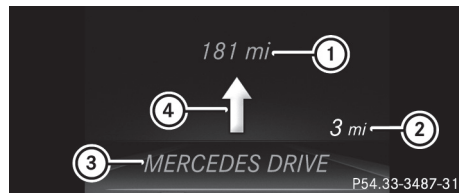

- ① Distance to destination
- ② Distance to the next change of direction
- ③ Current road
- ④ "Follow the road's course" symbol

Change of direction without lane recommendation

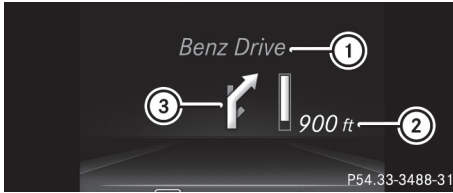

- ① Road into which the change of direction leads
- ② Distance to change of direction and visual distance display
- ③ Change-of-direction symbol

When a change of direction is to be made, you will see symbol ③ for the change of direction and distance graphic ②. The distance indicator shortens towards the top of the display as you approach the point of the announced change of direction. The change of direction starts once the distance display reaches zero.

Change of direction announced with a lane recommendation

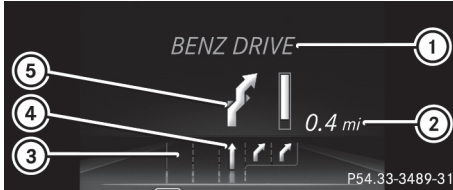

- ① Road into which the change of direction leads
- ② Distance to change of direction and visual distance display
- ③ Lanes not recommended
- ④ Recommended lane and new lane during a change of direction
- ⑤ Change-of-direction symbol

On multilane roads, new lane recommendations can be displayed for the next change of direction if the digital map supports this data. During the change of direction, new lanes may be added.

Lane not recommended ③: you will not be able to complete the next change of direction if you stay in this lane.

Recommended lane and new lane during a change of direction ④: in this lane you will be able to complete the next two changes of direction without changing lane.

Other status indicators of the navigation system



The navigation system displays additional information and the vehicle status.

Possible displays:

- **New Route...** or **Calculating Route**

A new route is calculated.

- **Road Not Mapped**

The vehicle position is inside the area of the digital map but the road is not recognized, e.g. newly built streets, car parks or private land.

- **No Route**

No route could be calculated to the selected destination.

- 

You have reached the destination or an intermediate destination.





Audio menu

Selecting a radio station



- ① Active station list
- ② Station frequency with memory position

The multifunction display shows station ② with station frequency or station name. The preset position is only displayed along with station ② if this has been stored.

- ▶ Switch on the multimedia system and select radio (see the Digital Operator's Manual).
- ▶ Press the  or  button on the steering wheel to select the **Audio** menu.
- ▶ **To select a preset list or station list:** press and briefly hold the  or  button until

the preset list or station list in the desired frequency range is shown.

- ▶ **To select a station:** briefly press or .

i SIRIUS XM satellite radio functions like a normal radio.

You can find further information on operation in the "Satellite radio" section of the Digital Operator's Manual for the multimedia system.

Operating an audio player or audio media



① Current title

Audio data from various audio devices or media can be played, depending on the equipment installed in the vehicle.

- ▶ Switch on the multimedia system and switch on CD or MP3 mode (see the Digital Operator's Manual).
- ▶ Press the or button on the steering wheel to select the **Audio** menu.
- ▶ **To select the next/previous track:** briefly press the or button.
- ▶ **To select a track from the track list (rapid scrolling):** press and hold the or button until desired track appears.

If you press and hold or , the rapid scrolling speed is increased. Not all audio drives or data carriers support this function.

If track information is stored on the audio device or medium, the multifunction display will show the number and title of the track.

Video DVD operation

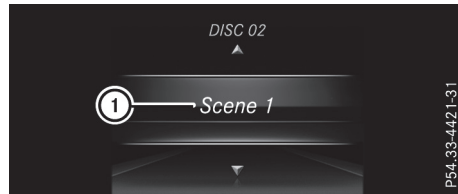

You can only operate DVD videos in the **Audio** menu in vehicles with COMAND.

- ▶ Switch on COMAND and select DVD Video (see the Digital Operator's Manual).
- ▶ Press the or button on the steering wheel to select the **Audio** menu.
- ▶ **To select the next or previous scene:** briefly press the or button.
- ▶ **To select a scene from the scene list (rapid scrolling):** press and hold the or button until desired scene ① appears.

Telephone menu

Introduction



WARNING

If you operate information systems and communication equipment integrated in the vehicle when driving, you may be distracted from the traffic situation. You could also lose control of the vehicle. There is a risk of an accident.

Only operate this equipment when the traffic situation permits. If you are not sure that this is possible, park the vehicle paying attention to traffic conditions and operate the equipment when the vehicle is stationary.

When telephoning, you must observe the legal requirements for the country in which you are currently driving.

- ▶ Switch on the mobile phone (see the manufacturer's operating instructions).
- ▶ Switch on the multimedia system (see the Digital Operator's Manual)

- ▶ Establish a Bluetooth® connection to the multimedia system (see the Digital Operator's Manual).
- ▶ Press the  or  button on the steering wheel to select the **Te1** menu.

You will see one of the following display messages in the multifunction display:

- **Phone READY** or the name of the network provider: the mobile phone has found a network and is ready to receive.
- **Phone No Service**: there is no network available or the mobile phone is searching for a network.

Accepting a call

If someone calls you when you are in the **Te1** menu, a display message appears in the multifunction display.

You can accept a call at any time, even if you are not in the **Te1** menu.









- ▶ Press the  button on the steering wheel to accept an incoming call.

Rejecting or ending a call







You can end or reject a call anytime, even if you are not in the **Te1** menu.

- ▶ Press the  button on the steering wheel to reject or end a call.

Selecting an entry in the phone book









- ▶ Press the  or  button on the steering wheel to select the **Te1** menu.
 - ▶ Press the ,  or **OK** button to switch to the phone book.
 - ▶ Authorize access to the phone book on the phone.
 - ▶ Press the  or  button to select the desired name.
- or
- ▶ **To begin rapid scrolling**: press and hold the  or  button for longer than one second. Rapid scrolling stops when you release the button or reach the end of the list.
 - ▶ **If only one telephone number is stored for a name**: press the  or **OK** button to start dialing.

or

- ▶ **If there is more than one number for a particular name**: press the  or **OK** button to display the numbers.
 - ▶ Press the  or  button to select the number you want to dial.
 - ▶ Press the  or **OK** button to start dialing.
- or
- ▶ **If you do not want to make a call**: press the  or  button.

Redialing

The on-board computer saves the last names or numbers dialed in the redial memory.

- ▶ Press the  or  button on the steering wheel to select the **Te1** menu.
 - ▶ Press the  button to switch to the redial memory.
 - ▶ Press the  or  button to select the desired name or number.
 - ▶ Press the  or **OK** button to start dialing.
- or
- ▶ **If you do not want to make the call**: press the  or  button.

Assistance menu

Introduction

Depending on the equipment installed in the vehicle, you have the following options in the **DriveAssist** menu:

- Only vehicles with black and white multifunction display: showing status overview (▷ page 173)
- Only vehicles with black and white multifunction display: showing distance display (▷ page 173)
- Only vehicles with color multifunction display: showing the assistance graphic (▷ page 173)
- Deactivating/activating ESP® (▷ page 173)
- Activating/deactivating Active Brake Assist (▷ page 174)
- Activating/deactivating ATTENTION ASSIST (▷ page 174)
- Activating/deactivating Blind Spot Assist (▷ page 174)
- Activating/deactivating Lane Keeping Assist (▷ page 174)

Showing the status overview

The **Status Overview** is only available in vehicles with black and white multifunction displays.

- ▶ Press the or button on the steering wheel to select the **DriveAssist** menu.
- ▶ Press or to select **Status Overview**.
- ▶ Press to confirm.
The **Status Overview** shows you the status of and/or information from the following driving systems or driving safety systems:
 - Active Brake Assist (> page 58)
 - ATTENTION ASSIST (> page 158)
 - Lane Keeping Assist (> page 162)
 - Rear window wiper (> page 101)
- ▶ Press to display the ATTENTION ASSIST assessment.

Showing the distance display

The distance display is only available in vehicles with a black and white multifunction display and Distance Pilot DISTRONIC.

- ▶ Press the or button on the steering wheel to select the **DriveAssist** menu.
- ▶ Press or to select **Distance Display**.
- ▶ Press to confirm.
The distance display of Distance Pilot DISTRONIC appears in the multifunction display (> page 140).

Displaying the assistance graphic



The Assistance graphic is only available in vehicles with a color multifunction display.

- ▶ Press the or button on the steering wheel to select the **DriveAssist** menu.
- ▶ Press or to select **Assist. Graphic**.

- ▶ Press to confirm.
The multifunction display shows the Distance Pilot DISTRONIC distance display in the assistance graphic display.

The assistance graphic displays the status of and information from the following driving systems or driving safety systems:

- Distance Pilot DISTRONIC (> page 140)
- Active Brake Assist (> page 58)
- ATTENTION ASSIST (> page 158)
- Lane Keeping Assist (> page 162)
- Rear window wiper (> page 101)

- ▶ Press to display the ATTENTION ASSIST assessment.

Deactivating/activating ESP®

Observe the important safety notes on ESP® (> page 60).

WARNING

If you deactivate ESP®, ESP® no longer stabilizes the vehicle. There is an increased risk of skidding and an accident.

Only deactivate ESP® in the situations described in the following.

It may be best to deactivate ESP® in the following situations:

- when using snow chains
- in deep snow
- on sand or gravel

For further information about ESP®, see (> page 60).

- ▶ Start the engine.
- ▶ Press the or button on the steering wheel to select the **DriveAssist** menu.
- ▶ Press or to select **ESP**.
- ▶ Press to confirm.
The current selection appears.

- ▶ **To activate/deactivate:** press the button again.







ESP® is deactivated if the warning lamp in the instrument cluster lights up continuously when the engine is running.

If the and warning lamps light up continuously, ESP® is not available due to a malfunction.

Observe the information on warning lamps (▷ page 207).









Observe the information on display messages (▷ page 179).

Activating/deactivating Active Brake Assist

- ▶ Press the  or  button on the steering wheel to select the **DriveAssist** menu.
- ▶ Press the  or  button to select **Brake Assist**.
- ▶ Press **OK** to confirm.
The current selection appears.
- ▶ **To activate/deactivate:** press the **OK** button again.
Vehicles with a black and white multifunction display: when Active Brake Assist is activated, the multifunction display shows the  symbol in the status overview.
Vehicles with a color multifunction display: when Active Brake Assist is deactivated, the multifunction display shows the  symbol in the assistance graphic.





Further information on Active Brake Assist (▷ page 58).

Activating/deactivating ATTENTION ASSIST

- ▶ Press the  or  button on the steering wheel to select the **DriveAssist** menu.
- ▶ Press the  or  button to select **Attention Assist**.
- ▶ Press **OK** to confirm.
The current selection appears.
- ▶ Press **OK** to confirm.
- ▶ Press the  or  button to set **Off**, **Standard** or **Sensitive**.
- ▶ Press the **OK** button to save the setting.
Vehicles with black and white multifunction display: when Lane Keeping Assist is activated, the multifunction display in the status overview shows the  symbol.
Vehicles with color multifunction display: when Lane Keeping Assist is deactivated, the multifunction display shows the  symbol in the assistance graphic.







For further information about ATTENTION ASSIST, see (▷ page 158).

Activating/deactivating Blind Spot Assist

- ▶ Press the  or  button on the steering wheel to select the **DriveAssist** menu.
- ▶ Press the  or  button to select **Blind Spot Assist**.
- ▶ Press **OK** to confirm.
The current selection appears.
- ▶ **To activate/deactivate:** press the **OK** button again.

For further information about Blind Spot Assist, see (▷ page 160).

Activating/deactivating Lane Keeping Assist

- ▶ Press the  or  button on the steering wheel to select the **DriveAssist** menu.
- ▶ Press the  or  button to select **Lane Keeping Assist**.
- ▶ Press **OK** to confirm.
The current selection appears.
- ▶ Press **OK** again to confirm.
- ▶ Press the  or  button to set **Off**, **Standard** or **Adaptive**.
- ▶ Press the **OK** button to save the setting.
Vehicles with a black and white multifunction display: when Lane Keeping Assist is activated, the multifunction display in the status overview shows the  symbol.
Vehicles with a color multifunction display: when Lane Keeping Assist is activated, the multifunction display shows the lane markings as bright lines in the assistance graphic.

For further information about Lane Keeping Assist, see (▷ page 162).

Service menu

Depending on the equipment installed in the vehicle, you have the following options in the **Serv.** menu:

- Calling up display messages in message memory (▷ page 178)
- Restarting the tire pressure loss warning system (Canada only) (▷ page 276)
- Calling up the service due date (▷ page 243)

Settings menu

Introduction

Depending on the equipment installed in the vehicle, you have the following options in the **Sett.** menu:

- Changing the instrument cluster settings
- Changing the vehicle settings
- Changing the convenience settings
- Restoring the factory settings

Instrument cluster

Selecting the distance unit

The **Display Unit Speed-/Odometer:** function allows you to choose whether certain displays appear in kilometers or miles in the multifunction display.

- ▶ Press the **◀** or **▶** button on the steering wheel to select the **Sett.** menu.
- ▶ Press the **▼** or **▲** button to select the **Instrument Cluster** submenu.
- ▶ Press **OK** to confirm.
- ▶ Press the **▼** or **▲** button to select the **Display Unit Speed-/Odometer** function. You will see the selected setting: **km** or **miles**.
- ▶ Press the **OK** button to save the setting.

The selected unit of measurement for distance applies to:

- Digital speedometer in the **Trip** menu
- Odometer and the trip odometer
- Trip computer
- Current fuel consumption and approximate range
- Navigation instructions in the **Navi** menu
- Cruise control
- Distance Pilot DISTRONIC
- ASSYST PLUS service interval display

Switching the additional speedometer on/off

If the additional speedometer is switched on, the speed is shown in the status bar in the multifunction display instead of the outside temperature.

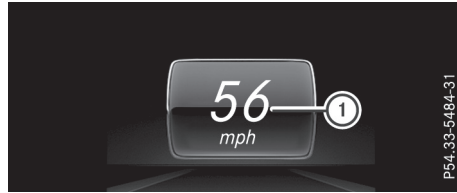

The speed display ① is an alternative to your speedometer.

- ▶ Press the **◀** or **▶** button on the steering wheel to select the **Sett.** menu.
- ▶ Press the **▼** or **▲** button to select the **Instrument Cluster** submenu.
- ▶ Press **OK** to confirm.
- ▶ Press the **▼** or **▲** button to select the **Speedometer [km/h]** or **Speedometer [mph]** function. You will see the selected setting: **On** or **Off**.
- ▶ Press the **OK** button to save the setting.

Selecting permanent display

The **Permanent Display:** function allows you to choose whether the multifunction display always shows the outside temperature or the speed.

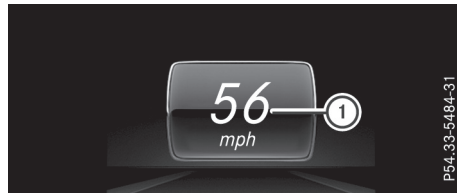







The speed display ① is an alternative to your speedometer.

- ▶ Press the **◀** or **▶** button on the steering wheel to select the **Sett.** menu.
- ▶ Press the **▼** or **▲** button to select the **Instrument Cluster** submenu.
- ▶ Press **OK** to confirm.
- ▶ Press the **▼** or **▲** button to select the **Permanent Display:** function. The current setting, **Outside Temperature** or **Speedometer [km/h]/Speedometer [mph]**, appears.
- ▶ Press the **OK** button to save the setting.

Lights

Switching the daytime running lamps on/off

This function is not available in Canada.

- ▶ Press the  or  button on the steering wheel to select the **Sett.** menu.
- ▶ Press the  or  button to select the **Light** submenu.
- ▶ Press **OK** to confirm.
- ▶ Press the  or  button to select the **Daytime Running Lights** function.







Vehicles with black and white multifunction display: the current setting: **Enabled** or **Disabled** appears.

Vehicles with a color multifunction display: if the **Daytime Running Lights** function has been switched on, the multifunction display shows the cone of light and the  symbol in orange.
- ▶ Press the **OK** button to save the setting.

Further information on daytime running lamps (▷ page 93).

Vehicle

Activating/deactivating the automatic door locking mechanism

- ▶ Press the  or  button on the steering wheel to select the **Sett.** menu.
- ▶ Press the  or  button to select the **Vehicle** submenu.
- ▶ Press **OK** to confirm.
- ▶ Press  or  to select the **Automatic Door Lock**: function (vehicles with a black and white multifunction display) or the **Automatic Door Lock** function (vehicles with a color multifunction display).

Vehicles with black and white multifunction display: the current setting: **Enabled** or **Disabled** appears.

Vehicles with color multifunction display: if the **Automatic Door Lock** function is switched on, the multifunction display shows the doors in orange.
- ▶ Press the **OK** button to save the setting.







If you select the **Automatic Door Lock**: function (vehicles with black and white multifunction display) or the **Automatic Door Lock** function (vehicles with color multifunction display), the

vehicle is centrally locked above a speed of approximately 9 mph (15 km/h).

For further information on the automatic locking feature, see (▷ page 71).

Activating/deactivating the acoustic locking verification signal

If you activate the **Acoustic Lock Feedback**: function (vehicles with a black and white multifunction display) or the **Acoustic Lock** function (vehicles with a color multifunction display), an acoustic tone sounds when you lock the vehicle.

- ▶ Press the  or  button on the steering wheel to select the **Sett.** menu.
- ▶ Press the  or  button to select the **Vehicle** submenu.
- ▶ Press **OK** to confirm.
- ▶ Press  or  to select the **Acoustic Lock Feedback**: function (vehicles with a black and white multifunction display) or the **Acoustic Lock** function (vehicles with a color multifunction display).

Vehicles with black and white multifunction display: the current setting: **Enabled** or **Disabled** appears.

Vehicles with a color multifunction display: if the **Acoustic Lock** function is activated, the multifunction display shows the  symbol in orange.
- ▶ Press the **OK** button to save the setting.

Comfort









Switching the fold-in mirrors when locking feature on/off

This function is only available when the vehicle is equipped with the electrical fold-in function.









If you switch on the **Auto. Mirror Folding** function (vehicles with black and white multifunction display) or the **Auto. Mirror Folding** function (vehicles with color multifunction display), the exterior mirrors fold in when you lock the vehicle. If you unlock the vehicle and then open the driver's or front-passenger door, the exterior mirrors fold out again.

If you have switched on the **Auto. Mirror Folding** (vehicles with black and white multifunction display) or **Auto. Mirror Folding** (vehicles with color multifunction display) function and you fold in the exterior mirrors using the button on the door (▷ page 89), they will not fold

out automatically. The exterior mirrors can then only be folded out using the button on the door.

- ▶ Press the  or  button on the steering wheel to select the **Sett.** menu.
 - ▶ Press the  or  button to select the **Convenience** submenu.
 - ▶ Press  to confirm.
 - ▶ Press  or  to select the **Auto. Mirror Folding** function (vehicles with a black and white multifunction display) or the **Auto. Mirror Folding** function (vehicles with a color multifunction display).
Vehicles with black and white multifunction display: the current setting: **Enabled** or **Disabled** appears.
- Vehicles with color multifunction display: if the **Auto. Mirror Folding** function is switched on, the multifunction display shows the exterior mirror in orange.
- ▶ Press the  button to save the setting.

Restoring the factory settings

- ▶ Press the  or  button on the steering wheel to select the **Sett.** menu.
- ▶ Press the  or  button to select the **Factory Setting** submenu.
- ▶ Press  to confirm.
The **Reset All Settings?** function appears.
- ▶ Press the  or  button to select **No** or **Yes**.
- ▶ Press the  button to confirm the selection.
If you have selected **Yes**, the multifunction display shows a confirmation message.

For safety reasons, the **Daytime Running Lights** function in the **Light** submenu is only reset if the vehicle is stationary.

Display messages

Introduction

General notes

Display messages appear in the multifunction display.

Display messages with graphic displays may be shown in simplified form in the Operator's Manual and may therefore differ from the multifunction display.

Please respond in accordance with the display messages and follow the additional notes in this Operator's Manual.

Certain display messages are accompanied by an audible warning tone or a continuous tone.

When the ignition is switched off, all display messages are deleted, apart from some high-priority display messages. Once the causes of the high-priority display messages have been rectified, the corresponding display messages are also deleted.

When you stop and park the vehicle, please observe the notes on:

- HOLD function (▷ page 146)
- Parking (▷ page 129)

Hiding display messages







- ▶ Press the  or  button on the steering wheel.
The multifunction display hides the display message.

The multifunction display shows high-priority display messages in red. Some high-priority display messages cannot be hidden.











The multifunction display shows these messages continuously until the causes for the messages have been remedied.







Message memory



















The on-board computer saves certain display messages in the **message memory**. You can call up the display messages:









- ▶ Press the  or  button on the steering wheel to select the **Serv.** menu.
If there are display messages, the multifunction display shows **2 Messages**, for example.
- ▶ Press the  or  button to select the entry, e.g. **2 Messages**.
- ▶ Press  to confirm.
- ▶ Press the  or  button to scroll through the display messages.













Safety systems











| Display messages | Possible causes/consequences and ► Solutions |
|--|--|
|   <p>Currently Unavailable See Operator's Manual</p> | <p>ABS (Anti-lock Braking System), BAS (Brake Assist), ESP® (Electronic Stability Program), the HOLD function and hill start assist are temporarily unavailable.</p> <p>Active Brake Assist may have also failed.</p> <p>In addition, the ,  and  warning lamps may light up in the instrument cluster.</p> <p>ATTENTION ASSIST is deactivated.</p> <p>Possible causes are:</p> <ul style="list-style-type: none"> • Self-diagnosis is not yet complete • The on-board voltage may be insufficient <p>⚠ WARNING</p> <p>The brake system continues to function normally, but without the functions listed above. The wheels could therefore lock if you brake hard, for example.</p> <p>The steerability and braking characteristics may be severely affected. The braking distance in an emergency braking situation can increase. If ESP® is not operational, ESP® is unable to stabilize the vehicle. There is an increased risk of skidding and an accident.</p> <p>► Carefully drive on a suitable stretch of road, making gentle steering movements at speeds of above 12 mph (20 km/h). If the display message disappears, the functions mentioned above are available again.</p> <p>If the multifunction display still shows the display message:</p> <ul style="list-style-type: none"> ► Drive on carefully. ► Visit a qualified specialist workshop immediately. |
|   <p>Inoperative See Operator's Manual</p> | <p>ABS, BAS, ESP®, the HOLD function and hill start assist are not available due to a malfunction.</p> <p>Active Brake Assist may have also failed.</p> <p>The , ,  and BRAKE (USA only) or  (Canada only) warning lamps in the instrument cluster may also light up.</p> <p>ATTENTION ASSIST is deactivated.</p> <p>⚠ WARNING</p> <p>The brake system continues to function normally, but without the functions listed above. The wheels could therefore lock if you brake hard, for example.</p> <p>The steerability and braking characteristics may be severely affected. The braking distance in an emergency braking situation can increase. If ESP® is not operational, ESP® is unable to stabilize the vehicle. There is an increased risk of skidding and an accident.</p> <ul style="list-style-type: none"> ► Drive on carefully. ► Visit a qualified specialist workshop immediately. |







| Display messages | Possible causes/consequences and ► Solutions |
|--|--|
|  <p data-bbox="181 318 414 396">Currently Unavailable See Operator's Manual</p> | <p data-bbox="439 270 1076 324">ESP®, BAS, the HOLD function and hill start assist are temporarily unavailable.</p> <p data-bbox="439 329 834 356">Active Brake Assist may have also failed.</p> <p data-bbox="439 361 1071 415">In addition, the  and  warning lamps may light up in the instrument cluster.</p> <p data-bbox="439 421 773 448">ATTENTION ASSIST is deactivated.</p> <p data-bbox="439 453 1054 480">The self-diagnosis function might not be complete, for example.</p> <p data-bbox="452 485 602 512">▲ WARNING</p> <p data-bbox="439 530 1071 584">The brake system continues to function normally, but without the functions listed above.</p> <p data-bbox="439 589 1063 643">The braking distance in an emergency braking situation can thus increase.</p> <p data-bbox="439 648 1067 702">If ESP® is not operational, ESP® is unable to stabilize the vehicle. There is an increased risk of skidding and an accident.</p> <p data-bbox="439 707 1102 811">► Carefully drive a suitable distance, making slight steering movements at a speed above 12 mph (20 km/h). If the display message disappears, the functions mentioned above are available again.</p> <p data-bbox="439 817 1014 844">If the multifunction display still shows the display message:</p> <ul data-bbox="439 849 939 915" style="list-style-type: none"> ► Drive on carefully. ► Visit a qualified specialist workshop immediately. |
|  <p data-bbox="181 982 388 1041">Inoperative See Operator's Manual</p> | <p data-bbox="439 933 1102 987">ESP®, BAS, the HOLD function and hill start assist are unavailable due to a malfunction.</p> <p data-bbox="439 992 834 1019">Active Brake Assist may have also failed.</p> <p data-bbox="439 1025 1071 1078">In addition, the  and  warning lamps may light up in the instrument cluster.</p> <p data-bbox="439 1084 773 1111">ATTENTION ASSIST is deactivated.</p> <p data-bbox="452 1116 602 1143">▲ WARNING</p> <p data-bbox="439 1161 1071 1214">The brake system continues to function normally, but without the functions listed above.</p> <p data-bbox="439 1220 1063 1274">The braking distance in an emergency braking situation can thus increase.</p> <p data-bbox="439 1279 1067 1333">If ESP® is not operational, ESP® is unable to stabilize the vehicle. There is an increased risk of skidding and an accident.</p> <ul data-bbox="439 1338 939 1404" style="list-style-type: none"> ► Drive on carefully. ► Visit a qualified specialist workshop immediately. |







| Display messages | Possible causes/consequences and ► Solutions |
|--|---|
|  <p>Inoperative See Operator's Manual</p> | <p>EBD (electronic brake force distribution), ABS, BAS, ESP®, the HOLD function and hill start assist are not available due to a malfunction. Active Brake Assist may have also failed. A warning tone sounds. In addition, the  and  warning lamps may light up in the instrument cluster.</p> <p>▲ WARNING</p> <p>The brake system continues to function normally, but without the functions listed above. The front and rear wheels could therefore lock if you brake hard, for example. The steerability and braking characteristics may be severely affected. The braking distance in an emergency braking situation can increase. If ESP® is not operational, ESP® is unable to stabilize the vehicle. There is an increased risk of skidding and an accident.</p> <ul style="list-style-type: none"> ► Drive on carefully. ► Visit a qualified specialist workshop immediately. |
| <p> (USA only)  (Canada only)</p> <p>Turn On the Ignition to Release the Parking Brake</p> | <p>The red  (USA only) or  (Canada only) indicator lamp lights up. You attempted to release the electric parking brake while the ignition was switched off.</p> <ul style="list-style-type: none"> ► SmartKey: turn the SmartKey to position  in the ignition lock. ► KEYLESS-GO: switch on the ignition. |
| <p> (USA only)  (Canada only)</p> <p>Please Release Parking Brake</p> | <p>The red  (USA only) or  (Canada only) indicator lamp flashes and a warning tone sounds. A condition for automatic release of the electric parking brake is not fulfilled (► page 131). You are driving with the electric parking brake applied.</p> <ul style="list-style-type: none"> ► Release the electric parking brake manually. <p>The red  (USA only) or  (Canada only) indicator lamp flashes and a warning tone sounds. You are using the electric parking brake for emergency braking (► page 131).</p> |
| <p> (USA only)  (Canada only)</p> <p>Parking Brake See Operator's Manual</p> | <p>The yellow  warning lamp lights up. The electric parking brake is malfunctioning.</p> <p>To apply:</p> <ul style="list-style-type: none"> ► Switch the ignition off. ► Push and hold the electric parking brake handle for at least ten seconds. ► Shift the transmission to position . ► Consult a qualified specialist workshop. |

| Display messages | Possible causes/consequences and ► Solutions |
|------------------|---|
| | <p>The yellow  warning lamp and the red  (USA only) or  (Canada only) indicator lamp light up. The electric parking brake is malfunctioning.</p> <p>To release:</p> <ul style="list-style-type: none"> ► Switch off the ignition and turn it back on. ► Release the electric parking brake manually. <p>or</p> <ul style="list-style-type: none"> ► Release the electric parking brake automatically (▷ page 130). <p>If the electric parking brake still cannot be released:</p> <ul style="list-style-type: none"> ► Do not drive on. ► Consult a qualified specialist workshop. <hr/> <p>The red  (USA only) or  (Canada only) indicator lamp flashes and the yellow  warning lamp lights up. The electric parking brake is malfunctioning.</p> <p>To release:</p> <ul style="list-style-type: none"> ► Switch off the ignition and turn it back on. ► Release the electric parking brake manually. <p>To apply:</p> <ul style="list-style-type: none"> ► Switch off the ignition and turn it back on. ► Apply the electric parking brake manually. <p>If the red  (USA only) or  (Canada only) indicator lamp continues to flash:</p> <ul style="list-style-type: none"> ► Do not drive on. ► Secure the vehicle against rolling away (▷ page 287). ► Shift the transmission to position . ► Turn the front wheels towards the curb. ► Consult a qualified specialist workshop. |

| Display messages | Possible causes/consequences and ► Solutions |
|--|--|
| | <p>The yellow  warning lamp lights up. The red indicator lamp  (USA only) or  (Canada only) flashes for about ten seconds after the electric parking brake has been applied or released. It then goes out or remains lit.</p> <p>The electric parking brake is malfunctioning.</p> <ul style="list-style-type: none"> ► Switch off the ignition and turn it back on. ► Apply the electric parking brake. <p>If it is not possible to apply the electric parking brake:</p> <ul style="list-style-type: none"> ► Shift the transmission to position . ► Visit a qualified specialist workshop. <p>If it is not possible to release the electric parking brake manually:</p> <ul style="list-style-type: none"> ► Release the electric parking brake automatically (> page 130). <p>If the electric parking brake still cannot be released:</p> <ul style="list-style-type: none"> ► Consult a qualified specialist workshop. |
| <p> (USA only)  (Canada only)</p> <p>Parking Brake Inoperative</p> | <p>The yellow  warning lamp lights up. If you manually apply or release the electric parking brake, the red  (USA only) or  (Canada only) indicator lamp flashes.</p> <p>The electric parking brake is malfunctioning. It is not possible to apply the electric parking brake manually.</p> <ul style="list-style-type: none"> ► Shift the transmission to position  as the electric parking brake is not applied automatically. ► Visit a qualified specialist workshop. <p>The yellow  warning lamp lights up. The red indicator lamp  (USA only) or  (Canada only) flashes for about ten seconds after the electric parking brake has been applied or released. It then goes out or remains lit.</p> <p>The electric parking brake is malfunctioning, e.g. because of overvoltage or undervoltage.</p> <ul style="list-style-type: none"> ► Remove the cause for the overvoltage or undervoltage, e.g. by charging the battery or restarting the engine. ► Apply or release the electric parking brake. <p>If it remains impossible to apply or release the electric parking brake:</p> <ul style="list-style-type: none"> ► Switch off the ignition and turn it back on. ► Apply or release the electric parking brake. <p>If the electric parking brake still cannot be released:</p> <ul style="list-style-type: none"> ► Consult a qualified specialist workshop. <p>If the electric parking brake still cannot be applied:</p> <ul style="list-style-type: none"> ► Visit a qualified specialist workshop. |

| Display messages | Possible causes/consequences and ► Solutions |
|---|--|
| | <p>The yellow  warning lamp lights up and the red  (USA only) or  (Canada only) indicator lamp flashes.</p> <p>It is not possible to apply the electric parking brake manually.</p> <ul style="list-style-type: none"> ► Shift the transmission to position . ► Visit a qualified specialist workshop. |
| <p> (USA only)  (Canada only) Check Brake Fluid Level</p> | <p>There is not enough brake fluid in the brake fluid reservoir. A warning tone sounds. The  (USA only) or  (Canada only) warning lamps in the instrument cluster may also light up.</p> <p> WARNING</p> <p>The braking effect may be impaired. There is a risk of an accident.</p> <ul style="list-style-type: none"> ► Pull over and stop the vehicle safely as soon as possible, paying attention to road and traffic conditions. Do not continue driving under any circumstances. ► Secure the vehicle against rolling away (▷ page 129). ► Consult a qualified specialist workshop. ► Do not add brake fluid. This does not correct the malfunction. |
| <p> Check Brake Pad Wear</p> | <p>The brake pads/linings have reached their wear limit.</p> <ul style="list-style-type: none"> ► Visit a qualified specialist workshop. |
| <p>Active Brake Assist Functions Currently Limited See Operator's Manual</p> | <p>Active Brake Assist is temporarily inoperative. Possible causes are:</p> <ul style="list-style-type: none"> • the radar sensor system is temporarily inoperative, e.g. due to electromagnetic radiation emitted by nearby TV or radio stations or other sources of electromagnetic radiation • the system is outside the operating temperature range • the on-board voltage is too low <p>When the causes stated above no longer apply, the display message disappears.</p> <p>Active Brake Assist is operational again.</p> <p>If the display message does not disappear:</p> <ul style="list-style-type: none"> ► Pull over and stop the vehicle safely as soon as possible, paying attention to road and traffic conditions. ► Secure the vehicle against rolling away (▷ page 129). ► Restart the engine. |
| <p>Active Brake Assist: System Inoperative</p> | <p>Active Brake Assist is unavailable due to a malfunction. Situation-dependent braking assistance may also have failed.</p> <ul style="list-style-type: none"> ► Visit a qualified specialist workshop immediately. |

| Display messages | Possible causes/consequences and ► Solutions |
|--|--|
| <p>Radar Sensors Dirty See Operator's Manual</p> | <p>The radar sensor system is malfunctioning. Possible causes are:</p> <ul style="list-style-type: none"> • dirt on sensors • heavy rain or snow • when driving on inter-urban roads without traffic or infrastructure, e.g. in desert-like areas <p>At least one driving system or driving safety system is malfunctioning or is temporarily unavailable:</p> <ul style="list-style-type: none"> • Active Brake Assist • Distance Pilot DISTRONIC <p>A warning tone also sounds.</p> <p>Once the cause of the problem is no longer present, the driving and drive safety systems will be available again. The display message disappears.</p> <p>If the display message does not disappear:</p> <ul style="list-style-type: none"> ► Pull over and stop the vehicle safely as soon as possible, paying attention to road and traffic conditions. ► Secure the vehicle against rolling away (► page 129). ► Switch off the engine. ► Clean all sensors (► page 248). ► Restart the engine. The display message disappears. |
| <p> SRS Malfunction Service Required</p> | <p>The restraint system is malfunctioning. The  warning lamp also lights up in the instrument cluster.</p> <p> WARNING</p> <p>The air bags or Emergency Tensioning Devices may either be triggered unintentionally or, in the event of an accident, may not be triggered. There is an increased risk of injury.</p> <ul style="list-style-type: none"> ► Visit a qualified specialist workshop immediately. <p>For further information about the restraint system, see (► page 37).</p> |
| <p> Front Left Malfunction Service Required or Front Right Malfunction Service Required</p> | <p>The restraint system is malfunctioning at the front on the left or right. The  warning lamp also lights up in the instrument cluster.</p> <p> WARNING</p> <p>The air bags or Emergency Tensioning Devices may either be triggered unintentionally or, in the event of an accident, may not be triggered. There is an increased risk of injury.</p> <ul style="list-style-type: none"> ► Visit a qualified specialist workshop immediately. |

| Display messages | Possible causes/consequences and ► Solutions |
|--|---|
|  <p>Rear Left Malfunction Service Required or Rear Right Malfunction Service Required</p> | <p>The rear left-hand or right-hand restraint system is malfunctioning. The  warning lamp also lights up in the instrument cluster.</p> <p>⚠ WARNING</p> <p>The air bags or Emergency Tensioning Devices may either be triggered unintentionally or, in the event of an accident, may not be triggered. There is an increased risk of injury.</p> <p>► Visit a qualified specialist workshop immediately.</p> |
|  <p>Rear Center Malfunction Service Required</p> | <p>The rear center restraint system is malfunctioning. The  warning lamp also lights up in the instrument cluster.</p> <p>⚠ WARNING</p> <p>The air bags or Emergency Tensioning Devices may either be triggered unintentionally or, in the event of an accident, may not be triggered. There is an increased risk of injury.</p> <p>► Visit a qualified specialist workshop immediately.</p> |
|  <p>Left Side Curtain Airbag Malfunction Service Required or Right Side Curtain Airbag Malfunction Service Required</p> | <p>The left-hand or right-hand window curtain air bag is malfunctioning. The  warning lamp also lights up in the instrument cluster.</p> <p>⚠ WARNING</p> <p>The left or right window curtain air bag may either be triggered unintentionally or, in the event of an accident, may not be triggered. There is an increased risk of injury.</p> <p>► Visit a qualified specialist workshop immediately.</p> |







| Display messages | Possible causes/consequences and ► Solutions |
|---|---|
| <p>Front Passenger Air-bag Disabled See Operator's Manual</p> | <p>The front-passenger front air bag is deactivated during the journey, even though:</p> <ul style="list-style-type: none"> • an adult or • a person of the corresponding stature is on the front-passenger seat <p>If additional forces are applied to the seat, the system may interpret the occupant's weight as lower than it actually is.</p> <p>⚠ WARNING</p> <p>The front-passenger front air bag does not deploy during an accident. There is an increased risk of injury.</p> <ul style="list-style-type: none"> ► Pull over and stop the vehicle safely as soon as possible, paying attention to road and traffic conditions. ► Secure the vehicle against rolling away (► page 129). ► Switch the ignition off. ► Have the occupant on the front-passenger seat get out of the vehicle. ► Keep the seat unoccupied, close the front-passenger door and switch on the ignition. ► Observe the PASSENGER AIR BAG indicator lamps in the center console and the multifunction display and check the following: <ul style="list-style-type: none"> Seat unoccupied and ignition switched on: <ul style="list-style-type: none"> • a self-diagnosis is carried out. The PASSENGER AIR BAG OFF and PASSENGER AIR BAG ON indicator lamps light up simultaneously for approximately six seconds • the PASSENGER AIR BAG OFF indicator lamp must then light up and remain lit after the self-diagnosis. If the indicator lamp is on, OCS (Occupant Classification System) has disabled the front-passenger front air bag (► page 45) • the Front Passenger Airbag Enabled See Operator's Manual or Front Passenger Airbag Disabled See Operator's Manual display messages must not be shown on the multifunction display ► Wait for a period of at least 60 seconds until the necessary system checks have been completed. ► Make sure that the display messages do not appear in the multifunction display. <p>If these conditions are fulfilled, the front-passenger seat can be occupied again. Whether the PASSENGER AIR BAG OFF or ON indicator lamp remains lit or goes out depends on how OCS classifies the occupant.</p> <p>If the conditions are not fulfilled, the system is not operating correctly.</p> <ul style="list-style-type: none"> ► Visit a qualified specialist workshop immediately. <p>For further information about the Occupant Classification System, see (► page 45).</p> |









| Display messages | Possible causes/consequences and ► Solutions |
|---|--|
| <p>Front Passenger Airbag Enabled See Operator's Manual</p> | <p>The front-passenger front air bag is activated during the journey, even though:</p> <ul style="list-style-type: none"> • a child, a small adult or an object weighing less than the system's weight threshold is located on the front-passenger seat or • the front-passenger seat is unoccupied <p>The system may detect objects or forces applying additional weight on the seat.</p> <p> WARNING</p> <p>The front-passenger front air bag may deploy unintentionally. There is an increased risk of injury.</p> <ul style="list-style-type: none"> ► Pull over and stop the vehicle safely as soon as possible, paying attention to road and traffic conditions. ► Secure the vehicle against rolling away (▷ page 129). ► Switch the ignition off. ► Open the front-passenger door. ► Remove the child and the child restraint system from the front-passenger seat. ► Make sure that there are no objects on the seat adding to the weight. The system might otherwise detect the additional weight and interpret the seat occupant's weight as greater than it actually is. ► Keep the seat unoccupied, close the front-passenger door and switch on the ignition. ► Observe the PASSENGER AIR BAG indicator lamps in the center console and the multifunction display and check the following: <ul style="list-style-type: none"> Seat unoccupied and ignition switched on: <ul style="list-style-type: none"> • a self-diagnosis is carried out. The PASSENGER AIR BAG OFF and PASSENGER AIR BAG ON indicator lamps light up simultaneously for approximately six seconds • the PASSENGER AIR BAG OFF indicator lamp must then light up and remain lit after the self-diagnosis. If the indicator lamp is on, OCS has disabled the front-passenger front air bag (▷ page 45) • the Front Passenger Airbag Enabled See Operator's Manual or Front Passenger Airbag Disabled See Operator's Manual display messages must not be shown on the multifunction display ► Wait for a period of at least 60 seconds until the necessary system checks have been completed. ► Make sure that the display messages do not appear in the multifunction display. <p>If these conditions are fulfilled, the front-passenger seat can be occupied again. Whether the PASSENGER AIR BAG OFF or ON indicator lamp remains lit or goes out depends on how OCS classifies the occupant.</p> <p>If the conditions are not fulfilled, the system is not operating correctly.</p> |







| Display messages | Possible causes/consequences and ► Solutions |
|------------------|---|
| | <p>► Visit a qualified specialist workshop immediately.</p> <p>For further information about the Occupant Classification System, see (► page 45).</p> |

Lights



- i** Vehicles with LED bulbs in the light clusters:
 The display message for the corresponding lamp only appears when all of the LEDs in the lamp have failed.

| Display messages | Possible causes/consequences and ► Solutions |
|--|---|
|  <p>Check Left Low Beam or Check Right Low Beam</p> | <p>The left or right-hand low-beam headlamp is defective.</p> <p>► Halogen headlamp: replace the bulb (► page 96).</p> <p>► LED headlamps: consult a qualified specialist workshop.</p> |
|  <p>Check Rear Left Turn Signal or Check Rear Right Turn Signal</p> | <p>The rear left-hand or rear right-hand turn signal is defective.</p> <p>► Tail lamps (vehicles with halogen headlamps): replace the bulb (► page 96).</p> <p>► Tail lamps (vehicles with LED headlamps): consult a qualified specialist workshop.</p> |
|  <p>Check Front Left Turn Signal or Check Front Right Turn Signal</p> | <p>The front left-hand or front right-hand turn signal is defective.</p> <p>► Halogen headlamp: replace the bulb (► page 96).</p> <p>► LED headlamps: consult a qualified specialist workshop.</p> |
|  <p>Check Left Mirror Turn Signal or Check Right Mirror Turn Signal</p> | <p>The turn signal in the left-hand or right-hand exterior mirror is defective.</p> <p>► Visit a qualified specialist workshop.</p> |
|  <p>Check Center Brake Lamp</p> | <p>The high-mounted brake lamp is faulty.</p> <p>► Visit a qualified specialist workshop.</p> |
|  <p>Check Left Brake Lamp or Check Right Brake Lamp</p> | <p>The left or right-hand brake lamp is defective.</p> <p>► Visit a qualified specialist workshop.</p> |

| Display messages | Possible causes/consequences and ► Solutions |
|--|---|
|  <p>Check Left Tail and Brake Lamps or Check Right Tail and Brake Lamps</p> | <p>The left or right-hand tail lamp/brake lamp is defective.</p> <p>► Visit a qualified specialist workshop.</p> |
|  <p>Check Left High Beam or Check Right High Beam</p> | <p>The left or right-hand high beam is defective.</p> <p>► Halogen headlamp: replace the bulb (▷ page 96).</p> <p>► LED headlamps: consult a qualified specialist workshop.</p> |
|  <p>License Plate Lamp</p> | <p>The left or right-hand license plate lamp is faulty.</p> <p>► Check whether you are permitted to replace the bulb yourself (▷ page 96).</p> <p>or</p> <p>► Visit a qualified specialist workshop.</p> |
|  <p>Rear Fog Lamp</p> | <p>The rear fog lamp is faulty.</p> <p>► Tail lamps (vehicles with halogen headlamps): replace the bulb (▷ page 96).</p> <p>► Tail lamps (vehicles with LED headlamps): consult a qualified specialist workshop.</p> |
|  <p>Check Front Left Parking Lamp or Check Front Right Parking Lamp</p> | <p>The front left or front right parking or standing lamp is defective.</p> <p>► Visit a qualified specialist workshop.</p> |
|  <p>Backup Light</p> | <p>The backup lamp is defective.</p> <p>► Tail lamps (vehicles with halogen headlamps): replace the bulb (▷ page 96).</p> <p>► Tail lamps (vehicles with LED headlamps): consult a qualified specialist workshop.</p> |
|  <p>Check Left Tail Lamp or Check Right Tail Lamp</p> | <p>The left or right-hand tail lamp is defective.</p> <p>► Visit a qualified specialist workshop.</p> |
|  <p>Check Front Left Sidemarkers Lamp or Check Front Right Sidemarkers Lamp</p> | <p>The front left-hand or front right-hand side marker lamp is faulty.</p> <p>► Visit a qualified specialist workshop.</p> |

| Display messages | Possible causes/consequences and ► Solutions |
|--|---|
|  <p>Check Rear Left Sidemarker Lamp or Check Rear Right Sidemarker Lamp</p> | <p>The rear left-hand or rear right-hand side marker lamp is faulty.</p> <ul style="list-style-type: none"> ► Visit a qualified specialist workshop. |
|  <p>Check Left Daytime Running Light or Check Right Daytime Running Light</p> | <p>The left or right-hand daytime running lamp is faulty.</p> <ul style="list-style-type: none"> ► Visit a qualified specialist workshop. |
|  <p>Malfunction See Operator's Manual</p> | <p>The exterior lighting is malfunctioning.</p> <ul style="list-style-type: none"> ► Visit a qualified specialist workshop. |
|  <p>Auto Lamp Function Inoperative</p> | <p>The light sensor is defective.</p> <ul style="list-style-type: none"> ► Visit a qualified specialist workshop. |
|  <p>Switch Off Lights</p> | <p>The lights are still switched on when you leave the vehicle. A warning tone also sounds.</p> <ul style="list-style-type: none"> ► Turn the light switch to the AUTO position. |
|  <p>Switch On Headlamps</p> | <p>You are driving with low-beam headlamps switched off.</p> <ul style="list-style-type: none"> ► Turn the light switch to the  or AUTO position. |

Engine

| Display messages | Possible causes/consequences and ► Solutions |
|--|--|
|  <p>Check Coolant Level See Operator's Manual</p> | <p>The coolant level is too low.</p> <ul style="list-style-type: none"> ! Avoid making long journeys with too little coolant in the engine cooling system. The engine will otherwise be damaged. ► Add coolant, observing the warning notes before doing so (► page 242). <p>If you have to add coolant frequently:</p> <ul style="list-style-type: none"> ► Contact a qualified specialist workshop and have the engine cooling system checked. |
|  | <p>The fan motor is malfunctioning.</p> <ul style="list-style-type: none"> ► At coolant temperatures below 248 °F (120 °C), drive to the nearest qualified specialist workshop. ► Avoid heavy loads on the engine as you do so, e.g. driving in mountainous terrain and stop-and-go traffic. |

Display messages



Coolant Too Hot
Stop Vehicle Turn
Engine Off

Possible causes/consequences and ► Solutions

The coolant is too hot.
A warning tone also sounds.

 **WARNING**

Do not drive when your engine is overheated. This can cause some fluids which may have leaked into the engine compartment to catch fire.

Steam from the overheated engine can also cause serious burns which can occur just by opening the hood.

There is a risk of injury.

- Pull over and stop the vehicle safely and switch off the engine, paying attention to road and traffic conditions.
- Secure the vehicle against rolling away (► page 129).
- Wait until the engine has cooled down.
- Make sure that the air supply to the engine radiator is not blocked, e.g. by snow, slush or ice.
- Do not start the engine again until the display message goes out and the coolant temperature is below 248 °F (120 °C). Otherwise, the engine could be damaged.
- Pay attention to the coolant temperature gauge.

If the temperature increases again:

- Visit a qualified specialist workshop immediately.

Under normal operating conditions and with the specified coolant level, the coolant temperature may rise to 248 °F (120 °C).



See Operator's Manual

The battery is not being charged.







A warning tone also sounds.



Possible causes are:



- a defective alternator
- a torn poly-V-belt
- a malfunction in the electronics

! Do not continue driving. The engine could otherwise overheat.

- Pull over and stop the vehicle safely and switch off the engine, paying attention to road and traffic conditions.
- Secure the vehicle against rolling away (► page 129).
- Consult a qualified specialist workshop.

| Display messages | Possible causes/consequences and ► Solutions |
|---|--|
|  <p>Stop Vehicle See Operator's Manual</p> | <p>The battery is no longer being charged and the condition of charge is too low. A warning tone also sounds.</p> <ul style="list-style-type: none"> ► Pull over and stop the vehicle safely and switch off the engine, paying attention to road and traffic conditions. ► Secure the vehicle against rolling away (▷ page 129). ► Observe the instructions in the display message  See Operator's Manual. ► Consult a qualified specialist workshop. |
|  <p>Check Engine Oil At Next Refueling</p> | <p>The engine oil level has dropped to the minimum level. A warning tone also sounds.</p> <ul style="list-style-type: none"> ! Avoid long journeys with too little engine oil. The engine will otherwise be damaged. ► Check the oil level when next refueling, at the latest (▷ page 240). ► If necessary, add engine oil (▷ page 241). <p>If the engine oil needs topping up more often:</p> <ul style="list-style-type: none"> ► Contact a qualified specialist workshop and have the engine checked. <p>Information on approved engine oils can be obtained from any qualified specialist workshop or on the Internet at http://bevo.mercedes-benz.com.</p> |
|  <p>Fuel Level Low</p> | <p>The fuel level has dropped into the reserve range. ► Refuel at the nearest gas station.</p> |
|  | <p>There is only a very small amount of fuel in the fuel tank. ► Refuel at the nearest gas station without fail.</p> |
|  <p>Gas Cap Loose</p> | <p>The fuel filler cap is not closed correctly or the fuel system is leaking. ► Check that the fuel filler cap is correctly closed.</p> <p>If the fuel filler cap is not correctly closed:</p> <ul style="list-style-type: none"> ► Close the fuel filler cap. <p>If the fuel filler cap is correctly closed:</p> <ul style="list-style-type: none"> ► Visit a qualified specialist workshop. |

| Driving systems | |
|--|--|
| Display messages | Possible causes/consequences and ► Solutions |
|  <p>Attention Assist: Take a Break!</p> | <p>Based on certain criteria, ATTENTION ASSIST has detected fatigue or a lack of concentration on the part of the driver. A warning tone also sounds.</p> <p>► If necessary, take a break.</p> <p>During long journeys, take regular breaks in good time so you get enough rest.</p> |
|  <p>Attention Assist Inoperative</p> | <p>ATTENTION ASSIST is inoperative.</p> <p>► Visit a qualified specialist workshop.</p> |
|  <p>HOLD Off</p> | <p>The HOLD function is deactivated. The vehicle is skidding. A warning tone also sounds.</p> <p>► Reactivate the HOLD function later (▷ page 147).</p> <p>The HOLD function is deactivated. When the brake pedal is firmly depressed, an activation condition is not fulfilled. A warning tone also sounds.</p> <p>► Check the activation conditions for the HOLD function (▷ page 147).</p> |
| <p>Lane Keeping Assist Currently Unavailable See Operator's Manual</p> | <p>Lane Keeping Assist is deactivated and temporarily inoperative. Possible causes are:</p> <ul style="list-style-type: none"> • the windshield in the camera's field of vision is dirty • visibility is impaired due to heavy rain, snow or fog • there have been no lane markings for an extended period • the lane markings are worn away, dark or covered up, e.g. by dirt or snow. <p>When the causes stated above no longer apply, the display message disappears.</p> <p>Lane Keeping Assist is operational again.</p> <p>If the display message does not disappear:</p> <p>► Pull over and stop the vehicle safely as soon as possible, paying attention to road and traffic conditions.</p> <p>► Secure the vehicle against rolling away (▷ page 129).</p> <p>► Clean the windshield.</p> |
| <p>Lane Keeping Assist Inoperative</p> | <p>Lane Keeping Assist is faulty.</p> <p>► Visit a qualified specialist workshop.</p> |

| Display messages | Possible causes/consequences and ► Solutions |
|--|--|
| <p>Blind Spot Assist Currently Unavailable See Operator's Manual</p> | <p>Blind Spot Assist is temporarily inoperative. Possible causes are:</p> <ul style="list-style-type: none"> • the radar sensor system is temporarily inoperative, e.g. due to electromagnetic radiation emitted by nearby TV or radio stations or other sources of electromagnetic radiation • the radar sensor system is outside the operating temperature range <p>The yellow  indicator lamps also light up in the exterior mirrors. When the causes stated above no longer apply, the display message disappears. Blind Spot Assist is operational again. If the display message does not disappear:</p> <ul style="list-style-type: none"> ► Pull over and stop the vehicle safely as soon as possible, paying attention to road and traffic conditions. ► Secure the vehicle against rolling away (▷ page 129). ► Restart the engine. |
| <p>Blind Spot Assist Inoperative</p> | <p>Blind Spot Assist is malfunctioning. The yellow  indicator lamps also light up in the exterior mirrors.</p> <ul style="list-style-type: none"> ► Visit a qualified specialist workshop. |
| <p>Parking Pilot Canceled</p> | <p>The driver's door is open and the driver's seat belt has not been fastened.</p> <ul style="list-style-type: none"> ► Repeat the parking process with the seat belt fastened and the driver's door closed. <p>You have inadvertently touched the multifunction steering wheel while steering intervention was active.</p> <ul style="list-style-type: none"> ► While steering intervention is active, make sure that the multifunction steering wheel is not touched unintentionally. <p>The vehicle has started to skid and ESP® has intervened.</p> <ul style="list-style-type: none"> ► Use Parking Pilot again later (▷ page 151). |
| <p>Parking Pilot Inoperative</p> | <p>You have just carried out a large number of turning or parking maneuvers. Parking Pilot will become available again after approximately ten minutes (▷ page 151).</p> <ul style="list-style-type: none"> ► Pull over and stop the vehicle safely as soon as possible, paying attention to road and traffic conditions. ► Switch off and restart the engine. <p>If the multifunction display still shows the display message:</p> <ul style="list-style-type: none"> ► Visit a qualified specialist workshop. <p>Parking Assist PARKTRONIC is malfunctioning.</p> <ul style="list-style-type: none"> ► Visit a qualified specialist workshop. |









| Display messages | Possible causes/consequences and ► Solutions |
|--|---|
| Parking Pilot Finished | The vehicle is parked. A warning tone also sounds. The display message disappears automatically. |
| Distance Pilot Off | Distance Pilot DISTRONIC is deactivated (▷ page 144). If it was not deactivated by the driver, a warning tone also sounds. |
| Distance Pilot Now Available | Distance Pilot DISTRONIC is operational again after having been temporarily unavailable. You can now reactivate Distance Pilot DISTRONIC (▷ page 141). |
| Distance Pilot Currently Unavailable See Operator's Manual | Distance Pilot DISTRONIC is temporarily inoperative. Possible causes are: <ul style="list-style-type: none"> • the radar sensor system is temporarily inoperative, e.g. due to electromagnetic radiation emitted by nearby TV or radio stations or other sources of electromagnetic radiation • the system is outside the operating temperature range • the on-board voltage is too low. A warning tone also sounds. When the causes stated above no longer apply, the display message disappears. Distance Pilot DISTRONIC is operational again. If the display message does not disappear: <ul style="list-style-type: none"> ► Pull over and stop the vehicle safely as soon as possible, paying attention to road and traffic conditions. ► Secure the vehicle against rolling away (▷ page 129). ► Restart the engine. |
| Distance Pilot Inoperative | Distance Pilot DISTRONIC is malfunctioning. Adaptive Brake Assist may also have failed. A warning tone also sounds. ► Visit a qualified specialist workshop. |
| Distance Pilot Suspended | You have depressed the accelerator pedal. Distance Pilot DISTRONIC is no longer controlling the speed of the vehicle. ► Remove your foot from the accelerator pedal. |
| Distance Pilot - - - mph | A condition for activating Distance Pilot DISTRONIC has not been met. ► Check the activation conditions for Distance Pilot DISTRONIC (▷ page 141). |







| Display messages | Possible causes/consequences and ► Solutions |
|-----------------------------|---|
| Cruise Control Inoperative | <p>Cruise control is malfunctioning. A warning tone also sounds.</p> <p>► Visit a qualified specialist workshop.</p> |
| Cruise Control - - - mph | <ul style="list-style-type: none"> • A condition for activating cruise control has not been fulfilled. You have tried to store a speed below 20 mph (30 km/h), for example. • ESP® is deactivated. The yellow ESP® OFF warning lamp is lit. <p>► If conditions permit, drive faster than 20 mph (30 km/h) and store the speed.</p> <p>or</p> <p>► Check the activation conditions for cruise control (► page 139).</p> <p>or</p> <p>► Reactivate ESP® (► page 173).</p> |



| Tires | |
|---|--|
| Display messages | Possible causes/consequences and ► Solutions |
| Check Tire Pressure Soon | <p>The tire pressure loss warning system has detected a significant loss in pressure. A warning tone also sounds. Possible causes:</p> <ul style="list-style-type: none"> • you have changed the positions of the wheels and tires or installed new wheels and tires • the tire pressure in one or more tires has dropped <p> WARNING</p> <p>Tire pressures that are too low pose the following hazards:</p> <ul style="list-style-type: none"> • they may burst, especially as the load and vehicle speed increase. • they may wear excessively and/or unevenly, which may greatly impair tire traction. • the driving characteristics, as well as steering and braking, may be greatly impaired. <p>There is a risk of an accident.</p> <ul style="list-style-type: none"> ► Stop the vehicle without making any sudden steering or braking maneuvers. Pay attention to the traffic conditions as you do so. ► Secure the vehicle against rolling away (▷ page 129). ► Check the tires and, if necessary, follow the instructions for a flat tire (▷ page 253). ► Check the tire pressures and, if necessary, correct the tire pressure. ► Restart the tire pressure loss warning system when the tire pressure is correct (▷ page 276). |
| Check Tire Pressure Then Restart Run Flat Indicator | <p>The tire pressure loss warning system generated a display message and has not been restarted since.</p> <ul style="list-style-type: none"> ► Set the correct tire pressure in all four tires. ► Restart the tire pressure loss warning system (▷ page 276). |
| Run Flat Indicator Inoperative | <p>The tire pressure loss warning system is faulty.</p> <ul style="list-style-type: none"> ► Visit a qualified specialist workshop. |

| Vehicle | |
|--|--|
| Display messages | Possible causes/consequences and ► Solutions |
| Depress Brake to Start Engine | <p>You have attempted to start the engine with the transmission in position N without depressing the brake pedal.</p> <ul style="list-style-type: none"> ► Depress the brake pedal. |
| To Deselect P or N, Depress Brake and Start Engine | <p>You have attempted to shift the transmission to position R or D without starting the engine.</p> <ul style="list-style-type: none"> ► Start the engine. ► Depress the brake pedal. <p>i It is possible to shift the transmission from position P to the desired position only if you depress the brake pedal. Only then can the parking lock be deactivated. If you do not depress the brake pedal, the DIRECT SELECT lever can still be moved but the parking lock remains engaged.</p> <p>i At transmission fluid temperatures below -4 °F (-20 °C) you can only shift out of position P into another transmission position when the engine is running.</p> |
| Apply Brake to Shift from 'P' | <p>You attempted to shift the transmission to position R, N or D without depressing the brake pedal.</p> <ul style="list-style-type: none"> ► Depress the brake pedal. |
| Transmission Not in P Risk of Vehicle Rolling Away | <p>The driver's door is open or not fully closed and the transmission is in position R, N or D. A warning tone also sounds.</p> <p>⚠ WARNING</p> <p>The vehicle may roll away. There is a risk of an accident.</p> <ul style="list-style-type: none"> ► Shift the transmission to position P. ► Secure the vehicle against rolling away (▷ page 129). ► Close the driver's door completely. |
| Service Required Do Not Shift Gears Visit Dealer | <p>You cannot change the transmission position due to a malfunction. A warning tone also sounds.</p> <p>If transmission position D is selected:</p> <ul style="list-style-type: none"> ► Drive to a qualified specialist workshop without shifting the transmission from position D. <p>If position R, N or P is selected:</p> <ul style="list-style-type: none"> ► Secure the vehicle against rolling away (▷ page 129). ► Notify a qualified specialist workshop or breakdown service. |
| Only Shift to 'P' when Vehicle is Stationary | <p>The vehicle is moving.</p> <ul style="list-style-type: none"> ► Pull over and stop the vehicle safely as soon as possible, paying attention to road and traffic conditions. ► Shift the transmission to position P. |

| Display messages | Possible causes/consequences and ► Solutions |
|--|--|
| To Engage Trans- miss. Position R First Depress the Brake | You have attempted to shift from position D or N to position R . ► Shift the transmission to position R with the brake pedal depressed. |
| Reversing Not Possi- ble Service Required | The automatic transmission is malfunctioning. You cannot back up. ► Visit a qualified specialist workshop. |
| Transmission Mal- function | The automatic transmission is malfunctioning. ► Visit a qualified specialist workshop. |
| Transmission Mal- function Stop | The automatic transmission is malfunctioning. ► Pull over and stop the vehicle safely as soon as possible, paying attention to road and traffic conditions. ► Secure the vehicle against rolling away (▷ page 129). ► Consult a qualified specialist workshop. |
| Stop Vehicle Shift to P Leave Engine Running | The automatic transmission has overheated. ► Drive on carefully. The automatic transmission is available again when the display message goes out. If the multifunction display still shows the display message: ► Pull over and stop the vehicle safely as soon as possible, paying attention to road and traffic conditions. ► Secure the vehicle against rolling away (▷ page 129). ► Wait until the automatic transmission has cooled down and the display message has disappeared. |
| Auxiliary Battery Malfunction | The auxiliary battery for the automatic transmission is no longer being charged. ► Visit a qualified specialist workshop. ► Until then, always shift the transmission to position P before you switch off the engine. ► Before leaving the vehicle, apply the electric parking brake. |
| 4matic Currently Unavailable | 4MATIC has overheated. The vehicle is only driven by the front wheels. ► Drive on. The airflow cools 4MATIC more quickly. When the display message goes out, 4MATIC is available again and the vehicle is driven by all four wheels. |
| 4matic Inoperative | 4MATIC is malfunctioning. The vehicle is only driven by the front wheels. ► Visit a qualified specialist workshop. |

| Display messages | Possible causes/consequences and ► Solutions |
|---|---|
|  | <p>The tailgate is open</p> <p> WARNING</p> <p>When the engine is running, exhaust gases can enter the vehicle interior if the tailgate is open. There is a risk of poisoning.</p> <p>► Close the tailgate.</p> |
|  | <p>The hood is open. A warning tone also sounds.</p> <p> WARNING</p> <p>The open hood may block your view when the vehicle is in motion. There is a risk of an accident.</p> <p>► Pull over and stop the vehicle safely as soon as possible, paying attention to road and traffic conditions.</p> <p>► Secure the vehicle against rolling away (▷ page 129).</p> <p>► Close the hood.</p> |
|  | <p>At least one door is open. A warning tone also sounds.</p> <p>► Close all the doors.</p> |
|  <p>Power Steering Malfunction See Operator's Manual</p> | <p>The power steering is malfunctioning. A warning tone also sounds.</p> <p> WARNING</p> <p>You will need to use more force to steer. There is a risk of an accident.</p> <p>► Check whether you are able to apply the extra force required.</p> <p>If you are able to steer safely:</p> <p>► Drive on carefully.</p> <p>► Visit a qualified specialist workshop immediately.</p> <p>If you are unable to steer safely:</p> <p>► Do not drive on.</p> <p>► Consult a qualified specialist workshop.</p> |
| <p>Phone No Service</p> | <p>Your vehicle is outside the network provider's transmitter/receiver range.</p> <p>► Wait until the mobile phone operational readiness symbol appears in the multifunction display.</p> |
|  <p>Check Washer Fluid</p> | <p>The washer fluid level in the washer fluid reservoir has dropped below the minimum.</p> <p>► Add washer fluid (▷ page 242).</p> |

| Display messages | Possible causes/consequences and ► Solutions |
|--|--|
| Wiper Malfunctioning | The windshield wipers are malfunctioning. ► Visit a qualified specialist workshop. |
| Hazard Warning Flashers Malfunctioning | The hazard warning lamps are faulty. ► Visit a qualified specialist workshop. |
| SmartKey | |
| Display messages | Possible causes/consequences and ► Solutions |
|  Key Does Not Belong to Vehicle | You have put the wrong SmartKey in the ignition lock. ► Use the correct SmartKey. |
|  Take Your Key from Ignition | The SmartKey is in the ignition lock. A warning tone sounds ► Remove the SmartKey. |
|  Obtain a New Key | The SmartKey needs to be replaced. ► Visit a qualified specialist workshop. |
|  Replace Key Battery | The SmartKey battery is discharged. ► Change the battery (► page 67). |
|  Don't Forget Your Key | The display message is shown for a maximum of 60 seconds and is only a reminder. You have opened the driver's door with the engine switched off. The SmartKey is not in the ignition lock. A warning tone sounds. ► Take the SmartKey with you when you leave the vehicle. |
|  Key Not Detected (red display message) | The SmartKey is not in the vehicle. A warning tone also sounds. If the engine is switched off, you can no longer lock the vehicle centrally or start the engine. ► Pull over and stop the vehicle safely as soon as possible, paying attention to road and traffic conditions. ► Secure the vehicle against rolling away (► page 129). ► Locate the SmartKey. |

| Display messages | Possible causes/consequences and ► Solutions |
|---|---|
| | <p>Because there is interference from a strong source of radio waves, the SmartKey is not detected whilst the engine is running. A warning tone also sounds.</p> <ul style="list-style-type: none"> ► Pull over and stop the vehicle safely as soon as possible, paying attention to road and traffic conditions. ► Secure the vehicle against rolling away (▷ page 129). ► Insert the SmartKey into the ignition lock and drive in SmartKey mode. |
|  <p>Key Not Detected (white display message)</p> | <p>The SmartKey is currently undetected.</p> <ul style="list-style-type: none"> ► Change the location of the SmartKey in the vehicle. <p>If the SmartKey still cannot be detected:</p> <ul style="list-style-type: none"> ► Operate the vehicle with the SmartKey in the ignition lock. |
|  <p>Remove 'Start' Button and Insert Key</p> | <p>The SmartKey is continually undetected. The SmartKey detection function has a temporary malfunction or is faulty. A warning tone also sounds.</p> <ul style="list-style-type: none"> ► Insert the SmartKey into the ignition lock and turn it to the desired position. ► Visit a qualified specialist workshop. |

Warning and indicator lamps in the instrument cluster

General notes

Some systems carry out a self-diagnosis when the ignition is switched on. Therefore, some indicator and warning lamps may light up or flash temporarily. This behavior is non-critical.

These indicator and warning lamps only indicate a malfunction if they light up or flash after starting the engine or whilst driving.

Safety

Seat belts

Warning/
indicator
lamp

▷ Signal type

Possible causes/consequences and ► Solutions



- ▷ After engine start, the red seat belt warning lamp lights up for six seconds. The seat belt warning lamp reminds the driver and front passenger to fasten their seat belts.
- Fasten your seat belt (▷ page 41).



- ▷ After starting the engine, the red seat belt warning lamp lights up. In addition, a warning tone sounds for up to six seconds. The driver's seat belt is not fastened.
- Fasten your seat belt (▷ page 41).
The warning tone ceases.



- ▷ The red seat belt warning lamp lights up after the engine starts, as soon as the driver's or the front-passenger door is closed. The driver or front passenger has not fastened their seat belt.
- Fasten your seat belt (▷ page 41).
The warning lamp goes out.
- There are objects on the front-passenger seat.
- Remove the objects from the front-passenger seat and stow them in a secure place.
The warning lamp goes out.



- ▷ The red seat belt warning lamp flashes and an intermittent audible warning sounds. The driver or front passenger has not fastened their seat belt. The vehicle is being driven faster than 15 mph (25 km/h) or has briefly been driven faster than 15 mph (25 km/h).
- Fasten your seat belt (▷ page 41).
The warning lamp goes out and the intermittent warning tone ceases.
- There are objects on the front-passenger seat. The vehicle is being driven faster than 15 mph (25 km/h) or has briefly been driven faster than 15 mph (25 km/h).
- Remove the objects from the front-passenger seat and stow them in a secure place.
The warning lamp goes out and the intermittent warning tone ceases.

Safety systems

Warning/
indicator
lamp

▷ Signal type

Possible causes/consequences and ▶ Solutions



▷ **BRAKE** (USA only), **(D)** (Canada only): the red brake system warning lamp is lit while the engine is running. A warning tone also sounds.

WARNING

The brake boosting effect is malfunctioning and the braking characteristics may be affected.

There is a risk of an accident.

- ▶ Pull over and stop the vehicle safely as soon as possible, paying attention to road and traffic conditions. Do not continue driving under any circumstances.
- ▶ Secure the vehicle against rolling away (▷ page 129).
- ▶ Consult a qualified specialist workshop.
- ▶ Observe the additional display messages in the multifunction display.



▷ **BRAKE** (USA only), **(D)** (Canada only): the red brake system warning lamp is lit while the engine is running. A warning tone also sounds.

There is not enough brake fluid in the brake fluid reservoir.

WARNING

The braking effect may be impaired.

There is a risk of an accident.

- ▶ Pull over and stop the vehicle safely as soon as possible, paying attention to road and traffic conditions. Do not continue driving under any circumstances.
- ▶ Secure the vehicle against rolling away (▷ page 129).
- ▶ Do not add brake fluid. Adding more will not correct the malfunction.
- ▶ Consult a qualified specialist workshop.
- ▶ Observe the additional display messages in the multifunction display.

Warning/
indicator
lamp

▷ Signal type

Possible causes/consequences and ► Solutions



▷ The yellow ABS warning lamp is lit while the engine is running.

ABS (Anti-lock Braking System) is deactivated due to a malfunction. Therefore, BAS (Brake Assist), Active Brake Assist, ESP® (Electronic Stability Program), the HOLD function and hill start assist, for example, are also deactivated. ATTENTION ASSIST is deactivated.

WARNING

The brake system continues to function normally, but without the functions listed above. The wheels could therefore lock if you brake hard, for example.

The steerability and braking characteristics may be severely affected. The braking distance in an emergency braking situation can increase.

If ESP® is not operational, ESP® is unable to stabilize the vehicle.

There is an increased risk of skidding and an accident.

- ▶ Observe the additional display messages in the multifunction display.
- ▶ Drive on carefully.
- ▶ Visit a qualified specialist workshop immediately.

If the ABS control unit is faulty, there is also a possibility that other systems, such as the navigation system or the automatic transmission, will not be available.



▷ The yellow ABS warning lamp is lit while the engine is running.

ABS is temporarily unavailable. Therefore, BAS, Active Brake Assist, ESP®, EBD (electronic brake force distribution), the HOLD function and hill start assist, for example, are also deactivated.

Possible causes are:

- self-diagnosis is not yet complete
- the on-board voltage may be insufficient

ATTENTION ASSIST is deactivated.

WARNING

The brake system continues to function normally, but without the functions listed above. The front and rear wheels could therefore lock if you brake hard, for example.

The steerability and braking characteristics may be severely affected. The braking distance in an emergency braking situation can increase.

If ESP® is not operational, ESP® is unable to stabilize the vehicle.

There is a risk of an accident.

- ▶ Carefully drive a suitable distance, making slight steering movements at a speed above 12 mph (20 km/h).
The functions mentioned above are available again when the warning lamp goes out.

If the warning lamp is still on:

- ▶ Observe the additional display messages in the multifunction display.
- ▶ Drive on carefully.
- ▶ Visit a qualified specialist workshop immediately.

**Warning/
indicator
lamp****▷ Signal type****Possible causes/consequences and ▶ Solutions**

▷ The yellow ABS warning lamp is lit while the engine is running. A warning tone also sounds.

EBD is malfunctioning. Therefore, ABS, BAS, Active Brake Assist, ESP[®], the HOLD function and hill start assist, for example, are not available either.

ATTENTION ASSIST is deactivated.

WARNING

The brake system continues to function normally, but without the functions listed above. The front and rear wheels could therefore lock if you brake hard, for example.

The steerability and braking characteristics may be severely affected. The braking distance in an emergency braking situation can increase.

If ESP[®] is not operational, ESP[®] is unable to stabilize the vehicle.

There is an increased risk of skidding and an accident.

- ▶ Observe the additional display messages in the multifunction display.
- ▶ Drive on carefully.
- ▶ Visit a qualified specialist workshop immediately.

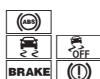

▷ (USA only), (Canada only): the red brake warning lamp and the yellow ABS, ESP[®] and ESP[®] OFF warning lamps are lit while the engine is running.

ABS and ESP[®] are malfunctioning. Therefore, BAS, Active Brake Assist, EBD, the HOLD function and hill start assist, for example, are not available either.

ATTENTION ASSIST is deactivated.

WARNING

The brake system continues to function normally, but without the functions listed above. The front and rear wheels could therefore lock if you brake hard, for example.

The steerability and braking characteristics may be severely affected. The braking distance in an emergency braking situation can increase.

If ESP[®] is not operational, ESP[®] is unable to stabilize the vehicle.

There is an increased risk of skidding and an accident.

- ▶ Observe the additional display messages in the multifunction display.
- ▶ Drive on carefully.
- ▶ Visit a qualified specialist workshop immediately.

**Warning/
indicator
lamp****▷ Signal type****Possible causes/consequences and ► Solutions**

- ▷ The yellow ESP[®] warning lamp flashes while the vehicle is in motion. ESP[®] or traction control has intervened because there is a risk of skidding or at least one wheel has started to spin. Cruise control or Distance Pilot DISTRONIC is deactivated.
- ▶ When pulling away, only depress the accelerator pedal as far as necessary.
 - ▶ Ease off the accelerator pedal while the vehicle is in motion.
 - ▶ Adapt your driving style to suit the road and weather conditions.
 - ▶ Do not deactivate ESP[®].
In rare cases (▷ page 61), it may be best to deactivate ESP[®].
Observe the important safety notes on ESP[®] (▷ page 60).



- ▷ The yellow ESP[®] OFF warning lamp is lit while the engine is running. ESP[®] is deactivated. ESP[®] will not stabilize the vehicle if it starts to skid or if a wheel starts to spin.

⚠ WARNING

If ESP[®] is switched off, ESP[®] is unable to stabilize the vehicle. Further driving systems or driving safety systems are thus restricted. There is an increased risk of skidding and an accident.

- ▶ Reactivate ESP[®].
In rare cases (▷ page 61), it may be best to deactivate ESP[®].
Observe the important safety notes on ESP[®] (▷ page 60).
 - ▶ Adapt your driving style to suit the road and weather conditions.
- If ESP[®] cannot be activated:
- ▶ Drive on carefully.
 - ▶ Contact a qualified specialist workshop and have ESP[®] checked.

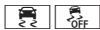

- ▷ The yellow ESP[®] and ESP[®] OFF warning lamps are lit while the engine is running. ESP[®], BAS, Active Brake Assist, the HOLD function and hill start assist are not available due to a malfunction. ATTENTION ASSIST is deactivated.

⚠ WARNING

The brake system continues to function normally, but without the functions listed above.

The braking distance in an emergency braking situation can thus increase.

If ESP[®] is not operational, ESP[®] is unable to stabilize the vehicle.

There is an increased risk of skidding and an accident.

- ▶ Observe the additional display messages in the multifunction display.
- ▶ Drive on carefully.
- ▶ Visit a qualified specialist workshop immediately.

**Warning/
indicator
lamp****▷ Signal type****Possible causes/consequences and ▶ Solutions**

- ▷ The yellow ESP[®] and ESP[®] OFF warning lamps are lit while the engine is running. ESP[®], BAS, the HOLD function and hill start assist are temporarily unavailable. Active Brake Assist may have also failed. ATTENTION ASSIST is deactivated. Self-diagnosis is not yet complete

⚠ WARNING

The brake system continues to function normally, but without the functions listed above.

The braking distance in an emergency braking situation can thus increase.

If ESP[®] is not operational, ESP[®] is unable to stabilize the vehicle.

There is an increased risk of skidding and an accident.

- ▶ Carefully drive a suitable distance, making slight steering movements at a speed above 12 mph (20 km/h).
The functions mentioned above are available again when the warning lamp goes out.

If the warning lamp is still on:

- ▶ Observe the additional display messages in the multifunction display.
- ▶ Drive on carefully.
- ▶ Visit a qualified specialist workshop immediately.



- ▷ **PARK** (USA only), (Canada only): the red indicator lamp for the electric parking brake flashes or lights up and/or the yellow warning lamp for the electric parking brake lights up.

- ▶ Observe the additional display messages in the multifunction display.



- ▷ The red restraint system warning lamp is lit while the engine is running. The restraint system is malfunctioning.

⚠ WARNING

The air bags or Emergency Tensioning Devices may either be triggered unintentionally or, in the event of an accident, may not be triggered.

There is an increased risk of injury.

- ▶ Observe the additional display messages in the multifunction display.
- ▶ Drive on carefully.
- ▶ Contact a qualified specialist workshop and have the restraint system checked.

For further information about the restraint system, see (▷ page 37).

Engine

Warning/
indicator
lamp

▷ Signal type

Possible causes/consequences and ▶ Solutions



▷ The yellow Check Engine warning lamp lights up while the engine is running. There may be a malfunction, for example:

- in the engine management
- in the fuel injection system
- in the exhaust system
- in the ignition system
- in the fuel system

The emission limit values may be exceeded and the engine may be in emergency mode.

▶ Visit a qualified specialist workshop immediately.

- ❗ In some states, you must immediately visit a qualified specialist workshop as soon as the yellow Check Engine warning lamp lights up. This is due to the legal requirements in effect in these states. If in doubt, check whether such legal regulations apply in the state in which you are currently driving.



▷ The yellow reserve fuel warning lamp lights up while the engine is running. The fuel level has dropped into the reserve range.

▶ Refuel at the nearest gas station.



▷ The yellow reserve fuel warning lamp flashes while the vehicle is in motion. In addition, the  Check Engine warning lamp may light up.

The fuel filler cap is not closed correctly or the fuel system is leaking.

- ▶ Check that the fuel filler cap is correctly closed.
- ▶ **If the fuel filler cap is not correctly closed:** close the fuel filler cap.
- ▶ **If the fuel filler cap is closed:** visit a qualified specialist workshop.



▷ The red coolant warning lamp lights up while the engine is running and the coolant temperature gage is at the start of the scale.

The temperature sensor for the coolant temperature gauge is malfunctioning.

The coolant temperature is no longer being monitored. There is a risk of engine damage if the coolant temperature is too high.

- ▶ Pull over and stop the vehicle safely and switch off the engine, paying attention to road and traffic conditions. Do not continue driving under any circumstances.
- ▶ Secure the vehicle against rolling away (▷ page 129).
- ▶ Consult a qualified specialist workshop.

Warning/
indicator
lamp▷ Signal type
Possible causes/consequences and ▶ Solutions

- ▷ The red coolant warning lamp comes on while the engine is running. The coolant level is too low.
- If the coolant level is correct, the airflow to the engine radiator may be blocked or the electric engine radiator fan may be defective.
- The coolant is too hot and the engine is no longer being cooled sufficiently.
- ▶ Observe the additional display messages in the multifunction display.
 - ▶ Pull over and stop the vehicle safely and switch off the engine, paying attention to road and traffic conditions.
 - ▶ Secure the vehicle against rolling away (▷ page 129).
 - ▶ Leave the vehicle and keep a safe distance from the vehicle until the engine has cooled down.
 - ▶ Check the coolant level and add coolant, observing the warning notes (▷ page 242).
 - ▶ If you have to add coolant frequently, have the engine cooling system checked.
 - ▶ Make sure that the air supply to the engine radiator is not blocked, e.g. by snow, slush or ice.
 - ▶ Do not start the engine again until the coolant temperature is below 248 °F (120 °C). Otherwise, the engine could be damaged.
 - ▶ Drive to the nearest qualified specialist workshop.
 - ▶ Avoid heavy loads on the engine as you do so, e.g. driving in mountainous terrain and stop-and-go traffic.



- ▷ The red coolant warning lamp comes on while the engine is running. A warning tone also sounds.

The coolant temperature has exceeded 248 °F (120 °C). The airflow to the engine radiator may be blocked or the coolant level may be too low.

WARNING

The engine is not being cooled sufficiently and may be damaged.

Do not drive when your engine is overheated. This can cause some fluids which may have leaked into the engine compartment to catch fire.

Steam from the overheated engine can also cause serious burns which can occur just by opening the hood.

There is a risk of injury.

- ▶ Observe the additional display messages in the multifunction display.
- ▶ Pull over and stop the vehicle safely and switch off the engine, paying attention to road and traffic conditions.
- ▶ Secure the vehicle against rolling away (▷ page 129).
- ▶ Leave the vehicle and keep a safe distance from the vehicle until the engine has cooled down.
- ▶ Check the coolant level and add coolant, observing the warning notes (▷ page 242).
- ▶ If you have to add coolant frequently, have the engine cooling system checked.
- ▶ Make sure that the air supply to the engine radiator is not blocked, e.g. by snow, slush or ice.

**Warning/
indicator
lamp**▷ **Signal type****Possible causes/consequences and ► Solutions**

- ▶ At coolant temperatures below 248 °F (120 °C), drive to the nearest qualified specialist workshop.
- ▶ Avoid heavy loads on the engine as you do so, e.g. driving in mountainous terrain and stop-and-go traffic.

Driving systems**Warning/
indicator
lamp**▷ **Signal type****Possible causes/consequences and ► Solutions**

▷ The red distance warning lamp lights up while the vehicle is in motion. A warning tone also sounds.

You are approaching a vehicle or a stationary obstacle in your line of travel at too high a speed.

- ▶ Be prepared to brake immediately.
- ▶ Pay careful attention to the traffic situation. You may have to brake or take evasive action.

Further information on the distance warning function of Active Brake Assist (▷ page 58).

General notes

The multimedia system section in this Operator's Manual describes the basic principles for operation. More information can be found in the Digital Operator's Manual.

Important safety notes

WARNING

If you operate information systems and communication equipment integrated in the vehicle when driving, you may be distracted from the traffic situation. You could also lose control of the vehicle. There is a risk of an accident.

Only operate this equipment when the traffic situation permits. If you are not sure that this is possible, park the vehicle paying attention to traffic conditions and operate the equipment when the vehicle is stationary.

You must observe the legal requirements for the country in which you are currently driving when operating the multimedia system.

The multimedia system calculates the route to the destination without taking the following into account, for example:

- traffic lights
- stop and yield signs
- parking or stopping restrictions
- road narrowing
- other road and traffic rules and regulations

The multimedia system may give incorrect navigation recommendations if the actual street/traffic situation does not correspond with the digital map's data.

For example:

- a diverted route
- the road layout or the direction of a one-way street has been changed

For this reason, you must always observe road and traffic rules and regulations during your journey. Road and traffic rules and regulations always have priority over multimedia system driving recommendations.

Navigation announcements are intended to direct you while driving without diverting your attention from the road and driving.

Please always use this feature instead of consulting the map display for directions. Looking at the icons or map display can distract you from traffic conditions and driving, and increase the risk of an accident.

This equipment complies with FCC radiation exposure limits set forth for uncontrolled equipment and meets the FCC radio frequency (RF) Exposure Guidelines in Supplement C to OET65.

This equipment has very low levels of RF energy that is deemed to comply without maximum permissive exposure evaluation (MPE). However, it is recommended to install it at a distance of at least 8 inches (approx. 20 cm) between the radiation source and a person's body (not including limbs such as hands, wrists, feet and legs).

WARNING

Modifications to electronic components, their software as well as wiring can impair their function and/or the function of other networked components. In particular, systems relevant to safety could also be affected. As a result, these may no longer function as intended and/or jeopardize the operating safety of the vehicle. There is an increased risk of an accident and injury.

Never tamper with the wiring as well as electronic components or their software. You should have all work to electrical and electronic equipment carried out at a qualified specialist workshop.

Function restrictions

For safety reasons, some functions are restricted or unavailable while the vehicle is in motion. You will notice this, for example, because either you will not be able to select certain menu items or a message will appear to this effect.

Operating system

Overview

General notes

! Do not use the space in front of the display for storage. Objects placed here could damage the display or impair its function. Avoid any direct contact with the display surface. Pressure on the display surface may result in impairments to the display, which could be irreversible.

Wearing polarized sunglasses may impair your ability to read the display.

The display has an automatic temperature-controlled switch-off feature. The brightness is automatically reduced if the temperature is too high. The display may temporarily switch off completely.

Cleaning instructions

! Do not touch the display. The display has a very sensitive high-gloss surface; there is a risk of scratching. If you have to clean the screen, however, use a mild cleaning agent and a soft, lint-free cloth.

The display must be switched off and have cooled down before you start cleaning. Do not apply pressure to the display surface when cleaning it, as this could cause irreversible damage to the display.

Switching the multimedia system on/off

► Press the  control knob.



Adjusting the volume

► Turn the  control knob.

The volume is adjusted:

- for the currently selected media source
- during traffic or navigation announcements
- in hands-free mode during an active call

Switching the sound on or off

► Press the  button on the control panel. If the audio output is switched off, the status line will show the  symbol. If you switch

the media source or set the volume, the sound is automatically switched on.

i Navigation announcements will be heard even if the sound is muted.

Functions

The multimedia system has the following functions:





- Radio mode
- Media mode with media search
- Sound systems
- Navigation system
 - COMAND: navigation via the hard drive
 - Audio 20: navigation via SD card
- Communication functions
- SIRIUS Weather (COMAND)
- Vehicle functions with system settings
- Favorites functions

Controller

The controller in the center console lets you:

- select menu items on the display
- enter characters
- select a destination on the map
- save entries

The controller can be:

- turned 
- slid left or right 
- slid forwards or back 
- slid diagonally 
- pressed briefly or pressed and held 

Back button

You can use the  button to exit a menu or to call up the main menu of the current operating mode.

► **To exit the menu:** briefly press the  button.

The multimedia system changes to the next higher menu level in the current operating mode.



► **To call up the main menu:** press the  button for longer than two seconds. The multimedia system changes to the main menu of the current operating mode.

Favorites button

You can assign predefined functions using the  favorites button and call them up by pressing the button (▷ page 215).







Favorites

Calling up and exiting favorites

- ▶ **To call up:** press the  button on the controller.
- ▶ Select a favorite, e.g. [Vehicle](#).
The favorites are displayed.
- ▶ **To exit:** press the  button again.

Adding favorites

Adding predefined favorites

- ▶ Press the  button.
- ▶ **COMAND:** slide  the controller.
- ▶ **Audio 20:** slide  or  the controller.
The menu bar is displayed.
- ▶ Select [Reassign](#).
The categories are displayed.
- ▶ Select a category.
The favorites are displayed.
- ▶ Select a favorite.
- ▶ **COMAND:** to add the favorite to the desired position, turn and press the controller.
If a favorite has already been added at this position, it will be overwritten.
- ▶ **Audio 20:** to add the favorite to the desired position, turn, slide  or  and press the controller.
If a favorite has already been added at this position, it will be overwritten.

Adding your own favorites

You can add climate control as a favorite, for example.

- ▶ Select [Vehicle](#) → [Vehicle Settings](#).
- ▶ Press and hold the  button until the favorites are displayed.
- ▶ Add a favorite to the desired position.
If a favorite has already been added at this position, it will be overwritten.

Navigation mode

Important safety notes

WARNING

If you operate information systems and communication equipment integrated in the vehicle when driving, you may be distracted from the traffic situation. You could also lose control of the vehicle. There is a risk of an accident.

Only operate this equipment when the traffic situation permits. If you are not sure that this is possible, park the vehicle paying attention to traffic conditions and operate the equipment when the vehicle is stationary.

You must observe the legal requirements for the country in which you are currently driving when operating the navigation system.

General notes

Among other things, correct functioning of the navigation system depends on GPS reception. In certain situations, GPS reception may be impaired, there may be interference or there may be no reception at all, e.g. in tunnels or parking garages.

Audio 20 is equipped with Garmin® MAP PILOT (see the manufacturer's operating instructions). The Garmin® MAP PILOT operating instructions are stored on the SD card as a PDF file. The SD card box contains a quick guide.

The following descriptions apply to navigation with COMAND. Further information can be found in the Digital Operator's Manual.

Selecting a route type and route options

Multimedia system:

- ▶ Select [Navi](#) → [Navigation](#).
The map shows the vehicle's current position.
- ▶ Slide  the controller.
- ▶ Select [Options](#) → [Route Settings](#).

Notes for route types:

- [Eco Route](#)
- [Dynamic Traffic Route](#)

Traffic reports on the route for the route guidance are taken into account (not available in all countries).

- **Dynamic TRF. Route After Request**

You can decide whether or not current traffic reports should be included in the route calculation (not available in all countries).

- **Calculate Alternative Routes**

Different routes are being calculated. In order to do so, instead of **Start**, select the menu item **Continue**.

- ▶ **To avoid/use route options:** select **Avoid Options**.

- ▶ Select a route option.

Notes for route options:

- **Use Toll Roads**

The route calculation includes roads which require you to pay a usage fee (toll).

- **Number of Occupants in the Vehicle:** (only available in the USA)

Prerequisite: your vehicle meets the access conditions for carpool lanes.

Carpool lanes will be included if the carpool lanes option is activated.

- ▶ Select the location.

If available, the ZIP code is shown. If there are different ZIP codes available for the location, the corresponding digits are displayed with an X.

- ▶ Enter the street and house number. The address is in the menu.

Further options for destination entry:

- search for a keyword

The keyword search finds destinations using fragments of words.

- select the last destination

- select a contact

- select a POI

You can search for a POI by location, name or telephone number.

- select destination on the map

- enter intermediate destination

You can map the route to the destination yourself with up to four intermediate destinations.

- select destinations from Mercedes-Benz Apps

- select geo-coordinates

Entering an address

Multimedia system:

- ▶ Select **Navi** → **Navigation**.

The map shows the vehicle's current position.

- ▶ Slide  the controller.

- ▶ Select **Destination** → **Address Entry**.

Enter an address, e.g. as follows:

- city or ZIP code, street, house number

- state/province, city or ZIP code

- city or ZIP code, center

- street, city or ZIP code, intersection

- ▶ Select **City**.

The city in which the vehicle is currently located (current vehicle position) is at the top. Below this, you will see locations for which route guidance has already been carried out.

- ▶ Enter the city.

The  symbol: the location is contained on the digital map multiple times.

- ▶ **To switch to the list:** slide the  controller.

Calculating the route

Prerequisite: the address has been entered and is in the menu.

- ▶ Select **Start** or **Continue**.

The route is calculated with the selected route type and the selected route options.

If route guidance has already been activated, a prompt will appear asking whether you wish to end the current route guidance.

- ▶ Select **Cancel Active Route Guidance** or **Set as Intermediate Destination**. **Cancel Active Route Guidance** cancels the current route guidance and starts route calculation to the new destination.

Set as Intermediate Destination adds the new destination in addition to the existing destination and opens the intermediate destinations list.

Connecting a mobile phone (COMAND)

Requirements

For telephony via the Bluetooth® interface, you require a Bluetooth®-capable mobile phone. The mobile phone must support Hands-Free Profile 1.0 or above.

Multimedia system:

- ▶ Select **Vehicle** → **System Settings** → **Activate Bluetooth**.
- ▶ Activate Bluetooth® .

Mobile phone:

- ▶ Activate Bluetooth® and, if necessary, Bluetooth® visibility for other devices (see the manufacturer's operating instructions).

The Bluetooth® device names for all of one manufacturer's products might be identical. To make it possible to clearly identify your mobile phone, change the device name (see the manufacturer's operating instructions).

If the mobile phone supports the PBAP (Phone Book Access Profile) and MAP (Message Access Profile) Bluetooth® profiles, the following information will be transmitted after you connect:

- Phone book
- Call lists
- Text messages and e-mail

i Further information on suitable mobile phones can be found at: **http://www.mercedes-benz.com/connect**

i In the USA, you can get in touch with the Mercedes-Benz Customer Assistance Center on 1-800-FOR-MERCedes (1-800-367-6372). In Canada, you can get in touch with the Customer Relations Center on 1-800-387-0100.

Searching for and authorizing (connecting) a mobile phone

Before using your mobile phone with the multimedia system for the first time, you will need to search for the phone and then authorize (connect) it. Depending on the mobile phone, authorization either takes place by means of Secure Simple Pairing or by entering a passkey. The multimedia system automatically makes the

procedure that is relevant for your mobile phone available. The mobile phone is always connected automatically after authorization. Further information on using a mobile phone with the multimedia system (see the Digital Operator's Manual).

If the multimedia system does not detect your mobile phone, this may be due to particular security settings on your mobile phone (see the manufacturer's operating instructions).

Only one mobile phone can be connected to the multimedia system at any one time.



Searching for a mobile phone

Multimedia system:

- ▶ Select **TEL** → **Conn. Device** → **Search for Phones** → **Start Search**.

The available mobile phones are displayed.

Symbols in the device list

| Symbol | Explanation |
|---|---|
|  | New mobile phone found, not yet authorized. |
|  | Mobile phone is authorized, but is not connected. |

Connecting a mobile phone

Authorization using Secure Simple Pairing:

- ▶ Select mobile phone.
 - A code is displayed in the multimedia system and on the mobile phone.
- ▶ **If codes match:** select **Yes** on the multimedia system.
 - Confirm code on the mobile phone. Depending on the mobile phone used, confirm the connection to the multimedia system and for the PBAP and MAP Bluetooth® profiles. The prompt to confirm may take up to two minutes to be displayed (see the manufacturer's operating instructions).
- ▶ **If the codes are different:** select **No** on the multimedia system.
 - The process is canceled.
 - Repeat authorization.

Authorization by entering a passkey (passcode):

- ▶ Select the Bluetooth® name of the mobile phone. The input menu for the passkey is displayed.
- ▶ Choose a one to sixteen-digit number combination as a passkey.
- ▶ Enter the passkey on the multimedia system.
- ▶ Press **ok** to confirm.
- ▶ Enter and confirm the passkey on the mobile phone. Depending on the mobile phone used, confirm the connection to the multimedia system and for the PBAP and MAP Bluetooth® profiles. The prompt to confirm may take up to two minutes to be displayed (see the manufacturer's operating instructions).

Connecting a mobile phone (Audio 20)

Requirements

For telephony via the Bluetooth® interface, you require at least one Bluetooth®-capable mobile phone depending on use of **one-telephone mode** or **two-telephone mode**. The mobile phone must support Hands-Free Profile 1.0 or above.

In **two-telephone mode** you can use all the functions of the multimedia system with the **main telephone**. With the **additional telephone**, you can receive incoming calls.

Multimedia system:

- ▶ Select **Vehicle** → **System Settings** → **Activate Bluetooth**.
- ▶ Activate Bluetooth® .

Mobile phone:

- ▶ Activate Bluetooth® and, if necessary, Bluetooth® visibility for other devices (see the manufacturer's operating instructions).

The Bluetooth® device names for all of one manufacturer's products might be identical. To make it possible to clearly identify your mobile phone, change the device name (see the manufacturer's operating instructions).

If the mobile phone supports the PBAP (**Phone Book Access Profile**) and MAP (**Message Access Profile**) Bluetooth® profiles, the following information is transmitted after you connect the main telephone:

- Phone book
- Call lists
- Text messages and e-mail

i Further information on suitable mobile phones can be found at: **http://www.mercedes-benz.com/connect**

i In the USA, you can get in touch with the Mercedes-Benz Customer Assistance Center on 1-800-FOR-MERcedes (1-800-367-6372). In Canada, you can get in touch with the Customer Relations Center on 1-800-387-0100.

Searching for and authorizing (connecting) a mobile phone

Before using your mobile phone with the multimedia system for the first time, you will need to search for the phone and then authorize (connect) it. Depending on the mobile phone, authorization either takes place by means of Secure Simple Pairing or by entering a passkey. The multimedia system automatically makes the procedure that is relevant for your mobile phone available. The mobile phone is always connected automatically after authorization. Further information on using a mobile phone with the multimedia system (see the Digital Operator's Manual).

If the multimedia system does not detect your mobile phone, this may be due to particular security settings on your mobile phone (see the manufacturer's operating instructions).

Searching for a mobile phone

Multimedia system:

- ▶ Select **Te1** → **Conn. Device** → **Connect New Device**.
- ▶ Select **Connect via Vehicle**.
- ▶ Select mobile phone.

Connecting a mobile phone

- ▶ **One-telephone mode:** select **Connect as New Main Phone**.
- ▶ **Two-telephone mode:** select **Connect as Additional Phone** when a mobile phone is already connected.

▶ **Authorization using Secure Simple Pairing:**

A code is displayed in the multimedia system and on the mobile phone.



- ▶ Confirm code on the mobile phone. Depending on the mobile phone used, confirm the connection to the multimedia system and for the PBAP and MAP Bluetooth® profiles. The prompt to confirm may take up to two minutes to be displayed (see the manufacturer's operating instructions).
- ▶ If the codes are different: select **No** on the multimedia system. The process is canceled. Repeat authorization.

or

- ▶ **Authorization by entering a passkey (passcode):** enter any one- to sixteen-digit number sequence which you have chosen yourself into the passkey input menu.
- ▶ Press  to confirm.
- ▶ Enter and confirm the passkey on the mobile phone. Depending on the mobile phone used, confirm the connection to the multimedia system and for the PBAP and MAP Bluetooth® profiles. The prompt to confirm may take up to two minutes to be displayed (see the manufacturer's operating instructions).

Symbols in the device manager

The symbols are shown in color depending on their use.

| Symbol | Explanation |
|---|---|
|  | Mobile phone connected to the multimedia system |
|  | Main telephone with full range of functions |
|  | Additional telephone for incoming calls in two telephone mode |

Media mode

General notes

If you wish to play external media sources, the appropriate media mode must already be turned on. Further information on media mode (see the Digital Operator's Manual).

The following external media sources can be used:

- Apple® devices (e.g. iPhone®)
- USB devices (e.g. USB stick, MP3 player) (> page 220)
- CD
- DVD (COMAND)
- SD cards
- via devices connected by Bluetooth®

i Information on single CD/DVD drive or DVD changer (see the Digital Operator's Manual).

Selecting using the device list

Multimedia system:

- ▶ Select **Media** → **Devices**. The available media sources will be shown. The **•** dot indicates the current setting.
- ▶ Select the media source. Playable files are played.

Inserting/removing an SD card

Important safety notes

 **WARNING**

SD cards are small parts. They can be swallowed and cause choking. This poses an increased risk of injury or even fatal injury.

Keep the SD card out of the reach of children. If a SD card is swallowed, seek medical attention immediately.

- !** If you are no longer using the SD card, you should remove it and store it outside the vehicle. High temperatures can damage the card.

Inserting an SD card

The SD card slot is located on the control panel.

- ▶ Insert the SD card into the SD card slot until the SD card engages. The side with the contacts must face down.

Removing an SD card

- ▶ Press the SD card. The SD card is ejected.
- ▶ Remove the SD card.

Connecting USB devices

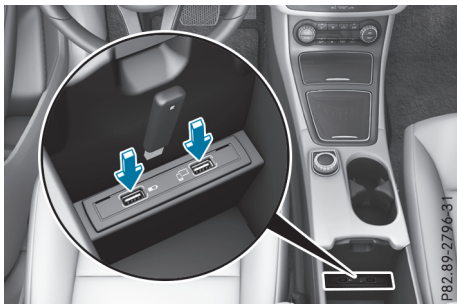

- ▶ Connect the USB device to the USB port.
There are two USB ports in the stowage space under the armrest.
- ▶ Select the media source (▷ page 219).

Loading guidelines

WARNING

If objects, luggage or loads are not secured or not secured sufficiently, they could slip, tip over or be flung around and thereby hit vehicle occupants. There is a risk of injury, particularly in the event of sudden braking or a sudden change in direction.

Always store objects so that they cannot be flung around. Secure objects, luggage or loads against slipping or tipping before the journey.

WARNING

Combustion engines emit poisonous exhaust gases such as carbon monoxide. If the tailgate is open when the engine is running, particularly if the vehicle is moving, exhaust fumes could enter the passenger compartment. There is a risk of poisoning.

Turn off the engine before opening the tailgate. Never drive with the tailgate open.

WARNING

The exhaust tail pipe and tail pipe trim can become very hot. If you come into contact with these parts of the vehicle, you could burn yourself. There is a risk of injury.

Always be particularly careful around the exhaust tail pipe and the tail pipe trim. Allow these components to cool down before touching them.

The handling characteristics of a laden vehicle are dependent on the distribution of the load within the vehicle.

Observe the following notes when loading and transporting a load:

- Never exceed the maximum permissible gross vehicle mass or the gross axle weight rating for the vehicle (including occupants). The values are specified on the vehicle identification plate on the B-pillar of the driver's door.
- The cargo compartment is the preferred place to carry objects.

- Position heavy loads as far forward as possible and as low down in the cargo compartment as possible.
 - The load must not protrude above the upper edge of the seat backrests.
 - Always place the load against the rear or front seat backrests. Make sure that the seat backrests are securely locked into place.
 - Always place the load behind unoccupied seats if possible.
 - Use the cargo tie-down rings and the parcel nets to transport loads and luggage.
 - Use cargo tie-down rings and fastening materials appropriate for the weight and size of the load.
 - Hook in the cargo net when loading.
 - The maximum load capacity of the stowage well under the cargo compartment floor is 55 lbs (25 kg).
 - Secure the load with sufficiently strong and wear-resistant tie-downs. Pad sharp edges for protection.
- !** Do not position the load on one part of the folding cargo compartment floor only. The maximum load capacity of the folding cargo compartment floor is 220 lbs (100 kg). Distribute the weight evenly to avoid damaging the cargo compartment floor. Place a solid board under the load if necessary. Please note that the load on the cargo compartment floor will be increased when the load is lashed down.

Stowage areas

Stowage spaces

Important safety notes

WARNING

If you transport objects in the vehicle interior and these are not adequately secured, they could slip or be flung around and thereby strike vehicle occupants. In addition, cup holders, open stowage spaces and mobile phone brackets may not always be able to hold the objects placed in them in the event of an accident. There is a risk of injury, particularly in the event of sharp braking or sudden changes of direction.

- Always stow objects in such a way that they cannot be tossed about in these or similar situations.
- Always make sure that objects do not protrude out of the stowage spaces, luggage nets or stowage nets.
- Ensure that closable stowage spaces are shut before beginning your journey.
- Always stow and secure heavy, hard, pointed, sharp-edged, fragile or large objects in the cargo compartment.

Observe the loading guidelines (▷ page 221).

Stowage compartments in the front

Glove box

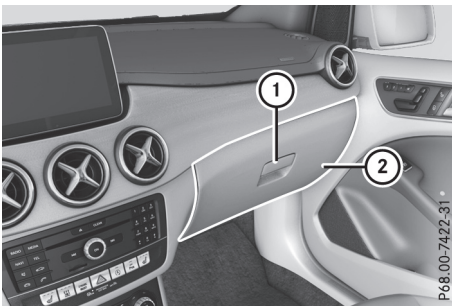

- ▶ **To open:** pull handle ① and open glove box flap ②.
- ▶ **To close:** fold glove box flap ② upwards until it engages.

There is a pen holder at the top of the glove box flap.

Eyeglasses compartment

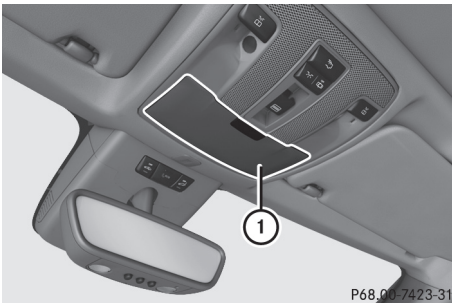

- ▶ **To open:** press marking ①.

Make sure that the eyeglasses compartment is always closed while the vehicle is in motion.

Stowage compartment in the front center console

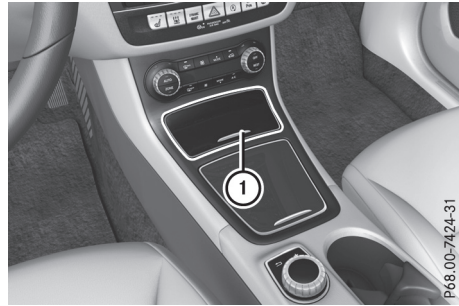

- ▶ **To open:** press the marking on cover ①.

i Depending on the vehicle equipment, there may be an ashtray in the center console instead of a storage compartment.

Stowage compartment in front of the arm-rest (vehicles with automatic transmission)



- ▶ **To open:** press the marking on cover ①.

i You can remove the non-slip mat and the insert for cleaning. When removing the insert you will have to overcome some slight resistance.

Stowage compartment under the armrest

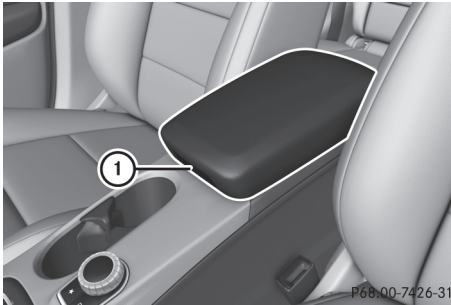

- ▶ **To open:** on vehicles with movable armrests, make sure that the armrest is in the rearmost position.
- ▶ Press button ① and fold the armrest up.

Depending on the vehicle equipment, the armrest can be moved backwards or forwards in a longitudinal direction.

Depending on the vehicle's equipment, the following may be in the stowage compartment: a multimedia connector unit with an SD card slot and 2 USB ports, e.g. for use with an iPod®, iPhone® or MP3 player (see the Digital Operator's Manual).

Stowage spaces in the rear passenger compartment

Stowage compartment in the rear center console

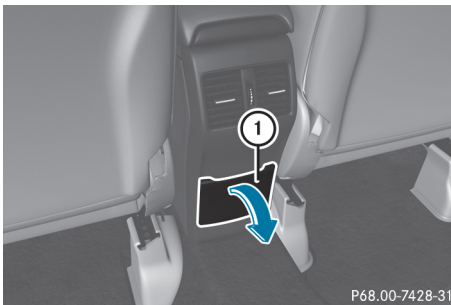

- ▶ **To open:** pull down the top of stowage compartment ① by the edge of the handle.
- ❗ Depending on the vehicle's equipment, there may be an open stowage space above the stowage compartment.

Folding table

⚠ WARNING

If the folding table is folded out while the vehicle is in motion, passengers can be thrown against it, particularly in the event of an accident, heavy braking or a sudden change of direction. There is a risk of injury.

Fold the folding table away before each journey.

- ❗ Do not load the folding table with more than the maximum permissible load of 4.4 lbs (2 kg).



- ▶ **To fold out:** pull folding table ① up in the direction of the arrow to the desired position.
- ▶ **To fold away:** push folding table ① down onto the backrest.

Parcel nets

Stowage nets are located:

- in the front-passenger footwell
- on the back of the driver's and the front-passenger seat

Observe the loading guidelines (▶ page 221) and the safety notes regarding stowage spaces (▶ page 221).

Folding backrest on the front-passenger seat (Canada only)

⚠ WARNING

If the backrest of the front-passenger seat is folded forward, rear seat passengers can come in contact with parts of the seat mech-

anism, particularly in the event of an accident, heavy braking or a sudden change of direction. There is a risk of injury.

If a passenger travels in the vehicle while the front-passenger seat is folded forward, they must sit in the rear seat behind the driver.

The backrest of the front-passenger seat can be folded forwards to increase the cargo compartment capacity.

Once you no longer need the backrest on the front-passenger side to be used as a load surface, fold the backrest back into place.

Stowage and features



- ▶ **To fold forward:** gently push the backrest back.
- ▶ Pull release handle ① and fold the backrest fully onto the seat cushion until it engages.
- ▶ **To fold back:** gently push the backrest down and pull release handle ①.
- ▶ Fold the seat backrest back until it engages.

Through-loading facility in the rear passenger compartment

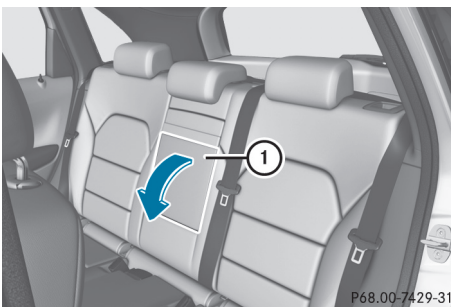

- ▶ **To open:** fold down seat armrest ①.
- ▶ Pull the center head restraint on the rear bench seat into the uppermost position (▷ page 86).

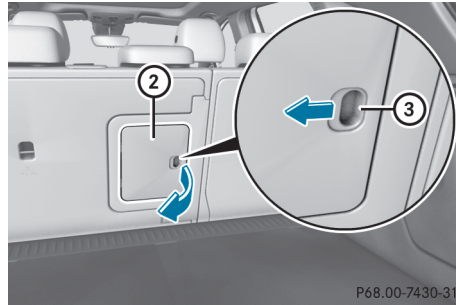

- ▶ Slide locking mechanism ③ in the direction of the arrow.
- ▶ Swing flap ② fully to the side. Flap ② is held open by a magnet.
- ▶ **To close:** swing flap ② in the cargo compartment back until it engages.
- ▶ Fold armrest ① up fully if necessary.

Observe the loading guidelines (▷ page 221).

Cargo compartment enlargement

Important safety notes

⚠ WARNING

If the rear bench seat/rear seat and seat backrest are not engaged they could fold forwards, e.g. when braking suddenly or in the event of an accident.

- The vehicle occupant would thereby be pushed into the seat belt by the rear bench seat/rear seat or by the seat backrest. The seat belt can no longer offer the intended level of protection and could even cause injuries.
- Objects or loads in the trunk/cargo compartment cannot be restrained by the seat backrest.

There is an increased risk of injury.

Before every trip, make sure that the seat backrests and the rear bench seat/rear seat are engaged.

! Before folding the backrest in the rear compartment forwards, make sure that the rear compartment armrest and the cup holder are folded in. They may otherwise be damaged.

Observe the loading guidelines (▷ page 221). The left-hand and right-hand rear seat backrests can be folded forwards separately to increase the cargo compartment capacity.

Vehicles without the EASY-VARIO-PLUS system

Folding the rear seat backrests forward

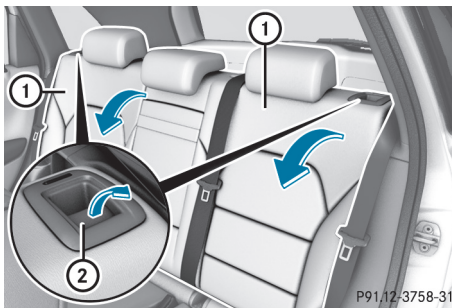

- ▶ Fully insert the backrest head restraints if necessary (▷ page 86).
- ▶ Move the driver's or front-passenger seat forward if necessary.
- ▶ Pull left-hand or right-hand release handle (2) of the seat backrest forward. Corresponding seat backrest (1) is released.
- ▶ Fold backrest (1) forward.
- ▶ Move the driver's or front-passenger seat back if necessary.

Folding the rear seat backrest back

! Make sure that the seat belt does not become trapped when folding the rear seat backrest back. Otherwise, it could be damaged.

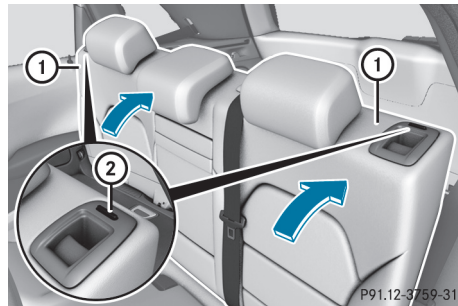

- ▶ Move the driver's or front-passenger seat forward if necessary.
- ▶ Fold seat backrest (1) back until it engages. Red lock status indicator (2) is no longer visible.
- ▶ Adjust the head restraints if necessary (▷ page 86).
- ▶ Move the driver's or front-passenger seat back if necessary.

Vehicles with the EASY-VARIO-PLUS system

Folding the rear seat backrests forward

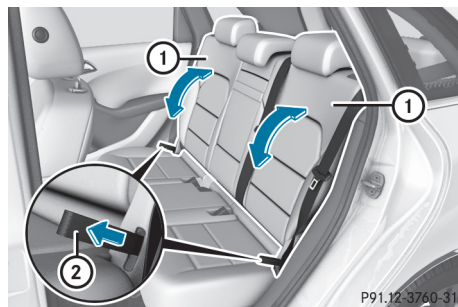

- ▶ Fully insert the backrest head restraints (▷ page 86).
- ▶ Move the rear seat as far back as possible (▷ page 226).
- ▶ Move the driver's or front-passenger seat forward if necessary.
- ▶ Pull right or left loop (2) on the backrest in the direction of the arrow. Corresponding seat backrest (1) is released.
- ▶ Fold down backrest (1) fully.
- ▶ Move the driver's or front-passenger seat back if necessary.

Folding the rear seat backrest back

! Make sure that the seat belt does not become trapped when folding the rear seat backrest back. Otherwise, it could be damaged.

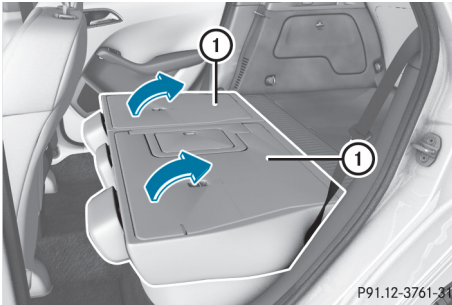

- ▶ Move the driver's or front-passenger seat forward if necessary.
- ▶ Swing backrest ① back.
- ▶ Adjust the backrest to the desired angle by pulling the loop (> page 226).
- ▶ Adjust the head restraints if necessary (> page 86).
- ▶ Move the driver's or front-passenger seat back if necessary.

Notes on using the cargo compartment

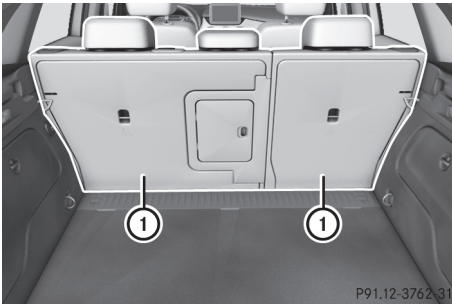

Making the best use of your cargo compartment:

- ▶ Set seat backrest ① to the load position (90° position) (> page 226). The load capacity is increased.
- ▶ Vehicles with a height-adjustable cargo compartment floor: move the cargo compartment floor to the upper position (> page 229). The load surface becomes flat.

- ▶ Move the rear bench seat as far forwards as possible (> page 226). The load area is increased.
- ▶ Fold the rear seat backrest forwards. The load area is lengthened.
- ▶ Fold the folding backrest on the front-passenger seat (> page 223) and the corresponding backrest in the rear forwards. The load area is lengthened.

Adjusting the angle of the rear seat backrests

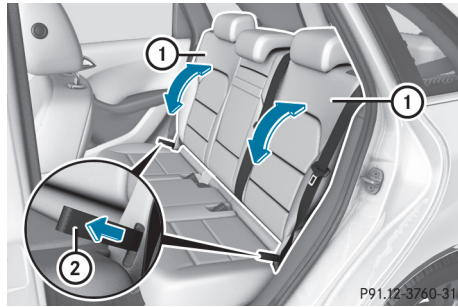

You can set the angle of the seat backrests to one of 13 detent positions.

- ▶ Pull right or left release loop ② forwards in the direction of the arrow. Corresponding seat backrest ① is released.
- ▶ Pull backrest ① forward in the direction of the arrow, or push it back and let it engage.
- ▶ To ensure that the backrest has engaged, lean firmly against backrest ①.

The angle and fore/aft position of the left and right rear seats can be separately adjusted for each seat in order to make better use of the cargo compartment.

Depending on the angle of the backrest, therefore, the right and left rear seats can be pushed back varying distances until the backrest is resting against the cargo compartment cover.

If the backrest comes into contact with surrounding parts of the cargo compartment paneling, reduce the angle of the backrest.

Adjusting the seat fore-and-aft position

! When moving the rear seats back, make sure there are no objects in the footwell or behind the seats. The rear seats and/or the objects could otherwise be damaged.

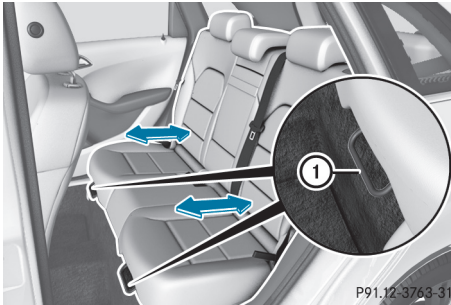

P91.12-3763-31

- ▶ Lift the left or right release handle and slide the corresponding seat forwards or backwards.
- ▶ Let go of the release handle again. Make sure that you hear the seat engage in position.

Securing loads

Cargo tie-down rings

Observe the following notes on securing loads:

- Observe the loading guidelines (▶ page 221).
- Secure the load using the cargo tie-down rings.
- Distribute the load on the cargo tie-down rings evenly.
- Do not use elastic straps or nets to secure a load, as these are only intended as an anti-slip protection for light loads.
- Do not route tie-downs across sharp edges or corners.
- Pad sharp edges for protection.

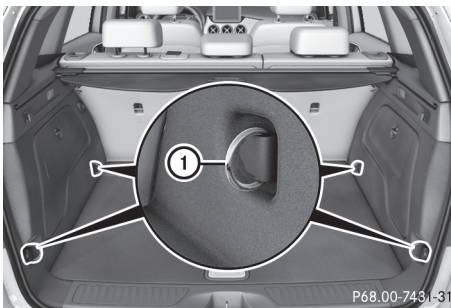

P68.00-7431-31

① Cargo tie-down rings

Bag hook

⚠ WARNING

The bag hooks cannot restrain heavy objects or items of luggage. Objects or items of luggage could be flung around and thereby hit vehicle occupants when braking or abruptly changing directions. There is a risk of injury.

Only hang light objects on the bag hooks. Never hang hard, sharp-edged or fragile objects on the bag hooks.

- ❗ The bag hook can bear a maximum load of 6.6lbs (3kg) and should not be used to secure a load.

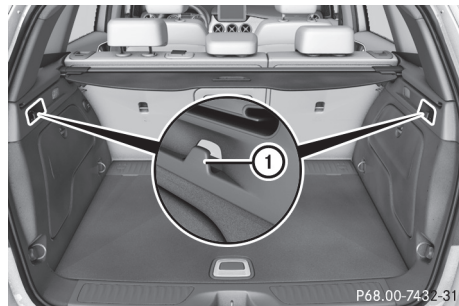

P68.00-7432-31

① Bag hook

Cargo compartment cover

Important safety notes

⚠ WARNING

On its own, the cargo compartment cover cannot secure or restrain heavy objects, items of luggage and heavy loads. You could be hit by an unsecured load during sudden changes in direction, braking or in the event of an accident. There is an increased risk of injury or even fatal injury.

Always store objects so that they cannot be flung around. Secure objects, luggage or loads against slipping or tipping over, e.g. by using tie downs, even if you are using the cargo compartment cover.

- ❗ When loading the vehicle, make sure that you do not stack the load in the cargo com-

partment higher than the lower edge of the side windows. Do not place heavy objects on top of the cargo compartment cover.

- ❗ When removing and installing the cargo compartment cover, ensure that its end caps do not scrape the light-colored parts of the vehicle.

The cargo compartment cover is located behind the rear bench seat backrest.

Extending/retracting the cargo compartment cover

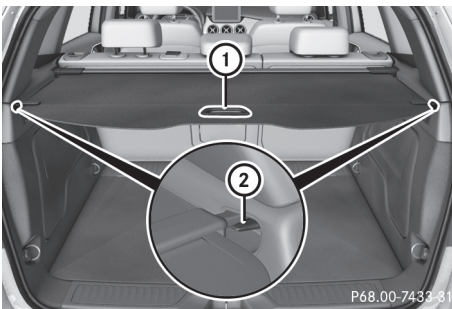

- ▶ **To extend:** pull the cargo compartment cover back by grab handle ① and clip it into retainers ② on the left and right.
- ▶ **To retract:** unhook the cargo compartment cover from retainers ② on the left and right and guide it forwards by grab handle ① until it is fully retracted.

Installing/removing the cargo compartment cover

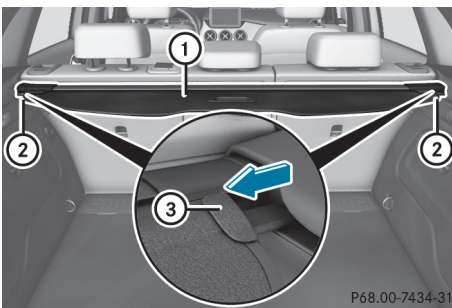

- ▶ **To remove:** make sure that the cargo compartment cover is rolled up.
- ▶ Push in the end cap of cargo compartment cover ① in the direction of the arrow on the

right or left-hand side using grip ③ on the lower edge.

- ▶ Push cargo compartment cover ① into opposite anchorage ②.
- ▶ Remove cargo compartment cover ① upwards.
- ▶ **To install:** set cargo compartment cover ① on the right or left-hand side in anchorage ②.
- ▶ Push in the opposite end cap of cargo compartment cover ① and insert cargo compartment cover ① into opposite anchorage ②.

Stowage well under the cargo compartment floor

Important safety notes

⚠ WARNING

If you drive when the cargo compartment floor is open, objects could be flung around, thus striking vehicle occupants. There is a risk of injury, particularly in the event of sudden braking or a sudden change in direction.

Always close the cargo compartment floor before a journey.

- ❗ The maximum load capacity of the stowage well under the cargo compartment floor is 55 lbs (25 kg).

There is a stowage area for TIREFIT, the vehicle tool kit, a folding box, etc. underneath the cargo compartment floor.

Opening/closing the cargo compartment floor

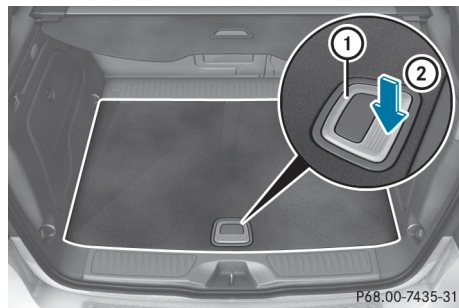

- ▶ **To open:** open the tailgate.
- ▶ Holding ribbing ②, press handle ① downwards. Handle ① folds up.
- ▶ Swing the cargo compartment floor up using handle ① until it rests against the cargo compartment cover.

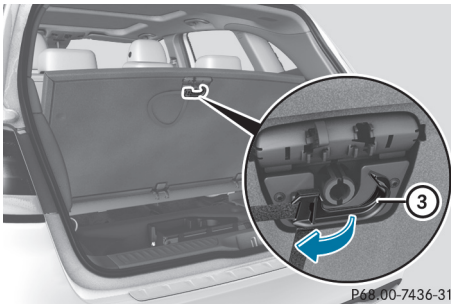

P68.00-7436-31

- ▶ Fold out hook ③ on the underside of the cargo compartment floor.



P68.00-7437-31

- ▶ Attach hook ③ to the cargo compartment's upper seal ④.
- ▶ **To close:** detach hook ③ from upper seal ④.
- ▶ Fasten hook ③ to the bracket on the underside of the cargo compartment floor.
- ▶ Fold the cargo compartment floor down.
- ▶ Press the cargo compartment floor down until it engages.

Setting the height of the cargo compartment floor

The stowage well under the cargo compartment floor can be increased or decreased in size as necessary. To do this, you can lock the floor at two different heights. The upper catch gives a flat load surface when the rear bench seat is folded forward.

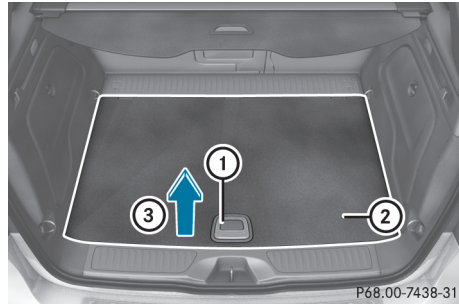

P68.00-7438-31

- ▶ **To raise:** using handle ①, lift up cargo compartment floor ② in the direction of arrow ③ and pull it upwards.
 - ▶ Lower cargo compartment floor ② again. To do this, push the cargo compartment floor away so that it engages in the guide on the upper level. Cargo compartment floor ② engages in the upper position.
- i** Carry out this step using both hands.
- ▶ **To lower:** raise cargo compartment floor ② slightly using handle ① and pull it towards you.
 - ▶ Lower cargo compartment floor ② again slowly. Whilst doing so, press the cargo compartment floor into the lower level. Cargo compartment floor ② engages in the lower position.

Roof carrier

Important safety notes

WARNING

When you load the roof, the center of gravity of the vehicle rises and the driving characteristics change. If you exceed the maximum roof load, the driving characteristics, as well as steering and braking, will be greatly impaired. There is a risk of an accident.

Never exceed the maximum roof load and adjust your driving style.

- ▶ Mercedes-Benz recommends that you only use roof carriers that have been tested and approved for Mercedes-Benz vehicles. This helps to prevent damage to the vehicle.

Position the load on the roof rack in such a way that the vehicle will not sustain damage even when it is in motion.

Ensure that, depending on the vehicle's equipment, you can raise the panorama roof with power tilt/sliding panel fully and open the tailgate fully when the roof carrier is installed.

You will find information on the maximum roof load in the "Technical data" section (▷ page 300).

An incorrectly secured roof carrier or roof load may become detached from the vehicle. You must therefore ensure that you observe the roof carrier manufacturer's installation instructions.

Attaching the roof carrier

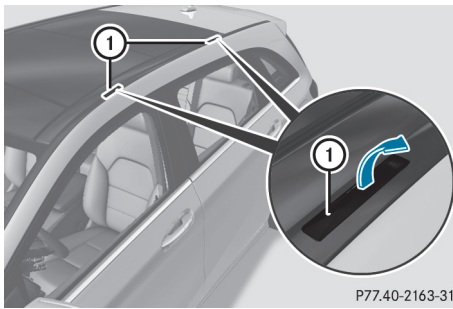

- ▶ Open and fold the covers ① upwards carefully in the direction of the arrow.
- ▶ Only secure the roof carrier to the anchorage points under covers ①.
- ▶ Observe the manufacturer's installation instructions.

Features

Cup holder

Important safety notes

WARNING

The cup holder cannot hold a container secure whilst traveling. If you use a cup holder whilst traveling, the container may be flung around and liquid may be spilled. The vehicle occupants may come into contact with the liquid and if it is hot, they may be scalded. You may

be distracted from the traffic conditions and you could lose control of the vehicle. There is a risk of an accident and injury.

Only use the cup holder when the vehicle is stationary. Only use the cup holder for containers of the right size. Always close the container, particularly if the liquid is hot.

WARNING

The heating elements of the cup holder can become very hot. You could burn yourself on them.

There is a risk of injury.

Do not touch the hot heating elements of the cup holder. Always make sure that children cannot access the hot heating elements of the cup holder. Never leave children unsupervised in the vehicle.

WARNING

If you transport objects in the vehicle interior and these are not adequately secured, they could slip or be flung around and thereby strike vehicle occupants. In addition, cup holders, open stowage spaces and mobile phone brackets may not always be able to hold the objects placed in them in the event of an accident. There is a risk of injury, particularly in the event of sharp braking or sudden changes of direction.

- Always stow objects in such a way that they cannot be tossed about in these or similar situations.
- Always make sure that objects do not protrude out of the stowage spaces, luggage nets or stowage nets.
- Ensure that closable stowage spaces are shut before beginning your journey.
- Always stow and secure heavy, hard, pointed, sharp-edged, fragile or large objects in the cargo compartment.

- ❗ Only use the cup holders for containers of the right size and which have lids. The drinks could otherwise spill.

Observe the loading guidelines (▷ page 221).

The stowage compartments in the doors provide space for bottles:

- front: capacity up to 51 fl. oz. (1.5 l)
- rear: capacity up to 17 fl. oz. (0.5 l)

Cup holder in the front center console

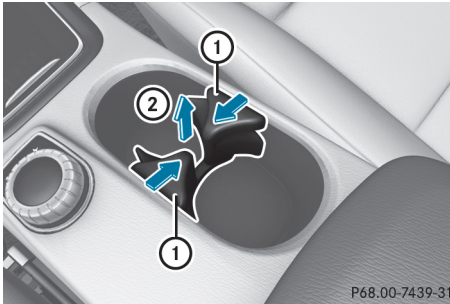

P68.00-7439-31

The cup holder and the rubber mat underneath can be removed for cleaning. Clean them with clean, lukewarm water only.

- ▶ **To remove:** carefully pull in upper sections of cup holder ① on the driver's and front-passenger sides until they release.
- ▶ Lift the cup holder upwards ② until it can be removed.

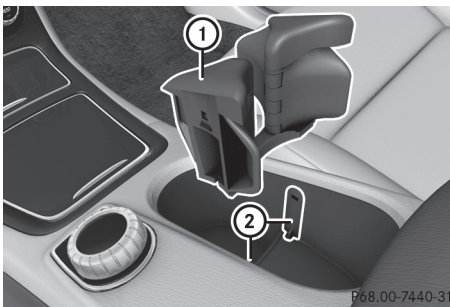

P68.00-7440-31

- ▶ **To install:** insert cup holder into lateral curved sections ② in the stowage compartment. Insert the cup holder so that the wedge of the upper section of cup holder ① faces forwards.
- ▶ Press the cup holder downwards until it engages on the right and left-hand sides.

Cup holder in the rear seat armrest

- ❗ Do not sit on or support your body weight on the rear seat armrest when it is folded down, as you could otherwise damage it.

- ❗ Close the cup holder before folding the rear seat armrest up. Otherwise, the cup holder could be damaged.

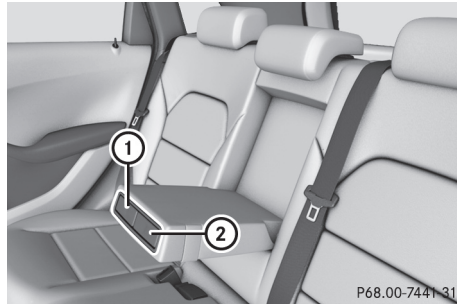

P68.00-7441-31

- ▶ Fold down the rear seat armrest.
- ▶ **To open:** press the front of cup holder ① or ②. Cup holder ① or ② extends automatically.
- ▶ **To close:** slide cup holder ① or ② back until it engages.

Sun visors

Overview

⚠ WARNING

If the mirror cover of the vanity mirror is folded up when the vehicle is in motion, you could be blinded by incident light. There is a risk of an accident.

Always keep the mirror cover folded down while driving.

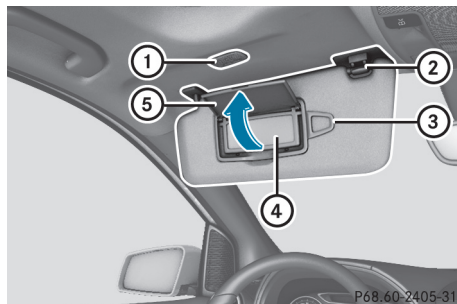

P68.60-2405-31

- ① Mirror light
- ② Bracket
- ③ Retaining clip, e.g. for a car park ticket

- ④ Vanity mirror
- ⑤ Mirror cover

Vanity mirror in the sun visor

Mirror light ① only functions if the sun visor is clipped into bracket ② and mirror cover ⑤ has been folded up.

Glare from the side

- ▶ Fold down the sun visor.
- ▶ Pull the sun visor out of retainer ②.
- ▶ Swing the sun visor to the side.

Stowage and features

Ashtray

Front ashtray

! The stowage space under the ashtray is not heat resistant. Before placing lit cigarettes in the ashtray, make sure that the ashtray is properly engaged. Otherwise, the stowage space could be damaged.

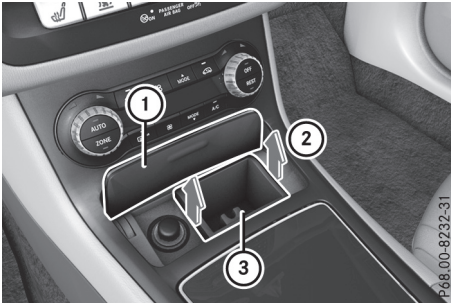

- ▶ **Vehicles with a stowage compartment cover:** press the lower section of cover ①. The stowage compartment opens.
 - ▶ **To remove the insert:** lift insert ③ up ② and out.
 - ▶ **To re-install the insert:** press insert ③ into the holder until it engages.
- i** If you remove the ashtray insert, you can use the resulting compartment for stowage.

Rear compartment ashtray

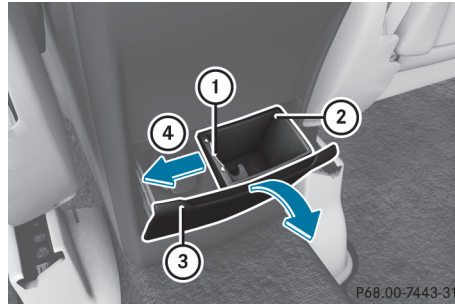

- ▶ **To open:** pull cover ③ out by its top edge.
- ▶ **To remove:** pull insert ② by recess ① in the direction of arrow ④ until it audibly releases.
- ▶ Lift insert ② up and out.
- ▶ **To install the insert:** install insert ② from above into the holder and press down until it engages.

Cigarette lighter

! WARNING

You can burn yourself if you touch the hot heating element or the socket of the cigarette lighter.

In addition, flammable materials can ignite if:

- the hot cigarette lighter falls
- a child holds the hot cigarette lighter to objects, for example

There is a risk of fire and injury.

Always hold the cigarette lighter by the knob. Always make sure that the cigarette lighter is out of reach of children. Never leave children unsupervised in the vehicle.

Your attention must always be focused on the traffic conditions. Only use the cigarette lighter when road and traffic conditions permit.

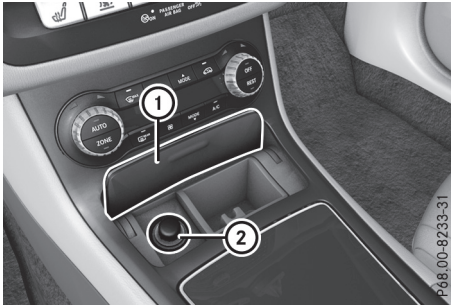

- ▶ Turn the SmartKey to position **2** in the ignition lock (▶ page 114).
- ▶ **Vehicles with a stowage compartment cover:** press the lower section of cover **1**. The stowage compartment opens.
- ▶ Press in cigarette lighter **2**. Cigarette lighter **2** will pop out automatically when the heating element is red-hot.

12 V sockets

General notes

- ▶ Turn the SmartKey to position **1** in the ignition lock (▶ page 114).

The sockets can be used for accessories with a maximum draw of 180 W (15 A). Accessories include such items as chargers for mobile phones.

If you use the sockets for long periods when the engine is switched off, the battery may discharge.

An emergency cut-out ensures that the on-board voltage does not drop too low. If the on-board voltage is too low, the power to the sockets is automatically cut. This ensures that there is sufficient power to start the engine.

Socket in the front center console

- ▶ **Vehicles with a stowage compartment cover:** press the lower section of the cover. The stowage compartment opens.
- ▶ Lift up the cover of the socket.

Socket in the rear compartment center console

- ▶ Pull the cover out by the top of the handle edge.
- ▶ Lift up the cover of the socket.

Socket in the cargo compartment



- ▶ Lift up the cover of socket **1**.

Garage door opener

General notes

The HomeLink® garage door opener integrated in the rear-view mirror allows you to operate up to three different door and gate systems.

Use the integrated garage door opener only on garage doors that:

- have safety stop and reverse features and
- meet current U.S. federal safety standards

Once programmed, the integrated garage door opener in the rear-view mirror will assume the function of the garage door system's remote control. Please also read the operating instructions for the garage door system.

When programming a garage door opener, park the vehicle outside the garage. Do not leave the engine running while programming.

Certain garage door drives are incompatible with the integrated garage door opener. If you have difficulty programming the integrated garage door opener, contact a Mercedes-Benz Service Center.

Alternatively, you can call the following telephone assistance services:

- **USA:** Mercedes-Benz Customer Assistance Center at 1-800-FOR-MERCEdes
- **Canada:** Customer Service at 1-800-387-0100
- HomeLink® hotline 1-800-355-3515 (free of charge)

More information on HomeLink® and/or compatible products is also available online at <http://www.homelink.com>.

Notes on the declaration of conformity (▷ page 26).

USA: FCC ID: CB2HMIHL4

Canada: IC: 279B-HMIHL4

Important safety notes

WARNING

When you operate or program the garage door with the integrated garage door opener, persons in the range of movement of the garage door can become trapped or struck by the garage door. There is a risk of injury.

When using the integrated garage door opener, always make sure that nobody is within the range of movement of the garage door.

WARNING

Combustion engines emit poisonous exhaust gases such as carbon monoxide. Inhaling these exhaust gases leads to poisoning. There is a risk of fatal injury. Therefore never leave the engine running in enclosed spaces without sufficient ventilation.

Programming

Programming the buttons

Pay attention to the "Important safety notes" (▷ page 234).

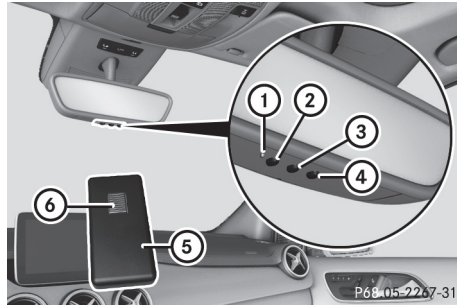

Garage door remote control ⑤ is not included with the integrated garage door opener.

- ▶ Turn the SmartKey to position **2** in the ignition lock (▷ page 114).
- ▶ Select one of buttons ② to ④ to control the garage door drive.
- ▶ **To start program mode:** press and hold one of buttons ② to ④ on the integrated garage door opener.
The garage door opener is now in program mode. After a short time, indicator lamp ① lights up yellow.
Indicator lamp ① lights up yellow as soon as button ②, ③ or ④ is stored for the first time. If the selected button has already been programmed, indicator lamp ① will only light up yellow after ten seconds have elapsed.
- ▶ Release button ②, ③ or ④. Indicator lamp ① flashes yellow.
- ▶ **To program the remote control:** point garage door remote control ⑤ towards buttons ② to ④ on the rear-view mirror at a distance of 2 to 8 in (5 to 20 cm).
- ▶ Press and hold button ⑥ on remote control ⑤ until indicator lamp ① lights up green. When indicator lamp ① lights up green: programming is finished.
When indicator lamp ① flashes green: programming was successful. The next step is to synchronize the rolling code (▷ page 235).
- ▶ Release button ⑥ on remote control ⑤ for the garage door drive system.
If indicator lamp ① lights up red: repeat the programming procedure for the corresponding button on the rear-view mirror. When doing so, vary the distance between remote control ⑤ and the rear-view mirror.

The required distance between remote control ⑤ and the integrated garage door opener depends on the garage door drive system.

Several attempts might be necessary. You should test every position for at least 25 seconds before trying another position.

Synchronizing the rolling code

Pay attention to the "Important safety notes" (▷ page 234).

If the garage door system uses a rolling code, you will also have to synchronize the garage door system with the integrated garage door opener in the rear-view mirror. To do this you will need to use the programming button on the door drive control panel. The programming button may be located in different places depending on the manufacturer. It is usually located on the door drive unit on the garage ceiling.

Familiarize yourself with the garage door drive operating instructions, e.g. under "Programming additional remote controls", before carrying out the following steps.

Your vehicle must be within reach of the garage door or gate opener drive. Make sure that neither your vehicle nor any persons/objects are present within the sweep of the door or gate.

- ▶ Turn the SmartKey to position **2** in the ignition lock (▷ page 114).
- ▶ Get out of the vehicle.
- ▶ Press the programming button on the door drive unit.
Usually, you now have 30 seconds to initiate the next step.
- ▶ Get into the vehicle.
- ▶ Press previously programmed button **②**, **③** or **④** on the integrated garage door opener repeatedly and in quick succession until the door closes.
The rolling code synchronization is then complete.

Notes on programming the remote control

Canadian radio frequency laws require a "break" (or interruption) of the transmission signals after broadcasting for a few seconds. Therefore, these signals may not last long enough for the integrated garage door opener. The signal is not detected during programming. Comparable with Canadian law, some U.S. garage door openers also feature a "break".

Proceed as follows:

- if you live in Canada
- if you have difficulties programming the garage door opener (regardless of where you live) as you follow the programming steps.
- ▶ Press and hold one of buttons **②** to **④** on the integrated garage door opener.
After a short time, indicator lamp **①** lights up yellow.
- ▶ Release the button.
Indicator lamp **①** flashes yellow.
- ▶ Press button **⑥** of garage door remote control **⑤** for two seconds, then release it for two seconds.
- ▶ Press button **⑥** again for two seconds.
- ▶ Repeat this sequence on button **⑥** of remote control **⑤** until indicator lamp **①** lights up green.
When indicator lamp **①** lights up green: programming is finished.
When indicator lamp **①** flashes green: programming was successful. The next step is to synchronize the rolling code.
- ▶ Release button **⑥** of remote control **⑤** of the garage door drive.
If indicator lamp **①** lights up red: repeat the programming process for the corresponding button on the rear-view mirror. When doing so, vary the distance between remote control **⑤** and the rear-view mirror.
The required distance between remote control **⑤** and the integrated garage door opener depends on the garage door drive system. Several attempts might be necessary. You should test every position for at least 25 seconds before trying another position.

Problems when programming

If you are experiencing problems programming the integrated garage door opener on the rear-view mirror, take note of the following instructions:

- Check the transmitter frequency used by garage door drive remote control **⑤** and whether it is supported. The transmitter frequency can usually be found on the back of remote control **⑤** for the garage door drive.
The integrated garage door opener is compatible with devices that have units which

operate in the frequency range of 280 to 433 MHz.

- Replace the batteries in garage door remote control ⑤. This increases the likelihood that garage door remote control ⑤ will transmit a strong and precise signal to the integrated garage door opener.
- When programming, hold remote control ⑤ at varying distances and angles from buttons ② to ④ which you are programming. Try various angles at a distance between 2 and 8 inches (5 to 20 cm) or at the same angle but at varying distances.
- If another remote control ⑤ is available for the same garage door drive, repeat the same programming steps with this remote control ⑤. Before performing these steps, make sure that new batteries have been installed in garage door drive remote control ⑤.
- Note that some remote controls only transmit for a limited amount of time (the indicator lamp on the remote control goes out). Press button ⑥ on remote control ⑤ again before transmission ends.
- Align the antenna cable of the garage door opener unit. This can improve signal reception/transmission.

Opening/closing the garage door

After it has been programmed, the integrated garage door opener performs the function of the garage door system remote control. Please also read the operating instructions for the garage door system.

- ▶ Turn the SmartKey to position **2** in the ignition lock (> page 114).
- ▶ Press button ②, ③ or ④ which you have programmed to operate the garage door.
 - Garage door system with a fixed code: indicator lamp ① lights up green.
 - Garage door system with a rolling code: indicator lamp ① flashes green.

The transmitter will transmit a signal as long as the button is pressed. The transmission is halted after a maximum of ten seconds and indicator lamp ① lights up yellow.
- ▶ Press button ②, ③ or ④ again if necessary.

Clearing the memory

Make sure that you clear the memory of the integrated garage door opener before selling the vehicle.

- ▶ Turn the SmartKey to position **2** in the ignition lock (> page 114).
- ▶ Press and hold buttons ② and ④. The indicator lamp initially lights up yellow and then green.
- ▶ Release buttons ② and ④. The memory of the integrated garage door opener in the rear-view mirror is cleared.

Compass

Calling up the compass

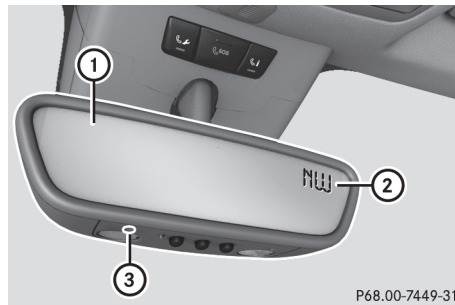

P68.00-7449-31

- ① Rear-view mirror
- ② Compass display
- ③ Opening

The compass displays in which compass direction the vehicle is currently traveling: **N, NE, E, SE, S, SW, W or NW.**

To receive a correct compass display reading, the magnetic field zone must be set and the compass calibrated.

Setting the compass

- ▶ Set your location using the magnetic field zone maps (> page 237).
- ▶ Push a round pen into opening ③ for approximately three seconds. The magnetic field zone currently selected appears in compass display ②.
- ▶ **To select the magnetic field zone:** push a round pen into opening ③ until the desired magnetic field zone is selected. If, after a few seconds, the display in compass display ② changes direction, the magnetic field zone has been selected.

Calibrating the compass

Notes

In order to calibrate the compass correctly, do the following:

- calibrate the compass in the open and not in the vicinity of steel structures or high-voltage transmission lines.
- switch off electrical consumers such as the climate control, windshield wipers or rear window defroster.
- close all doors and the tailgate.

Calibrating

- ▶ Make sure that there is sufficient space for you to drive in a circle without impeding traffic.
- ▶ Switch on the ignition.
- ▶ Push a round pin into opening ③ for approximately six seconds, until symbol C is shown in compass display ②.
- ▶ Drive your vehicle in a full circle at approximately 3 mph (5 km/h) to 6 mph (10 km/h). When the calibration has been successfully completed, the current direction is shown in compass display ②.

Magnetic field zone maps

North America

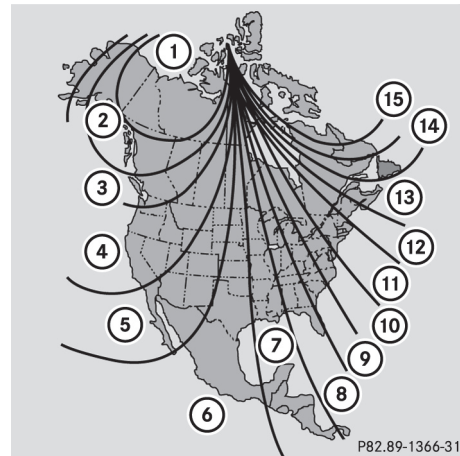

South America

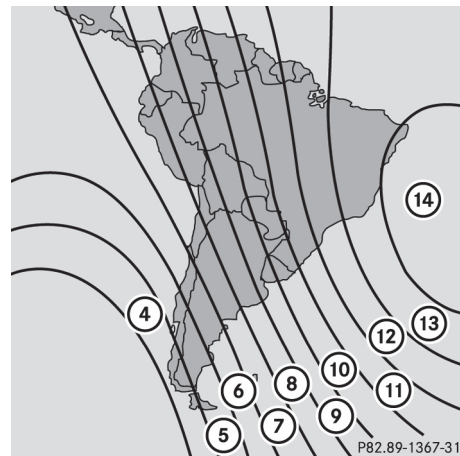

Floormats

⚠ WARNING

Objects in the driver's footwell can restrict the pedal travel or obstruct a depressed pedal. The operating and road safety of the vehicle is jeopardized. There is a risk of an accident.

Make sure that all objects in the vehicle are stowed correctly, and that they cannot enter

the driver's footwell. Install the floormats securely and as specified in order to ensure sufficient clearance for the pedals. Do not use loose floormats and do not place floormats on top of one another.

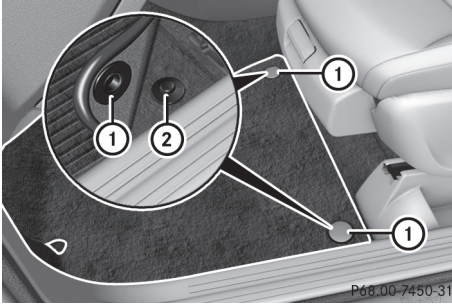

Stowage and features

- ▶ Slide the seat back.
- ▶ **To install:** place the floormat in the footwell.
- ▶ Press safety catch knobs ① onto retainers ②.
- ▶ **To remove:** pull the floormat off retainers ②.
- ▶ Remove the floormat.

Engine compartment

Hood

Important safety notes

WARNING

If the hood is unlatched, it may open up when the vehicle is in motion and block your view. There is a risk of an accident.

Never unlatch the hood while driving. Before every trip, ensure that the hood is locked.

WARNING

When opening and closing the hood, it may suddenly fall into the closed position. There is a risk of injury to persons within range of movement of the hood.

Open and close the hood only when no one is within its range of movement.

WARNING

Opening the hood when the engine is overheated or when there is a fire in the engine compartment could expose you to hot gases or other service products. There is a risk of injury.

Let an overheated engine cool down before opening the hood. If there is a fire in the engine compartment, keep the hood closed and contact the fire department.

WARNING

The engine compartment contains moving components. Certain components, such as the radiator fan, may continue to run or start again suddenly when the ignition is off. There is a risk of injury.

If you need to do any work inside the engine compartment:

- switch off the ignition
- never reach into the area where there is a risk of danger from moving components, such as the fan rotation area

- remove jewelry and watches
- keep items of clothing and hair, for example, away from moving parts

WARNING

The ignition system and the fuel injection system work under high voltage. If you touch components which are under voltage, you could get an electric shock. There is a risk of injury.

Never touch components of the ignition system or fuel injection system when the ignition is switched on.

Opening the hood

WARNING

Certain components in the engine compartment, such as the engine, radiator and parts of the exhaust system, can become very hot. Working in the engine compartment poses a risk of injury.

Where possible, let the engine cool down and touch only the components described in the following.

WARNING

When the hood is open and the windshield wipers are set in motion, you can be injured by the wiper linkage. There is a risk of injury.

Always switch off the windshield wipers and the ignition before opening the hood.

- ❗ Make sure that the windshield wipers are not folded away from the windshield. You could otherwise damage the windshield wipers or the hood.



- ▶ Make sure that the windshield wipers are switched off.
- ▶ Pull release lever ① on the hood. The hood is released.



- ▶ Reach into the gap between the hood and the radiator trim and press hood catch lever ② to the left.
- ▶ Raise the hood.

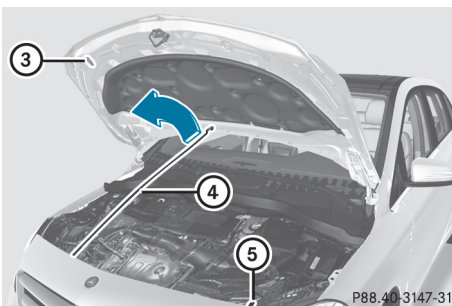

- ▶ Pull support strut ④ out of bracket ⑤.
- ▶ Lift up support strut ④ and insert it into yellow retaining clip ③.

Closing the hood

- ▶ Raise the hood slightly and, at the same time, remove support strut ④ from yellow retaining clip ③.
- ▶ Swing support strut ④ down and press it into bracket ⑤ until it engages.
- ▶ Lower the hood and let it fall from a height of approximately 8 in (20 cm).
- ▶ Check that the hood has engaged properly. If the hood can be raised slightly, it is not properly engaged. Do not press the hood closed. Open the hood again and close it with a little more force.

Engine oil

General notes

Depending on your driving style, the vehicle consumes up to 0.9 US qt (0.8 liters) of oil per 600 miles (1,000 km). The oil consumption may be higher than this when the vehicle is new or if you frequently drive at high engine speeds.

Depending on the engine, the oil dipstick may be in a different location.

When checking the oil level:

- park the vehicle on a level surface
- the engine should be switched off for approximately five minutes if the engine is at normal operating temperature
- if the engine is not at normal operating temperature, e.g. if the engine was only started briefly, wait about 30 minutes before carrying out the measurement

Checking the oil level using the oil dipstick

WARNING

Certain components in the engine compartment, such as the engine, radiator and parts of the exhaust system, can become very hot. Working in the engine compartment poses a risk of injury.

Where possible, let the engine cool down and touch only the components described in the following.

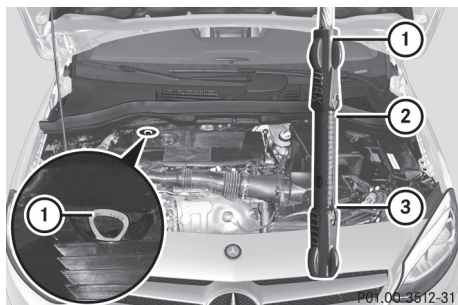

- ▶ Pull oil dipstick ① out of the dipstick guide tube.
- ▶ Wipe off oil dipstick ①.
- ▶ Slowly slide oil dipstick ① into the guide tube to the stop, and take it out again. If the level is between MIN mark ③ and MAX mark ②, the oil level is correct.
- ▶ If the oil level has dropped to MIN mark ③ or below, add 1.1 US qt (1.0 liter) of engine oil.

Adding engine oil

WARNING

Certain components in the engine compartment, such as the engine, radiator and parts of the exhaust system, can become very hot. Working in the engine compartment poses a risk of injury.

Where possible, let the engine cool down and touch only the components described in the following.

WARNING

If engine oil comes into contact with hot components in the engine compartment, it may ignite. There is a risk of fire and injury.

Make sure that engine oil is not spilled next to the filler neck. Let the engine cool down and thoroughly clean the engine oil off the components before starting the engine.

Environmental note

When adding oil, take care not to spill any. If oil enters the soil or waterways, it is harmful to the environment.

! Use only engine oils and oil filters that are approved for vehicles with a service system. A list of the engine oils and oil filters that have been tested and approved in accordance with Mercedes-Benz Specifications for Service Products is available at any authorized Mercedes-Benz Center.

The following cause engine failure or damage to the exhaust system:

- Use of engine oils and oil filters that have not been expressly approved for the service system
- Replacement of engine oil and oil filter after the replacement interval specified by the service system has expired
- Use of engine oil additives

! Do not add too much oil. adding too much engine oil can result in damage to the engine or to the catalytic converter. Have excess engine oil siphoned off.

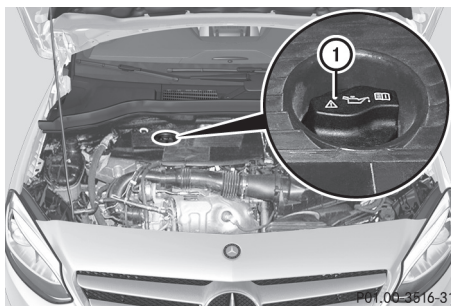

Example: engine oil cap

- ▶ Turn cap ① counter-clockwise and remove it.
- ▶ Add engine oil. If the oil level is at or below the MIN mark on the oil dipstick, add 1.1 US qt (1.0 liter) of engine oil.
- ▶ Replace cap ① on the filler neck and turn clockwise. Ensure that the cap locks into place securely.
- ▶ Check the oil level again with the oil dipstick (▷ page 240).

Further information on engine oil (▷ page 297).

Checking and adding other service products

Checking coolant level

WARNING

The cooling system is pressurized, particularly when the motor is warm. If you open the cap, you could be scalded if hot coolant sprays out. There is a risk of injury.

Let the engine cool down before you open the cap. Wear gloves and eye protection. Slowly open the cap to relieve pressure.

- ! The coolant may only be checked and corrected when the engine is cool (coolant temperature below 104 °F (40 °C)). Checking the coolant when the coolant temperature is above 104 °F (40 °C) may result in damage to the engine or to the engine cooling system.

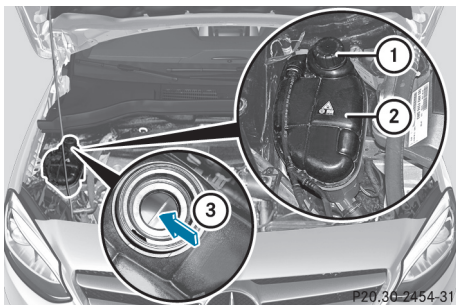

- ▶ Park the vehicle on a level surface. Only check the coolant level when the vehicle is on a level surface and the engine has cooled down.
- ▶ Turn the SmartKey to position **2** in the ignition lock (▷ page 114).
- ▶ Check the coolant temperature display in the instrument cluster. The coolant temperature must be below 104 °F (40 °C).
- ▶ Turn the SmartKey to position **0** (▷ page 114) in the ignition lock.
- ▶ Slowly turn cap **1** counter-clockwise and to relieve excess pressure.
- ▶ Turn cap **1** further counter-clockwise and remove it. If the coolant is at the level of marker bar **3** in the filler neck when cold, there is enough coolant in coolant expansion tank **2**.

- ▶ If necessary, add coolant that has been tested and approved by Mercedes-Benz.
- ▶ Replace cap **1** and turn it clockwise as far as it will go.

For further information on coolant, see (▷ page 298).

Windshield washer system

WARNING

Certain components in the engine compartment, such as the engine, radiator and parts of the exhaust system, can become very hot. Working in the engine compartment poses a risk of injury.

Where possible, let the engine cool down and touch only the components described in the following.

WARNING

Windshield washer concentrate could ignite if it comes into contact with hot engine components or the exhaust system. There is a risk of fire and injury.

Make sure that no windshield washer concentrate is spilled next to the filler neck.

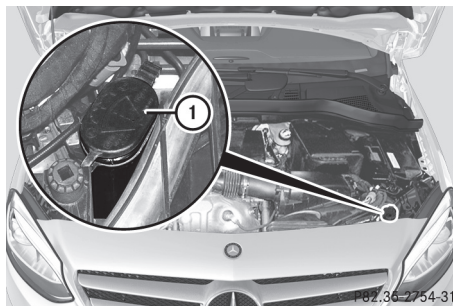

- ▶ **To open:** pull cap **1** upwards by the tab.
- ▶ Add the premixed washer fluid.
- ▶ **To close:** press cap **1** onto the filler neck until it engages.

If the washer fluid level drops below the recommended minimum of 1 liter, a message appears in the multifunction display prompting you to add washer fluid (▷ page 201).

Further information on windshield washer fluid/antifreeze (▷ page 299).

ASSYST PLUS

Service message

The ASSYST PLUS service interval display informs you of the next service due date.

You can find information on the type of service and service intervals in the Maintenance Booklet.

You can obtain further information from an authorized Mercedes-Benz Center or at <http://www.mbusa.com> (USA only).

- i** The ASSYST PLUS service interval display does not show any information on the engine oil level. Observe the notes on the engine oil level (▷ page 240).

The multifunction display shows a service message for several seconds, e.g.:

- Service A in .. days
- Service A due
- Service A overdue by .. days

Depending on the operating conditions of the vehicle, the remaining time or distance until the next service due date is displayed.

The letter **A** or **B**, possibly in connection with a number or another letter, indicates the type of service. **A** stands for a minor service and **B** for a major service.

You can obtain further information from an authorized Mercedes-Benz Center.

The ASSYST PLUS service interval display does not take into account any periods of time during which the battery is disconnected.

Maintaining the time-dependent service schedule:

- ▶ Note down the service due date displayed in the multifunction display before disconnecting the battery.

or

- ▶ After reconnecting the battery, subtract the battery disconnection periods from the service date shown on the display.

Hiding a service message

- ▶ Press the **OK** or **↵** button on the steering wheel.

Displaying service messages

- ▶ Switch on the ignition.
- ▶ Press the **◀** or **▶** button to select the **Service** menu.
- ▶ Press the **▲** or **▼** button to select the **ASSYST PLUS** submenu and confirm by pressing the **OK** button.
The service due date appears in the multifunction display.

Information about Service

Resetting the ASSYST PLUS service interval display

- !** If the ASSYST PLUS service interval display has been inadvertently reset, this setting can be corrected at a qualified specialist workshop.

Have service work carried out as described in the Maintenance Booklet. This may otherwise lead to increased wear and damage to the major assemblies or the vehicle.

A qualified specialist workshop, e.g. an authorized Mercedes-Benz Center, will reset the ASSYST PLUS service interval display after the service work has been carried out. You can also obtain further information on maintenance work, for example.

Special service requirements

The specified maintenance interval takes only the normal operation of the vehicle into account. Under arduous operating conditions or increased load on the vehicle, maintenance work must be carried out more frequently, for example:

- regular city driving with frequent intermediate stops
- if the vehicle is primarily used to travel short distances
- use in mountainous terrain or on poor road surfaces
- if the engine is often left idling for long periods
- in particularly dusty conditions, or if air-recirculation mode is frequently used

In these or similar operating conditions, have the interior filter, engine air cleaner, engine oil and oil filter, for example, changed more fre-

quently. Under arduous operating conditions, the tires must be checked more often. Further information can be obtained at a qualified specialist workshop, e.g. an authorized Mercedes-Benz Center.

Driving abroad

An extensive Mercedes-Benz Service network is also available in other countries. You can obtain further information from any authorized Mercedes-Benz Center.

Care

General notes

Environmental note

Dispose of empty packaging and cleaning cloths in an environmentally responsible manner.

! When cleaning your car, do not use:

- dry, coarse or hard cloths
- abrasive cleaning agents
- solvents
- cleaning agents containing solvents

Do not scrub.

Do not touch the surfaces and films with hard objects, e.g. rings or ice scrapers. Otherwise, you may scratch or damage the surfaces and films.

! Do not park your vehicle for a long period of time directly after cleaning, particularly after cleaning the wheel rim with wheel cleaner. Wheel cleaner can lead to the increased corrosion of the brake discs and pads. Therefore, drive for a few minutes after cleaning. By heating up the brakes, the brake discs and pads dry. The vehicle can then be parked for a long period of time.

Regular care of your vehicle is a condition for retaining the quality in the long term.

Use care products and cleaning agents recommended and approved by Mercedes-Benz.

Washing the vehicle and cleaning the paintwork

Automatic car wash

WARNING

Braking efficiency is reduced after washing the vehicle. There is a risk of an accident.

After the vehicle has been washed, brake carefully while paying attention to the traffic conditions until full braking power is restored.

! When Distance Pilot DISTRONIC or the HOLD function is activated, the vehicle brakes automatically in certain situations. To avoid damage to the vehicle, deactivate Distance Pilot DISTRONIC and the HOLD function in the following or similar situations:

- when towing the vehicle
- in the car wash

! Never clean your vehicle in a Touchless Automatic Car Wash as these use special cleaning agents. These cleaning agents can damage the paintwork or plastic parts.

! Make sure that the automatic transmission is in transmission position **N** when washing your vehicle in a tow-through car wash. The vehicle may be damaged in another transmission position.

! Make sure that:

- the side windows and the sliding sunroof are fully closed.
- the blower is switched off.
- the windshield wiper switch is at position **0**

The vehicle may otherwise be damaged.

You can clean the vehicle in an automatic car wash from the very start.

Preferably, you should wash the vehicle in a car wash that uses fabric washing elements without brushes. This will prevent fine scratches to the paintwork or decorative films.

If the vehicle is very dirty, pre-wash it before cleaning it in an automatic car wash.

After using an automatic car wash, wipe off wax from the windshield and the wiper blades. This will prevent smears and reduce wiping noises caused by residue on the windshield.

- i** Vehicles with decorative films: when using a car wash, choose a wash program without hot wax.

Washing by hand

In some countries, washing by hand is only allowed at specially equipped washing bays. Observe the legal requirements in each country.

- ▶ Do not use hot water and do not wash the vehicle in direct sunlight.
- ▶ Use a soft sponge to clean.
- ▶ Use a mild cleaning agent, such as a car shampoo approved by Mercedes-Benz.
- ▶ Thoroughly hose down the vehicle with a gentle jet of water.
- ▶ Do not point the water jet directly towards the air inlet or the edges of decorative foils.
- ▶ Use plenty of water and rinse out the sponge frequently.
- ▶ Rinse the vehicle with clean water and dry thoroughly with a chamois.
- ▶ Do not let the cleaning agent dry on the paintwork or the decorative foils.

Carefully remove all deposits of road salt as soon as possible when driving in winter.

Power washers

WARNING

The water jet from a circular jet nozzle (dirt blasters) can cause invisible exterior damage to the tires or chassis components. Components damaged in this way may fail unexpectedly. There is a risk of an accident.

Do not use power washers with circular jet nozzles to clean the vehicle. Have damaged tires or chassis components replaced immediately.

- !** Vehicles with decorative foil: parts of your vehicle are covered with decorative foil. Maintain a distance of at least 27.5 in (70 cm) between the foil-wrapped parts of the vehicle and the nozzle of the high pressure cleaner. Information about the correct distance is available from the equipment manufacturer. Move the power washer nozzle around when cleaning your vehicle.

The water temperature of the high-pressure cleaner must not exceed 140 °F (60 °C).

- !** Always maintain a distance of at least 11.8 in (30 cm) between the vehicle and the power washer nozzle. Information about the correct distance is available from the equipment manufacturer.

Move the power washer nozzle around when cleaning your vehicle.

Do not aim directly at any of the following:

- tires
- door gaps, roof gaps, joints, etc.
- electrical components
- battery
- plug-type couplings
- lights
- seals
- trim
- ventilation slots

Damaged seals or electrical components can lead to leaks or failures.

Cleaning the paintwork

- !** Do not affix:
- stickers
 - films
 - magnetic plates or similar items
- to painted surfaces. You could otherwise damage the paintwork.

Scratches, corrosive deposits, areas affected by corrosion and damage caused by inadequate care cannot always be completely repaired. In such cases, visit a qualified specialist workshop.

- ▶ Remove dirt immediately, where possible, while avoiding rubbing too hard.
- ▶ Soak insect remains with insect remover and rinse off the treated areas afterwards.
- ▶ Soak bird droppings with water and rinse off the treated areas afterwards.
- ▶ Remove coolant, brake fluid, tree resin, oils, fuels and greases by rubbing gently with a cloth soaked in petroleum ether or lighter fluid.
- ▶ Use tar remover to remove tar stains.
- ▶ Use silicone remover to remove wax.

If water no longer forms "beads" on the paint surface, use the paint care products recommended and approved by Mercedes-Benz. This is the

case approximately every three to five months, depending on the climate conditions and the care product used.

If dirt has penetrated the paint surface or if the paint has become dull, the paint cleaner recommended and approved by Mercedes-Benz should be used.

Do not use these care products in the sun or on the hood while the hood is hot.

- ▶ Use a suitable touch-up stick, e.g. MB Touch-Up Stick, to repair slight damage to the paintwork quickly and provisionally.

Matte finish care

❗ Never polish the vehicle or the light alloy wheels. Polishing causes the finish to shine.

❗ The following can give the paint a glossy appearance and thus reduce the matt effect:

- Rubbing hard with unsuitable agents
- Washing the vehicle in direct sunlight

❗ Never use paint cleaner, buffing or polishing products, or gloss preserver, e.g. wax, for the purpose of paintwork care. These products are only suitable for high-gloss surfaces. Their use on vehicles with matte paintwork leads to considerable surface damage or, more specifically, to shiny, spotted areas.

Always have paintwork repairs carried out at a qualified specialist workshop.

❗ Only use automatic car washes which correspond to the latest technological standards. Never use wash programs which finish by treating the vehicle with hot wax.

Observe these notes if your vehicle has a clear matte finish. This will help you to avoid damage to the paintwork due to incorrect treatment.

These notes also apply to light alloy wheels with a clear matte finish.

Use only insect remover and car shampoo from the range of approved Mercedes-Benz care products.

Cleaning the decorative film

❗ The following may have an effect on the service life and coloring of decorative film:

- sunlight
- temperature, e.g. hot-air fan
- weather conditions

- stone impacts and dirt
- chemical cleaning agents
- greasy substances

❗ Do not use any types of polish on matt decorative film. Polishing surfaces covered with film gives it a shiny finish.

❗ Do not treat matt or structured decorative film with wax. This may lead to marks that cannot be removed.

Observe the notes in the section on the care and treatment of matte paintwork (> page 246), these notes also apply to matte decorative film.

To clean, use plenty of water and a mild cleaning agent without additional or abrasive products, e.g. a car shampoo approved by Mercedes-Benz.

- ▶ Dry vehicles covered with film using a soft, absorbent cloth after every wash. Water marks could otherwise form.

Scratches, corrosive deposits, areas affected by corrosion and damage caused by inadequate care cannot always be completely repaired. In such cases, visit a qualified specialist workshop.

- ▶ Remove dirt immediately, where possible, while avoiding rubbing too hard. The decorative film may be irreparably damaged.
- ▶ Soak insect remains with insect remover and rinse off the treated areas afterwards.
- ▶ Soak bird droppings with water and rinse off the treated areas afterwards.

The cleaning product, Paint Cleaner, which has been approved and recommended by Mercedes-Benz, should be used when dirt has penetrated the decorative film surface or the decorative film has become dull.

The manufacturer can provide you with information on special care and cleaning products. Laminated surfaces may exhibit optical differences to surfaces which were not protected by a decorative film when the decorative film is removed.

i Have work or repairs on decorative film carried out at a qualified specialist workshop. Mercedes-Benz recommends that you use an authorized Mercedes-Benz Center for this purpose.



Cleaning the vehicle parts

Cleaning the wheels

WARNING

The water jet from a circular jet nozzle (dirt blasters) can cause invisible exterior damage to the tires or chassis components. Components damaged in this way may fail unexpectedly. There is a risk of an accident.

Do not use power washers with circular jet nozzles to clean the vehicle. Have damaged tires or chassis components replaced immediately.



-  Do not use acidic wheel cleaning products to remove brake dust. This could damage wheel bolts and brake components.
-  Do not park your vehicle for a long period of time directly after cleaning, particularly after cleaning the wheel rim with wheel cleaner. Wheel cleaner can lead to the increased corrosion of the brake discs and pads. Therefore, drive for a few minutes after cleaning. By heating up the brakes, the brake discs and pads dry. The vehicle can then be parked for a long period of time.

Cleaning the windows

WARNING

You could become trapped by the windshield wipers if they start moving while cleaning the windshield or wiper blades. There is a risk of injury.

Always switch off the windshield wipers and the ignition before cleaning the windshield or wiper blades.

-  Only fold the windshield wipers away from the windshield when vertical. Otherwise, you will damage the hood.
-  Do not use dry cloths, abrasive products, solvents or cleaning agents containing solvents to clean the inside of the windows. Do not touch the insides of the windows with hard objects, e.g. an ice scraper or ring. There is otherwise a risk of damaging the windows.





-  Clean the water drainage channels of the windshield and the rear window at regular intervals. Deposits such as leaves, petals and pollen may under certain circumstances prevent water from draining away. This can lead to corrosion damage and damage to electronic components.
- ▶ Clean the inside and outside of the windows with a damp cloth and a cleaning product that is recommended and approved by Mercedes-Benz.

Cleaning wiper blades

WARNING

You could become trapped by the windshield wipers if they start moving while cleaning the windshield or wiper blades. There is a risk of injury.

Always switch off the windshield wipers and the ignition before cleaning the windshield or wiper blades.

-  Only fold the windshield wipers away from the windshield when vertical. Otherwise, you will damage the hood.
-  Do not pull the wiper blade. Otherwise, the wiper blade could be damaged.
-  Do not clean wiper blades too often and do not rub them too hard. Otherwise, the graphite coating could be damaged. This could cause wiper noise.
-  Hold the wiper arm securely when folding back. The windshield could be damaged if the wiper arm smacks against it suddenly.
- ▶ Fold the windshield wiper arms away from the windshield.
- ▶ Carefully clean the wiper blades with a damp cloth.
- ▶ Fold the windshield wiper arms back again before switching on the ignition.

Cleaning the exterior lighting

-  Only use cleaning agents or cleaning cloths which are suitable for plastic light lenses. Unsuitable cleaning agents or cleaning cloths could scratch or damage the plastic light lenses.

- ▶ Clean the plastic lenses of the exterior lights with a wet sponge and a mild cleaning agent, e.g. Mercedes-Benz car shampoo or cleaning cloths.

Cleaning the mirror turn signals

- ❗ Only use cleaning agents or cleaning cloths that are suitable for plastic lenses. Unsuitable cleaning agents or cleaning cloths could scratch or damage the plastic lenses of the mirror turn signals.
- ▶ Clean the plastic lenses of the mirror turn signals in the exterior mirror housing using a wet sponge and mild cleaning agent, e.g. Mercedes-Benz car shampoo or cleaning cloths.

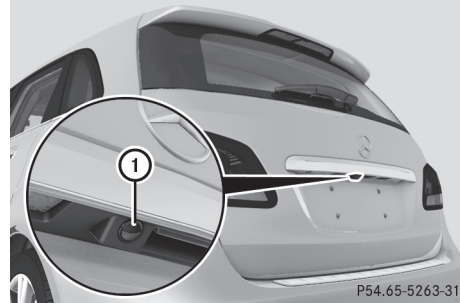

P54.65-5263-31

- ▶ Make sure that the vehicle is at a standstill and the SmartKey is in position **2** in the ignition lock.
- ▶ **To clean the rear view camera:** use clear water and a soft cloth to clean camera lens **1**.

Cleaning the sensors

- ❗ If you clean the sensors with a power washer, make sure that you keep a distance of at least 11.8 in (30 cm) between the vehicle and the power washer nozzle. Information about the correct distance is available from the equipment manufacturer.

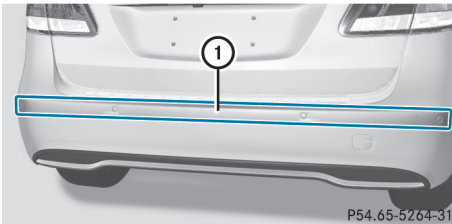
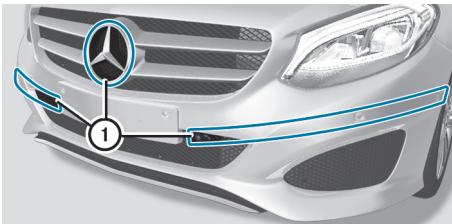

P54.65-5264-31

- ▶ Clean sensors **1** of the driving systems with water, car shampoo and a soft cloth.

Cleaning the rear view camera

- ❗ Do not clean the camera lens and the area around the rear view camera with a power washer.

Cleaning the exhaust pipes

⚠ WARNING

The exhaust tail pipe and tail pipe trim can become very hot. If you come into contact with these parts of the vehicle, you could burn yourself. There is a risk of injury.

Always be particularly careful around the exhaust tail pipe and the tail pipe trim. Allow these components to cool down before touching them.

- ❗ Do not clean the exhaust pipe with acid-based cleaning agents, such as bathroom cleaner or wheel cleaner.
- Impurities combined with the effects of road grit and corrosive environmental factors may cause flash rust to form on the surface. You can restore the original shine of the exhaust pipe by cleaning it regularly, especially in winter and after washing.
- ▶ Clean the exhaust pipe with a care product tested and approved by Mercedes-Benz.

Interior care

Cleaning the display

❗ For cleaning, do not use any of the following:

- alcohol-based thinner or gasoline
- abrasive cleaning agents
- commercially-available household cleaning agents

These may damage the display surface. Do not put pressure on the display surface when cleaning. This could lead to irreparable damage to the display.

- ▶ Before cleaning the display, make sure that it is switched off and has cooled down.
- ▶ Clean the display surface using a commercially available microfiber cloth and TFT/LCD display cleaner.
- ▶ Dry the display surface using a dry microfiber cloth.

Cleaning the plastic trim

WARNING

Care products and cleaning agents containing solvents cause surfaces in the cockpit to become porous. As a result, plastic parts may come loose in the event of air bag deployment. There is a risk of injury.

Do not use any care products and cleaning agents to clean the cockpit.

❗ Never attach the following to plastic surfaces:

- stickers
- films
- perfume oil container or similar

You could otherwise damage the plastic.

❗ Do not allow cosmetics, insect repellent or sunscreen to come into contact with the plastic trim. This maintains the high-quality look of the surfaces.

- ▶ Wipe the plastic trim with a damp, lint-free cloth, e.g. a microfiber cloth.
- ▶ **Heavy soiling:** use care and cleaning products recommended and approved by Mercedes-Benz. The surface may change color temporarily. Wait until the surface is dry again.

Cleaning the steering wheel and gear or selector lever

- ▶ Thoroughly wipe with a damp cloth or use leather care agents that have been recommended and approved by Mercedes-Benz.

Cleaning genuine wood and trim elements

❗ Do not use solvent-based cleaning agents such as tar remover, wheel cleaners, polishes or waxes. There is otherwise a risk of damaging the surface.

❗ Do not use chrome polish on trim pieces. The trim pieces have a chrome look but are mostly made of anodized aluminum and can lose their shine if chrome polish is used. Use a damp, lint-free cloth instead when cleaning the trim pieces. If the chrome-plated trim pieces are very dirty, you can use a chrome polish. If you are unsure as to whether the trim pieces are chrome-plated or not, consult an authorized Mercedes-Benz Center.

- ▶ Wipe the wooden trim and trim pieces with a damp, lint-free cloth, e.g. a microfiber cloth.
- ▶ **Heavy soiling:** use care and cleaning products recommended and approved by Mercedes-Benz.

Cleaning the seat covers

General notes

❗ Do not use a microfiber cloth to clean covers made out of real leather, artificial leather or DINAMICA. If used often, these can damage the cover.

Note that regular care is essential to ensure that the appearance and comfort of the covers is retained over time.

Genuine leather seat covers

! To retain the natural appearance of the leather, observe the following cleaning instructions:

- Clean genuine leather covers carefully with a damp cloth and then wipe the covers down with a dry cloth.
- Make sure that the leather does not become soaked. It may otherwise become rough and cracked.
- Only use leather care agents that have been tested and approved by Mercedes-Benz. You can obtain these from a qualified specialist workshop.

Leather is a natural product.

It exhibits natural surface characteristics, for example:

- differences in the texture
- marks caused by growth and injury
- slight nuances of color

These are characteristics of leather and not material defects.

Seat covers of other materials

! Observe the following when cleaning:

- clean artificial leather covers with a cloth moistened with a solution containing 1% detergent (e.g. dish washing liquid).
- clean cloth covers with a microfiber cloth moistened with a solution containing 1% detergent (e.g. dish washing liquid). Rub carefully and always wipe entire seat sections to avoid leaving visible lines. Leave the seat to dry afterwards. Cleaning results depend on the type of dirt and how long it has been there.
- clean DINAMICA covers with a damp cloth. Make sure that you wipe entire seat sections to avoid leaving visible lines.

Cleaning the seat belts

WARNING

Seat belts can become severely weakened if bleached or dyed. This could cause the seat belts to tear or fail, for instance, in the event of an accident. This poses an increased risk of injury or fatal injury.

Never bleach or dye the seat belts.

! Do not clean the seat belts using chemical cleaning agents. Do not dry the seat belts by heating at temperatures above 176 °F (80 °C) or in direct sunlight.

► Use clean, lukewarm water and soap solution.

Cleaning the headliner and carpets

► **Headliner:** if it is very dirty, use a soft brush or dry shampoo.

► **Carpets:** use the carpet and textile cleaning agents recommended and approved by Mercedes-Benz.

Where will I find...?

Reflective safety jacket

Removing/replacing the reflective safety jacket



The reflective safety jackets are located in front door stowage compartments ①. Reflective safety jackets can also be stored in the rear door stowage compartments.

- ▶ **To remove:** pull out the safety jacket bag containing the reflective safety jacket.
- ▶ Open the safety jacket bag and pull out the reflective safety jacket.
- ▶ **To stow:** fold the reflective safety jacket, roll it up and stow it in the safety jacket bag.
- ▶ Replace the safety jacket bag into stowage compartment ①.

i Remove a new reflective safety jacket from its packaging material before sliding it into the stowage compartment. The packaging material may otherwise cause it to slip out or make removing it difficult.

Observe the legal requirements in each country.

Information on reflective safety jackets

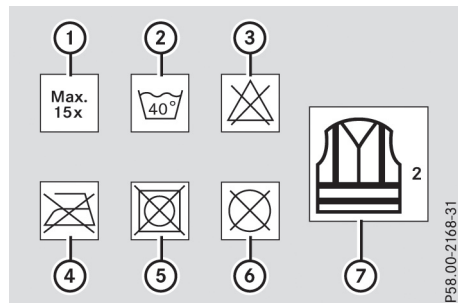

- ① Maximum number of washes
- ② Maximum wash temperature
- ③ Do not bleach
- ④ Do not iron
- ⑤ Do not use a laundry dryer
- ⑥ Do not dry-clean
- ⑦ This is a class 2 vest

- The reflective safety jackets meet the requirements defined by the legal standard only:
 - if the correct size is used and
 - if the reflective safety jackets are correctly fastened
- Before use, ensure that the reflective safety jackets are clean and intact. The special properties may otherwise be compromised.
- The reflective safety jackets should be stored in their original packaging in a dry place away from sources of heat and light.
- The maximum number of washes specified is not the only factor influencing the life span of the reflective safety jackets. Their life span also depends on use, care, storage, etc.
- The reflective safety jackets should be disposed of and replaced with new ones:
 - after 15 washes, and/or
 - if the reflective strips have become scratched, and/or
 - if the backing material and/or reflective strips have become soiled and cannot be cleaned off, and/or
 - if the fluorescence has faded e.g. due to the effects of sunlight
- Dispose of reflective safety jackets in an environmentally responsible manner. To do so, contact your local waste disposal company.

Warning triangle

Removing/replacing the warning triangle

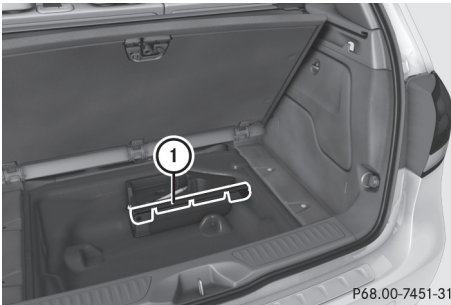

- ▶ **To remove:** open the tailgate.
- ▶ Lift the cargo compartment floor upwards (> page 228).
- ▶ To release warning triangle ①, push back the retainers on the bracket.
- ▶ Remove warning triangle ① from the bracket.
- ▶ **To replace:** place warning triangle ① back into the bracket and push down to secure.
- ▶ Fold the cargo compartment floor down.
- ▶ Close the tailgate.

Setting up the warning triangle

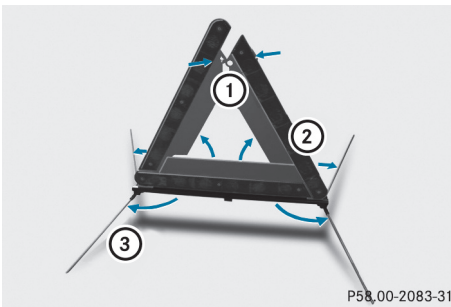

- ▶ Fold feet ③ out to the side.
- ▶ Pull side reflectors ② upwards to form a triangle and lock them at the top using upper press-stud ①.

First-aid kit

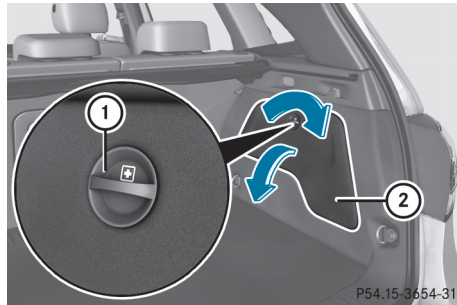

- ▶ Open the tailgate.
- ▶ **To open the stowage compartment:** turn rotary knob ① clockwise and fold down cover ②.



- ▶ Remove first-aid kit ③.

Check the expiration date on the first-aid kit at least once a year. Replace the contents if necessary, and replace missing items.

Vehicle tool kit

General notes

Vehicles with a TIREFIT kit: the TIREFIT kit is located in the stowage well under the cargo compartment floor.

Vehicles with a tire-change tool kit: the tire-change tool kit is in the stowage well under the cargo compartment floor.

Apart from certain country-specific variations, the vehicles are not equipped with a tire-changing tool kit. Some tools for changing a wheel are specific to the vehicle. For more information on which tire changing tools are required and

approved to perform a wheel change on your vehicle, consult a qualified specialist workshop.

Tools required for changing a wheel may include, for example:

- Jack
- Wheel chock
- Lug wrench
- Alignment bolt

Vehicles with a TIREFIT kit

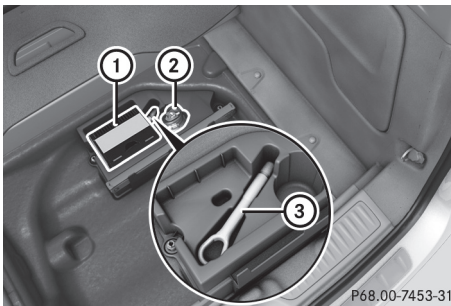

- ① Tire inflation compressor
- ② Tire sealant filler bottle
- ③ Towing eye

- ▶ Open the tailgate.
- ▶ Lift the cargo compartment floor up (> page 228).
- ▶ Use the TIREFIT kit (> page 254) or remove it. Towing eye ③ is located under tire inflation compressor ①.

i Example: equipment and country-specific variations possible.

Vehicles with a tire-change tool kit

- ▶ Open the tailgate.
- ▶ Lift the cargo compartment floor up (> page 228).
- ▶ Remove the tire-change tool kit.

The tire-change tool kit contains:

- Jack
- Lug wrench
- Pair of gloves
- Folding wheel chock

Flat tire

Preparing the vehicle

Your vehicle may be equipped with:

- MOExtended tires (tires with run-flat properties) (> page 254)

Vehicle preparation is not necessary on vehicles with MOExtended tires

- a TIREFIT kit (> page 252)

Vehicles equipped with MOExtended tires are not equipped with a TIREFIT kit at the factory. It is therefore recommended that you additionally equip your vehicle with a TIREFIT kit if you mount tires that do not feature run-flat properties, e.g. winter tires. A TIREFIT kit may be obtained from a qualified specialist workshop.

Information on changing and mounting wheels (> page 286).

- ▶ Stop the vehicle on solid, non-slippery and level ground, as far away as possible from traffic.
- ▶ Switch on the hazard warning lamps.
- ▶ Secure the vehicle against rolling away (> page 129).
- ▶ If possible, bring the front wheels into the straight-ahead position.
- ▶ Switch off the engine.
- ▶ **Vehicles without KEYLESS-GO:** remove the SmartKey from the ignition lock.
- ▶ **Vehicles with KEYLESS-GO start-function or KEYLESS-GO:** open the driver's door. The vehicle electronics are now in position **0**. This is the same as the SmartKey having been removed.
- ▶ **Vehicles with KEYLESS-GO start-function or KEYLESS-GO:** remove the Start/Stop button from the ignition lock (> page 114).
- ▶ Make sure that the engine cannot be started via your smartphone (> page 129).
- ▶ Make sure that the passengers are not endangered as they do so. Make sure that no one is near the danger area while a wheel is being changed. Anyone who is not directly assisting in the wheel change should, for example, stand behind the barrier.
- ▶ Get out of the vehicle. Pay attention to traffic conditions when doing so.
- ▶ Close the driver's door.

MOExtended tires (tires with run-flat properties)

General notes

With MOExtended tires (tires with run flat characteristics), you can continue to drive your vehicle even if there is a total loss of pressure in one or more tires. The affected tire must not show any clearly visible damage.

You can recognize a MOExtended tire by the MOExtended marking which appears on the sidewall of the tire. You will find this marking next to the tire size designation, the load-bearing capacity and the speed index (▷ page 28 1). MOExtended tires may only be used in conjunction with an active tire pressure loss warning system.

If a pressure loss warning message appears in the multifunction display:

- observe the instructions in the display messages (▷ page 198).
- check the tire for damage
- if driving on, observe the following notes

The driving distance possible in run-flat mode is approximately 50 miles (80 km) when the vehicle is partially laden. When the vehicle is fully laden it is approximately 19 miles (30 km).

In addition to the vehicle load, the driving distance possible depends upon:

- vehicle speed
- road condition
- outside temperature

The driving distance possible in run-flat mode may be reduced by extreme driving conditions or maneuvers, or it can be increased through a moderate style of driving.

The driving distance possible in run-flat mode is counted from the moment the tire pressure loss warning appears in the multifunction display.

You must not exceed a maximum speed of 50 mph (80 km/h).

When replacing one or all tires, please observe the following specifications for your vehicle's tires:

- size
- type and
- the "MOExtended" marking

If a tire has gone flat and cannot be replaced with a MOExtended tire, a standard tire may be used as a temporary measure. Make sure that

you use the proper size and type (summer or winter tire).

Vehicles equipped with MOExtended tires are not equipped with a TIREFIT kit at the factory. It is therefore recommended that you additionally equip your vehicle with a TIREFIT kit if you mount tires that do not feature run-flat properties, e.g. winter tires. A TIREFIT kit may be obtained from a qualified specialist workshop.

Important safety notes

WARNING

When driving in emergency mode, the driving characteristics deteriorate, e.g. when cornering, accelerating quickly and when braking. There is a risk of an accident.

Do not exceed the stated maximum speed. Avoid abrupt steering and driving maneuvers, and driving over obstacles (curbs, potholes, off-road). This applies in particular to a laden vehicle.

Stop driving in emergency mode if:

- you hear banging noises.
- the vehicle starts to shake.
- you see smoke and smell rubber.
- ESP® is intervening constantly.
- there are tears in the sidewalls of the tire.

After driving in emergency mode, have the wheel rims checked at a qualified specialist workshop with regard to their further use. The defective tire must be replaced in every case.

TIREFIT kit

Important safety notes

TIREFIT is a tire sealant.

For USA only: You can use TIREFIT to seal punctures of up to 0.16 in (4 mm), particularly those in the tire tread. You can use TIREFIT at outside temperatures down to -4 °F (-20 °C).

⚠ WARNING

In the following situations, the tire sealant is unable to provide sufficient breakdown assistance, as it is unable to seal the tire properly:

- there are cuts or punctures in the tire larger than those mentioned above.
- the wheel rim is damaged.
- you have driven at very low tire pressures or on a flat tire.

There is a risk of an accident.

Do not drive the vehicle. Contact a qualified specialist workshop.

⚠ WARNING

The tire sealant is harmful and causes irritation. It must not come into contact with your skin, eyes or clothing or be swallowed. Do not inhale TIREFIT fumes. Keep tire sealant away from children. There is a risk of injury.

If you come into contact with the tire sealant, observe the following:

- Rinse off the tire sealant from your skin immediately with water.
- If the tire sealant comes into contact with your eyes, immediately rinse them thoroughly with clean water.
- If tire sealant is swallowed, immediately rinse your mouth out thoroughly and drink plenty of water. Do not induce vomiting, and seek medical attention immediately.
- Immediately change out of clothing which has come into contact with tire sealant.
- If an allergic reaction occurs, seek medical attention immediately.

- !** Residue from the tire sealant may come out of the filler hose after use. This could cause stains.

Therefore, place the filler hose in the plastic bag which contained the TIREFIT kit.

♻ Environmental note

Have the used tire sealant bottle disposed of professionally, e.g. at a qualified specialist workshop.

- !** Do not operate the tire inflation compressor for longer than ten minutes at a time without a break. It may otherwise overheat.

The tire inflation compressor can be operated again once it has cooled down.

Comply with the manufacturer's safety instructions on the sticker on the tire inflation compressor.

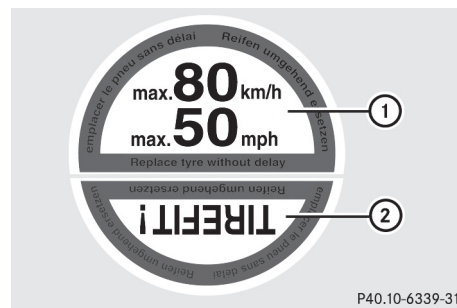
Using the TIREFIT kit

P40.10-6339-31

- ▶ Do not remove any foreign objects which have penetrated the tire, e.g. screws or nails.
- ▶ Remove the tire sealant bottle, the accompanying TIREFIT sticker and the tire inflation compressor from the stowage well underneath the cargo compartment floor (> page 253).
- ▶ Affix part ① of the TIREFIT sticker to the instrument cluster within the driver's field of vision.
- ▶ Affix part ② of the TIREFIT sticker near the valve on the wheel with the defective tire.

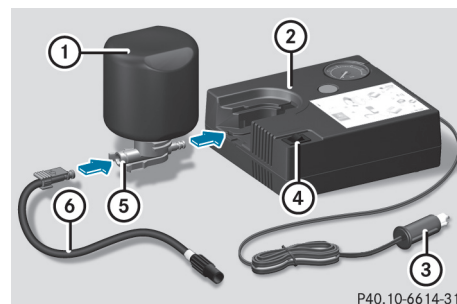

P40.10-6614-31

- ▶ Remove filler hose (6) and connector (3) from the bottom section of the tire inflation compressor housing (2).
- ▶ Slide the yellow filler hose connector into the mounting on yellow cap (5) of tire sealant filler bottle (1) until the connector engages.
- ▶ With the sealing rings in front, slide yellow cap (5) of tire sealant bottle (1) into the mounting of tire inflation compressor (2). Yellow cap (5) and both hooks must engage.

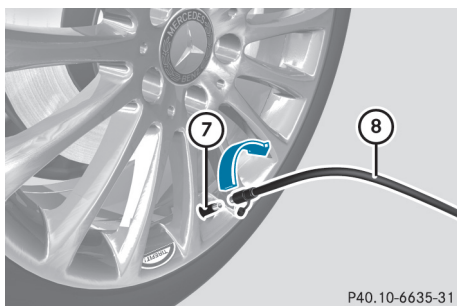

- ▶ Remove the cap from valve (7) on the faulty tire.
- ▶ Screw filler hose (8) onto valve (7).
- ▶ Insert plug (3) into a 12 V socket in your vehicle. Observe the notes on sockets (▷ page 233).
- ▶ Turn the SmartKey to position 1 in the ignition lock (▷ page 114).
- ▶ Press on and off switch (4) on the tire inflation compressor to **ON**. The tire inflation compressor is switched on. The tire is inflated. First, tire sealant is pumped into the tire. The pressure can briefly rise to approximately 500 kPa (5 bar/73 psi). **Do not switch off the tire inflation compressor during this phase.**
- ▶ Let the tire inflation compressor run for a maximum of ten minutes. The tire should then have attained a pressure of at least 200 kPa (2.0 bar/29 psi).

If a pressure of 200 kPa (2.0 bar/29 psi) has been attained after five minutes, see "Tire pressure reached" (▷ page 256).

If a tire pressure of 200 kPa (2.0 bar/29 psi) has not been attained after five minutes, see "Tire pressure not reached" (▷ page 256).

If tire sealant has escaped, clean it off affected areas as quickly as possible. Use plain water if possible.

If your clothes are soiled with tire sealant, have them cleaned with perchloroethylene at a dry cleaner as soon as possible.

Tire pressure not reached

If a tire pressure of 200 kPa (2.0 bar/29 psi) has not been attained after ten minutes:

- ▶ Switch off the tire inflation compressor.
- ▶ Unscrew the filler hose from the valve of the faulty tire. Note that tire sealant may escape when you unscrew the filler hose.
- ▶ **USA only:** very slowly drive forwards or reverse approximately 30 ft (10 m).
- ▶ Pump up the tire again. After a maximum of ten minutes, the tire pressure must be at least 200 kPa (2.0 bar/29 psi).

⚠ WARNING

If the required tire pressure is not reached after the specified time, the tire is too badly damaged. The tire sealant cannot repair the tire in this instance. Damaged tires and a tire pressure that is too low can significantly impair the vehicle's braking and driving characteristics. There is a risk of accident.

Do not continue driving. Contact a qualified specialist workshop.

Tire pressure reached

⚠ WARNING

A tire temporarily sealed with tire sealant impairs the driving characteristics and is not suitable for higher speeds. There is a risk of accident.

You should therefore adapt your driving style accordingly and drive carefully. Do not exceed the specified maximum speed with a tire that has been repaired using tire sealant.

USA only: The maximum permissible speed for a tire sealed with tire sealant is 50 mph (80 km/h). The upper part of the TIREFIT sticker

must be affixed to the instrument cluster in the driver's field of vision.

If a tire pressure of 200 kPa (2.0 bar/29 psi) has been attained after ten minutes:

- ▶ Switch off the tire inflation compressor.
- ▶ Unscrew the filler hose from the valve of the faulty tire.
Note that tire sealant may escape when you unscrew the filler hose.
- ▶ **USA only:** Stow the tire sealant bottle and the tire inflation compressor.
- ▶ **Pull away immediately.**
- ▶ Stop after driving for approximately ten minutes and check the tire pressure with the tire inflation compressor.
The tire pressure must now be at least 130 kPa (1.3 bar/19 psi).

WARNING

If the required tire pressure is not reached after driving for a short period, the tire is too badly damaged. The tire sealant cannot repair the tire in this instance. Damaged tires and a tire pressure that is too low can significantly impair the vehicle's braking and driving characteristics. There is a risk of accident.

Do not continue driving. Contact a qualified specialist workshop.

- ▶ **i USA only:** In cases such as the one mentioned above, contact an authorized Mercedes-Benz Center. Or call 1-800-FOR-MERCEdes (in the USA) or 1-800-387-0100 (in Canada).
- ▶ **USA only:** Correct the tire pressure if it is still at least 130 kPa (1.3 bar/19 psi). See the Tire and Loading Information placard on the driver's side B-pillar or the tire pressure table in the fuel filler flap for values.
- ▶ **To increase the tire pressure:** switch on the tire inflation compressor.

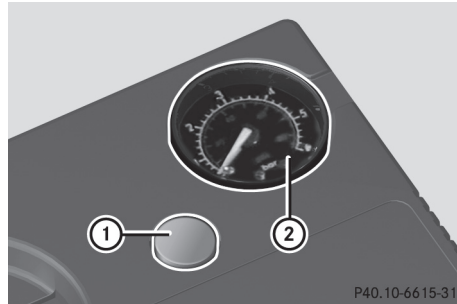

- ▶ **To reduce the tire pressure:** depress pressure release button ① next to pressure gauge ②.
- ▶ When the tire pressure is correct, unscrew the filler hose from the valve of the sealed tire.
Note that tire sealant may escape when you unscrew the filler hose.
- ▶ Screw the valve cap onto the tire valve of the sealed tire.

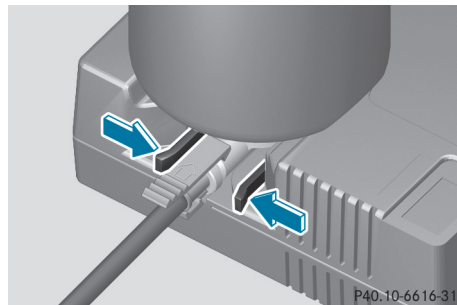

- ▶ To remove the tire sealant bottle from the tire inflation compressor, press together the locking tabs on the yellow cap.
- ▶ Pull the tire sealant bottle out of the tire inflation compressor.
The filler hose remains attached to the tire sealant bottle.
- ▶ Drive to the nearest qualified specialist workshop and have the tire changed there.
- ▶ Have the tire sealant bottle and the filler hose replaced as soon as possible at a qualified specialist workshop.
- ▶ Have the tire sealant bottle replaced every four years at a qualified specialist workshop.

Battery (vehicle)**Important safety notes**

Special tools and expert knowledge are required when working on the battery, e.g. removal and installation. You should therefore have all work involving the battery carried out at a qualified specialist workshop.

⚠ WARNING

Work carried out incorrectly on the battery can lead, for example, to a short circuit and thus damage the vehicle electronics. This can lead to function restrictions applying to safety-relevant systems, e.g. the lighting system, the ABS (anti-lock braking system) or the ESP® (Electronic Stability Program). The operating safety of your vehicle may be restricted. You could lose control of the vehicle, for example:

- when braking
- in the event of abrupt steering maneuvers and/or when the vehicle's speed is not adapted to the road conditions

There is a risk of an accident.

In the event of a short circuit or a similar incident, contact a qualified specialist workshop immediately. Do not drive any further. You should have all work involving the battery carried out at a qualified specialist workshop.

For further information about ABS and ESP®, see (▷ page 57) and (▷ page 60).

⚠ WARNING

Electrostatic build-up can lead to the creation of sparks, which could ignite the highly explosive gases of a battery. There is a risk of an explosion.

Before handling the battery, touch the vehicle body to remove any existing electrostatic build-up.

The highly flammable gas mixture forms when charging the battery as well as when jump-starting.

Always make sure that neither you nor the battery is electrostatically charged. A build-up of electrostatic charge can be caused, for example:

- by wearing clothing made from synthetic fibers
- due to friction between clothing and seats
- if you push or pull the battery across the carpet or other synthetic materials
- if you rub the battery with a cloth

⚠ WARNING

During the charging process, a battery produces hydrogen gas. If a short circuit occurs or sparks are created, the hydrogen gas can ignite. There is a risk of an explosion.

- Make sure that the positive terminal of a connected battery does not come into contact with vehicle parts.
- Never place metal objects or tools on a battery.
- It is important that you observe the described order of the battery terminals when connecting and disconnecting a battery.
- When jump-starting, make sure that the battery poles with identical polarity are connected.
- It is particularly important to observe the described order when connecting and disconnecting the jumper cables.
- Never connect or disconnect the battery terminals while the engine is running.

⚠ WARNING

Battery acid is caustic. There is a risk of injury. Avoid contact with skin, eyes or clothing. Do not inhale any battery gases. Do not lean over the battery. Keep children away from batteries. Wash away battery acid immediately with plenty of clean water and seek medical attention.

**Environmental note**

Batteries contain pollutants. It is illegal to dispose of them with the household rubbish.



They must be collected separately and disposed of in an environmentally responsible recycling system.

Dispose of batteries in an environmentally responsible manner. Take discharged batteries to a qualified specialist workshop or to a collection point for used batteries.

- ❗ Have the battery regularly checked at a qualified specialist workshop.

Comply with the service intervals in the Maintenance Booklet, or contact a qualified specialist workshop for more information.

- ❗ You should have all work involving the battery carried out at a qualified specialist workshop. In the exceptional case that it is necessary for you to disconnect the battery yourself, make sure that:

- switch off the engine and remove the SmartKey. On vehicles with KEYLESS-GO, make sure that the ignition is switched off. Check that all the indicator lamps in the instrument cluster are off. Otherwise, electronic components, such as the alternator, may be damaged.
- you first remove the negative terminal clamp and then the positive terminal clamp. Never swap the terminal clamps. Otherwise, the vehicle's electronic system may be damaged.
- in vehicles with automatic transmission, the transmission is locked in position **P** after the battery is disconnected. The vehicle is secured against rolling away. You can then no longer move the vehicle.

The battery and the cover of the positive terminal clamp must be installed securely during operation.

Comply with safety precautions and take protective measures when handling batteries.



Risk of explosion.



Fire, open flames and smoking are prohibited when handling the battery. Avoid creating sparks.



Battery acid is caustic. Avoid contact with skin, eyes or clothing.

Wear suitable protective clothing, especially gloves, apron and face-guard.

Rinse any acid spills immediately with clear water. Contact a physician if necessary.



Wear eye protection.



Keep children away.



Observe this Operator's Manual.

For safety reasons, Mercedes-Benz recommends that you only use batteries which have been tested and approved for your vehicle by Mercedes-Benz. These batteries provide increased impact protection to prevent vehicle occupants from suffering acid burns should the battery be damaged in the event of an accident. In order for the battery to achieve the maximum possible service life, it must always be sufficiently charged.

Like other batteries, the vehicle battery may discharge over time if you do not use the vehicle. In this case, have the battery disconnected at a qualified specialist workshop. You can also charge the battery with a charger recommended by Mercedes-Benz. Contact a qualified specialist workshop for further information.

Have the battery condition of charge checked more frequently if you use the vehicle mainly for short trips or if you leave it standing idle for a lengthy period. Consult a qualified specialist workshop if you wish to leave your vehicle parked for a long period of time.

Only replace a battery with a battery that has been recommended by Mercedes-Benz.

Remove the SmartKey if you park the vehicle and do not require any electrical consumers. The vehicle will then use very little energy, thus conserving battery power.

If the power supply has been interrupted, e.g. if you reconnect the battery, you will have to:

- set the clock using the multimedia system (see the Digital Operator's Manual)
- reset the function for folding the exterior mirrors in/out automatically, by folding the mirrors out once (▷ page 89)

Charging the battery

WARNING

During charging and jump-starting, explosive gases can escape from the battery. There is a risk of an explosion.

Particularly avoid fire, open flames, creating sparks and smoking. Ensure there is sufficient ventilation while charging and jump-starting. Do not lean over a battery.

WARNING

Battery acid is caustic. There is a risk of injury. Avoid contact with skin, eyes or clothing. Do not inhale any battery gases. Do not lean over the battery. Keep children away from batteries. Wash away battery acid immediately with plenty of clean water and seek medical attention.

WARNING

A discharged battery can freeze at temperatures below freezing point. When jump-start-

ing the vehicle or charging the battery, gases can escape from the battery. There is a risk of an explosion.

Allow the frozen battery to thaw out before charging it or jump-starting.

 Only use battery chargers with a maximum charging voltage of 14.8 V.

 Only charge the battery using the jump-starting connection point.

The jump-starting connection point is in the engine compartment (▷ page 260).

► Open the hood.

► Connect the battery charger to the positive terminal and ground point in the same order as when connecting the donor battery in the jump-starting procedure (▷ page 260).

If the indicator/warning lamps do not light up in the instrument cluster at low temperatures, it is very likely that the discharged battery has frozen. In this case you may neither jump-start the vehicle nor charge the battery. The service life of a thawed-out battery may be shorter. The starting characteristics can be impaired, particularly at low temperatures. Have the thawed-out battery checked at a qualified specialist workshop.

Only charge the installed battery with a battery charger which has been tested and approved by Mercedes-Benz. A battery charger unit specially adapted for Mercedes-Benz vehicles and tested and approved by Mercedes-Benz is available as an accessory. It permits the charging of the battery in its installed position. Contact an authorized Mercedes-Benz Center for further information and availability. Read the battery charger's operating instructions before charging the battery.

Jump-starting

For the jump-starting procedure, use only the jump-starting connection point, consisting of a positive terminal and a ground point, in the engine compartment.

WARNING

Battery acid is caustic. There is a risk of injury.

Avoid contact with skin, eyes or clothing. Do not inhale any battery gases. Do not lean over the battery. Keep children away from batteries. Wash away battery acid immediately with plenty of clean water and seek medical attention.

 **WARNING**

During charging and jump-starting, explosive gases can escape from the battery. There is a risk of an explosion.

Particularly avoid fire, open flames, creating sparks and smoking. Ensure there is sufficient ventilation while charging and jump-starting. Do not lean over a battery.

 **WARNING**

During the charging process, a battery produces hydrogen gas. If a short circuit occurs or sparks are created, the hydrogen gas can ignite. There is a risk of an explosion.

- Make sure that the positive terminal of a connected battery does not come into contact with vehicle parts.
- Never place metal objects or tools on a battery.
- It is important that you observe the described order of the battery terminals when connecting and disconnecting a battery.
- When jump-starting, make sure that the battery poles with identical polarity are connected.
- It is particularly important to observe the described order when connecting and disconnecting the jumper cables.
- Never connect or disconnect the battery terminals while the engine is running.

 **WARNING**

A discharged battery can freeze at temperatures below freezing point. When jump-starting the vehicle or charging the battery, gases can escape from the battery. There is a risk of an explosion. Allow the frozen battery to thaw out before charging it or jump-starting.

! Avoid repeated and lengthy starting attempts. Otherwise, the catalytic converter could be damaged by the non-combusted fuel.

If the indicator/warning lamps do not light up in the instrument cluster at low temperatures, it is very likely that the discharged battery has frozen. In this case you may neither jump-start the vehicle nor charge the battery. Let the battery thaw first. The service life of a thawed-out battery may be shorter. The starting characteristics can be impaired, particularly at low temperatures. Have the thawed-out battery checked at a qualified specialist workshop.

Do not start the vehicle using a rapid charging device. If your vehicle's battery is discharged, the engine can be jump-started from another vehicle or from a second battery using jumper cables. Observe the following points:

- The battery is not accessible in all vehicles. If the other vehicle's battery is not accessible, jump-start the vehicle using a second battery or a jump-starting device.
- You may only jump-start the vehicle when the engine and exhaust system are cold.
- Do not start the engine if the battery is frozen. Let the battery thaw first.
- Only jump-start from batteries with a 12 V voltage rating.
- Only use jumper cables that are not damaged and have a sufficient cross-section and insulated terminal clamps.
- Make sure that the two vehicles do not touch.

Make sure that:

- The jumper cables are not damaged.
- Non-insulated parts of the terminal clamps do not come into contact with other metal parts while the jumper cables are connected to the battery.
- The jumper cables cannot come into contact with parts that can move when the engine is running, such as the V-belt pulley or the fan.
- ▶ Secure the vehicle by applying the electric parking brake.
- ▶ Shift the transmission to position **P**.
- ▶ Turn the SmartKey to position **0** in the ignition lock and remove it.
- ▶ Switch off all electrical consumers, e.g. rear window defroster, lighting, etc.
- ▶ Open the hood.

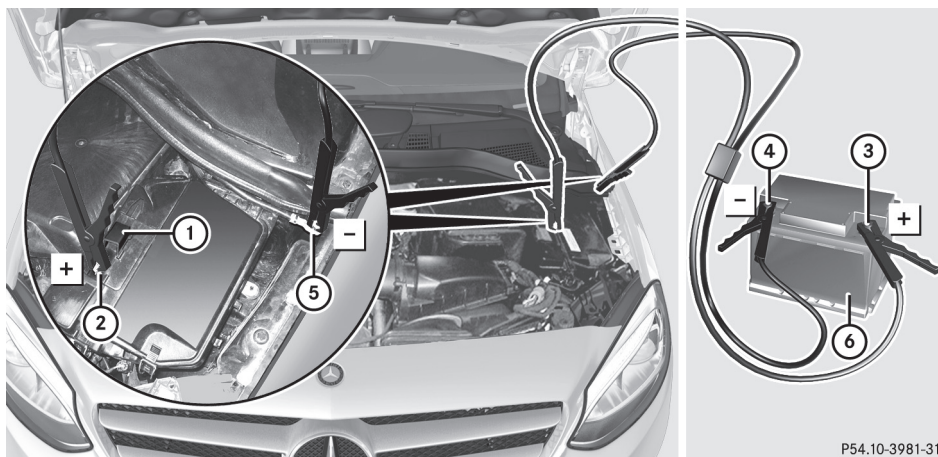

P54.10-3981-31

Position number ⑥ identifies the charged battery of the other vehicle or an equivalent jump-starting device.

- ▶ Press together cover ① of positive clamp ② and slide it back.
- ▶ Connect positive terminal ② on your vehicle to positive terminal ③ of donor battery ⑥ using the jumper cable, beginning with your own battery.
- ▶ Start the engine of the donor vehicle and run it at idling speed.
- ▶ Connect negative terminal ④ of donor battery ⑥ to ground point ⑤ of your vehicle using the jumper cable, connecting the jumper cable to battery of other vehicle ⑥ first.
- ▶ If the battery is fully discharged, leave the battery that is being used to jump-start connected for a few minutes before attempting to start. This charges the battery slightly.
- ▶ Start the engine.
- ▶ Before disconnecting the jumper cables, let the engine run for several minutes.
- ▶ First, remove the jumper cables from ground point ⑤ and negative terminal ④, then from positive terminal ② and positive terminal ③. Begin each time at the contacts on your own vehicle first.
- ▶ Close cover ① of positive terminal ② after removing the jumper cables.
- ▶ Close the hood.
- ▶ Have the battery checked at a qualified specialist workshop.

i Jump-starting is not considered to be a normal operating condition.

i Jumper cables and further information regarding jump-starting can be obtained at any qualified specialist workshop.

Towing and tow-starting

Important safety notes

WARNING

Functions relevant to safety are restricted or no longer available if:

- the engine is not running.
- the brake system or the power steering is malfunctioning.
- there is a malfunction in the voltage supply or the vehicle's electrical system.

If your vehicle is being towed, much more force may be necessary to steer or brake. There is a risk of an accident.

In such cases, use a tow bar. Before towing, make sure that the steering moves freely.

WARNING

You can no longer steer the vehicle if the steering wheel lock has been engaged. There is a risk of an accident.

Always switch off the ignition when towing the vehicle with a tow cable or a tow bar.

WARNING

When towing or tow-starting another vehicle and its weight is greater than the permissible gross weight of your vehicle, the:

- the towing eye could detach itself
- the vehicle/trailer combination could roll-over.

There is a risk of an accident.

When towing or tow-starting another vehicle, its weight should not be greater than the permissible gross weight of your vehicle.

Details on the permissible gross vehicle weight of your vehicle can be found on the vehicle identification plate (▷ page 294).

! When Active Brake Assist, Distance Pilot DISTRONIC or the HOLD function is activated,

the vehicle brakes automatically in certain situations.

To avoid damage to the vehicle, deactivate these systems in the following or similar situations:

- when towing the vehicle
- in the car wash

! Make sure that the electric parking brake is released. If the electric parking brake is faulty, visit a qualified specialist workshop.

! Only secure the tow rope or tow bar at the towing eyes. Otherwise, the vehicle could be damaged.

! Do not use the towing eyes for recovery purposes as this could damage the vehicle. If in doubt, recover the vehicle with a crane.

! When towing, pull away slowly and smoothly. If the tractive power is too high, the vehicles could be damaged.

! The vehicle can be towed a maximum of 30 miles (50km). The towing speed of 30 mph (50km/h) must not be exceeded.

If the vehicle has to be towed more than 30 miles (50km), the front axle must be raised or the entire vehicle raised and transported.

! Do not tow with sling-type equipment. This could damage the vehicle.

! When towing away vehicles with KEYLESS-GO, use the key instead of the Start/Stop button. The automatic transmission may otherwise shift to position **P** when you open the driver's or front-passenger door, which could damage the transmission.

! Vehicles with automatic transmission must not be started by tow-starting. This could otherwise damage the transmission.

It is better to have the vehicle transported than to have it towed away.

If the vehicle can no longer be driven because of an accident or breakdown, you have the following options:

- Transporting the vehicle.

As a rule, you should have the vehicle transported.

- Towing the vehicle with a tow rope or tow bar.

Only tow the vehicle in exceptional cases.

The battery must be connected and charged. Otherwise, you:

- cannot turn the SmartKey to position **2** in the ignition lock.
- cannot release the electric parking brake.
- cannot shift the transmission to position **N**.

The function of the electric parking brake and the parking lock is dependent on the on-board voltage.

If the on-board voltage is low or if there is a system malfunction:

- the electric parking brake may not be applied in certain circumstances, or
- it may no longer be possible to shift the transmission to position **P**

Switch off non-essential consumers, e.g. the radio.

Disarm the automatic locking feature before the vehicle is towed (▷ page 176). You could otherwise be locked out when pushing or towing the vehicle.

Installing/removing the towing eye

Installing the towing eye

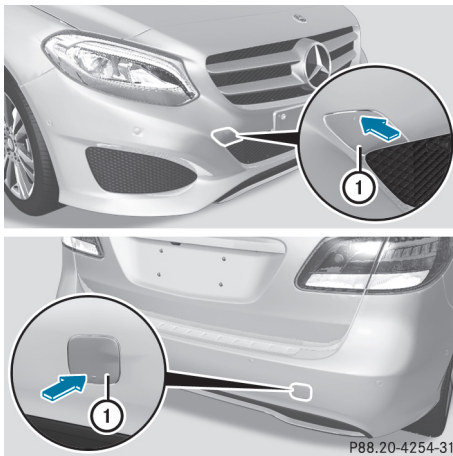

The brackets for the screw-in towing eye are located in the bumpers. They are at the rear and at the front, under covers **1**.

- ▶ Remove the towing eye from the stowage space.

The towing eye is located with the vehicle tool kit under the cargo compartment floor (▷ page 252).

Vehicles with the TIREFIT kit: the towing eye is beneath the tire inflation compressor (▷ page 253).

- ▶ Press the mark on cover **1** inwards in the direction of the arrow.
- ▶ Take cover **1** off the opening.
- ▶ Screw in the towing eye clockwise to the stop.

Removing the towing eye

- ▶ Unscrew and remove the towing eye.
- ▶ Attach cover **1** to the bumper and press until it engages.
- ▶ Place the towing eye in the stowage well beneath the cargo compartment floor in the cargo compartment (▷ page 252).
- ▶ Vehicles with the TIREFIT kit: put back the tire inflation compressor (▷ page 253).

Towing the vehicle with the front axle raised

Observe the important safety notes when towing your vehicle with the front axle raised (▷ page 263).

Only vehicles without 4MATIC can be towed with the front axle raised.

- ❗ Vehicles with 4MATIC must not be towed with either the front or the rear axle raised, as doing so will damage the transmission.

Vehicles with 4MATIC may either be towed away with both axles on the ground or be loaded up and transported.

- ❗ The ignition must be switched off if the vehicle is being towed with the front axle raised. Otherwise, ESP® may intervene and damage the brake system.

- ▶ **On vehicles with KEYLESS-GO or the KEYLESS-GO start function:** you must use the SmartKey instead of the Start/Stop button (▷ page 115).

- ▶ Make sure that the vehicle is stationary.
- ▶ Turn the SmartKey to position **2** in the ignition lock.

- ▶ When the vehicle is stationary, depress the brake pedal and keep it depressed.
- ▶ Shift the automatic transmission to position **P**.
- ▶ Release the brake pedal.
- ▶ Release the electric parking brake.
- ▶ Switch off the automatic locking (▷ page 176).
- ▶ Switch on the hazard warning lamps (▷ page 95).
- ▶ Turn the SmartKey in the ignition lock to position **0** and leave the SmartKey in the ignition lock.

Towing a vehicle with both axles on the ground

It is important that you observe the safety instructions when towing away your vehicle (▷ page 263).

- ▶ **On vehicles with KEYLESS-GO or the KEYLESS-GO start function:** you must use the SmartKey instead of the Start/Stop button (▷ page 115).

The automatic transmission automatically shifts to position **P** when you open the driver's or front-passenger door or when you remove the SmartKey from the ignition lock. In order to ensure that the automatic transmission stays in position **N** when towing away the vehicle, you must observe the following points:

- ▶ Make sure that the vehicle is stationary.
- ▶ Turn the SmartKey to position **2** in the ignition lock.
- ▶ Depress and hold the brake pedal.
- ▶ Shift the automatic transmission to position **N**.
- ▶ Leave the SmartKey in position **2** in the ignition lock.
- ▶ Release the brake pedal.
- ▶ Release the electric parking brake.
- ▶ Switch on the hazard warning lamps (▷ page 95).

i In order to signal a change of direction when towing the vehicle with the hazard warning lamps switched on, use the combination switch as usual. In this case, only the indicator lamps for the direction of travel flash. After

resetting the combination switch, the hazard warning lamp starts flashing again.

Transporting the vehicle

Vehicles with automatic transmission

- ▶ **!** When the vehicle is loaded for transport, the front and rear axles must be stationary and on the same transportation vehicle. Positioning over the connection point of the transport vehicle is not permitted. The drive train may otherwise be damaged.

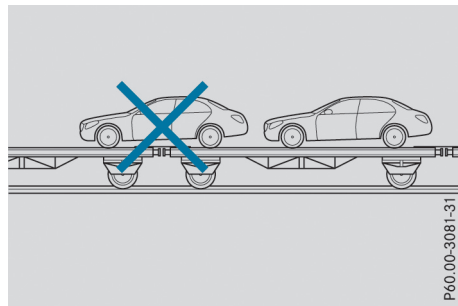

P60.00-3081-31

All vehicles

- ▶ **!** You may only secure the vehicle by the wheels, not by parts of the vehicle such as axle or steering components. Otherwise, the vehicle could be damaged.
- ▶ Turn the SmartKey to position **2** in the ignition lock (▷ page 114).
- ▶ Shift the transmission to position **N**.

As soon as the vehicle has been loaded:

- ▶ Prevent the vehicle from rolling away by applying the electric parking brake.
- ▶ Shift the transmission to position **P**.
- ▶ Turn the SmartKey to position **0** in the ignition lock and remove it.
- ▶ Secure the vehicle.

The towing eye can be used to pull the vehicle onto a trailer or transporter for transporting purposes.

Notes on 4MATIC vehicles

! Vehicles with 4MATIC must not be towed with either the front or the rear axle raised, as doing so will damage the transmission.

Vehicles with 4MATIC may only either be towed away with both axles on the ground or be loaded up and transported.

If the vehicle's transmission, front, or rear axle is damaged, have the vehicle transported on a truck or trailer.

In the event of damage to the electrical system:

If the battery is defective, the automatic transmission will be locked in position **[P]**. To shift the automatic transmission to position **[N]**, you must provide power to the vehicle's on-board electrical system in the same way as when jump-starting (> page 260).

Have the vehicle transported on a transporter or trailer.

Tow-starting (emergency engine starting)

! Vehicles with automatic transmission must not be tow-started. You could otherwise damage the automatic transmission.

i You can find information on "Jump-starting" under (> page 260).

Fuses**Important safety notes****⚠ WARNING**

If you manipulate or bridge a faulty fuse or if you replace it with a fuse with a higher amperage, the electric cables could be overloaded. This could result in a fire. There is a risk of an accident and injury.

Always replace faulty fuses with the specified new fuses having the correct amperage.

! Only use fuses that have been approved for Mercedes-Benz vehicles and which have the correct fuse rating for the system concerned. Only use fuses marked with an "S". Other-

wise, components or systems could be damaged.

! Make sure that no moisture can enter the fuse box when the cover is open.

! When closing the cover, make sure that it is lying correctly on the fuse box. Moisture seeping in or dirt could otherwise impair the operation of the fuses.

The fuses in your vehicle serve to close down faulty circuits. If a fuse blows, all the components on the circuit and their functions stop operating.

Blown fuses must be replaced with fuses of the same rating, which you can recognize by the color and value. The fuse ratings are listed in the fuse allocation chart.

The fuse allocation chart is in the fuse box in the front-passenger footwell (> page 267).

If a newly inserted fuse also blows, have the cause traced and rectified at a qualified specialist workshop, e.g. an authorized Mercedes-Benz Center.

Before changing a fuse

- ▶ Secure the vehicle against rolling away (> page 129).
- ▶ Switch off all electrical consumers.
- ▶ **Vehicles without KEYLESS-GO:** remove the SmartKey from the ignition lock.
- ▶ **Vehicles with KEYLESS-GO start-function or KEYLESS-GO:** open the driver's door. The vehicle electronics are now in position **[0]**. This corresponds to the SmartKey being removed from the ignition.

The fuses are located in various fuse boxes:

- Fuse box in the engine compartment on the left-hand side of the vehicle, when viewed in the direction of travel
- Fuse box in the front-passenger footwell

The fuse allocation chart is on the fuse box in the front-passenger footwell (> page 267).

Fuse box in the engine compartment

WARNING

When the hood is open and the windshield wipers are set in motion, you can be injured by the wiper linkage. There is a risk of injury. Always switch off the windshield wipers and the ignition before opening the hood.

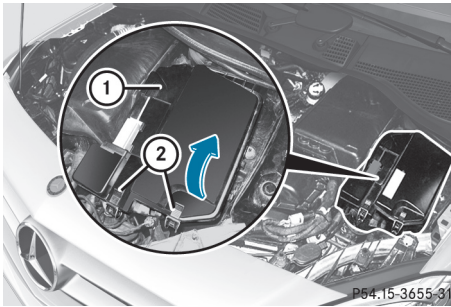

- ▶ Open the hood.
- ▶ Use a dry cloth to remove any moisture from the fuse box.
- ▶ **To open:** open clamps ②.
- ▶ Fold up cover ① in the direction of the arrow and remove it.

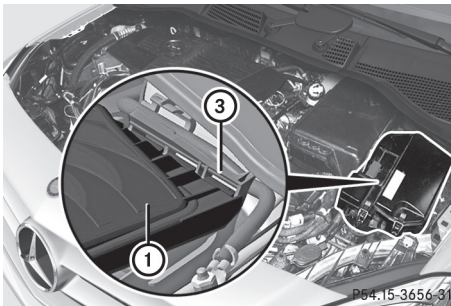

- ▶ **To close:** check whether the seal is lying correctly in cover ①.
- ▶ Insert cover ① at the back into openings ③ on the fuse box.
- ▶ Fold down cover ①.

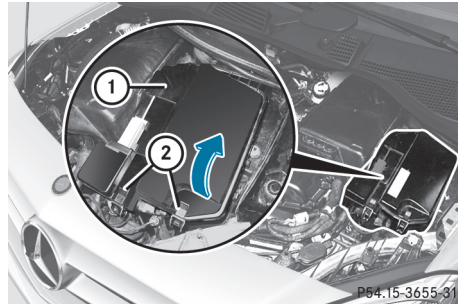

- ▶ Hook clamps ② into the fuse box and close.
- ▶ Close the hood.

Fuse box in the front-passenger footwell

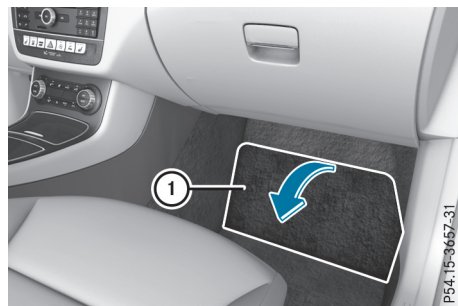

- ▶ **To open:** open the front-passenger door.
- ▶ Remove the floormat.
- ▶ Fold out perforated floor covering ① in the direction of the arrow.

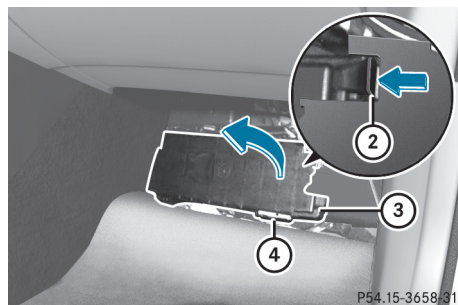

- ▶ To release cover ③, press retaining clamp ②.
- ▶ Fold out cover ③ in the direction of the arrow to the catch.

- ▶ Remove cover ③ forwards.
Fuse allocation chart ④ is located on the lower right-hand side of cover ③.
- ▶ **To close:** insert cover ③ on the left-hand side of the fuse box into the retainer.
Cover ③ engages in the retainers.
- ▶ Fold down cover ③ until clamps ② lock audibly.
- ▶ Fold back perforated floor covering ①.
- ▶ Install the floormats.

Important safety notes

WARNING

If wheels and tires of the wrong size are used, the wheel brakes or suspension components may be damaged. There is a risk of an accident.

Always replace wheels and tires with those that fulfill the specifications of the original part.

When replacing wheels, make sure to use the correct:

- designation
- model

When replacing tires, make sure to use the correct:

- designation
- manufacturer
- model

WARNING

A flat tire severely impairs the driving, steering and braking characteristics of the vehicle. There is a risk of accident.

Tires without run-flat characteristics:

- do not drive with a flat tire.
- immediately replace the flat tire with your emergency spare wheel or spare wheel, or consult a qualified specialist workshop.

Tires with run-flat characteristics:

- pay attention to the information and warning notices on MOExtended tires (tires with run-flat characteristics).

Accessories that are not approved for your vehicle by Mercedes-Benz or are not being used correctly can impair the operating safety.

Before purchasing and using non-approved accessories, visit a qualified specialist workshop and inquire about:

- suitability
- legal stipulations
- factory recommendations

Further information regarding wheels and tires can be found under "Wheel/tire combinations" (> page 290).

You can ask for information regarding permitted wheel/tire combinations at an authorized Mercedes-Benz Center.

Information on tire pressure can be found:

- on the Tire and Loading Information placard on the B-pillar on the driver's side (> page 276)
- in the tire pressure table in the fuel filler flap (> page 127)
- under "Tire pressure" (> page 272)

Operation

Information on driving

Check the tire pressure when the vehicle is heavily laden and adjust prior to a trip.

While driving, pay attention to vibrations, noises and unusual handling characteristics, e.g. pulling to one side. This may indicate that the wheels or tires are damaged. If you suspect that a tire is defective, reduce your speed immediately. Stop the vehicle as soon as possible to check the wheels and tires for damage. Hidden tire damage could also be causing the unusual handling characteristics. If you find no signs of damage, have the tires and wheels checked at a qualified specialist workshop.

When parking your vehicle, make sure that the tires do not get deformed by the curb or other obstacles. If they cannot be avoided, drive over obstacles such as curbs slowly and at an obtuse angle. Otherwise, you may damage the wheels or tires.

Regular checking of wheels and tires

WARNING

Damaged tires can cause tire inflation pressure loss. As a result, you could lose control of your vehicle. There is a risk of accident.

Check the tires regularly for signs of damage and replace any damaged tires immediately.

Check wheels and tires for damage at least once a month. Check wheels and tires after driving off-road or on rough roads. Damaged wheels can cause a loss of tire pressure. Pay particular attention to damage such as:

- Cuts in the tires
- Punctures in the tires
- Tears in the tires
- Bulges on tires
- Deformation or severe corrosion on wheels

Regularly check the tire tread depth and the condition of the tread across the whole width of the tire (▷ page 270). If necessary, turn the front wheels to full lock in order to inspect the inner side of the tire surface.

All wheels must have a valve cap to protect the valve against dirt and moisture. Do not mount anything onto the valve other than the standard valve cap or other valve caps approved by Mercedes-Benz for your vehicle. Do not use any other valve caps or systems, e.g. tire pressure monitoring systems.

Regularly check the pressure of all the tires particularly prior to long trips. Adjust the tire pressure as necessary (▷ page 272).

Observe the notes on the emergency spare wheel (▷ page 290).

The service life of tires depends, among other things, on the following factors:

- Driving style
- Tire pressure
- Distance covered

Notes on tire tread

WARNING

Insufficient tire tread will reduce tire traction. The tire is no longer able to dissipate water. This means that on wet road surfaces, the risk of hydroplaning increases, in particular where speed is not adapted to suit the driving conditions. There is a risk of accident.

If the tire pressure is too high or too low, tires may exhibit different levels of wear at different locations on the tire tread. Thus, you should regularly check the tread depth and the condition of the tread across the entire width of all tires.

Minimum tire tread depth for:

- Summer tires: $\frac{1}{8}$ in (3 mm)
- M+S tires: $\frac{1}{4}$ in (4 mm)

For safety reasons, replace the tires before the legally prescribed limit for the minimum tire tread depth is reached.

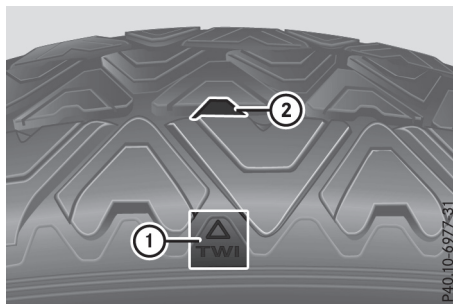

Marking ① shows where bar indicator ② for tread wear is integrated into the tire tread.

Treadwear indicators (TWI) are required by law. Six indicators are positioned on the tire tread. They are visible once a tread depth of approximately $\frac{1}{16}$ in (1.6 mm) has been reached. If this is the case, the tire is so worn that it must be replaced.

Selecting, mounting and replacing tires

WARNING

Exceeding the stated tire load-bearing capacity and the approved maximum speed could lead to tire damage or the tire bursting. There is a risk of accident.

Therefore, only use tire types and sizes approved for your vehicle model. Observe the tire load rating and speed rating required for your vehicle.

- Only mount tires and wheels of the same type and make.
Exception: it is permissible to install a different type or make in the event of a flat tire. Observe here the "MOExtended tires (tires

with run-flat characteristics)" section (▷ page 254).

- Only mount tires of the correct size onto the wheels.
- Break in new tires at moderate speeds for the first 60 miles (100 km). The new tires only reach their full performance after this distance.
- Do not drive with tires which have too little tread depth, as this significantly reduces the traction on wet roads (hydroplaning).
- Replace the tires after six years at the latest, regardless of wear.

Observe the notes on the emergency spare wheel (▷ page 290).

MOExtended tires (tires with run-flat properties)

With MOExtended tires (tires with run flat characteristics), you can continue to drive your vehicle even if there is a total loss of pressure in one or more tires.

MOExtended tires may only be used in conjunction with an active tire pressure loss warning system and only on wheels specifically tested by Mercedes-Benz.

Notes on driving with MOExtended tires with a flat tire (▷ page 254).

Vehicles equipped with MOExtended tires are not equipped with a TIREFIT kit at the factory. It is therefore recommended that you additionally equip your vehicle with a TIREFIT kit if you mount tires that do not feature run-flat properties, e.g. winter tires. A TIREFIT kit may be obtained from a qualified specialist workshop.

Winter operation

General notes

Have your vehicle winter-proofed at a qualified specialist workshop at the onset of winter.

Observe the notes in the "Changing a wheel" section (▷ page 286).

Driving with summer tires

At temperatures below 45 °F (+7 °C), summer tires lose elasticity and therefore traction and

braking power. Change the tires on your vehicle to M+S tires. Using summer tires at very cold temperatures could cause cracks to form, thereby damaging the tires permanently. Mercedes-Benz cannot accept responsibility for this type of damage.

WARNING

Damaged tires can cause tire inflation pressure loss. As a result, you could lose control of your vehicle. There is a risk of accident.

Check the tires regularly for signs of damage and replace any damaged tires immediately.

M+S tires

WARNING

M+S tires with a tire tread depth of less than 1/8 in (4 mm) are not suitable for use in winter and do not provide sufficient traction. There is a risk of an accident.

M+S tires with a tread depth of less than 1/8 in (4 mm) must be replaced immediately.

At temperatures below 45 °F (+7 °C), use winter tires or all-season tires. Both types of tire are identified by the M+S marking.

Only winter tires bearing the  snowflake symbol in addition to the M+S marking provide the best possible grip in wintry road conditions. Only these tires will allow driving safety systems such as ABS and ESP® to function optimally in winter. These tires have been developed specifically for driving in snow.

Use M+S tires of the same make and tread on all wheels to maintain safe handling characteristics.

Always observe the maximum permissible speed specified for the M+S tires you have mounted.

When you have mounted the M+S tires:

- ▶ Check the tire pressures (▷ page 272).
- ▶ Restart the tire pressure loss warning system (Canada) (▷ page 276)

Snow chains**⚠ WARNING**

If snow chains are mounted on the rear wheels, the snow chains could cause abrasion to the vehicle body or to chassis components. This could cause damage to the vehicle or the tires. There is a risk of an accident.

To avoid hazardous situations:

- never mount snow chains on the rear wheels
- only mount snow chains in pairs on the front wheels.

! On some tire sizes there is not enough space for snow chains. To avoid damage to the vehicle or tires, observe the "Wheel and tire combinations" section under "Tires and wheels".

For safety reasons, Mercedes-Benz recommends that you only use snow chains that have been specially approved for your vehicle by Mercedes-Benz, or are of a corresponding standard of quality. For more information, please contact a qualified specialist workshop. If you intend to mount snow chains, please bear the following points in mind:

- Snow chains may not be mounted on all wheel/tire combinations. Permissible wheel-tire combinations (▷ page 290).
- Only use snow chains when driving on roads completely covered by snow. Remove the snow chains as soon as possible when you come to a road that is not snow-covered.
- Local regulations may restrict the use of snow chains. Observe the appropriate regulations if you wish to mount snow chains.
- Do not exceed the maximum permissible speed of 30 mph (50 km/h).
- Never use Parking Pilot when snow chains are installed (▷ page 153).

You may wish to deactivate ESP® when pulling away with snow chains mounted (▷ page 61). You can thereby allow the wheels to spin in a controlled manner, achieving an increased driving force (cutting action).

Information about driving with an emergency spare wheel (▷ page 290).

Tire pressure**Tire pressure specifications****Important safety notes****⚠ WARNING**

Underinflated or overinflated tires pose the following risks:

- the tires may burst, especially as the load and vehicle speed increase.
- the tires may wear excessively and/or unevenly, which may greatly impair tire traction.
- the driving characteristics, as well as steering and braking, may be greatly impaired.

There is a risk of an accident.

Follow recommended tire inflation pressures and check the pressure of all the tires including the spare wheel:

- monthly, at least
- if the load changes
- before beginning a long journey
- under different operating conditions, e.g. off-road driving

If necessary, correct the tire pressure.

i The data on the Tire and Loading Information placard and tire pressure table shown here are examples. Tire pressure specifications are vehicle-specific and may deviate from the data shown here. The tire pressure specifications that are valid for your vehicle can be found on the Tire and Loading Information placard and tire pressure table on the vehicle.

General notes

The recommended tire pressures for the tires mounted at the factory can be found on the labels described here.

Operation with an emergency spare wheel: information on operation with an emergency spare wheel can be found in the general notes in the "Emergency spare wheel" section (▷ page 290).

Further information on tire pressures can be obtained at a qualified specialist workshop.

Tire and Loading Information placard

1 LOADING INFORMATION

TIRE RENSEIGNEMENT SUR LES PNEUS ET LE CHARGEMENT

SEATING CAPACITY / NOMBRE DE PLACES TO 7 | FRONT / AVANT 2 | MIDDLE / MILIEU 3 | REAR / ARRIERE 2

The combined weight of occupants and cargo should never exceed XXX kg or XXX lbs. The combined weight of occupants and cargo should never exceed XXX kg or XXX lbs.

| TIRE PNEU | SIZE DIMENSIONS | COLD TIRE PRESSURE / PRESSION DES PNEUS A FROID | SEE OWNER'S MANUAL FOR ADDITIONAL INFORMATION / VOIR LE MANUEL DE L'USAGER POUR PLUS DE RENSEIGNEMENTS |
|--------------------|---------------------|---|--|
| FRONT / AVANT | 255/40 ZR18 99Y XL | 200 KPA, 29 PSI | |
| REAR / ARRIERE | 285/35 ZR18 101Y XL | 200 KPA, 29 PSI | |
| SPARE / DE SECOURS | 175/55-18 95P | 420 KPA, 60 PSI | |

P40.00-2223-31

1 Recommended tire pressures

The Tire and Loading Information placard is on the B-pillar on the driver's side (▷ page 276).

The Tire and Loading Information placard contains the recommended tire pressures for cold tires. The recommended tire pressures are valid for the maximum permissible load and up to the maximum permissible vehicle speed.

Tire pressure table

The tire pressure table is on the inside of the fuel filler flap. It shows the tire pressure for all tires permitted at the factory for this vehicle; see illustration (example).

COLD TIRE PRESSURE

normal load

maximum load

Warm tires up to: + 4 psi

A 2.12.534-00.15

P40.00-2229-31

The tire pressure table contains the recommended pressures for cold tires for various operating conditions, i.e. differing load and speed conditions.

If a tire size precedes a tire pressure, the following tire pressure information is only valid for that tire size; see illustration (example).

LUFTDRUCK PRESSURE PRESSION PRESSION

für kalte Reifen for cold tires des pneus froids de Inflado

100 kPa = 1 bar

| Tire Size | Normal Load | Maximum Load |
|------------|------------------|------------------|
| 195/55 R16 | 200 kPa / 29 psi | 200 kPa / 29 psi |
| 215/45 R17 | 200 kPa / 29 psi | 200 kPa / 29 psi |
| 215/40 R18 | 200 kPa / 29 psi | 200 kPa / 29 psi |

Warme Reifen: + 30 kPa / + 4 psi | Pneus échauffés jusqu'à: Neumáticos calientes hasta: + 30 kPa / + 4 psi

P40.00-2228-31

The load conditions "partially laden" and "fully laden" are defined in the table for different numbers of occupants and amounts of luggage. The actual number of seats may differ.

Luftdruck für kalte Reifen
Tire pressure cold tires
Pression des pneus froids
Presión de inflado

100 kPa = 1 bar

| Tire Size | Normal Load | Maximum Load |
|-----------|------------------|------------------|
| R18 | 200 kPa / 29 psi | 200 kPa / 29 psi |
| R19 | 200 kPa / 29 psi | 200 kPa / 29 psi |

bis up to 240 km/h / Winterreifen: Winter tires: + 30 kPa / + 4 psi
hasta 150 mph / Presse hiver: Neumáticos de invierno: + 30 kPa / + 4 psi

Warme Reifen bis: Warm tires up to: + 30 kPa / + 4 psi | Pneus échauffés jusqu'à: Neumáticos calientes hasta: + 30 kPa / + 4 psi

A 2.12.534-02.17

P40.00-2230-31

Some tire pressure tables show only the rim diameters instead of the full tire size, e.g. **R18**. Rim diameter is part of the tire size and can be found on the tire sidewall (▷ page 281).

If the tire pressures have been set to the lower values for lighter loads and/or lower road speeds, the pressures should be reset to the higher values:

- if you want to drive with an increased load and/or
- if you want to drive at higher speeds

i The tire pressures for increased loads and/or higher road speeds, shown in the tire pressure table, may have a negative effect on driving comfort.

If the tire pressure is not set correctly, this can lead to an excessive build-up of heat and a sudden loss of pressure.

For more information, contact a qualified specialist workshop.

Important notes on tire pressure **WARNING**

If the tire pressure drops repeatedly, the wheel, valve or tire may be damaged. Tire pressure that is too low may result in a tire blow-out. There is a risk of an accident.

- Check the tire for foreign objects.
- Check whether the wheel is losing air or the valve is leaking.

If you are unable to rectify the damage, contact a qualified specialist workshop.

 **WARNING**

If you fit unsuitable accessories onto tire valves, the tire valves may be overloaded and malfunction, which can cause tire pressure loss. Due to their design, retrofitted tire pressure monitors keep the tire valve open. This can also result in tire pressure loss. There is a risk of an accident.

Only screw the standard valve cap or other valve caps approved by Mercedes-Benz for your vehicle onto the tire valve.

Use a suitable pressure gauge to check the tire pressure. The outer appearance of a tire does not permit any reliable conclusion about the tire pressure. On vehicles equipped with the electronic tire pressure monitor, the tire pressure can be checked in the on-board computer.

The tire temperature and pressure increase when the vehicle is in motion. This is dependent on the driving speed and the load.

Therefore, you should only correct tire pressures when the tires are cold.

The tires are cold:

- if the vehicle has been parked with the tires out of direct sunlight for at least three hours and
- if the vehicle has been driven less than 1 mile (1.6 km)

The tire temperature changes depending on the outside temperature, the vehicle speed and the tire load. If the tire temperature changes by 18 °F (10 °C), the tire pressure changes by approximately 10 kPa (0.1 bar/1.5 psi). Take this into account when checking the pressure of warm tires. Only correct the tire pressure if it is

too low for the current operating conditions. If you check the tire pressure when the tires are warm, the resulting value will be higher than if the tires were cold. This is normal. Do not reduce the tire pressure to the value specified for cold tires. The tire pressure would otherwise be too low.

Observe the recommended tire pressures for cold tires:

- on the Tire and Loading Information placard on the B-pillar on the driver's side
- in the tire pressure table in the fuel filler flap (▷ page 127)

Underinflated or overinflated tires**Underinflated tires** **WARNING**

Tires with pressure that is too low can overheat and burst as a consequence. In addition, they also suffer from excessive and/or irregular wear, which can severely impair the braking properties and the driving characteristics. There is a risk of an accident.

Avoid tire pressures that are too low in all the tires, including the spare wheel.

Underinflated tires may:

- overheat, leading to tire defects
- adversely affect handling
- wear excessively and/or unevenly
- have an adverse effect on fuel consumption

Overinflated tires **WARNING**

Tires with excessively high pressure can burst because they are damaged more easily by road debris, potholes etc. In addition, they also suffer from irregular wear, which can severely impair the braking properties and the driving characteristics. There is a risk of an accident.

Avoid tire pressures that are too high in all the tires, including the spare wheel.

Overinflated tires may:

- increase the braking distance
- adversely affect handling
- wear excessively and/or unevenly
- have an adverse effect on ride comfort
- be more susceptible to damage

Maximum tire pressures

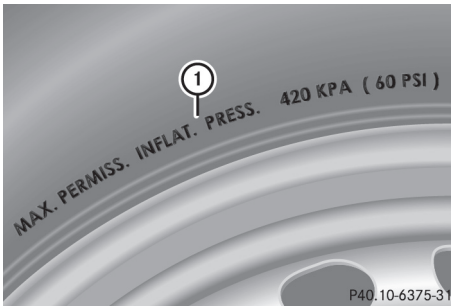

① Example: maximum permissible tire pressure

Never exceed the maximum permissible tire inflation pressure. Always observe the recommended tire pressure for your vehicle when adjusting the tire pressure (▷ page 272).

i The actual values for tires are vehicle-specific and may deviate from the values in the illustration.

Checking the tire pressures

Important safety notes

The tire pressure monitor does not warn you of:

- incorrectly set tire pressure
- sudden loss of tire pressure, e.g. from a foreign object that has penetrated the tire

Observe the notes on tire pressure (▷ page 272).

Information on air pressure for the tires on your vehicle can be found:

- on the vehicle's Tire and Loading Information placard on the B-pillar
- in the tire pressure table in the fuel filler flap (▷ page 127)
- in the "Tire pressure" section

Checking tire pressures manually

To determine and set the correct tire pressure, proceed as follows:

- ▶ Remove the valve cap of the tire that is to be checked.
- ▶ Press the tire pressure gauge securely onto the valve.
- ▶ Read the tire pressure and compare it to the recommended value on the Tire and Loading Information placard or the tire pressure table (▷ page 272).
- ▶ If the tire pressure is too low, increase the tire pressure to the recommended value.
- ▶ If the tire pressure is too high, release air. To do so, press down the metal pin in the valve, using the tip of a pen for example. Then check the tire pressure again using the tire pressure checker.
- ▶ Screw the valve cap onto the valve.
- ▶ Repeat these steps for the other tires.

Tire pressure loss warning system (Canada only)

General notes

While the vehicle is in motion, the tire pressure loss warning system monitors the set tire pressure using the rotational speed of the wheels. This enables the system to detect significant pressure loss in a tire. If the speed of rotation of a wheel changes as a result of a loss of pressure, a corresponding warning message will appear in the multifunction display.

You can recognize the tire pressure loss warning by the **Run Flat Indicator Active Press 'OK' to Restart** message in the multifunction display in the **Serv.** menu. Information on the message display can be found in the "Restarting the tire pressure loss warning" section (▷ page 276).

Important safety notes

The tire pressure warning system does not warn you of an incorrectly set tire pressure. Observe the notes on the recommended tire pressure (▷ page 272).

The tire pressure loss warning does not replace the need to regularly check the tire pressure. An even loss of pressure on several tires at the

same time cannot be detected by the tire pressure loss warning system.







The tire pressure monitor is not able to warn you of a sudden loss of pressure, e.g. if the tire is penetrated by a foreign object. In the event of a sudden loss of pressure, bring the vehicle to a halt by braking carefully. Avoid abrupt steering movements.

The function of the tire pressure loss warning system is limited or delayed if:





- snow chains are mounted on your vehicle's tires.
- road conditions are wintry.
- you are driving on sand or gravel.
- you adopt a very sporty driving style (cornering at high speeds or driving with high rates of acceleration).
- you are driving with a heavy load (in the vehicle or on the roof)

Restarting the tire pressure loss warning system





Restart the tire pressure loss warning system if you have:

- changed the tire pressure
 - changed the wheels or tires
 - mounted new wheels or tires
- ▶ Before restarting, make sure that the tire pressures are set properly on all four tires for the respective operating conditions.
- The recommended tire pressure can be found on the Tire and Loading Information placard on the B-pillar. Additionally, a tire pressure table is attached to the fuel filler flap. The tire pressure loss warning system can only give reliable warnings if you have set the correct tire pressure. If an incorrect tire pressure is set, these incorrect values will be monitored.
- ▶ Also observe the notes in the section on tire pressures (▷ page 272).
 - ▶ Make sure that the SmartKey is in position  in the ignition lock (▷ page 114).
 - ▶ Press  or  on the steering wheel to select the **Serv.** menu.
 - ▶ Press the  or  button to select **Tire Pressure**.
 - ▶ Press the  button. The **Run Flat Indicator Active Press 'OK' to Restart** message appears in the multifunction display.

If you wish to confirm the restart:

- ▶ Press the  button. The **Tire Pressure Now OK?** message appears in the multifunction display.
- ▶ Press the  or  button to select **Yes**.
- ▶ Press the  button. The **Run Flat Indicator Restarted** message appears in the multifunction display. After a teach-in period, the tire pressure loss warning system will monitor the set tire pressures of all four tires.

If you wish to cancel the restart:

- ▶ Press the  button.
- or
- ▶ If the **Tire Pressure Now OK?** message appears, press the  or  button to select **Cancel**.
 - ▶ Press the  button. The tire pressure values stored at the last restart will continue to be monitored.

Loading the vehicle

Instruction labels for tires and loads

WARNING

Overloaded tires can overheat, causing a blowout. Overloaded tires can also impair the steering and driving characteristics and lead to brake failure. There is a risk of accident.

Observe the load rating of the tires. The load rating must be at least half of the GAWR of your vehicle. Never overload the tires by exceeding the maximum load.

Two instruction labels on your vehicle show the maximum possible load.

- (1) The Tire and Loading Information placard is on the B-pillar on the driver's side. The Tire and Loading Information placard shows the maximum permissible number of occupants and the maximum permissible vehicle load. It also contains details of the tire sizes and corresponding pressures for tires mounted at the factory.
- (2) The vehicle identification plate is on the B-pillar on the driver's side. The vehicle identification plate informs you of the gross vehicle weight rating. It is made up of the

vehicle weight, all vehicle occupants, the fuel and the cargo. You can also find information about the maximum gross axle weight rating on the front and rear axle.

The maximum gross axle weight rating is the maximum weight that can be carried by one axle (front or rear axle). Never exceed the maximum load or the maximum gross axle weight rating for the front or rear axle.

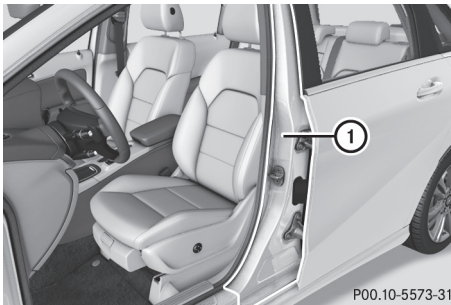

① B-pillar, driver's side

Maximum permissible gross vehicle weight rating

The combined weight of occupants and cargo should never exceed XXX kg or XXX lbs.*
Le poids total des occupants et du chargement ne doit jamais dépasser XXX kg ou XXX lbs.*

| TIRE PNEU | SIZE DIMENSIONS | COLD TIRE PRESSURE PRESSION DES PNEUS A FROID | SEE OWNER'S MANUAL FOR ADDITIONAL INFORMATION |
|------------------|---------------------|---|--|
| FRONT AVANT | 255/40 ZR18 99Y XL | 200 KPA, 29 PSI | VOIR LE MANUEL DE L'USAGER POUR PLUS DE RENSEIGNEMENTS |
| REAR ARRIERE | 285/35 ZR18 101Y XL | 200 KPA, 29 PSI | |
| SPARE DE SECOURS | 175/55-18 95P | 420 KPA, 60 PSI | |

P40.00-2224-31

- Specification for maximum gross vehicle weight ① is listed in the Tire and Loading Information placard: "The combined weight of occupants and cargo should never exceed XXX kilograms or XXX lbs."

The gross weight of all vehicle occupants, load and luggage must not exceed the specified value.

- ① The specifications shown on the Tire and Loading Information placard in the illustration are examples. The maximum permissible gross vehicle weight rating is vehicle-specific and may differ from that in the illustration.

You can find the valid maximum permissible gross vehicle weight rating for your vehicle on the Tire and Loading Information placard.

Number of seats

The combined weight of occupants and cargo should never exceed XXX kg or XXX lbs.*
Le poids total des occupants et du chargement ne doit jamais dépasser XXX kg ou XXX lbs.*

| TIRE PNEU | SIZE DIMENSIONS | COLD TIRE PRESSURE PRESSION DES PNEUS A FROID | SEE OWNER'S MANUAL FOR ADDITIONAL INFORMATION |
|------------------|---------------------|---|--|
| FRONT AVANT | 255/40 ZR18 99Y XL | 200 KPA, 29 PSI | VOIR LE MANUEL DE L'USAGER POUR PLUS DE RENSEIGNEMENTS |
| REAR ARRIERE | 285/35 ZR18 101Y XL | 200 KPA, 29 PSI | |
| SPARE DE SECOURS | 175/55-18 95P | 420 KPA, 60 PSI | |

P40.00-2225-31

Maximum number of seats ① indicates the maximum number of occupants allowed to travel in the vehicle. This information can be found on the Tire and Loading Information placard.

- ① The specifications shown on the Tire and Loading Information placard in the illustration are examples. The number of seats is vehicle-specific and can differ from the details shown. The number of seats in your vehicle can be found on the Tire and Loading Information placard.

Determining the correct load limit

Step-by-step instructions

The following steps have been developed as required of all manufacturers under Title 49, Code of U.S. Federal Regulations, Part 575 pursuant to the "National Traffic and Motor Vehicle Safety Act of 1966".

- **Step 1:** Locate the statement "The combined weight of occupants and cargo should never exceed XXX kg or XXX lbs." on your vehicle's Tire and Loading Information placard.
- **Step 2:** Determine the combined weight of the driver and passengers that will be riding in your vehicle.
- **Step 3:** Subtract the combined weight of the driver and passengers from XXX kilograms or XXX lbs.

- ▶ **Step 4:** The resulting figure equals the available amount of cargo and luggage load capacity. For example, if the "XXX" amount equals 1400 lbs and there will be five 150-lb passengers in your vehicle, the amount of available cargo and luggage load capacity is 650 lbs ($1400 - 750 (5 \times 150) = 650$ lbs).
- ▶ **Step 5:** Determine the combined weight of luggage and cargo being loaded on the vehicle. That weight may not safely exceed the available cargo and luggage load capacity calculated in step 4.

Example: steps 1 to 3

The following table shows examples on how to calculate total and cargo load capacities with varying seating configurations and number and size of occupants. The following examples use a load limit of 1500 lbs (680 kg). **This is for illustration purposes only.** Make sure you are using the actual load limit for your vehicle stated on your vehicle's Tire and Loading Information placard (▷ page 276).

The greater the combined weight of the occupants, the lower the maximum luggage load.

Step 1

| | Example 1 | Example 2 | Example 3 |
|--|-------------------|-------------------|-------------------|
| Combined maximum weight of occupants and cargo (data from the Tire and Loading Information placard) | 1500 lbs (680 kg) | 1500 lbs (680 kg) | 1500 lbs (680 kg) |

Step 2

| | Example 1 | Example 2 | Example 3 |
|---|---|---|-----------------------------|
| Number of people in the vehicle (driver and occupants) | 5 | 3 | 1 |
| Distribution of the occupants | Front: 2 Rear: 3 | Front: 1 Rear: 2 | Front: 1 |
| Weight of the occupants | Occupant 1: 150 lbs (68 kg) Occupant 2: 180 lbs (82 kg) Occupant 3: 160 lbs (73 kg) Occupant 4: 140 lbs (63 kg) Occupant 5: 120 lbs (54 kg) | Occupant 1: 200 lbs (91 kg) Occupant 2: 190 lbs (86 kg) Occupant 3: 150 lbs (68 kg) | Occupant 1: 150 lbs (68 kg) |
| Gross weight of all occupants | 750 lbs (340 kg) | 540 lbs (245 kg) | 150 lbs (68 kg) |

Step 3

| | Example 1 | Example 2 | Example 3 |
|---|---|--|---|
| Permissible load (maximum gross vehicle weight rating from the Tire and Loading Information placard minus the gross weight of all occupants) | 1500 lbs (680 kg) - 750 lbs (340 kg) = 750 lbs (340 kg) | 1500 lbs (680 kg) - 540 lbs (245 kg) = =960 lbs (435 kg) | 1500 lbs (680 kg) - 150 lbs (68 kg) = 1350 lbs (612 kg) |

Vehicle identification plate

Even if you have calculated the total cargo carefully, you should still make sure that the gross vehicle weight rating and the gross axle weight rating are not exceeded. Details can be found on the vehicle identification plate on the B-pillar on the driver's side of the vehicle (> page 276).

Permissible Gross Vehicle Weight Rating (GVWR): the gross weight of the vehicle, all passengers, load and trailer load/noseweight (if applicable) must not exceed the permissible gross vehicle weight.

Gross Axle Weight Rating (GAWR): the maximum permissible weight that can be carried by one axle (front or rear axle).

To ensure that your vehicle does not exceed the maximum permissible values (gross vehicle weight and maximum gross axle weight rating), have your loaded vehicle (including driver, occupants, cargo, and full trailer load if applicable) weighed on a suitable vehicle weighbridge.

All about wheels and tires

Uniform Tire Quality Grading Standards

Overview of Tire Quality Grading Standards

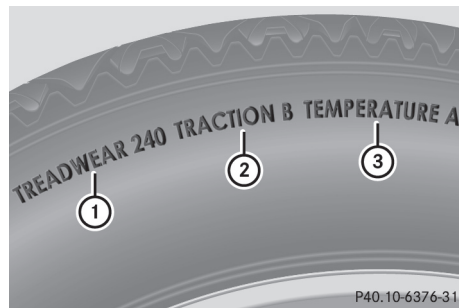

Uniform Tire Quality Grading Standards are U.S. government specifications. Their purpose is to provide drivers with uniform reliable information on tire performance data. Tire manufacturers have to grade tires using three performance factors: ① tread wear grade, ② traction grade and ③ temperature grade. These regulations do not apply to Canada. Nevertheless, all tires sold in North America are provided with the corresponding quality grading markings on the sidewall of the tire.

Quality grades can be found, where applicable, on the tire sidewall between tread shoulder and maximum section width.

Example:

- **Treadwear grade:** 200
- **Traction grade:** AA
- **Temperature grade:** A

All passenger car tires must conform to the statutory safety requirements in addition to these grades.

- i** The actual values for tires are vehicle-specific and may deviate from the values in the illustration.

Treadwear

The treadwear grade is a comparative rating based on the wear rate of the tire when tested under controlled conditions on a specified U.S. government course. For example, a tire graded 150 would wear one and one-half times as well on the government course as a tire graded 100. The relative performance of tires depends upon the actual conditions of their use, however, and may depart significantly from the norm due to variations in driving habits, service practices and differences in road characteristics and climate.

Traction

WARNING

The traction grade assigned to this tire is based on straight-ahead braking traction tests, and does not include acceleration, cornering, hydroplaning, or peak traction characteristics.

- !** Avoid wheelspin. This can lead to damage to the drive train.

The traction grades – from highest to lowest – are AA, A, B and C. Those grades represent the tire's ability to stop on wet pavement as measured under controlled conditions on specified government test surfaces of asphalt and concrete. A tire marked C may have poor traction performance.

The safe speed on a wet, snow covered or icy road is always lower than on dry road surfaces. You should pay special attention to road conditions when temperatures are around freezing point.

Mercedes-Benz recommends a minimum tread depth of $\frac{1}{8}$ in (4 mm) on all four winter tires. Observe the legally required minimum tire tread depth (> page 270). Winter tires can reduce the braking distance on snow-covered surfaces in comparison with summer tires. The braking distance is still much further than on surfaces that

are not icy or covered with snow. Take appropriate care when driving.

Further information on winter tires (M+S tires) (> page 271).

Temperature

WARNING

The temperature grade for this tire is established for a tire that is properly inflated and not overloaded. Excessive speed, underinflation, or excessive loading, either separately or in combination, can cause excessive heat build-up and possible tire failure.

The temperature grades are A (the highest), B, and C, representing the tire's resistance to the generation of heat and its ability to dissipate heat when tested under controlled conditions on a specified indoor laboratory test wheel. Sustained high temperature can cause the material of the tire to degenerate and reduce tire life, and excessive temperature can lead to sudden tire failure. The grade C corresponds to a level of performance which all passenger car tires must meet under the Federal Motor Vehicle Safety Standard No. 109. Grades B and A represent higher levels of performance on the laboratory test wheel than the minimum required by law.

Tire labeling

Overview

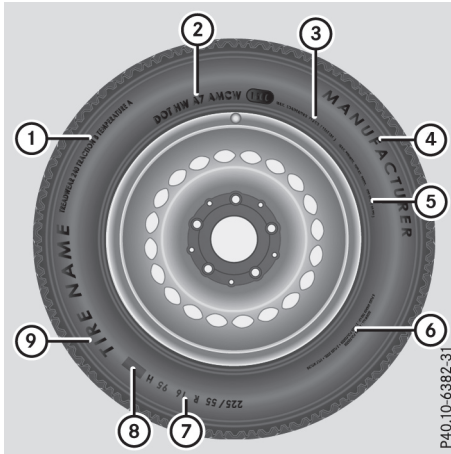

- ① Uniform Tire Quality Grading Standards (▷ page 284)
- ② Department of Transportation, Tire Identification Number (▷ page 283)
- ③ Maximum load rating (▷ page 283)
- ④ Maximum tire pressures (▷ page 275)
- ⑤ Manufacturer
- ⑥ Tire material (▷ page 284)
- ⑦ Tire size designation, load-bearing capacity and speed rating (▷ page 281)
- ⑧ Load index (▷ page 283)
- ⑨ Tire name

The markings described above are on the tire in addition to the tire name (sales designation) and the manufacturer's name.

- ❗ Tire data is vehicle-specific and may deviate from the data in the example.

Tire size designation, load-bearing capacity and speed rating

⚠ WARNING

Exceeding the stated tire load-bearing capacity and the approved maximum speed could lead to tire damage or the tire bursting. There is a risk of accident.

Therefore, only use tire types and sizes approved for your vehicle model. Observe the

tire load rating and speed rating required for your vehicle.

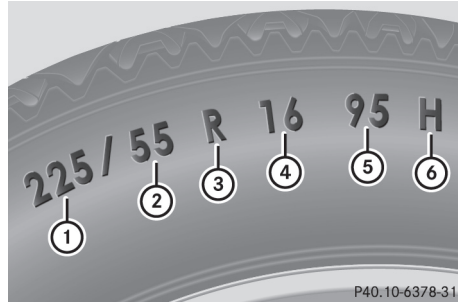

- ① Tire width
- ② Nominal aspect ratio in %
- ③ Tire code
- ④ Rim diameter
- ⑤ Load bearing index
- ⑥ Speed rating

General: depending on the manufacturer's standards, the size imprinted in the tire wall may not contain any letters or may contain one letter that precedes the size description.

If there is no letter preceding the size description (as shown above): these are passenger vehicle tires according to European manufacturing standards.

If "P" precedes the size description: these are passenger vehicle tires according to U.S. manufacturing standards.

If "LT" precedes the size description: these are light truck tires according to U.S. manufacturing standards.

If "T" precedes the size description: compact emergency wheels with high tire pressure that are only designed for temporary use in an emergency.

Tire width: tire width ① shows the nominal tire width in millimeters.

Aspect ratio: aspect ratio ② is the size ratio between the tire height and tire width and is shown in percent. The aspect ratio is calculated by dividing the tire width by the tire height.

Tire code: tire code ③ specifies the tire type. "R" represents radial tires; "D" represents diagonal tires; "B" represents diagonal radial tires.

Optionally, tires with a maximum speed of over 149 mph (240 km/h) may have "ZR" in the size

description, depending on the manufacturer (e.g. 245/40 ZR 18).

Rim diameter: rim diameter ④ is the diameter of the bead seat, not the diameter of the rim flange. The rim diameter is specified in inches (in).

Load-bearing index: load-bearing index ⑤ is a numerical code that specifies the maximum load-bearing capacity of a tire.

Do not overload the tires by exceeding the specified load limit. The maximum permissible load can be found on the vehicle's Tire and Loading Information placard on the B-pillar on the driver's side (▷ page 276).

Example:

Load-bearing index 91 indicates a maximum load of 1,356 lb (615 kg) that the tires can bear. For further information on the maximum tire load in kilograms and lbs, see (▷ page 283).

For further information on the load bearing index, see "Load index" (▷ page 283).

Speed rating: speed rating ⑥ specifies the approved maximum speed of the tire.

i Tire data is vehicle-specific and may deviate from the data in the example.

Regardless of the speed rating, always observe the speed limits. Drive carefully and adapt your driving style to the traffic conditions.

Summer tires

| Index | Speed rating |
|------------|--------------------------|
| Q | up to 100 mph (160 km/h) |
| R | up to 106 mph (170 km/h) |
| S | up to 112 mph (180 km/h) |
| T | up to 118 mph (190 km/h) |
| H | up to 130 mph (210 km/h) |
| V | up to 149 mph (240 km/h) |
| W | up to 168 mph (270 km/h) |
| Y | up to 186 mph (300 km/h) |
| ZR...Y | up to 186 mph (300 km/h) |
| ZR...(..Y) | over 186 mph (300 km/h) |
| ZR | over 149 mph (240 km/h) |

- Optionally, tires with a maximum speed of over 149 mph (240 km/h) may have "ZR" in the size description, depending on the manufacturer (e.g. 245/40 ZR18).

The service specification is made up of load-bearing index ⑤ and speed rating ⑥.

- If the size description of your tire includes "ZR" and there are no service specifications, ask the tire manufacturer in order to find out the maximum speed.

If a service specification is available, the maximum speed is limited according to the speed rating in the service specification. Example: 245/40 ZR18 97 Y. In this example, "97 Y" is the service specification. The letter "Y" represents the speed rating. The maximum speed of the tire is limited to 186 mph (300 km/h).

- The size description for all tires with maximum speeds of over 186 mph (300 km/h) must include "ZR" **and** the service specification must be given in parentheses. Example: 275/40 ZR 18 (99 Y). Speed rating "(Y)" indicates that the maximum speed of the tire is over 186 mph (300 km/h). Ask the tire manufacturer about the maximum speed.

All-weather tires and winter tires

| Index | Speed rating |
|--------------------|--------------------------|
| Q M+S ¹ | up to 100 mph (160 km/h) |
| T M+S ¹ | up to 118 mph (190 km/h) |
| H M+S ¹ | up to 130 mph (210 km/h) |
| V M+S ¹ | up to 149 mph (240 km/h) |

i Not all tires with the M+S marking provide the driving characteristics of winter tires. In addition to the M+S marking, winter tires also have the  snowflake symbol on the tire wall. Tires with this marking fulfill the requirements of the Rubber Manufacturers Association (RMA) and the Rubber Association of Canada (RAC) regarding the tire traction on snow. They have been especially developed for driving on snow.

An electronic speed limiter prevents your vehicle from exceeding a speed of 130 mph (210 km/h).

¹ Or M+S  for winter tires.

The speed rating of tires mounted at the factory may be higher than the maximum speed that the electronic speed limiter permits.

Make sure that your tires have the required speed rating, e.g. when buying new tires. The required speed rating for your vehicle can be found in the "Tires" section (▷ page 290).

Further information about reading tire data can be obtained from any qualified specialist workshop.

Load index



In addition to the load-bearing index, load index ① may be imprinted after the letters that identify speed rating on the sidewall of the tire. Speed rating (▷ page 281).

- If no specification is given: no text (as in the example above), represents a standard load (SL) tire
- XL or Extra Load: represents a reinforced tire
- Light Load: represents a light load tire
- C, D, E: represents a load range that depends on the maximum load that the tire can carry at a certain pressure

i Tire data is vehicle-specific and may deviate from the data in the example.

Maximum load rating



Maximum tire load ① is the maximum permissible weight for which the tire is approved.

Do not overload the tires by exceeding the specified load limit. The maximum permissible load can be found on the vehicle's Tire and Loading Information placard on the B-pillar on the driver's side (▷ page 276).

i The actual values for tires are vehicle-specific and may deviate from the values in the illustration.

DOT, Tire Identification Number (TIN)

US tire regulations stipulate that every tire manufacturer or retreader must imprint a TIN in or on the sidewall of each tire produced.

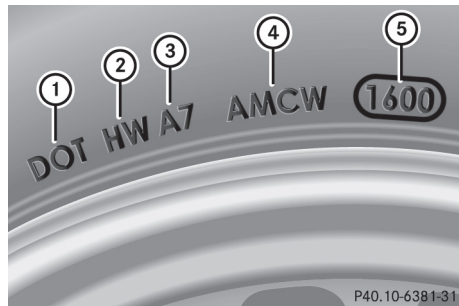

The TIN is a unique identification number. The TIN enables the tire manufacturers or retreaders to inform purchasers of recalls and other safety-relevant matters. It makes it possible for the purchaser to easily identify the affected tires.

The TIN is made up of manufacturer identification code ②, tire size ③, tire type code ④ and manufacturing date ⑤.

DOT (Department of Transportation): tire symbol ① marks that the tire complies with the

requirements of the U.S. Department of Transportation.

Manufacturer identification code: manufacturer identification code ② provides details on the tire manufacturer. New tires have a code with two symbols. Retreaded tires have a code with four symbols.

For further information about retreaded tires, see (> page 290).

Tire size: identifier ③ describes the tire size.

Tire type code: tire type code ④ can be used by the manufacturer as a code to describe specific characteristics of the tire.

Date of manufacture: date of manufacture ⑤ provides information about the age of a tire. The first and second positions represent the week of manufacture, starting with "01" for the first calendar week. Positions three and four represent the year of manufacture. For example, a tire that is marked with "3208", was manufactured in week 32 in 2008.

- i** Tire data is vehicle-specific and may deviate from the data in the example.

Tire characteristics

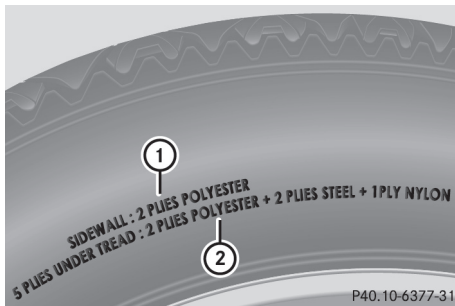

This information describes the type of tire cord and the number of layers in sidewall ① and under tire tread ②.

- i** Tire data is vehicle-specific and may deviate from the data in the example.

Definition of terms for tires and loading

Tire ply composition and material used

Describes the number of plies or the number of layers of rubber-coated fabric in the tire tread and sidewall. These are made of steel, nylon, polyester and other materials.

Bar

Metric unit for tire pressure. 14.5038 pounds per square inch (psi) and 100 kilopascals (kPa) are the equivalent of 1 bar.

DOT (Department of Transportation)

DOT-marked tires fulfill the requirements of the U S Department of Transportation.

Normal occupant weight

The number of occupants for which the vehicle is designed multiplied by 68 kilograms (150 lbs).

Uniform Tire Quality Grading Standards

A uniform standard to grade the quality of tires with regards to tread quality, tire traction and temperature characteristics. The quality grading assessment is made by the manufacturer following specifications from the U.S. government. The ratings are molded into the sidewall of the tire.

Recommended tire pressures

The recommended tire pressure applies to the tires mounted at the factory.

The Tire and Loading Information placard contains the recommended tire pressures for cold tires on a fully loaded vehicle and for the maximum permissible vehicle speed.

The tire pressure table contains the recommended pressures for cold tires for various operating conditions, i.e. differing load and speed conditions.

Increased vehicle weight due to optional equipment

The combined weight of all standard and optional equipment available for the vehicle, regardless of whether it is actually installed on the vehicle or not.

Rim

This is the part of the wheel on which the tire is mounted.

GAWR (Gross Axle Weight Rating)

The GAWR is the maximum gross axle weight rating. The actual load on an axle must never exceed the gross axle weight rating. The gross axle weight rating can be found on the vehicle identification plate on the B-pillar on the driver's side.

Speed rating

The speed rating is part of the tire identification. It specifies the speed range for which the tire is approved.

GVW (Gross Vehicle Weight)

The gross vehicle weight includes the weight of the vehicle including fuel, tools, the spare wheel, accessories installed, occupants, luggage and the drawbar noseweight, if applicable. The gross vehicle weight must not exceed the gross vehicle weight rating GVWR as specified on the vehicle identification plate on the B-pillar on the driver's side.

GVWR (Gross Vehicle Weight Rating)

The GVWR is the maximum permissible gross weight of a fully loaded vehicle (the weight of the vehicle including all accessories, occupants, fuel, luggage and the drawbar noseweight, if applicable). The gross vehicle weight rating is specified on the vehicle identification plate on the B-pillar on the driver's side.

Maximum loaded vehicle weight

The maximum weight is the sum of:

- the curb weight of the vehicle
- the weight of the accessories
- the load limit
- the weight of the factory installed optional equipment

Kilopascal (kPa)

Metric unit for tire pressure. 6.9 kPa corresponds to 1 psi. Another unit for tire pressure is bar. 100 kilopascals (kPa) are the equivalent of 1 bar.

Load index

In addition to the load-bearing index, the load index may also be imprinted on the sidewall of the tire. This specifies the load-bearing capacity more precisely.

Curb weight

The weight of a vehicle with standard equipment including the maximum capacity of fuel, oil and coolant. It also includes the air-conditioning system and optional equipment if these are installed in the vehicle, but does not include passengers or luggage.

Maximum load rating

The maximum tire load is the maximum permissible weight in kilograms or lbs for which a tire is approved.

Maximum permissible tire pressure

Maximum permissible tire pressure for one tire.

Maximum load on one tire

Maximum load on one tire. This is calculated by dividing the maximum axle load of one axle by two.

PSI (pounds per square inch)

A standard unit of measure for tire pressure.

Aspect ratio

Relationship between tire height and tire width in percent.

Tire pressure

This is pressure inside the tire applying an outward force to each square inch of the tire's surface. The tire pressure is specified in pounds per square inch (psi), in kilopascal (kPa) or in bar. The tire pressure should only be corrected when the tires are cold.

Cold tire pressure

The tires are cold:

- if the vehicle has been parked with the tires out of direct sunlight for at least three hours and
- if the vehicle has not been driven further than 1 mile (1.6 km)

Tread

The part of the tire that comes into contact with the road.

Bead

The tire bead ensures that the tire sits securely on the wheel. There are several steel wires in the bead to prevent the tire from coming loose from the wheel rim.

Sidewall

The part of the tire between the tread and the bead.

Weight of optional extras

The combined weight of those optional extras that weigh more than the replaced standard parts and more than 2.3 kg (5 lbs). These optional extras, such as high-performance brakes, level control, a roof rack or a high-performance battery, are not included in the curb weight and the weight of the accessories.

TIN (Tire Identification Number)

This is a unique identifier which can be used by a tire manufacturer to identify tires, for example for a product recall, and thus identify the purchasers. The TIN is made up of the manufacturer's identity code, tire size, tire type code and the manufacturing date.

Load bearing index

The load bearing index (also load index) is a code that contains the maximum load bearing capacity of a tire.

Traction

Traction is the result of friction between the tires and the road surface.

Treadwear indicators

Narrow bars (tread wear bars) that are distributed over the tire tread. If the tire tread is level with the bars, the wear limit of $\frac{1}{16}$ in (1.6 mm) has been reached.

Occupant distribution

The distribution of occupants in a vehicle at their designated seating positions.

Total load limit

Nominal load and luggage load plus 68 kg (150 lbs) multiplied by the number of seats in the vehicle.

Changing a wheel

Flat tire

The "Breakdown assistance" section (> page 253) contains information and notes on how to deal with a flat tire. Information on driving with MOExtended tires in the event of a flat tire can be found under "MOExtended tires (tires with run-flat characteristics)" (> page 254).

Rotating the wheels

WARNING

Interchanging the front and rear wheels may severely impair the driving characteristics if the wheels or tires have different dimensions. The wheel brakes or suspension components may also be damaged. There is a risk of accident.

Rotate front and rear wheels only if the wheels and tires are of the same dimensions.

Observe the instructions and safety notes in the "Changing a wheel" section (> page 286).

The wear patterns on the front and rear tires differ, depending on the operating conditions. Rotate the wheels before a clear wear pattern has formed on the tires. Front tires typically wear more on the shoulders and the rear tires in the center.

On vehicles that have the same size front and rear wheels, you can rotate the wheels according to the intervals in the tire manufacturer's warranty book in your vehicle documents. If no warranty book is available, the tires should be rotated every 3,000 to 6,000 miles (5,000 to 10,000 km). Depending on tire wear, this may be required earlier. Do not change the direction of wheel rotation.

Clean the contact surfaces of the wheel and the brake disc thoroughly every time a wheel is rotated. Check the tire pressure and, if necessary, restart the tire pressure loss warning system.

Direction of rotation

Tires with a specified direction of rotation have additional benefits, e.g. if there is a risk of hydroplaning. These advantages can only be gained if the tires are installed corresponding to the direction of rotation.

An arrow on the sidewall of the tire indicates its correct direction of rotation.

Storing wheels

Store wheels that are not being used in a cool, dry and preferably dark place. Protect the tires from oil, grease, gasoline and diesel.

Mounting a wheel

Preparing the vehicle

- ▶ Stop the vehicle on solid, non-slippery and level ground.
- ▶ Apply the electric parking brake manually.
- ▶ Bring the front wheels into the straight-ahead position.
- ▶ Shift the transmission to position **P**.
- ▶ Switch off the engine.
- ▶ **Vehicles without KEYLESS-GO:** remove the SmartKey from the ignition lock.
- ▶ **Vehicles with KEYLESS-GO start-function or KEYLESS-GO:** open the driver's door. The vehicle electronics are now in position **O**. This is the same as "key removed".
- ▶ **Vehicles with KEYLESS-GO start-function or KEYLESS-GO:** remove the Start/Stop button from the ignition lock (▷ page 114).
- ▶ Make sure that the engine cannot be started via your smartphone (▷ page 76).
- ▶ If included in the vehicle equipment, remove the tire-change tool kit from the vehicle.
- ▶ Safeguard the vehicle against rolling away (▷ page 129).

i Apart from certain country-specific variations, the vehicles are not equipped with a tire-change tool kit. Some tools for changing a wheel are specific to the vehicle. For more information on which tools are required to perform a wheel change on your vehicle, consult a qualified specialist workshop.

Necessary tire-changing tools can include, for example:

- Jack
- Wheel chock
- Lug wrench

Securing the vehicle to prevent it from rolling away

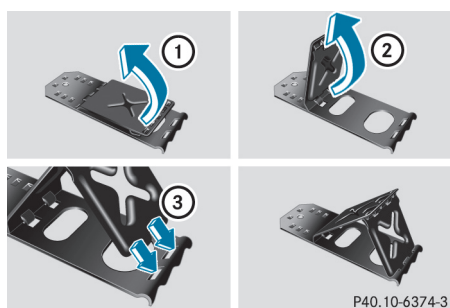

If your vehicle is equipped with a wheel chock, it can be found in the tire-change tool kit (▷ page 252).

The folding wheel chock is an additional safety measure to prevent the vehicle from rolling away, for example when changing a wheel.

- ▶ Fold both plates up ①.
- ▶ Fold out lower plate ②.
- ▶ Guide the lugs on the lower plate fully into the openings in base plate ③.



- ▶ Place chocks or other suitable items under the front and rear of the wheel that is diagonally opposite the wheel you wish to change.

Raising the vehicle

⚠ WARNING

If you do not position the jack correctly at the appropriate jacking point of the vehicle, the jack could tip over with the vehicle raised. There is a risk of injury.

Only position the jack at the appropriate jacking point of the vehicle. The base of the jack

must be positioned vertically, directly under the jacking point of the vehicle.

! Only position the jack at the appropriate jacking point of the vehicle. Otherwise, you could damage the vehicle.

Observe the following when raising the vehicle:

- To raise the vehicle, only use the vehicle-specific jack that has been tested and approved by Mercedes-Benz. If used incorrectly, the jack could tip over with the vehicle raised.
- The jack is designed only to raise and hold the vehicle for a short time while a wheel is being changed. It must not be used for performing maintenance work under the vehicle.
- Avoid changing the wheel on uphill and downhill slopes.
- Before raising the vehicle, secure it from rolling away by applying the parking brake and inserting wheel chocks. Do not disengage the parking brake while the vehicle is raised.
- The jack must be placed on a firm, flat and non-slip surface. On a loose surface, a large, flat, load-bearing underlay must be used. On a slippery surface, a non-slip underlay must be used, e.g. rubber mats.
- Do not use wooden blocks or similar objects as a jack underlay. Otherwise, the jack will not be able to achieve its load-bearing capacity due to the restricted height.
- Make sure that the distance between the underside of the tires and the ground does not exceed 1.2 in (3 cm).
- Never place your hands and feet under the raised vehicle.
- Do not lie under the vehicle.
- Do not start the engine when the vehicle is raised.
- Never open or close a door or the tailgate when the vehicle is raised.
- Make sure that no persons are present in the vehicle when the vehicle is raised.

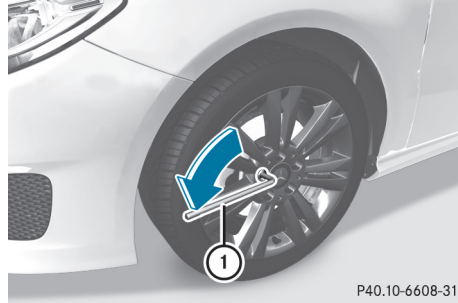

- Using lug wrench ①, loosen the bolts on the wheel you wish to change by about one full turn. Do not unscrew the bolts completely.

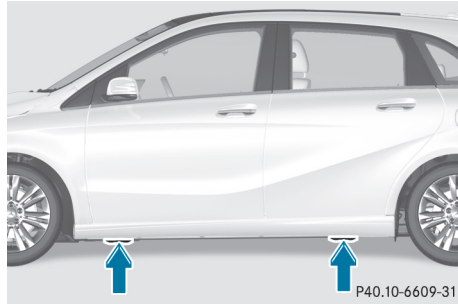

Jacking points

The jacking points are located just behind the front wheel housings and just in front of the rear wheel housings (arrows).

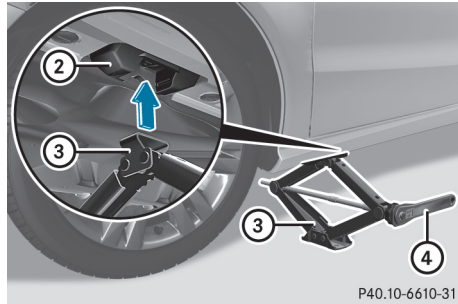

- Take ratchet wrench ④ out of the vehicle tool kit and place it on the hexagon nut of jack ③ so that the letters **AUF** are visible.
- Position jack ③ at jacking point ②.

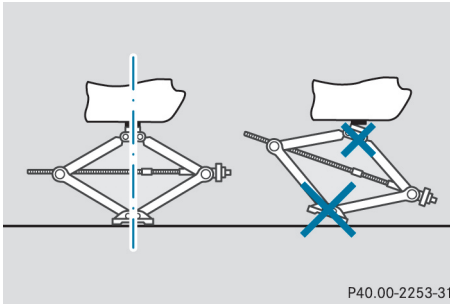

P40.00-2253-31

- ▶ Make sure the foot of the jack is directly beneath the jacking point.
- ▶ Turn ratchet wrench ④ until jack ③ sits completely on jacking point ② and the base of the jack lies evenly on the ground.
- ▶ Turn ratchet wrench ④ until the tire is raised a maximum of 1.2 in (3 cm) from the ground.

Removing a wheel

- ❗ Do not place wheel bolts in sand or on a dirty surface. The bolt and wheel hub threads could otherwise be damaged when you screw them in.
- ▶ Unscrew the wheel bolts.
- ▶ Remove the wheel.

Mounting a new wheel

⚠ WARNING

Oiled or greased wheel bolts or damaged wheel bolts/hub threads can cause the wheel bolts to come loose. As a result, you could lose a wheel while driving. There is a risk of accident.

Never oil or grease wheel bolts. In the event of damage to the threads, contact a qualified specialist workshop immediately. Have the damaged wheel bolts or hub threads replaced/renewed. Do not continue driving.

⚠ WARNING

If you tighten the wheel bolts or wheel nuts when the vehicle is raised, the jack could tip over. There is a risk of injury.

Only tighten the wheel bolts or wheel nuts when the vehicle is on the ground.

Always pay attention to the instructions and safety notes in the "Changing a wheel" section (▷ page 286).

Only use wheel bolts that have been designed for the wheel and the vehicle. For safety reasons, Mercedes-Benz recommends that you only use wheel bolts which have been approved for Mercedes-Benz vehicles and the respective wheel.

- ❗ To prevent damage to the paintwork, hold the wheel securely against the wheel hub while screwing in the first wheel bolt.



P40.10-6611-31

- ▶ Clean the wheel and wheel hub contact surfaces.
- ▶ Place the new wheel on the wheel hub and push it on.
- ▶ Tighten the wheel bolts until they are finger-tight.

Lowering the vehicle

⚠ WARNING

The wheels could work loose if the wheel nuts and bolts are not tightened to the specified tightening torque. There is a risk of accident. Have the tightening torque immediately checked at a qualified specialist workshop after a wheel is changed.

- ▶ Place the ratchet wrench onto the hexagon nut of the jack so that the letters **AB** are visible.
- ▶ Turn the ratchet wrench until the vehicle is once again standing firmly on the ground.
- ▶ Place the jack to one side.

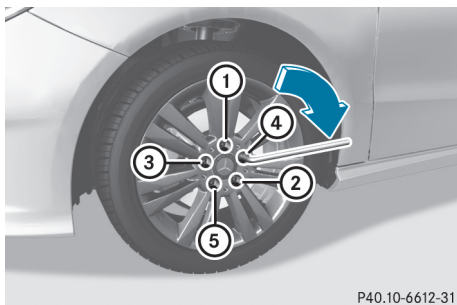

- ▶ Tighten the wheel bolts evenly in a crosswise pattern in the sequence indicated (① to ⑤). The specified tightening torque is **96 lb-ft (130 Nm)**.
- ▶ Turn the jack back to its initial position.
- ▶ Stow the jack and the rest of the vehicle tools in the vehicle again.
- ▶ Check the tire pressure of the newly mounted wheel and adjust it if necessary. Observe the recommended tire pressure (> page 272).

When you are driving with the emergency spare wheel mounted, the tire pressure loss warning system cannot function reliably. Only restart the tire pressure loss warning system when the defective wheel has been replaced with a new wheel.

Wheel and tire combinations

General notes

You can ask for information regarding permitted wheel/tire combinations at an authorized Mercedes-Benz Center.

You should regularly check the pressure of the emergency spare wheel, particularly prior to long trips, and correct the pressure as necessary (> page 272). The value on the wheel is valid.

- ❗ For safety reasons, Mercedes-Benz recommends that you only use tires and wheels which have been approved by Mercedes-Benz specifically for your vehicle.

These tires have been specially adapted for use with the control systems, such as ABS or ESP®, and are marked as follows:

- MO = Mercedes-Benz Original
- MOE = Mercedes-Benz Original Extended (tires featuring run-flat characteristics)
- MO1 = Mercedes-Benz Original (only certain AMG tires)

Mercedes-Benz Original Extended tires may only be used on wheels that have been specifically approved by Mercedes-Benz.

Only use tires, wheels or accessories tested and approved by Mercedes-Benz. Certain characteristics, e.g. handling, vehicle noise emissions or fuel consumption, may otherwise be adversely affected. In addition, when driving with a load, tire dimension variations could cause the tires to come into contact with the bodywork and axle components. This could result in damage to the tires or the vehicle.

Mercedes-Benz accepts no liability for damage resulting from the use of tires, wheels or accessories other than those tested and approved.

Information on tires, wheels and approved combinations can be obtained from any qualified specialist workshop.

- ❗ Retreaded tires are neither tested nor recommended by Mercedes-Benz, since previous damage cannot always be detected on retreaded tires. As a result, Mercedes-Benz cannot guarantee vehicle safety if retreaded tires are mounted. Do not mount used tires if you have no information about their previous usage.

The recommended pressures for various operating conditions can be found:

- on the Tire and Loading Information placard on the B-pillar on the driver's side
- in the tire pressure table in the fuel filler flap

Observe the notes on recommended tire pressures under various operating conditions (> page 272).

Check tire pressures regularly, and only when the tires are cold. Comply with the maintenance recommendations of the tire manufacturer in the vehicle document wallet.

Notes on the vehicle equipment – always equip the vehicle:

- with tires of the same size on a given axle (left and right)
- with the same type of tire (summer tires, MOExtended tires, winter tires)
Exception: it is permissible to install a different type or make in the event of a flat tire. Observe the "MOExtended tires (tires with run-flat characteristics" section (▷ page 254).

Vehicles equipped with MOExtended tires are not equipped with a TIREFIT kit at the factory. It is therefore recommended that you additionally equip your vehicle with a TIREFIT kit if you mount tires that do not feature run-flat properties, e.g. winter tires. A TIREFIT kit may be obtained from a qualified specialist workshop.

Emergency spare wheel

Important safety notes

WARNING

The wheel or tire size as well as the tire type of the spare wheel or emergency spare wheel and the wheel to be replaced may differ. Mounting an emergency spare wheel may severely impair the driving characteristics. There is a risk of an accident.

To avoid hazardous situations:

- adapt your driving style accordingly and drive carefully.
- never mount more than one spare wheel or emergency spare wheel that differs in size.
- only use a spare wheel or emergency spare wheel of a different size briefly.
- do not switch ESP® off.
- have a spare wheel or emergency spare wheel of a different size replaced at the nearest qualified specialist workshop. Observe that the wheel and tire dimensions as well as the tire type must be correct.

When using an emergency spare wheel or spare wheel of a different size, you must not exceed the vehicle's maximum design speed of 50 mph (80 km/h).

You should regularly check the pressure of the emergency spare wheel, particularly prior to long trips, and correct the pressure as necessary (▷ page 272). The value on the wheel is valid.

Snow chains must not be mounted on emergency spare wheels.

General notes

You can ask for information regarding permitted emergency spare wheels at an authorized Mercedes-Benz Center.

An emergency spare wheel may also be mounted against the direction of rotation. Observe the time restriction on use as well as the speed limitation specified on the emergency spare wheel.

Replace the tires after six years at the latest, regardless of wear. This also applies to the emergency spare wheel.

When you are driving with the emergency spare wheel mounted, the tire pressure loss warning system cannot function reliably. Only restart the tire pressure loss warning system when the defective wheel has been replaced with a new wheel.

Removing the emergency spare wheel

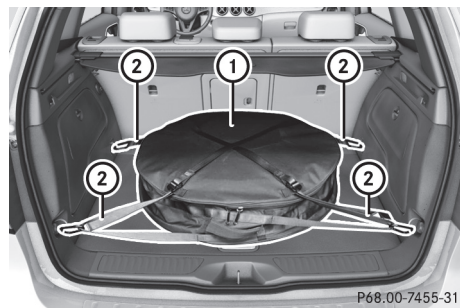

Vehicles with the "Minispare" emergency spare wheel

The "Minispare" emergency spare wheel is secured in emergency spare wheel bag ① in the cargo compartment.

- ▶ Open the tailgate.
- ▶ Release securing straps ② on emergency spare wheel bag ①.

- ▶ Remove emergency spare wheel bag ① with the "Minispare" emergency spare wheel.
- ▶ Open emergency spare wheel bag ① and remove the "Minispare" emergency spare wheel.

Observe the instructions and safety notes in the "Changing a wheel" section (▷ page 287).

Information regarding technical data

- i** The data stated here specifically refers to a vehicle with standard equipment. Consult an authorized Mercedes-Benz Center for the data for all vehicle variants and trim levels.

Vehicle electronics

Installing two-way radios and mobile phones (RF transmitters)

⚠ WARNING

The electromagnetic radiation from two-way radios can interfere with the vehicle electronics if two-way radios are manipulated or retrofitted incorrectly. This could jeopardize the operating safety of the vehicle. There is a risk of an accident.

You should have all work on electrical and electronic components carried out at a qualified specialist workshop.

⚠ WARNING

If you incorrectly operate two-way radios in the vehicle, the electromagnetic radiation may interfere with the vehicle electronics, for example if:

- the two-way radio is not connected to an exterior antenna
- the exterior antenna is not correctly mounted or is not low-reflection

This could jeopardize the operating safety of the vehicle. There is a risk of an accident.

Have the low-reflection exterior antenna installed at a qualified specialist workshop. Always connect two-way radios to the low-reflection exterior antenna when operating in the vehicle.

- !** The operating permit may be invalidated if the instructions for installation and use of two-way radios are not observed.

In particular, the following conditions must be complied with:

- only approved wavebands may be used
- observe the maximum permissible output in these wavebands
- only approved antenna positions may be used

Excessive levels of electromagnetic radiation may cause damage to your health and the health of others. Using an exterior antenna takes into account current scientific discussions relating to the possible health hazards that may result from electromagnetic fields.

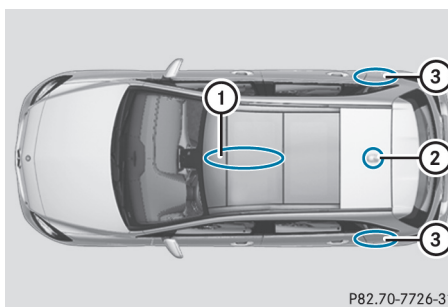

P82.70-7726-31

Approved antenna positions

- ① Front roof area
- ② Rear roof area
- ③ Rear fender

- i** On vehicles with panorama roof with power tilt/sliding panel, installing an antenna to the front or rear roof area is not permitted.

On the rear fenders, it is recommended to position the antenna on the side of the vehicle closest to the center of the road.

Use the Technical Specification ISO/TS 21609 when retrofitting RF transmitters (Road Vehicles - EMC guidelines for installation of aftermarket radio frequency transmitting equipment). Observe the legal requirements for accessory parts.

If your vehicle has installations for two-way radio equipment, use the power supply or antenna connections intended for use with the basic wiring. Be sure to observe the manufacturer's Supplement when installing.

Deviations with respect to frequency bands, maximum transmission outputs or antenna positions must be approved by Mercedes-Benz.

The maximum transmission output (PEAK) at the base of the antenna must not exceed the following values:

| Frequency band | Maximum transmission output |
|---|-----------------------------|
| Short wave 3 - 54 MHz | 100 W |
| 4 m waveband 74 - 88 MHz | 30 W |
| 2 m waveband 144 - 174 MHz | 50 W |
| Trunked radio system/ Tetra 380 - 460 MHz | 10 W |
| 70 cm waveband 400 - 460 MHz | 35 W |
| Mobile communications (2G/3G/4G) | 10 W |

The following can be used in the vehicle without restrictions:

- RF transmitters with a maximum transmission output of up to 100 mW
- RF transmitters with transmitter frequencies in the 380 - 410 MHz frequency band and a maximum transmission output of up to 2 W (trunked radio system/Tetra)
- Mobile phones (2G/3G/4G)

There is no restriction for antenna positions on the outside of the vehicle for the following frequency bands:

- Trunked radio system/Tetra
- 70 cm waveband
- 2G/3G/4G

Identification plates

Vehicle identification plate with vehicle identification number (VIN)



- Open the driver's door.
You will see vehicle identification plate ①.

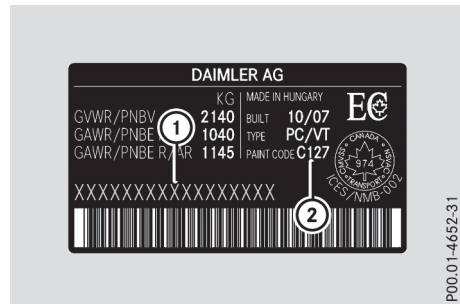

- ① VIN
② Paint code

- i** The data shown on the vehicle identification plate is used only as an example. This data is different for every vehicle and can deviate from the data shown here. You can find the data applicable to your vehicle on the vehicle identification plate.

Vehicle identification number (VIN)

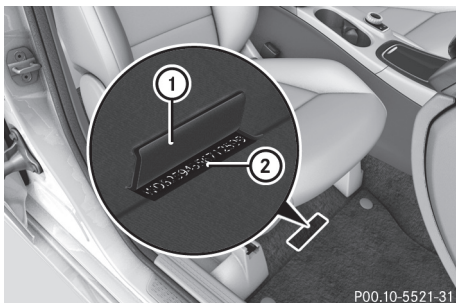

- ▶ Slide the right-hand front seat to its rearmost position.
- ▶ Fold floor covering ① upwards. You will see VIN ②.

The VIN can also be found on the vehicle identification plate (▷ page 294).

The VIN can also be found at the lower edge of the windshield (▷ page 295).

Engine number

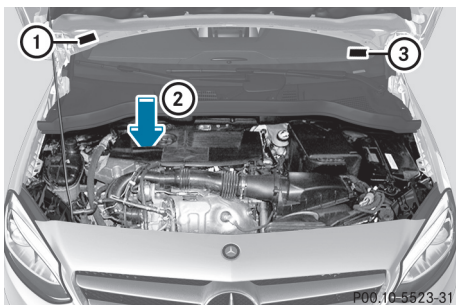

- ① Emissions control information plate
- ② Engine number (stamped into the crankcase)
- ③ VIN (on the lower edge of the windshield)

Service products and filling capacities

Important safety notes

⚠ WARNING

Service products may be poisonous and hazardous to health. There is a risk of injury.

Comply with instructions on the use, storage and disposal of service products on the labels of the respective original containers. Always store service products sealed in their original containers. Always keep service products out of the reach of children.

♻ Environmental note

Dispose of service products in an environmentally responsible manner.

Service products include the following:

- Fuels
- Lubricants (e.g. engine oil, transmission oil)
- Coolant
- Brake fluid
- Windshield washer fluid
- Climate control system refrigerant

Components and service products must match. Only use products recommended by Mercedes-Benz. Damage which is caused by the use of products which have not been recommended is not covered by the Mercedes-Benz warranty or goodwill gestures. Products approved by Mercedes-Benz are listed in this Operator's Manual in the appropriate section.

Information on tested and approved products can be obtained at a Mercedes-Benz Service Center or on the Internet at <http://bevo.mercedes-benz.com>.

You can recognize service products approved by Mercedes-Benz by the following inscription on the containers:

- MB-Freigabe (e.g. MB-Freigabe 229.51)
- MB-Approval (e.g. MB-Approval 229.51)

Other designations or recommendations indicate a level of quality or a specification in accordance with an MB Sheet Number (e.g. MB 229.5). They have not necessarily been approved by Mercedes-Benz.

Other identifications, for example:

- 0 W-30
- 5 W-30
- 5 W-40

Fuel

Important safety notes

WARNING

Fuel is highly flammable. If you handle fuel incorrectly, there is a risk of fire and explosion.

You must avoid fire, open flames, creating sparks and smoking. Switch off the engine and, if applicable, the auxiliary heating before refueling.

WARNING

Fuel is poisonous and hazardous to health. There is a risk of injury.

You must make sure that fuel does not come into contact with your skin, eyes or clothing and that it is not swallowed. Do not inhale fuel vapors. Keep fuel away from children.

If you or others come into contact with fuel, observe the following:

- Wash away fuel from skin immediately using soap and water.
- If fuel comes into contact with your eyes, immediately rinse them thoroughly with clean water. Seek medical assistance without delay.
- If fuel is swallowed, seek medical assistance without delay. Do not induce vomiting.
- Immediately change out of clothing which has come into contact with fuel.

Tank capacity

| Model | Total capacity |
|---------------------------|-------------------------|
| Models with 4MATIC | 14.8 US gal (56.0 l) |
| All other models | 13.2 US gal (50.0 l) |

| Model | Of which reserve |
|-------------------|----------------------------------|
| All models | Approx. 1.6 US gal (6.0 l) |

Gasoline

Fuel grade

! Do not use diesel to refuel vehicles with a gasoline engine. Do not switch on the ignition if you accidentally refuel with the wrong fuel. Otherwise, the fuel will enter the fuel system. Even small amounts of the wrong fuel could result in damage to the fuel system and the engine. Notify a qualified specialist workshop and have the fuel tank and fuel lines drained completely.

! Only refuel using unleaded premium grade gasoline with at least 91 AKI/95 RON.

i E10 fuel contains up to 10% bioethanol. Your vehicle is E10-compatible. You can refuel your vehicle using E10 fuel.

! Only use the fuel recommended. Operating the vehicle with other fuels can lead to damage to the fuel system, engine and exhaust system.

! Do not use the following:

- Gasoline with more than 10% ethanol
- E100 (100% ethanol)
- Gasoline with methanol
- M100 (100% methanol)
- Gasoline with metalliferous additives
- Diesel

Do not mix such fuels with the fuel recommended for your vehicle.

! To ensure the longevity and full performance of the engine, only premium-grade unleaded gasoline must be used.

If standard unleaded gasoline is unavailable and you have to refuel with unleaded gasoline of a lower grade, observe the following precautions:

- Only fill the fuel tank to half full with regular unleaded gasoline and fill the rest with pre-

mium-grade unleaded gasoline as soon as possible.

- Do not drive at the maximum speed.
- Avoid sudden acceleration and engine speeds over 3,000 rpm.

You will usually find information about the fuel grade on the fuel pump. If you cannot find the label on the fuel pump, ask the gas station staff.

i For more information, contact a qualified specialist workshop.

B 250, B 250 4MATIC: as a temporary measure, if the recommended fuel is not available, you may also use regular unleaded gasoline with an octane rating of 88 AKI/93 RON.

All other models: as a temporary measure, if the recommended fuel is not available, you may also use regular unleaded gasoline with an octane rating of 87 AKI/91 RON. This may reduce engine performance and increase fuel consumption. Avoid driving at full throttle and sudden acceleration. Never refuel using gasoline with a lower AKI.

i The fuels you can use in your vehicle may differ from the information in the Operator's Manual depending on the country. The fuels that have been approved for your vehicle can be found on the instruction label on the inside of the fuel filler flap.

Information on refueling (▷ page 127).

Additives

! Operating the engine with fuel additives added later can lead to engine failure. Do not mix fuel additives with fuel. This does not include additives for the removal and prevention of residue buildup. Gasoline must only be mixed with additives recommended by Mercedes-Benz. Comply with the instructions for use on the product label. More information about recommended additives can be obtained from any authorized Mercedes-Benz Center.

Mercedes-Benz recommends that you use branded fuels that have additives.

The fuel quality available in some countries may not be sufficient. Residue could build up in the fuel injection system as a result. In such cases, and in consultation with an authorized Mercedes-Benz Center, the fuel may be mixed with the cleaning additive recommended by

Mercedes-Benz. You must observe the notes and mixing ratios specified on the container.

Engine oil

General notes



! Do not use engine oil or an oil filter with specifications deviating from those expressly required for the prescribed service intervals. Do not change the engine oil or oil filter in order to set replacement intervals longer than those prescribed. This could otherwise cause damage to the engine or exhaust gas aftertreatment.

Follow the instructions on the service interval display for changing the engine oil. This could otherwise cause damage to the engine or exhaust gas aftertreatment.

When handling engine oil, observe the important safety notes on service products (▷ page 295). The engine oils are matched to the performance of Mercedes-Benz engines and service intervals. You should therefore only use engine oils and oil filters that are approved for vehicles with maintenance systems.

For a list of approved engine oils and oil filters, consult an authorized Mercedes-Benz Center. Or visit the website <http://bevo.mercedes-benz.com>.

The table shows which engine oils have been approved for your vehicle.

| Model | MB-Freigabe or MB-Approval |
|------------|----------------------------|
| All models | 229.5, 229.6 |

i MB approval is indicated on the oil containers.

Filling capacities

The following values refer to an engine oil change, including the oil filter.

| Model | Capacity |
|------------|-------------------|
| All models | 5.9 US qt (5.6 l) |

Additives

! Do not use any additives in the engine oil. This could damage the engine.

Brake fluid

WARNING

The brake fluid constantly absorbs moisture from the air. This lowers the boiling point of the brake fluid. If the boiling point of the brake fluid is too low, vapor pockets may form in the brake system when the brakes are applied hard. This would impair braking efficiency. There is a risk of an accident.

You should have the brake fluid renewed at the specified intervals.

When handling brake fluid, observe the important safety notes on service products (> page 295).

The brake fluid change intervals can be found in the Maintenance Booklet.

Only use brake fluid approved by Mercedes-Benz in accordance with MB-Freigabe or MB-Approval 331.0.

Information about approved brake fluid can be obtained at any qualified specialist workshop or on the Internet at <http://bevo.mercedes-benz.com>.

i Have the brake fluid regularly replaced at a qualified specialist workshop and the replacement confirmed in the Maintenance Booklet.

Coolant

Important safety notes

WARNING

If antifreeze comes into contact with hot components in the engine compartment, it may ignite. There is a risk of fire and injury.

Let the engine cool down before you add antifreeze. Make sure that antifreeze is not spilled next to the filler neck. Thoroughly clean the antifreeze from components before starting the engine.

! Only add coolant that has been premixed with the desired antifreeze protection. You could otherwise damage the engine.

Further information on coolants can be found in the Mercedes-Benz Specifications for Service Products, MB BeVo 310.1, e.g. on the Internet at

http://bevo.mercedes-benz.com. Or contact a qualified specialist workshop.

! Always use a suitable coolant mixture, even in countries where high temperatures prevail. Otherwise, the engine cooling system is not sufficiently protected from corrosion and overheating.

i Have the coolant regularly replaced at a qualified specialist workshop and the replacement confirmed in the Maintenance Booklet.

Comply with the important safety precautions for service products when handling coolant (> page 295).

The coolant is a mixture of water and corrosion inhibitor/antifreeze concentrate. It performs the following tasks:

- anti-corrosion protection
- antifreeze protection
- raising the boiling point

If the coolant has antifreeze protection down to -35 °F (-37 °C), the boiling point of the coolant during operation is approximately 266 °F (130 °C).

The antifreeze concentrate/corrosion inhibitor concentration in the engine cooling system should:

- be at least 50%. This will protect the engine cooling system against freezing down to approximately -35 °F (-37 °C)
- not exceed 55% (antifreeze protection down to -49 °F [-45 °C]). Otherwise, heat will not be dissipated as effectively

Mercedes-Benz recommends a coolant or corrosion inhibitor/antifreeze concentrate in accordance with MB Specifications for Service Products 310.1.

- i** When the vehicle is first delivered, it is filled with a coolant mixture that ensures adequate antifreeze and anti-corrosion protection.
- i** The coolant is checked with every maintenance interval at a qualified specialist workshop.

Filling capacities

| Model | Capacity |
|------------|---------------------------|
| All models | Approx. 8.2 US qt (7.8 l) |

Windshield washer system

Important safety notes

WARNING

Windshield washer concentrate could ignite if it comes into contact with hot engine components or the exhaust system. There is a risk of fire and injury.

Make sure that no windshield washer concentrate is spilled next to the filler neck.

- !** Only MB SummerFit and MB WinterFit washer fluid should be mixed together. The spray nozzles may otherwise become blocked.

Do not use distilled or de-ionized water. Otherwise, the level sensor may give a false reading. When handling washer fluid, observe the important safety notes on service products (▷ page 295).

At temperatures above freezing:

- ▶ Fill the washer fluid reservoir with a mixture of water and windshield washer fluid, e.g. MB SummerFit.

Add 1 part MB SummerFit to 100 parts water.

At temperatures below freezing:

- ▶ Fill the washer fluid reservoir with a mixture of water and washer fluid, e.g. MB WinterFit.

For the correct mixing ratio refer to the information on the antifreeze reservoir.

- i** Add windshield washer fluid, e.g. MB SummerFit or MB WinterFit, to the washer fluid all year round.

Climate control system refrigerant

Important safety notes

The climate control system of your vehicle is filled with refrigerant R-134a.

The instruction label regarding the refrigerant type used can be found on the left, on the underside of the hood.

- !** Only the refrigerant R-134a and the PAG oil approved by Mercedes-Benz may be used. The approved PAG oil may not be mixed with any other PAG oil that is not approved for R-134a refrigerant. Otherwise, the climate control system may be damaged.

Service work, such as refilling with refrigerant or replacing component parts, may only be carried out by a qualified specialist workshop. All applicable regulations, as well as SAE standard J639, must be adhered to.

Always have work on the climate control system carried out at a qualified specialist workshop.

Refrigerant instruction label

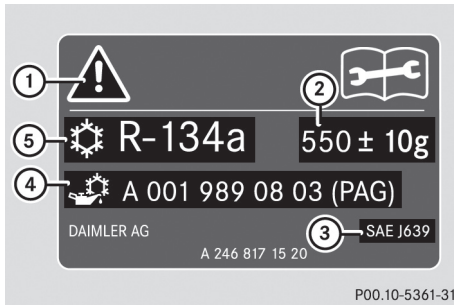

Example: refrigerant instruction label

- ① Symbol
- ② Refrigerant filling capacity
- ③ Applicable standards
- ④ PAG oil part number
- ⑤ Type of refrigerant

Warning symbol ① advises you about:

- Possible dangers
- Having service work carried out at a qualified specialist workshop

Filling capacities

| All models | Capacity |
|-------------|-------------------------------|
| Refrigerant | 22.9 ± 0.4 oz (650 ± 10 g) |
| PAG oil | 4.2 oz (120 g) |

Vehicle data

General notes

Please note that for the specified vehicle data:

- The heights specified may vary as a result of:
 - Tires
 - Load
 - Condition of the suspension
 - Optional equipment
- Optional equipment reduces the maximum payload

Dimensions and weights



| Model | ① Maximum headroom | ② Height when opened |
|------------|--------------------------|-------------------------------|
| All models | 73.8 in (1874 mm) | 78.1 in (1985 mm) |

| All models | |
|--|-----------------------|
| Vehicle length | 173.0 in (4393 mm) |
| Vehicle width including exterior mirrors | 79.1 in (2010 mm) |
| Vehicle width without exterior mirrors | 70.31 in (1786 mm) |
| Vehicle height | 61.5 in (1562 mm) |
| Wheelbase | 106.3 in (2699 mm) |
| Turning radius | 36.1 ft (11.0 m) |
| Maximum roof load | 165 lb (75.0 kg) |