



C-Class

Operator's Manual



Mercedes-Benz

Symbols

Registered trademarks:

- Bluetooth® is a registered trademark of Bluetooth SIG Inc.
- DTS is a registered trademark of DTS, Inc.
- Dolby and MLP are registered trademarks of DOLBY Laboratories.
- BabySmart™, ESP® and PRE-SAFE® are registered trademarks of Daimler AG.
- HomeLink® is a registered trademark of Johnson Controls.
- iPod® and iTunes® are registered trademarks of Apple Inc.
- Logic7® is a registered trademark of Harman International Industries.
- Microsoft® and Windows media® are registered trademarks of Microsoft Corporation.
- SIRIUS is a registered trademark of Sirius XM Radio Inc.
- HD Radio is a registered trademark of iBiquity Digital Corporation.
- Gracenote® is a registered trademark of Gracenote, Inc.
- ZAGATSurvey® and related brands are registered trademarks of ZagatSurvey, LLC.

In this Operator's Manual you will find the following symbols:

WARNING

Warning notes make you aware dangers which could pose a threat to your health or life, or to the health and life of others.

Environmental note

Environmental notes provide you with information on environmentally aware actions or disposal.

- ! Notes on material damage alert you to dangers that could lead to damage to your vehicle.

- i Practical tips or further information that could be helpful to you.

▶ This symbol indicates an instruction that must be followed.

▶ Several of these symbols in succession indicate an instruction with several steps.

(▷ page) This symbol tells you where you can find more information about a topic.

▷▷ This symbol indicates a warning or an instruction that is continued on the next page.

Display This font indicates a display in the multifunction display/COMAND display.

Parts of the software in the vehicle are protected by copyright © 2005 The FreeType Project <http://www.freetype.org>. All rights reserved.

Publication details

Internet

Further information about Mercedes-Benz vehicles and about Daimler AG can be found on the following websites:

<http://www.mbusa.com> (USA only)

<http://www.mercedes-benz.ca> (Canada only)

Editorial office

©Daimler AG: Not to be reprinted, translated or otherwise reproduced, in whole or in part, without written permission from Daimler AG.

Vehicle manufacturer

Daimler AG
Mercedesstraße 137
70327 Stuttgart
Germany

Welcome to the world of Mercedes-Benz

We urge you to read this Operator's Manual carefully and familiarize yourself with the vehicle before driving. For your own safety and a longer vehicle life, follow the instructions and warning notices in this manual. Ignoring them could result in damage to the vehicle or personal injury to you or others.

Vehicle damage caused by failure to follow instructions is not covered by the Mercedes-Benz Limited Warranty.

The equipment or product designation of your vehicle may vary depending on:

- Model
- Order
- Country specification
- Availability

Mercedes-Benz therefore reserves the right to introduce changes in the following areas:

- Design
- Equipment
- Technical features

The equipment in your vehicle may therefore differ from that shown in the descriptions and illustrations.

The following are integral components of the vehicle:

- Operator's Manual
- Maintenance Booklet
- Equipment-dependent supplements

Keep printed copies of the documents in the vehicle at all times. If you sell the vehicle, always pass the documents on to the new owner.

The technical documentation team at Daimler AG wishes you safe and pleasant motoring.

Mercedes-Benz USA, LLC
Mercedes-Benz Canada, Inc.
A Daimler Company

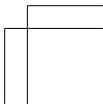
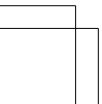
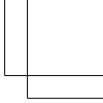
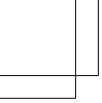

Index 4

Introduction 21

At a glance 29

Safety 39

Opening and closing 75

Seats, steering wheel and mirrors 97

Lights and windshield wipers 113

Climate control 129

Driving and parking 145

On-board computer and displays 203

Stowage and features 261

Maintenance and care 285

Breakdown assistance 299

Wheels and tires 313

Technical data 349

- 1, 2, 3 ...**
- 115 V socket** 271
- 12 V socket**
see Sockets
- 4MATIC (permanent four-wheel drive)** 185
- A**
- ABS (Anti-lock Braking System)**
Display message 223
Function/notes 65
Important safety notes 65
Warning lamp 250
- Activating/deactivating cooling with air dehumidification** 135
- Active Blind Spot Assist**
Activating/deactivating (on-board computer) 214
Display message 238
Function/information 196
- Active Driving Assistance package** . 196
- Active Lane Keeping Assist**
Activating/deactivating (on-board computer) 214
Display message 237
Function/information 199
- Active light function** 117
- ADAPTIVE BRAKE** 71
- Adaptive Highbeam Assist**
Display message 233
Function/notes 118
Switching on/off 118, 119
Switching on/off (on-board computer) 216
- Additives (engine oil)** 355
- Air bags**
Display message 229
Front air bag (driver, front passenger) 44
Important safety notes 42
Knee bag 44
PASSENGER AIR BAG OFF indicator lamp 47
Pelvis air bag 46
Safety guidelines 41
Side impact air bag 45
Window curtain air bag 46
- Air-conditioning system**
see Climate control
- AIR FLOW** 137
- Air vents**
Glove box 143
Important safety notes 142
Rear 143
Setting 142
Setting the center air vents 142
Setting the side air vents 142
- Alarm system**
see ATA (Anti-Theft Alarm system)
- AMG menu (on-board computer)** 219
- Anti-lock braking system**
see ABS (Anti-lock Braking System)
- Anti-theft alarm system**
see ATA (Anti-Theft Alarm system)
- Ashtray** 269
- Assistance display (on-board computer)** 213
- Assistance menu (on-board computer)** 213
- ASSYST PLUS**
Displaying a service message 286
Hiding a service message 286
Notes 286
Resetting the service interval display 286
Service message 286
Special service requirements 287
- ATA (Anti-Theft Alarm system)**
Activating/deactivating 73
Function 73
Switching off the alarm 73
- ATTENTION ASSIST**
Activating/deactivating 214
Display message 236
Function/notes 192
- Audio menu (on-board computer)** 210
- Audio system**
see separate operating instructions
- Authorized Centers**
see Qualified specialist workshop

- Authorized Mercedes-Benz Center**
see Qualified specialist workshop
- Authorized workshops**
see Qualified specialist workshop
- AUTO lights**
Display message 232
see Lights
- Automatic engine start (ECO start/
stop function)** 151
- Automatic engine switch-off (ECO
start/stop function)** 151
- Automatic headlamp mode** 115
- Automatic transmission**
Automatic drive program 157
Changing gear 156
Display message 244
Driving tips 156
Emergency running mode 161
Kickdown 156
Manual drive program 159
Overview 154
Problem (malfunction) 161
Program selector button 156
Pulling away 150
Releasing the parking lock
manually 161
Selector lever 154
Shift ranges 158
Starting the engine 149
Steering wheel paddle shifters 157
Transmission position display 155
Transmission positions 155
- Automatic transmission
emergency mode** 161
- B**
- Backup lamp**
Changing bulbs 124
Display message 232
- Bag hook** 266
- BAS (Brake Assist System)** 66
- BAS PLUS (Brake Assist System
PLUS)** 66
- Battery (SmartKey)**
Checking 79
Important safety notes 78
Replacing 79
- Battery (vehicle)**
Charging 304
Display message 235
Important safety notes 302
Jump starting 306
- Blind Spot Assist**
Activating/deactivating 214
Display message 238
Notes/function 193
see Active Blind Spot Assist
- Brake Assist**
see BAS (Brake Assist System)
- Brake fluid**
Display message 225
Notes 355
- Brake lamps**
Changing bulbs 124
Display message 231
- Brakes**
ABS 65
BAS 66
BAS PLUS 66
Brake fluid (notes) 355
Display message 223
Driving tips 168
High-performance brake system 170
Important safety notes 168
Maintenance 169
Parking brake 165
Warning lamp 250
- Breakdown**
see Flat tire
see Towing away/tow-starting
- Bulbs**
see Replacing bulbs
- C**
- California**
Important notice for retail
customers and lessees 23
- Calling up a malfunction**
see Display messages
- Car**
see Vehicle
- Care**
Carpets 297
Car wash 292

- Display 296
- Exterior lights 295
- Gear or selector lever 296
- Interior 296
- Matte finish 294
- Notes 291
- Paint 293
- Plastic trim 296
- Power washer 293
- Rear view camera 295
- Roof lining 297
- Seat belt 297
- Seat cover 297
- Sensors 295
- Steering wheel 296
- Tail pipes 296
- Trim pieces 296
- Washing by hand 292
- Wheels 293
- Windows 294
- Wiper blades 294
- Wooden trim 296
- Cargo tie down rings** 265
- Car wash (care)** 292
- CD player/CD changer (on-board computer)** 211
- Center console**
 - Lower section 35
 - Upper section 34
- Central locking**
 - Automatic locking (on-board computer) 217
 - Locking/unlocking (SmartKey) 76
- Changing bulbs**
 - Brake lamps 124
 - Cornering light function 123
 - High-beam headlamps 122
 - Low-beam headlamps 122
 - Parking lamps 123
 - Reversing lamps 124
 - Standing lamps (front) 123
- Child-proof locks**
 - Important safety notes 64
 - Rear doors 64
- Children**
 - In the vehicle 59
 - Restraint systems 59
 - Special seat belt retractor 61
- Child seat**
 - LATCH-type (ISOFIX) child seat anchors 62
 - Top Tether 63
- Cigarette lighter** 270
- Cleaning**
 - Mirror turn signal 295
- Climate control**
 - Adjusting the airflow (AIR FLOW) ... 137
 - Automatic climate control (3-zone) 134
 - Controlling automatically 137
 - Cooling with air dehumidification . . 135
 - Defrosting the windows 140
 - Defrosting the windshield 139
 - Dual-zone automatic climate control 131
 - Important safety notes 130
 - Indicator lamp 137
 - Maximum cooling 140
 - Notes on using automatic climate control 135
 - Notes on using dual-zone automatic climate control 132
 - Overview of systems 130
 - Problems with cooling with air dehumidification 137
 - Problem with the rear window defroster 141
 - Rear control panel 134
 - Refrigerant 357
 - Refrigerant filling capacity 358
 - Setting the air distribution 138
 - Setting the airflow 139
 - Setting the air vents 142
 - Setting the temperature 138
 - Switching air-recirculation mode on/off 141
 - Switching on/off 135
 - Switching residual heat on/off 141
 - Switching the rear window defroster on/off 140
 - Switching the ZONE function on/off 139
- Cockpit**
 - Overview 30
 - see Instrument cluster
- COMAND**
 - see separate operating instructions

- Combination switch** 116
 - Consumption statistics (on-board computer)** 207
 - Convenience closing feature** 89
 - Convenience opening feature** 89
 - Coolant (engine)**
 - Checking the level 290
 - Display message 233
 - Filling capacity 357
 - Important safety notes 356
 - Temperature (on-board computer) . 219
 - Temperature gauge 204
 - Warning lamp 257
 - Cooling**
 - see Climate control
 - Copyright** 27
 - Cornering light function**
 - Changing bulbs 123
 - Display message 230
 - Function/notes 118
 - Crash-responsive emergency lighting** 121
 - Cruise control**
 - Cruise control lever 172
 - Deactivating 173
 - Display message 241
 - Driving system 171
 - Function/notes 171
 - Important safety notes 171
 - Setting a speed 173
 - Storing and maintaining current speed 172
 - Cup holder**
 - Center console 267
 - Important safety notes 267
 - Rear compartment 268
 - Customer Assistance Center (CAC)** ... 26
 - Customer Relations Department** 26
- D**
- Dashboard**
 - see Instrument cluster
 - Dashboard lighting**
 - see Instrument cluster lighting
 - Data**
 - see Technical data
 - Daytime running lamps**
 - Display message 232
 - Switching on/off (on-board computer) 216
 - Switching on/off (switch) 115
 - Dealerships**
 - see Qualified specialist workshop
 - Declarations of conformity** 25
 - Delayed switch-off**
 - Exterior lighting (on-board computer) 216
 - Interior lighting 217
 - Diagnostics connection** 25
 - Digital speedometer** 208
 - Display (cleaning instructions)** 296
 - Display messages**
 - ASSYST PLUS 286
 - Calling up (on-board computer) 222
 - Driving systems 236
 - Engine 233
 - General notes 222
 - Hiding (on-board computer) 222
 - KEYLESS-GO 246
 - Lights 230
 - Safety systems 223
 - SmartKey 246
 - Tires 242
 - Vehicle 244
 - Distance recorder** 207
 - see Odometer
 - see Trip odometer
 - Distance warning (warning lamp)** 259
 - DISTRONIC PLUS**
 - Activation conditions 175
 - Deactivating 179
 - Display message 239
 - Displays in the multifunction display 179
 - Driving tips 180
 - Function/notes 173
 - Important safety notes 173
 - Setting the specified minimum distance 178
 - Warning lamp 259
 - Doors**
 - Automatic locking (on-board computer) 217
 - Automatic locking (switch) 83

- Central locking/unlocking (SmartKey) 76
- Control panel 37
- Display message 245
- Emergency locking 83
- Emergency unlocking 83
- Important safety notes 81
- Opening (from inside) 82
- Drinking and driving** 167
- Drinks holder**
see Cup holder
- Drive program**
 - Automatic 157
 - Display 155
 - Manual 159
 - SETUP (on-board computer) 219
- Drive program selector** 157
- Driver's door**
see Doors
- Driving abroad**
 - Mercedes-Benz Service 287
 - Symmetrical low beam 114
- Driving lamps**
see Daytime running lamps
- Driving on flooded roads** 170
- Driving safety systems**
 - ABS (Anti-lock Braking System) 65
 - ADAPTIVE BRAKE 71
 - BAS (Brake Assist System) 66
 - BAS PLUS (Brake Assist System PLUS) 66
 - Electronic brake force distribution ... 70
 - ESP® (Electronic Stability Program) 67, 68
 - ETS/4ETS (Electronic Traction System) 67
 - Important safety information 65
 - Overview 65
 - PRE-SAFE® Brake 71
- Driving systems**
 - Active Blind Spot Assist 196
 - Active Driving Assistance package 196
 - Active Lane Keeping Assist 199
 - ATTENTION ASSIST 192
 - Blind Spot Assist 193
 - Cruise control 171
 - Display message 236
 - DISTRONIC PLUS 173
 - Dynamic handling package with sports mode 181
 - HOLD function 182
 - Lane Keeping Assist 194
 - Lane Tracking package 192
 - Parking Guidance 188
 - PARKTRONIC 185
 - RACE START (AMG vehicles) 183
 - Rear view camera 191
- Driving tips**
 - Automatic transmission 156
 - Brakes 168
 - Break-in period 146
 - DISTRONIC PLUS 180
 - Downhill gradient 168
 - Drinking and driving 167
 - Driving abroad 114
 - Driving in winter 171
 - Driving on flooded roads 170
 - Driving on wet roads 170
 - Exhaust check 167
 - Fuel 166
 - General 166
 - Hydroplaning 170
 - Icy road surfaces 171
 - Limited braking efficiency on salted roads 169
 - Snow chains 317
 - Symmetrical low beam 114
 - Wet road surface 169
- DVD audio (on-board computer)** 211
- DVD video (on-board computer)** 211
- Dynamic handling package with sports mode** 181

E

- EASY-ENTRY feature**
 - Activating/deactivating 218
 - Function/notes 106
- EASY-EXIT feature**
 - Crash-responsive 107
 - Function/notes 106
 - Switching on/off 218

- EBD (electronic brake force distribution)**
 - Display message 224
 - Function/notes 70
- ECO display**
 - Function/notes 167
 - On-board computer 208
- ECO start/stop function**
 - Automatic engine start 151
 - Automatic engine switch-off 151
 - Deactivating/activating 152
 - General information 151
 - Important safety notes 151
 - Introduction 150
- Electronic Stability Program**
 - see ESP® (Electronic Stability Program)
- Emergency release**
 - Driver's door 83
 - Fuel filler flap 163
 - Trunk 86, 87
 - Vehicle 83
- Emergency spare wheel**
 - General notes 346
 - Important safety notes 346
 - Storage location 346
 - Technical data 347
- Emergency Tensioning Devices**
 - Function 58
 - Safety guidelines 41
- Emissions control**
 - Service and warranty information 22
- Engine**
 - Check Engine warning lamp 256
 - Display message 233
 - ECO start/stop function 150
 - Engine number 351
 - Irregular running 153
 - Jump-starting 306
 - Starting problems 153
 - Starting the engine with the
 - SmartKey 149
 - Starting with KEYLESS-GO 149
 - Switching off 165
 - Tow-starting (vehicle) 310
- Engine, jump starting**
 - see Jump starting (engine)
- Engine electronics**
 - Problem (malfunction) 153
- Engine oil**
 - Adding 289
 - Additives 355
 - Checking the oil level 288
 - Checking the oil level using the
 - dipstick 289
 - Display message 235
 - Filling capacity 355
 - Notes about oil grades 354
 - Notes on oil level/consumption 288
 - Temperature (on-board computer) . 219
 - Viscosity 355
- ESP® (Electronic Stability Program)**
 - AMG menu (on-board computer) ... 219
 - Deactivating/activating (AMG vehicles) 69
 - Deactivating/activating (except AMG vehicles) 213
 - Deactivating/activating (notes; except AMG vehicles) 68
 - Display message 223
 - ETS/4ETS 67
 - Function/notes 67, 68
 - Important safety information 68
 - Warning lamp 252
- ETS/4ETS (Electronic Traction System)** 67
- Exhaust check** 167
- Exhaust tail pipe (cleaning instructions)** 296
- Exterior lighting**
 - Setting options 114
 - see Lights
- Exterior mirrors**
 - Adjusting 107
 - Dipping (automatic) 109
 - Folding in/out (automatically) 108
 - Folding in/out (electrically) 108
 - Folding in when locking (on-board computer) 218
 - Out of position (troubleshooting) ... 109
 - Setting 108
 - Storing settings (memory function) 110
 - Storing the parking position 109

Eyeglasses compartment 263

F

Filler cap

see Fuel filler flap

First-aid kit 300

Flat tire

MOExtended run-flat system 301

Preparing the vehicle 301

see Emergency spare wheel

Floormats 284

Fog lamps

Switching on/off 115

Front fog lamps

Display message 231

Switching on/off 115

Fuel

Additives 353

Consumption statistics 207

Displaying the current

consumption 208

Displaying the range 208

Driving tips 166

Flexible fuel vehicles 354

Fuel gauge 31

Grade (gasoline) 353

Important safety notes 352

Notes for AMG vehicles 353

Premium-grade unleaded gasoline . 353

Problem (malfunction) 164

Refueling 162

Tank content/reserve fuel 352

Fuel filler flap

Emergency release 163

Opening/closing 162

Fuel level

Calling up the range (on-board
computer) 208

Fuel tank

Capacity 352

Problem (malfunction) 164

Fuse allocation chart (vehicle tool

kit) 300

Fuses

Allocation chart 310

Before changing 310

Dashboard fuse box 311

Fuse box in the engine

compartment 311

Fuse box in the trunk 312

Important safety notes 310

G

Garage door opener

Clearing the memory 284

Important safety notes 281

Opening/closing the garage door .. 283

Programming (button in the rear-
view mirror) 282

Gear indicator (on-board computer) 219

**Gear or selector lever (cleaning
guidelines)** 296

Genuine parts 21

Glove box 263

H

Handbrake

see Parking brake

Hazard warning lamps 117

Headlamps

Adding fluid to cleaning system 291

Cleaning system (function) 117

Cleaning system (notes) 357

Fogging up 119

see Automatic headlamp mode

Head restraints

Adjusting 101

Adjusting (electrically) 102

Adjusting (manually) 102

Adjusting (rear) 102

Installing/removing (rear) 103

Luxury 102

see NECK-PRO head restraints/
NECK-PRO luxury head restraints

Heating

see Climate control

High-beam headlamps

Changing bulbs 122

Display message 231

Switching on/off 117

Hill start assist 150

HOLD function	
Deactivating	183
Display message	237
Function/notes	182
Hood	
Closing	288
Display message	245
Important safety notes	287
Opening	288
Hydroplaning	170

I

Ignition lock	
see Key positions	
Immobilizer	72
Indicator lamps	
see Warning and indicator lamps	
Instrument cluster	
Overview	31
Settings	215
Warning and indicator lamps	32
Instrument cluster lighting	204
Interior lighting	120
Automatic control	120
Delayed switch-off (on-board computer)	217
Emergency lighting	121
Manual control	120
Overview	120
Reading lamp	120

J

Jack	
Storage location	300
Using	339
Jump starting (engine)	306

K

KEYLESS-GO	
Convenience closing feature	90
Display message	246
Locking	77
Start/Stop button	148

Starting the engine	149
Unlocking	77

Key positions

KEYLESS-GO	148
SmartKey	147

Kickdown

Driving tips	156
Manual drive program	160

Knee bag	44
-----------------------	----

L

Lamps

 see Warning and indicator lamps

Lane Keeping Assist

Activating/deactivating	214
Display message	237
Function/information	194

Lane Tracking package	192
------------------------------------	-----

Lap time (RACETIMER)	220
-----------------------------------	-----

LATCH-type (ISOFIX) child seat

anchors	62
----------------------	----

Light function, active

Display message	232
-----------------------	-----

Lighting

Light switch	114
--------------------	-----

Lights

Activating/deactivating the interior lighting delayed switch-off ..	217
Active light function	117
Automatic headlamp mode	115
Cornering light function	118
Display message	230
Driving abroad	114
Fog lamps	115
Hazard warning lamps	117
High beam flasher	117
High-beam headlamps	117
Low-beam headlamps	115
Parking lamps	116
Rear fog lamp	116
Standing lamps	116
Switching Adaptive Highbeam Assist on/off	216
Switching the daytime running lamps on/off (on-board computer) ..	216
Switching the daytime running lamps on/off (switch)	115

- Switching the exterior lighting delayed switch-off on/off (on-board computer) 216
 - Switching the surround lighting on/off (on-board computer) 216
 - Turn signals 116
 - see Interior lighting
 - see Replacing bulbs
 - Light sensor (display message)** 232
 - Loading guidelines** 262
 - Locking**
 - see Central locking
 - Locking (doors)**
 - Automatic 83
 - Emergency locking 83
 - From inside (central locking button) 82
 - Locking centrally**
 - see Central locking
 - Locking verification signal (on-board computer)** 217
 - Low-beam headlamps**
 - Changing bulbs 122
 - Display message 230
 - Setting for driving abroad (symmetrical) 114
 - Switching on/off 115
 - Lumbar support**
 - Adjusting 103
 - Adjusting the 4-way lumbar support 103
 - Luxury head restraints** 102
- M**
- M+S tires** 316
 - Malfunction message**
 - see Display messages
 - Matte finish (cleaning instructions)** 294
 - mbrace**
 - Call priority 277
 - Display message 225
 - Downloading destinations (COMAND) 277
 - Downloading routes 280
 - Emergency call 274
 - General notes 273
 - Geo fencing 281
 - Locating a stolen vehicle 279
 - MB info call button 276
 - Remote vehicle locking 278
 - Roadside Assistance button 276
 - Search & Send 278
 - Self-test 274
 - Speed alert 280
 - System 274
 - Triggering the vehicle alarm 281
 - Vehicle remote malfunction diagnosis 279
 - Vehicle remote unlocking 278
 - Mechanical key**
 - Function/notes 78
 - Locking vehicle 83
 - Unlocking the driver's door 83
 - Memory card (audio)** 211
 - Memory function** 110
 - Message memory (on-board computer)** 222
 - Messages**
 - see Display messages
 - Mirrors**
 - see Exterior mirrors
 - see Rear-view mirror
 - see Vanity mirror (in the sun visor)
 - Mobile phone**
 - Menu (on-board computer) 211
 - Modifying the programming (SmartKey)** 77
 - MOExtended run-flat system** 301
 - Mounting wheels**
 - Lowering the vehicle 342
 - Mounting a new wheel 341
 - Preparing the vehicle 338
 - Raising the vehicle 339
 - Removing a wheel 341
 - Securing the vehicle against rolling away 339
 - MP3**
 - Operation 211
 - see separate operating instructions
 - Multifunction display**
 - Function/notes 206
 - Permanent display 216
 - Multifunction steering wheel**
 - Operating the on-board computer . 205
 - Overview 33

N**Navigation**

- Menu (on-board computer) 209
- see separate operating instructions

NECK-PRO head restraints

- Operation 52
- Resetting after being triggered 53

NECK-PRO luxury head restraints

- Operation 52
- Resetting after being triggered 53

Notes on breaking-in a new vehicle 146**O****Occupant Classification System****(OCS)**

- Faults 51
- Operation 47
- System self-test 49

Occupant safety

- Children in the vehicle 59
- System overview 40

OCS

- Faults 51
- Operation 47
- System self-test 49

Odometer 207**Oil**

- see Engine oil

On-board computer

- AMG menu 219
- Assistance menu 213
- Audio menu 210
- Convenience submenu 218
- Displaying a service message 286
- Display messages 222
- DISTRONIC PLUS 179
- Factory settings submenu 219
- Important safety notes 204
- Instrument cluster submenu 215
- Lighting submenu 216
- Menu overview 207
- Message memory 222
- Navigation menu 209
- Operation 205
- RACETIMER 220
- Service menu 215

- Settings menu 215
- Standard display 207
- Telephone menu 211
- Trip menu 207
- Vehicle submenu 217
- Video DVD operation 211

Opening and closing the side trim**panels** 123**Operating safety**

- Declaration of conformity 25
- Important safety notes 24

Operating system

- see On-board computer

Operator's Manual

- Vehicle equipment 22

Outside temperature display 205**Overhead control panel** 36**Override feature**

- Rear side windows 64

P**Paint code number** 350**Paintwork (cleaning instructions)** ... 293**Panic alarm** 40**Panorama roof with power tilt/
sliding panel**

- Opening/closing 93
- Opening/closing the roller
sunblind 94
- Problem (malfunction) 94
- Resetting 94

Panorama sliding sunroof

- Important safety notes 91

Parking 164

- Important safety notes 164
- Parking brake 165
- Position of exterior mirror, front-
passenger side 109
- Rear view camera 191
- see PARKTRONIC

Parking aid

- Parking Guidance 188
- see Exterior mirrors
- see PARKTRONIC

Parking brake

- Display message 224
- Notes/function 165

- Parking Guidance**
 - Display message 238
 - Important safety notes 188
 - Parking lamps**
 - Changing bulbs 123
 - Switching on/off 116
 - PARKTRONIC**
 - Deactivating/activating 187
 - Driving system 185
 - Function/notes 185
 - Important safety notes 185
 - Problem (malfunction) 188
 - Range of the sensors 186
 - Warning display 186
 - PASSENGER AIR BAG OFF**
 - Problem (malfunction) 51
 - Problems (malfunction) 229
 - PASSENGER AIR BAG OFF indicator lamp** 47
 - Plastic trim (cleaning instructions)** . 296
 - Power washers** 293
 - Power windows**
 - see Side windows
 - PRE-SAFE® (anticipatory occupant protection)**
 - Display message 225
 - Operation 52
 - PRE-SAFE® Brake**
 - Activating/deactivating 214
 - Display message 226
 - Function/notes 71
 - Warning lamp 259
 - Program selector button** 156
 - Protection of the environment**
 - General notes 21
 - Pulling away**
 - Automatic transmission 150
- Q**
- Qualified specialist workshop** 25
- R**
- RACE START (AMG vehicles)** 183
 - RACETIMER (on-board computer)** 220
 - Radar sensor system**
 - Activating/deactivating 218
 - Display message 237
 - Radio**
 - Selecting a station 210
 - see separate operating instructions
 - Radio-wave reception/transmission in the vehicle**
 - Declaration of conformity 25
 - Reading lamp** 120
 - Rear compartment**
 - Setting the airflow 139
 - Setting the air vents 143
 - Rear fog lamp**
 - Display message 231
 - Switching on/off 116
 - Rear seats**
 - Display message 245
 - Folding the backrest forwards/back 265
 - Rear view camera**
 - Cleaning instructions 295
 - Function/notes 191
 - Rear-view mirror**
 - Anti-glare (manual) 107
 - Dipping (automatic) 109
 - Rear window blind** 269
 - Rear window defroster**
 - Problem (malfunction) 141
 - Switching on/off 140
 - Refrigerant (air-conditioning system)**
 - Important safety notes 357
 - Refueling**
 - Fuel gauge 31
 - Important safety notes 162
 - Notes for AMG vehicles 353
 - Refueling process 162
 - see Fuel
 - Releasing the parking lock manually (automatic transmission)** 161
 - Remote control**
 - Garage door opener 281
 - Programming (garage door opener) 282
 - Replacing bulbs**
 - Important safety notes 121
 - Overview of bulb types 121

- Reporting safety defects** 26
- Reserve (fuel tank)**
see Fuel
- Reserve fuel**
Display message 236
Warning lamp 256
see Fuel
- Residual heat (climate control)** 141
- Restraint system**
see SRS (Supplemental Restraint System)
- Reverse gear**
Engaging (automatic transmission) 154
- Reversing feature**
Panorama sliding sunroof 91
Roller sunblinds 93
Side windows 88
Sliding sunroof 91
Trunk lid 84
- Roadside Assistance (breakdown)** 23
- Roller blind**
see Roller sunblind
- Roller sunblind**
Panorama roof with power tilt/
sliding panel 93
Rear side windows 269
Rear window 269
- Roof carrier** 267
- Roof lining and carpets (cleaning guidelines)** 297
- Roof load (maximum)** 358
- Route (navigation)**
see Route guidance (navigation)
- Route guidance (navigation)** 209
- S**
- Safety**
Children in the vehicle 59
Child restraint systems 59
Occupant Classification System (OCS) 47
Overview of occupant safety systems 40
- Safety system**
see Driving safety systems
- Seat belts**
Adjusting the driver's and front-passenger seat belt 56
Adjusting the height 56
Belt force limiters 58
Cleaning 297
Correct usage 55
Emergency Tensioning Devices 58
Fastening 56
Important safety guidelines 54
Releasing 57
Safety guidelines 41
Switching belt adjustment on/off (on-board computer) 218
Warning lamp 248
Warning lamp (function) 57
- Seats**
Adaptive seat backrests (AMG vehicles) 103
Adjusting (electrically) 100
Adjusting (manually and electrically) 100
Adjusting lumbar support 103
Adjusting the 4-way lumbar support 103
Adjusting the head restraint 101
Cleaning the cover 297
Correct driver's seat position 98
Important safety notes 99
Seat heating problem 105
Seat ventilation problem 105
Storing settings (memory function) 110
Switching seat heating on/off 104
Switching seat ventilation on/off . . 105
- Sensors (cleaning instructions)** 295
- Service menu (on-board computer)** . 215
- Service products**
Brake fluid 355
Coolant (engine) 356
Engine oil 354
Fuel 351
Important safety notes 351
Refrigerant (air-conditioning system) 357
Washer fluid 357
- Service work**
see ASSYST PLUS

- Settings**
 - Factory (on-board computer) 219
 - On-board computer 215
- Setting the air distribution** 138
- Setting the airflow** 139
- SETUP (on-board computer)** 219
- Side impact air bag** 45
- Side marker lamp (display message)** 232
- Side windows**
 - Cleaning 294
 - Convenience closing feature 89
 - Convenience opening feature 89
 - Important safety information 87
 - Opening/closing 88
 - Problem (malfunction) 90
 - Resetting 90
- Sliding sunroof**
 - Important safety notes 91
 - Opening/closing 92
 - Problem (malfunction) 94
 - Resetting 92
 - see Panorama roof with power tilt/sliding panel
- SmartKey**
 - Changing the battery 79
 - Changing the programming 77
 - Checking the battery 79
 - Convenience closing feature 89
 - Convenience opening feature 89
 - Display message 246
 - Door central locking/unlocking 76
 - Important safety notes 76
 - Loss 80
 - Mechanical key 78
 - Positions (ignition lock) 147
 - Problem (malfunction) 80
 - Starting the engine 149
- Snow chains** 317
- Sockets**
 - General notes 271
 - Rear compartment 271
- Spare wheel**
 - Storage location 346
- Specialist workshop** 25
- Special seat belt retractor** 61
- Speed, controlling**
 - see Cruise control
- Speedometer**
 - Digital 208
 - In the Instrument cluster 31
 - Segments 205
 - Selecting the unit of measurement 215
 - see Instrument cluster
- SPORT handling mode**
 - Activating/deactivating (AMG vehicles) 69
 - Warning lamp 253
- SRS**
 - see SRS (Supplemental Restraint System)
- SRS (Supplemental Restraint System)**
 - Display message 226
 - Introduction 41
 - Warning lamp 255
 - Warning lamp (function) 41
- Standing lamps**
 - Changing bulbs 123
 - Display message 231
 - Switching on/off 116
- Start/stop function**
 - see ECO start/stop function
- Starting (engine)** 149
- Steering (display message)** 246
- Steering wheel**
 - Adjusting (electrically) 106
 - Adjusting (manually) 106
 - Button overview 33
 - Buttons (on-board computer) 205
 - Cleaning 296
 - Important safety notes 105
 - Paddle shifters 157
 - Storing settings (memory function) 110
- Steering wheel paddle shifters** 157
- Stopwatch (RACETIMER)** 220
- Stowage areas** 262
- Stowage compartments**
 - Armrest (under) 263
 - Cup holders 267
 - Eyeglasses compartment 263
 - Glove box 263
 - Important safety information 262
 - Rear 264

- Stowage net 264
 - Under driver's seat/front-passenger seat 264
 - Stowage net** 264
 - Stowage well beneath the trunk floor** 266
 - Summer opening**
see Convenience opening feature
 - Summer tires** 316
 - Sun visor** 268
 - Surround lighting (on-board computer)** 216
 - Switching air-recirculation mode on/off** 141
 - Switching off the alarm (ATA)** 73
- T**
- Tachometer** 205
 - Tail lamps**
Display message 231
 - Tank content**
Fuel gauge 31
 - Technical data**
Capacities 351
Emergency spare wheel 347
Information 350
Tires/wheels 342
Vehicle data 358
 - TELEAID**
Call priority 277
Downloading destinations (COMAND) 277
Downloading routes 280
Emergency call 274
Geo fencing 281
Locating a stolen vehicle 279
MB info call button 276
Remote vehicle locking 278
Roadside Assistance button 276
Search & Send 278
Self-test 274
Speed alert 280
System 274
Triggering the vehicle alarm 281
Vehicle remote malfunction diagnosis 279
Vehicle remote unlocking 278
 - Tele Aid**
General notes 273
 - Telephone**
Accepting a call 212
Display message 246
Menu (on-board computer) 211
Number from the phone book 212
Redialing 212
Rejecting/ending a call 212
 - Temperature**
Coolant 204
Coolant (on-board computer) 219
Engine oil (on-board computer) 219
Outside temperature 205
Setting (climate control) 138
 - Theft deterrent systems**
ATA (Anti-Theft Alarm system) 73
Immobilizer 72
 - Through-loading feature** 264
 - Time**
see separate operating instructions
 - Timing (RACETIMER)** 220
 - Tire pressure**
Calling up (on-board computer) 322
Checking manually 321
Display message 242
Important safety notes 322
Maximum 320
Notes 319
Pressure loss warning 321
Recommended 318
 - Tire pressure loss warning system**
General notes 321
Important safety notes 321
Restarting 322
 - Tire pressure monitoring system**
Checking the tire pressure electronically 324
Function/notes 322
General notes 322
Important safety notes 323
Restarting 325
Warning lamp 260
Warning message 325
 - Tires**
Aspect ratio (definition) 337

- Average weight of the vehicle
- occupants (definition) 335
- Bar (definition) 335
- Changing a wheel 338
- Characteristics 335
- Checking 315
- Definition of terms 335
- Direction of rotation 338
- Display message 242
- Distribution of the vehicle
- occupants (definition) 337
- DOT, Tire Identification Number (TIN) 334
- DOT (Department of Transportation) (definition) 335
- GAWR (Gross Axle Weight Rating) (definition) 336
- GVW (Gross Vehicle Weight) (definition) 336
- GVWR (Gross Vehicle Weight Rating) (definition) 336
- Important safety notes 314
- Increased vehicle weight due to optional equipment (definition) 335
- Kilopascal (kPa) (definition) 336
- Labeling (overview) 331
- Load bearing index (definition) 337
- Load index 334
- Load index (definition) 336
- M+S tires 316
- Maximum loaded vehicle weight (definition) 336
- Maximum load on a tire (definition) 336
- Maximum permissible tire pressure (definition) 336
- Maximum tire load 329
- Maximum tire load (definition) 336
- MOExtended tires 301
- Optional equipment weight (definition) 337
- PSI (pounds per square inch) (definition) 336
- Replacing 338
- Service life 316
- Sidewall (definition) 337
- Speed rating (definition) 336
- Storing 338
- Structure and characteristics (definition) 335
- Summer tires 316
- Temperature 331
- TIN (Tire Identification Number) (definition) 337
- Tire bead (definition) 337
- Tire pressure (definition) 337
- Tire pressures (recommended) 335
- Tire size (data) 342
- Tire size designation, load-bearing capacity, speed rating 332
- Tire tread 315
- Tire tread (definition) 337
- Total load limit (definition) 337
- Traction 330
- Traction (definition) 337
- Tread wear 330
- Uniform Tire Quality Grading Standards 330
- Uniform Tire Quality Grading Standards (definition) 335
- Unladen weight (definition) 336
- Wear indicator (definition) 337
- Wheel rim (definition) 335
- see Flat tire
- Top Tether** 63
- Towing**
- Important safety guidelines 308
- Installing the towing eye 309
- Removing the towing eye 309
- With the rear axle raised 309
- Towing away**
- With both axles on the ground 309
- Tow-starting**
- Emergency engine starting 310
- Important safety notes 308
- Transfer case** 161
- Transmission**
- see Automatic transmission
- Transporting the vehicle** 310
- Trim pieces (cleaning instructions)** . 296
- Trip computer (on-board computer)** 207
- Trip odometer**
- Calling up 207
- Resetting (on-board computer) 208

- Trunk**
 - Emergency release 86, 87
 - Important safety notes 84
 - Locking separately 86
 - Opening (automatically from inside) 86
 - Opening (automatically from outside) 85
 - Trunk lid**
 - Display message 245
 - Opening/closing 84
 - Opening dimensions 358
 - Trunk load (maximum)** 358
 - Turn signals**
 - Display message 230
 - Switching on/off 116
 - Type identification plate**
see Vehicle identification plate
- U**
- Unlocking**
 - Emergency unlocking 83
 - From inside the vehicle (central unlocking button) 82
- V**
- Vanity mirror (in the sun visor)** 268
 - Vehicle**
 - Correct use 26
 - Data acquisition 27
 - Display message 244
 - Emergency locking 83
 - Emergency unlocking 83
 - Equipment 22
 - Individual settings 215
 - Limited Warranty 26
 - Loading 326
 - Locking (in an emergency) 83
 - Locking (SmartKey) 76
 - Lowering 342
 - Maintenance 23
 - Parking for a long period 166
 - Pulling away 150
 - Raising 339
 - Reporting problems 26
 - Securing from rolling away 339
 - Towing away 308
 - Transporting 310
 - Unlocking (in an emergency) 83
 - Unlocking (SmartKey) 76
 - Vehicle data 358
 - Vehicle data** 358
 - Vehicle dimensions** 358
 - Vehicle emergency locking** 83
 - Vehicle identification number**
see VIN
 - Vehicle identification plate** 350
 - Vehicle tool kit** 300
 - Video (DVD)** 211
 - VIN** 350
- W**
- Warning and indicator lamps**
 - ABS 250
 - Brakes 250
 - Check Engine 256
 - Coolant 257
 - Distance warning 259
 - DISTRONIC PLUS 259
 - ESP® 252
 - ESP® OFF 253
 - Fuel tank 256
 - Overview 32
 - PASSENGER AIRBAG OFF 47
 - Reserve fuel 256
 - Seat belt 248
 - SPORT handling mode 253
 - SRS 255
 - Tire pressure monitor 260
 - Warranty** 350
 - Washer fluid**
 - Display message 246
 - Wheel bolt tightening torque** 342
 - Wheel chock** 339
 - Wheels**
 - Changing a wheel 338
 - Checking 315
 - Cleaning 293
 - Cleaning (warning) 338
 - Emergency spare wheel 346
 - Important safety notes 314
 - Interchanging/changing 338
 - Mounting a new wheel 341

Mounting a wheel	338
Removing a wheel	341
Storing	338
Tightening torque	342
Wheel size/tire size	342
Window curtain air bag	
Display message	227
Operation	46
Windows	
see Side windows	
Windshield	
Defrosting	139
Windshield washer fluid	
see Windshield washer system	
Windshield washer system	291
Notes	357
Windshield wipers	
Problem (malfunction)	127
Replacing the wiper blades	126
Switching on/off	125
Winter driving	
Important safety notes	316
Slippery road surfaces	171
Snow chains	317
Winter tires	
M+S tires	316
Wiper blades	
Cleaning	294
Important safety notes	126
Replacing (windshield)	126
Wooden trim (cleaning instructions)	296
Workshops	
see Qualified specialist workshop	

Z

ZONE function	
Switching on/off	139

Protection of the environment

General notes

Environmental note

Daimler's declared policy is one of comprehensive environmental protection.

The objectives are for the natural resources that form the basis of our existence on this planet to be used sparingly and in a manner that takes the requirements of both nature and humanity into account.

You too can help to protect the environment by operating your vehicle in an environmentally responsible manner.

Fuel consumption and the rate of engine, transmission, brake and tire wear are affected by these factors:

- operating conditions of your vehicle
- your personal driving style

You can influence both factors. You should bear the following in mind:

Operating conditions:

- avoid short trips as these increase fuel consumption.
- always make sure that the tire pressures are correct.
- do not carry any unnecessary weight.
- remove roof racks once you no longer need them.
- a regularly serviced vehicle will contribute to environmental protection. You should therefore adhere to the service intervals.
- always have service work carried out at a qualified specialist workshop.

Personal driving style:

- do not depress the accelerator pedal when starting the engine.
- do not warm up the engine when the vehicle is stationary.
- drive carefully and maintain a safe distance from the vehicle in front.
- avoid frequent, sudden acceleration and braking.

- change gear in good time and use each gear only up to $\frac{2}{3}$ of its maximum engine speed.
- switch off the engine in stationary traffic.
- keep an eye on the vehicle's fuel consumption.

Environmental concerns and recommendations

Wherever the operating instructions require you to dispose of materials, first try to regenerate or re-use them. Observe the relevant environmental rules and regulations when disposing of materials. In this way you will help to protect the environment.

Genuine Mercedes-Benz parts

Environmental note

Daimler AG also supplies reconditioned major assemblies and parts which are of the same quality as new parts. They are covered by the same Limited Warranty entitlements as new parts.

! Air bags and Emergency Tensioning Devices, as well as control units and sensors for these restraint systems, may be installed in the following areas of your vehicle:

- doors
- door pillars
- door sills
- seats
- cockpit
- instrument cluster
- center console

Do not install accessories such as audio systems in these areas. Do not carry out repairs or welding. You could impair the operating efficiency of the restraint systems.

Have aftermarket accessories installed at a qualified specialist workshop.

You could jeopardize the operating safety of your vehicle if you use parts, tires and wheels as well as accessories relevant to safety which have not been approved by Mercedes. This could lead to malfunctions in safety-relevant systems, e.g. the brake system. Use only genuine Mercedes-Benz parts or parts of equal quality. Only use tires, wheels and accessories that have been specifically approved for your vehicle.

Genuine Mercedes-Benz parts are subject to strict quality control. Every part has been specifically developed, manufactured or selected for and adapted to Mercedes-Benz vehicles. Only genuine Mercedes-Benz parts should therefore be used.

More than 300,000 different genuine Mercedes-Benz parts are available for Mercedes-Benz models.

All authorized Mercedes-Benz Centers maintain a supply of genuine Mercedes-Benz parts for necessary service and repair work. In addition, strategically located parts delivery centers provide quick and reliable parts service.

Always specify the vehicle identification number (VIN) (▷ page 350) when ordering genuine Mercedes-Benz parts.

Operator's Manual

Vehicle equipment

This Operator's Manual describes all models and all standard and optional equipment of your vehicle available at the time of going to print. Country-specific differences are possible. Bear in mind that your vehicle may not feature all functions described here. This also applies to safety-relevant systems and functions. The equipment in your vehicle may therefore differ from that shown in the descriptions and illustrations.

The original purchase agreement lists all systems installed in your vehicle.

Should you have any questions concerning equipment and operation, please consult an authorized Mercedes-Benz Center.

The Operator's Manual and Maintenance Booklet are important documents and should be kept in the vehicle.

Service and vehicle operation

Service and literature

Your vehicle is covered under the terms of the warranties printed in the Service and Warranty Information booklet. Your authorized Mercedes-Benz Center will exchange or repair any defective parts originally installed in the vehicle in accordance with the terms of the following warranties:

- New Vehicle Limited Warranty
- Emission Systems Warranty
- Emission Performance Warranty
- California, Connecticut, Maine, Massachusetts, New York, Pennsylvania, Rhode Island and Vermont Emission Control Systems Warranty
- State warranty enforcement laws (lemon laws)

Information for customers in California

Under California law you may be entitled to a replacement of your vehicle or a refund of the purchase price or lease price, if after a reasonable number of repair attempts Mercedes-Benz USA, LLC and/or its authorized repair or service facilities fail to fix one or more substantial defects or malfunctions in the vehicle that are covered by its express warranty. During the period of 18 months from original delivery of the vehicle or the accumulation of 18,000 miles (approximately 29,000 km) on the odometer of the vehicle, whichever occurs first, a reasonable number of repair attempts is presumed for a retail buyer or lessee if one or more of the following occurs:

- (1) the same substantial defect or malfunction results in a condition that is likely to cause death or serious bodily injury if the vehicle is driven, that defect or malfunction has been subject to repair two or more times, and you have directly notified Mercedes-Benz USA, LLC in writing of the need for its repair,
- (2) the same substantial defect or malfunction of a less serious nature than category (1) has been subject to repair four or more times and you have directly notified us in writing of the need for its repair, or
- (3) the vehicle is out of service by reason of repair of the same or different substantial defects or malfunctions for a cumulative total of more than 30 calendar days.

Please send your written notice to:
Mercedes-Benz USA, LLC
Customer Assistance Center
One Mercedes Drive
Montvale, NJ 07645-0350

Maintenance

The Service and Warranty Booklet describes all the necessary maintenance work which should be done at regular intervals.

Always have the Service and Warranty Booklet with you when you bring the vehicle to an authorized Mercedes-Benz Center. The service advisor will record every service for you in the Service and Warranty Booklet.

Roadside Assistance

The Mercedes-Benz Roadside Assistance Program offers technical help in the event of a breakdown. Calls to the toll-free Roadside Assistance Hotline are answered by our agents 24 hours a day, 365 days a year.

1-800-FOR-MERCEdes(1-800-367-6372) (USA)

1-800-387-0100 (Canada)

For additional information, refer to the Mercedes-Benz Roadside Assistance Program brochure (USA) or the "Roadside Assistance" section in the Service and Warranty booklet (Canada). You will find both in your vehicle literature portfolio.

Change of address or change of ownership

In the event of a change of address, please send us the "Notification of Address Change" in the Service and Guarantee booklet or simply call the Mercedes-Benz Customer Assistance Center (USA) at the hotline number

1-800-FOR-MERCEdes(1-800-367-6372) or Customer Service Center (Canada) at 1-800-387-0100. This will assist us in contacting you in a timely manner should the need arise.

If you sell your Mercedes, please leave the entire literature in the vehicle so that it is available to the next owner.

If you have purchased a used car, please send us the "Notification of Used Car Purchase" in the Service and Guarantee booklet or simply call the Mercedes-Benz Customer Assistance Center (USA) at the hotline number 1-800-FOR-MERCEdes(1-800-367-6372) or Customer Service (Canada) at 1-800-387-0100.

Vehicle operation outside the USA and Canada

If you plan to operate your vehicle in foreign countries, please be aware that:

- service facilities or replacement parts may not be readily available.
- unleaded fuel for vehicles with a catalytic converter may not be available. Leaded fuel may cause damage to the catalytic converter.
- the fuel may have a considerably lower octane rating. Unsuitable fuel can cause engine damage.

Some Mercedes-Benz models are available for delivery in Europe through our European Delivery Program. For details, consult an authorized Mercedes-Benz Center or write to one of the following addresses.

In the USA

Mercedes-Benz USA, LLC
European Delivery Department
One Mercedes Drive
Montvale, NJ 07645-0350

In Canada

Mercedes-Benz Canada, Inc.
European Delivery Department
98 Vanderhoof Avenue
Toronto, Ontario M4G 4C9

Operating safety

Important safety notes

WARNING

If you do not have the prescribed service/ maintenance work or any required repairs carried out, this can result in malfunctions or system failures. There is a risk of an accident.

Always have the prescribed service/ maintenance work as well as any required repairs carried out at a qualified specialist workshop.

WARNING

If you switch off the ignition while driving, safety-relevant functions are only available with limitations, or not at all. This could affect, for example, the power steering and the brake boosting effect. You will require considerably more effort to steer and brake. There is a risk of an accident.

Do not switch off the ignition while driving.

WARNING

Modifications to electronic components, their software as well as wiring can impair their function and/or the function of other networked components. In particular, systems relevant to safety could also be affected. As a result, these may no longer function as intended and/or jeopardize the operating safety of the vehicle. There is an increased risk of an accident and injury.

Never tamper with the wiring as well as electronic components or their software. You should have all work to electrical and electronic equipment carried out at a qualified specialist workshop.

 There is a risk of damage to the vehicle if:

- the vehicle becomes stuck, e.g. on a high curb or an unpaved road
- you drive too fast over an obstacle, e.g. a curb or a hole in the road
- a heavy object strikes the undercarriage or parts of the chassis.

In situations like this, the body, the undercarriage, chassis parts, wheels or tires could be damaged without the damage being visible. Components damaged in this way can unexpectedly fail or, in the case of an accident, no longer withstand the strain they are designed to. If the underbody paneling is damaged, combustible materials such as leaves, grass or twigs can gather between the underbody and the underbody paneling. If these materials come in contact with hot parts of the exhaust system for an extended period, they can catch fire.

Have the vehicle checked and repaired immediately at a qualified specialist workshop. If on continuing your journey you notice that driving safety is impaired, pull over and stop the vehicle immediately, paying attention to road and traffic conditions. In such cases, visit a qualified specialist workshop.

Declarations of conformity

Vehicle components which receive and/or transmit radio waves

USA: "The wireless devices of this vehicle comply with Part 15 of the FCC Rules. Operation is subject to the following two conditions: 1) These devices may not cause harmful interference, and 2) These devices must accept any interference received, including interference that may cause undesired operation. Changes or modifications not expressly approved by the party responsible for compliance could void the user's authority to operate the equipment."

Canada: "The wireless devices of this vehicle comply with Industry Canada license-exempt RSS standard(s). Operation is subject to the following two conditions: (1) These devices may not cause interference, and (2) These devices must accept any interference,

including interference that may cause undesired operation of the device."

Diagnostics connection

The diagnostics connection is only intended for the connection of diagnostic equipment at a qualified specialist workshop.

WARNING

If you connect equipment to the diagnostics connection in the vehicle, it may affect the operation of the vehicle systems. As a result, the operating safety of the vehicle could be affected. There is a risk of an accident.

Do not connect any equipment to a diagnostics connection in the vehicle.

WARNING

Objects in the driver's footwell can restrict the pedal travel or obstruct a depressed pedal. The operating and road safety of the vehicle is jeopardized. There is a risk of an accident. Make sure that all objects in the vehicle are stowed correctly, and that they cannot enter the driver's footwell. Install the floormats securely and as specified in order to ensure sufficient clearance for the pedals. Do not use loose floormats and do not place floormats on top of one another.

! If the engine is switched off and equipment on the diagnostics connection is used, the starter battery may discharge.

Connecting equipment to the diagnostics connection can lead to emissions monitoring information being reset, for example. This may lead to the vehicle failing to meet the requirements of the next emissions test during the main inspection.

Qualified specialist workshop

An authorized Mercedes-Benz Center is a qualified specialist workshop. It has the necessary specialist knowledge, tools and

qualifications to correctly carry out the work required on your vehicle. This is especially the case for work relevant to safety.

Observe the notes in the Maintenance Booklet.

Always have the following work carried out at an authorized Mercedes-Benz Center:

- work relevant to safety
- service and maintenance work
- repair work
- alterations, installation work and modifications
- work on electronic components

Correct use

If you remove any warning stickers, you or others could fail to recognize certain dangers. Leave warning stickers in position.

Observe the following information when driving your vehicle:

- the safety notes in this manual
- the Technical Data section in this manual
- traffic rules and regulations
- laws and safety standards pertaining to motor vehicles

Problems with your vehicle

If you should experience a problem with your vehicle, particularly one that you believe may affect its safe operation, we urge you to contact an authorized Mercedes-Benz Center immediately to have the problem diagnosed and rectified. If the problem is not resolved to your satisfaction, please discuss the problem again with a Mercedes-Benz Center or contact us at one of the following addresses.

In the USA

Customer Assistance Center
Mercedes-Benz USA, LLC
One Mercedes Drive
Montvale, NJ 07645-0350

In Canada

Customer Relations Department
Mercedes-Benz Canada, Inc.
98 Vanderhoof Avenue
Toronto, Ontario M4G 4C9

Reporting safety defects

USA only:

The following text is published as required of manufacturers under Title 49, Code of U.S. Federal Regulations, Part 575 pursuant to the "National Traffic and Motor Vehicle Safety Act of 1966".

If you believe that your vehicle has a defect which could cause a crash or could cause injury or death, you should immediately inform the National Highway Traffic Safety Administration (NHTSA) in addition to notifying Mercedes-Benz USA, LLC.

If NHTSA receives similar complaints, it may open an investigation, and if it finds that a safety defect exists in a group of vehicles, it may order a recall and remedy campaign. However, NHTSA cannot become involved in individual problems between you, your dealer, or Mercedes-Benz USA, LLC.

To contact NHTSA, you may call the Vehicle Safety Hotline toll-free at 1-888-327-4236 (TTY: 1-800-424-9153); go to <http://www.safercar.gov>; or write to: Administrator, NHTSA, 400 Seventh Street, SW., Washington, DC 20590.

You can also obtain other information about motor vehicle safety from

<http://www.safercar.gov>

Limited Warranty

I Follow the instructions in this manual about the proper operation of your vehicle as well as about possible vehicle damage. Damage to your vehicle that arises from culpable contraventions against these instructions is not covered either by the

Mercedes-Benz Limited Warranty or by the New or Used-Vehicle Warranty.

Data stored in the vehicle

Information about electronic data acquisition in the vehicle

(Including notice pursuant to California Code § 9951)

Please note that your vehicle is equipped with devices that can record vehicle systems data. If your vehicle is equipped with mbrace (Canada: TELE AID), data is transmitted in the event of an accident.

This information helps, for example, to test vehicle systems after an accident and to continually improve vehicle safety. Daimler AG can access these data and submit them:

- for safety research or vehicle diagnosis purposes
- with the consent of the vehicle owner
- on the instruction of prosecuting authorities
- for use in arbitration of disputes that involve Daimler AG, its subsidiaries or its sales and service organizations
- as otherwise required or permitted by law

Please check your mbrace (Canada: TELE AID) purchase agreement to find out more about data that can be recorded and transmitted by this system.

This vehicle is equipped with an event data recorder (EDR). The main purpose of an EDR is to record data that will assist in understanding how a vehicle's systems performed in certain crash or near crash-like situations, such as during air bag deployment or when hitting a road obstacle. The EDR is designed to record data related to vehicle dynamics and safety systems for a short period of time, typically 30 seconds or less.

The EDR in this vehicle is designed to record such data as:

- how various systems in your vehicle are operating
- whether or not the driver and passenger seat belts are fastened
- how far (if at all) the driver is depressing the accelerator and/or brake pedal and
- how fast the vehicle is traveling

This data can help provide a better understanding of the circumstances in which crashes and injuries occur. NOTE: EDR data is recorded by your vehicle only if a non-trivial crash situation occurs; no data is recorded by the EDR under normal driving conditions and no personal data (e.g., name, gender, age, and crash location) are recorded. However, other parties, such as law enforcement, can combine the EDR data with the type of personal identification data routinely acquired during a crash investigation.

To read data recorded by an EDR, special equipment is required, and access to the vehicle or the EDR is needed. In addition to the vehicle manufacturer, other parties, such as law enforcement, who have the special equipment, can read the information if they have access to the vehicle or the EDR.

Information on copyright

General information

Information on license for free and open-source software used in your vehicle and its electronic components is available on the following website:

<http://www.mercedes-benz.com/opensource>

Dashboard	30
Instrument cluster	31
Multifunction steering wheel	33
Center console	34
Overhead control panel	36
Door control panel	37



Dashboard

At a glance

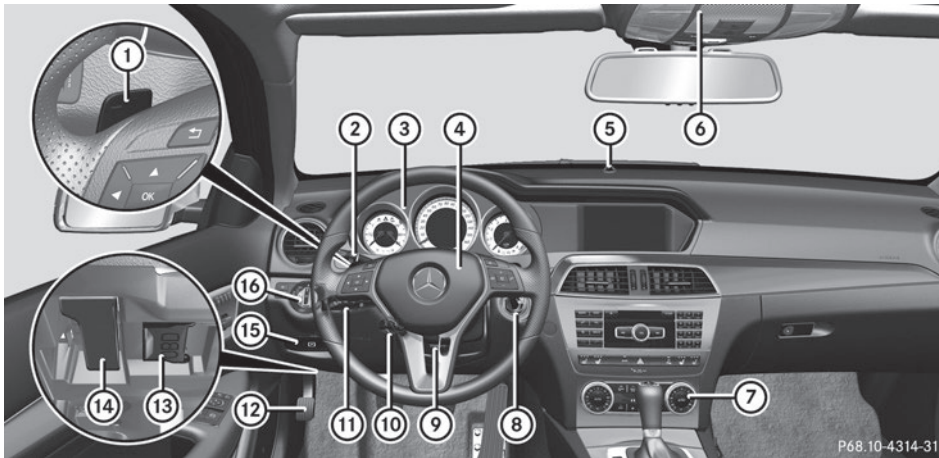

P68.10-4314-31

	Function	Page
①	Steering wheel paddle shifters	157
②	Combination switch	116
③	Instrument cluster	31
④	Horn	
⑤	PARKTRONIC warning display	185
⑥	Overhead control panel	36
⑦	Climate control systems	130
⑧	Ignition lock	147
	Start/Stop button	148

	Function	Page
⑨	Adjusting the steering wheel manually	105
⑩	Adjusting the steering wheel electrically	105
⑪	Cruise control lever	172
⑫	Parking brake	165
⑬	Diagnostics connection	25
⑭	Opening the hood	288
⑮	Releasing the parking brake	165
⑯	Light switch	114

Instrument cluster

Displays and controls

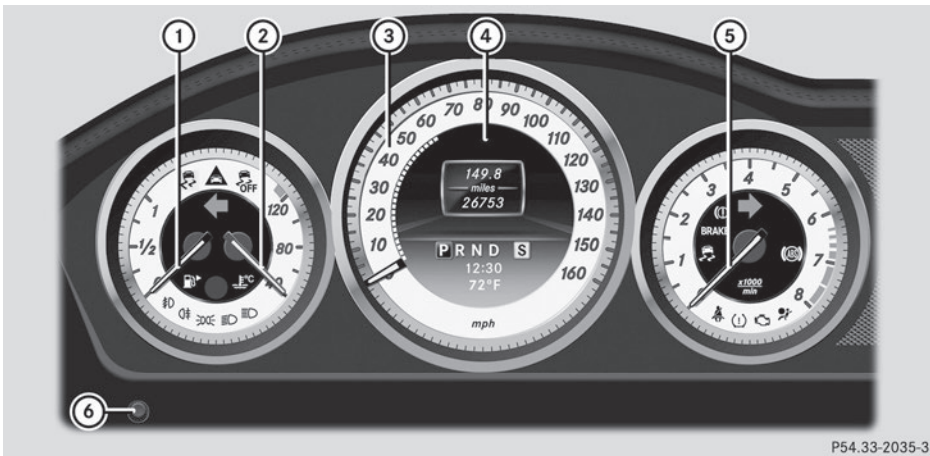

P54.33-2035-31

At a glance

	Function	Page		Function	Page
①	Fuel gauge		④	Multifunction display	206
②	Coolant temperature	204	⑤	Tachometer	205
③	Speedometer with segments	205	⑥	Instrument cluster lighting	204

Warning and indicator lamps

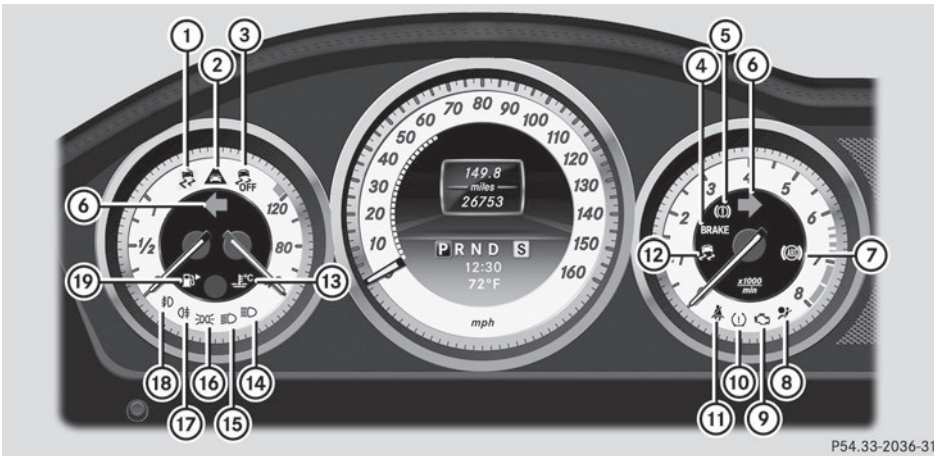

P54.33-2036-31







	Function	Page
①	ESP® SPORT handling mode in AMG vehicles	252 253
②	Distance warning	259
③	ESP® OFF	252
④	Brakes (USA only)	250
⑤	Brakes (Canada only)	250
⑥	Turn signals	116
⑦	ABS	250
⑧	SRS	255
⑨	Check Engine	256
⑩	Tire pressure monitor	260







	Function	Page
⑪	Seat belt	248
⑫	ESP® in AMG vehicles	253
⑬	Coolant	257
⑭	High-beam headlamps	117
⑮	Low-beam headlamps	115
⑯	Parking lamps	116
⑰	Rear fog lamp	116
⑱	Front fog lamps	115
⑲	Reserve fuel	256

Multifunction steering wheel



At a glance

	Function	Page
①	Multifunction display	206
②	Audio/COMAND display; see the separate operating instructions	
③	 Switches on the Voice Control System; see the separate operating instructions	
④	 Rejects or ends a call Exits phone book/redial memory  Makes or accepts a call Switches to the redial memory   Adjusts the volume  Mute	211

	Function	Page
⑤	  Selects a menu   Selects a submenu or scrolls through lists  Confirms your selection Hides display messages	205
⑥	 Back Switches off the Voice Control System; see the separate operating instructions	205



P46_10-3291-31



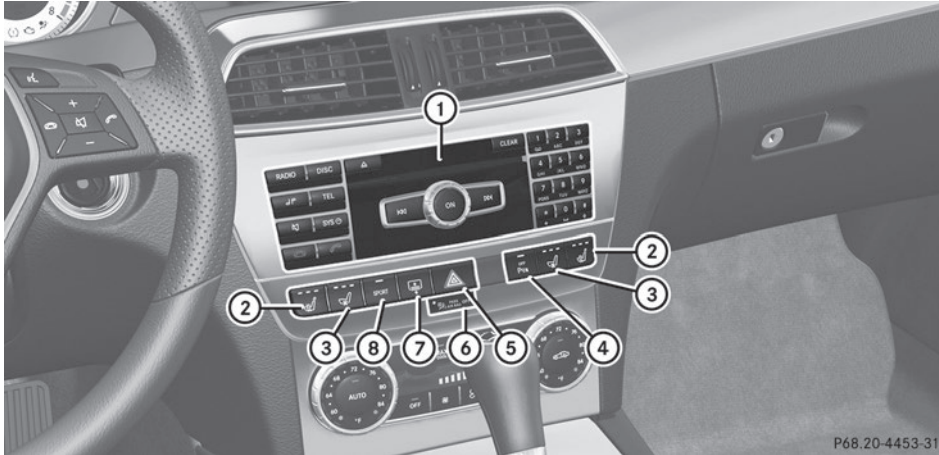

Center console

Center console, upper section



P68.20-4453-31

	Function	Page
①	Audio system/COMAND; see the separate operating instructions	
①	Audio system/COMAND; see the separate operating instructions	
②	 Seat heating	104
③	 Seat ventilation	105
④	 PARKTRONIC	185

	Function	Page
⑤	 Hazard warning lamps	117
⑥	 Indicator lamp	47
⑦	 Roller sunblind in the rear window	269
⑧	 Dynamic driving package with sports mode	181
	 AMG vehicles: ESP®	69

Center console, lower section

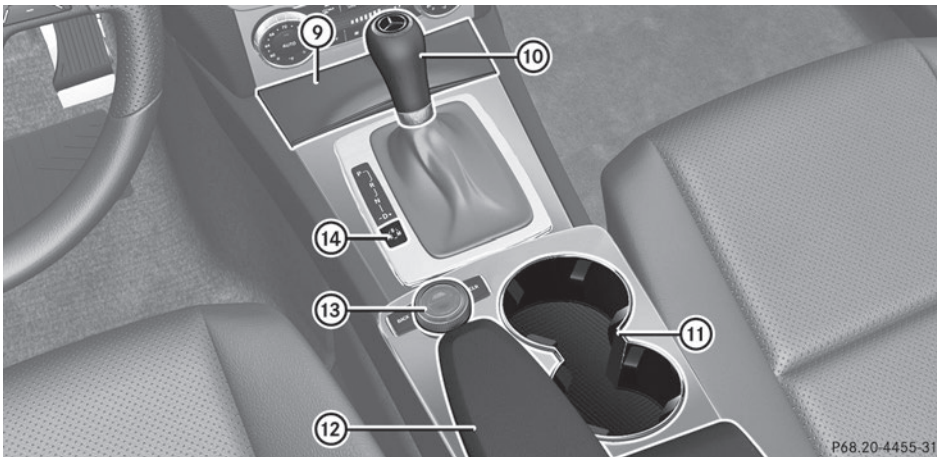

At a glance





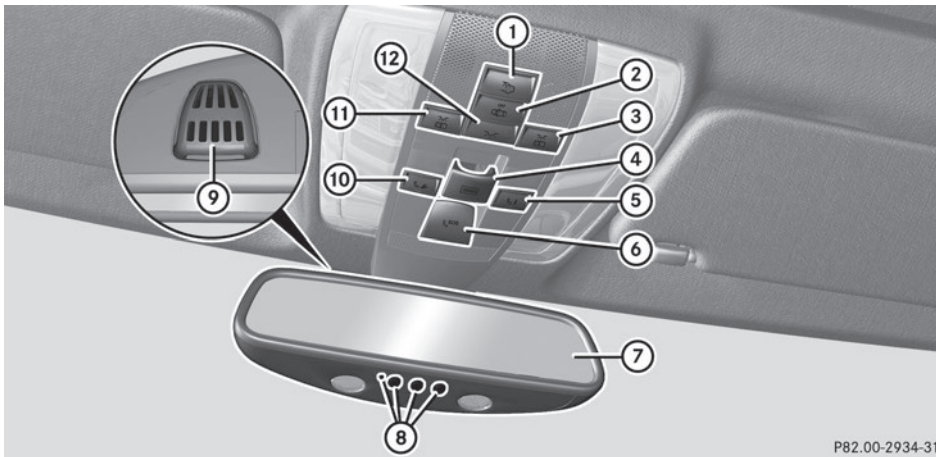

	Function	Page		Function	Page
⑨	Stowage compartment Ashtray Cigarette lighter	262 269 270	⑬	Audio/COMAND controller; see the separate operating instructions	
⑩	Selector lever	154	⑭	 Selects the drive program	156
⑪	Cup holder	267			
⑫	Stowage compartment	262			



Overhead control panel

At a glance



P82.00-2934-31

	Function	Page
①	 Switches the rear-compartment interior lighting on/off	120
②	 Switches the automatic interior lighting control on/off	120
③	 Switches the right-hand reading lamp on/off	120
④	 Opens/closes the sliding sunroof  Opens/closes the panorama roof with power tilt/sliding panel with roller sunblinds	92 93
⑤	 MB Info call button (mbrace system)	276
⑥	 SOS button (mbrace system)	274

	Function	Page
⑦	Rear-view mirror	107
⑧	Buttons for the garage door opener	283
⑨	Microphone for mbrace (emergency call system), telephone and the Voice Control System ¹	
⑩	 Roadside Assistance call button (mbrace system)	276
⑪	 Switches the left-hand reading lamp on/off	120
⑫	 Switches the front interior lighting on/off	120

¹ The Voice Control System is only available in combination with COMAND. Observe the additional operating instructions.

Door control panel

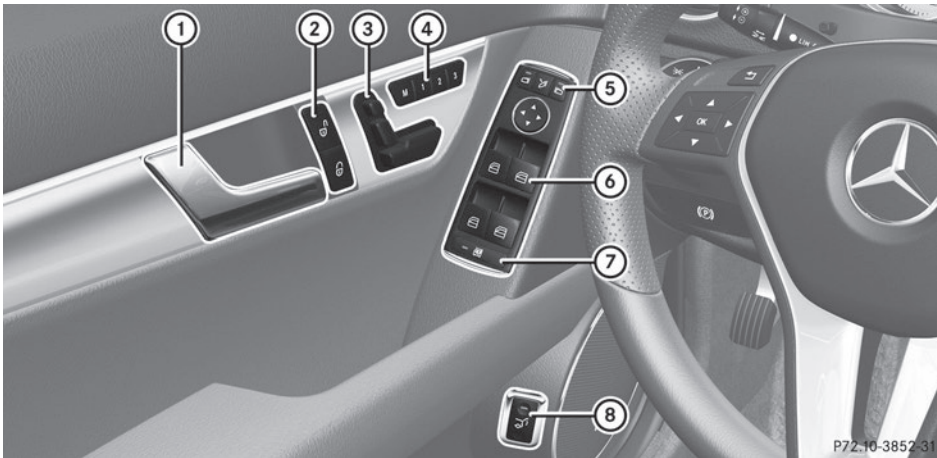

At a glance

	Function	Page
①	Opens the door	82
②	Unlocks/locks the vehicle	82
③	Adjusts the seats electrically	100
④	Stores settings for the seat, exterior mirrors and steering wheel	110
⑤	Adjusts and folds the exterior mirrors in/out electrically	107

	Function	Page
⑥	Opens/closes the side windows	88
⑦	Activates/deactivates the override feature for the side windows in the rear compartment	64
⑧	Opens the trunk lid	86

Useful information	40
Panic alarm	40
Occupant safety	40
Children in the vehicle	59
Driving safety systems	65
Theft deterrent locking system	72

Useful information

- i** This Operator's Manual describes all models and all standard and optional equipment of your vehicle available at the time of publication of the Operator's Manual. Country-specific differences are possible. Please note that your vehicle may not be equipped with all features described. This also applies to safety-related systems and functions.
- i** Read the information on qualified specialist workshops: (▷ page 25).

Panic alarm



- ▶ **To activate:** press **PANIC** button ① for approximately one second.
An alarm sounds and the exterior lighting flashes.
 - ▶ **To deactivate:** press **PANIC** button ① again.
- or
- ▶ Insert the SmartKey into the ignition lock.
- or
- ▶ Press the KEYLESS-GO Start/Stop button.
The KEYLESS-GO key must be in the vehicle.

Occupant safety

Overview of occupant safety

In this section, you will learn the most important facts about the restraint system components of the vehicle.

The restraint system consists of:

- seat belts
- child restraint systems
- LATCH-type (ISOFIX) child seat anchors

Additional protection is provided by:

- SRS (Supplemental Restraint System)
- NECK-PRO head restraints/NECK-PRO luxury head restraints
- air bag system components with:
 - PASSENGER AIR BAG OFF indicator lamp
 - front-passenger seat with Occupant Classification System (OCS)

The different air bag systems work independently of each other. The protective functions of the system work in conjunction with each other. Not all air bags are always deployed in an accident.

⚠ WARNING

Modifications to or work improperly conducted on restraint system components or their wiring, as well as tampering with interconnected electronic systems, can lead to the restraint systems no longer functioning as intended.

Air bags or Emergency Tensioning Devices (ETDs), for example, could deploy inadvertently or fail to deploy in accidents although the deceleration threshold for air bag deployment is exceeded. Therefore, never modify the restraint systems. Do not tamper with electronic components or their software.

- i** For information on infants and children traveling with you in the vehicle restraint systems for infants and children, see "Children in the vehicle" (▷ page 59).

SRS (Supplemental Restraint System)

Introduction

SRS consists of:

- The  SRS warning lamp
- Air bags
- Air bag control unit (with crash sensors)
- Emergency Tensioning Devices
- Belt force limiters

SRS reduces the risk of occupants coming into contact with the vehicle's interior in the event of an accident. It can also reduce the effect of the forces to which occupants are subjected during an accident.

SRS warning lamp

WARNING

If SRS is malfunctioning, child restraint system components may be triggered unintentionally or might not be triggered at all in the event of an accident with a high rate of vehicle deceleration. There is an increased risk of injury, possibly even fatal.



Have SRS checked and repaired immediately at a qualified specialist workshop.

SRS functions are checked regularly when you switch on the ignition and when the engine is running. Therefore, malfunctions can be detected in good time.

The  SRS warning lamp in the instrument cluster lights up when the ignition is switched on. It goes out no later than a few seconds after the engine is started.

The SRS components are in operational readiness when the  SRS warning lamp goes out while the engine is running.

There is a malfunction if:

- the  SRS warning lamp does not light up when the ignition is switched on
- the engine is running and the  SRS warning lamp does not go out after a few seconds
- the engine is running and the  SRS warning lamp lights up again

Safety guidelines for seat belts, Emergency Tensioning Devices (ETDs) and air bags

WARNING

- Damaged seat belts or seat belts that have been subjected to stress in an accident must be replaced. Their anchoring points must also be checked. Only use seat belts installed or supplied by an authorized Mercedes-Benz Center.
- Air bags and pyrotechnic Emergency Tensioning Devices (ETDs) contain perchlorate material, which may require special handling and regard for the environment. Check your national disposal guidelines. California residents, see www.dtsc.ca.gov/HazardousWaste/Perchlorate/index.cfm.
- Air bags and ETDs are designed to function on a one-time-only basis. An air bag or ETD that has deployed must be replaced.
- Do not pass seat belts over sharp edges. They could tear.
- Do not make any modification that could change the effectiveness of the seat belts.
- Do not bleach or dye seat belts as this may severely weaken them. In a crash they may not be able to provide adequate protection.
- No modifications of any kind may be made to any components or wiring of the SRS.
- Do not change or remove any component or part of the SRS.
- Do not install additional trim material, seat covers, badges, etc. over the steering wheel hub, front-passenger front air bag

cover, outer sides of the seat backrests, door trim panels, or door frame trims.

- Do not install additional electrical/ electronic equipment on or near SRS components and wiring.
- Keep area between air bags and occupants free of objects (e.g. packages, purses, umbrellas, etc.).
- Do not hang items such as coat hangers from the coat hooks or handles over the door. These items may be thrown around in the vehicle and cause head and other injuries when the window curtain air bag is deployed.
- Air bag system components will be hot after an air bag has inflated. Do not touch them.
- Never place your feet on the instrument panel, dashboard, or on the seat. Always keep both feet on the floor in front of the seat.
- Improper repair work on the SRS creates a risk of rendering the SRS inoperative or causing unintended air bag deployment. Work on the SRS must therefore only be performed by qualified technicians. Contact an authorized Mercedes-Benz Center.
- For your protection and the protection of others, when scrapping the air bag unit or ETD, our safety instructions must be followed. These instructions are available from any authorized Mercedes-Benz Center.
- Given the considerable deployment speed, required inflation volume, and the material of the air bags, there is the possibility of abrasions or other, potentially more serious injuries resulting from air bag deployment.

If you sell your vehicle, Mercedes-Benz strongly recommends that you inform the subsequent owner that the vehicle is equipped with SRS. Also, refer them to the applicable section in the Operator's Manual.

Air bags

Important safety notes

WARNING

Using unsuitable seat covers could restrict or even prevent deployment of the air bags integrated into the seats. Consequently, the air bags cannot protect vehicle occupants as they are designed to do. In addition, the function of the air bag deactivation system could be restricted. This poses an increased risk of injury or even fatal injury.

You should only use seat covers that have been approved for the respective seat by Mercedes-Benz.

WARNING

The air bag parts are hot after the airbag has been deployed. There is a risk of injury.

Do not touch the air bag parts. Have the deployed air bags replaced at a qualified specialist workshop as soon as possible.

WARNING

Air bags are designed to reduce the incidence of injuries and fatalities in certain situations:

- frontal impacts (driver's and front-passenger front air bags and driver's knee bag)
- side impacts (side impact air bags, window curtain air bags and pelvis air bags)

However, no system available today can completely eliminate injuries and fatalities.

When the air bags are deployed, a small amount of powder is released. The powder generally does not constitute a health hazard and does not indicate that there is a fire in the vehicle. In order to prevent potential breathing difficulties, you should leave the vehicle as soon as it is safe to do so. If you have any breathing difficulty but cannot get out of the vehicle after the air bag inflates, then get fresh air by opening a window or door.

 **WARNING**

In order to reduce the potential danger of injuries caused during the deployment of the front air bags, the driver and front passenger must always be correctly seated and wear their seat belts.

For maximum protection in the event of a collision, you must always be in the normal seat position with your back against the backrest. Fasten your seat belt and make sure that it is correctly positioned on your body.

As the air bag inflates with considerable speed and force, a proper seating position and correct positioning of the hands on the steering wheel will help to keep you at a safe distance from the air bag. Occupants who are not wearing their seat belt, are not seated properly or are too close to the air bag can be seriously injured or killed by an air bag, as it inflates with great force instantaneously:

- sit with the seat belt fastened correctly and in a position that is as upright as possible with your back against the backrest.
- move the driver's seat as far back as possible, still permitting proper operation of vehicle controls. The distance from the center of the driver's chest to the center of the air bag cover on the steering wheel must be at least 10 inches (25 cm). You should be able to accomplish this by adjusting the seat and steering wheel. If you have any difficulties, please contact an authorized Mercedes-Benz Center.
- do not lean your head or chest close to the steering wheel or dashboard.
- only hold the steering wheel on the outside. Placing hands and arms inside the rim can increase the risk and potential severity of hand/arm injury if the driver front air bag inflates.
- adjust the front-passenger seat as far back as possible from the dashboard when the seat is occupied.
- occupants, especially children, should never place their bodies or lean their heads in the area of the door where the side

impact air bag inflates. This could result in serious or fatal injuries should the side impact air bag be deployed. Always sit as upright as possible, wear the seat belt properly and use an appropriately sized infant restraint, toddler restraint or booster seat recommended for the size and weight of the child.

Failure to follow these instructions can result in severe injuries to you or other occupants.

If you sell your vehicle, it is important that you make the buyer aware of this safety information. Be sure to give the buyer this Operator's Manual.

The air bag installation locations are identified by the AIR BAG symbol.

The air bags are deployed if the air bag control unit detects the need for deployment. Only in the event of such a situation will the air bags provide their supplemental protection.

If the driver and front passenger do not wear their seat belts, it is not possible for the air bags to provide their supplemental protection.

In the event of other types of impacts and impacts below air bag deployment thresholds, the air bags will not deploy. The driver and passenger will then be protected to the extent possible by a properly fastened seat belt. A properly fastened seat belt is also needed to provide the best possible protection in a rollover.

Air bags provide additional protection; they are not, however, a substitute for seat belts. All vehicle occupants must fasten their seat belts regardless of whether your vehicle is equipped with air bags or not.

It is important for your safety and that of your passenger to have deployed air bags replaced and to have any malfunctioning air bags repaired. This will help to make sure the air bags continue to perform their protective function for the vehicle occupants in the event of a crash.

- i** After an air bag has been deployed, have the vehicle towed to the nearest qualified specialist workshop, even if your vehicle is ready to drive.

Front air bags

The front air bags increase protection for the driver's and front passenger's head and chest.

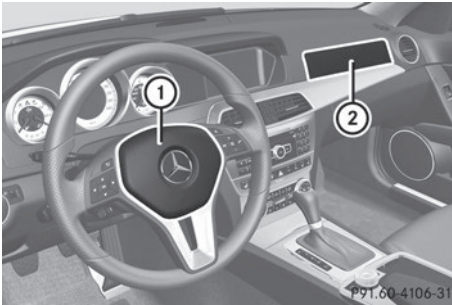

Driver's air bag ① deploys in front of the steering wheel; front-passenger front air bag ② deploys in front of and above the glove box.

They are deployed:

- at the start of an accident with a high rate of vehicle acceleration or deceleration in a longitudinal direction
- if the system determines that air bag deployment can offer additional protection to that provided by the seat belt
- independently of other air bags in the vehicle

The release time of the front air bags is dependent upon the use of the seat belt.

Your vehicle has adaptive, two-stage front air bags. In the event of a collision, the air bag control unit evaluates the vehicle deceleration. In the first deployment stage, the front air bag is filled with enough propellant gas to reduce the risk of injuries. The front air bag is fully deployed if a second deployment threshold is exceeded within a few milliseconds.

The deployment of front-passenger front air bag ② is also influenced by the weight category of the front passenger, which is determined by the Occupant Classification System (OCS) (▷ page 47).

The lighter the passenger-side occupant, the higher the vehicle deceleration rate required (predicted at the start of the impact) for second stage inflation of the front-passenger front air bag. In the second stage, the front air bags are inflated with the maximum amount of propellant gas available.

The front air bags are not deployed in situations where a low impact severity is predicted. You will then be protected by the fastened seat belt.

The front-passenger front air bag will only be deployed if:

- the system, based on the OCS weight sensor readings, detects that the front-passenger seat is occupied
- the PASSENGER AIR BAG OFF indicator lamp on the center console is not lit (▷ page 47)
- the air bag control unit predicts a high-impact severity

Driver's knee bag



Driver's knee bag ① increases the driver's protection against:

- knee injuries
- thigh injuries
- lower leg injuries

Driver's knee bag ① deploys under the steering column. If, during a frontal collision, the system determines that air bag deployment can offer additional protection to that provided by the seat belt, driver's knee bag ① is deployed along with the driver's air bag. Driver's knee bag ① operates best in conjunction with correctly positioned and fastened seat belts.

Side impact air bags

WARNING

Using unsuitable seat covers could restrict or even prevent deployment of the air bags integrated into the seats. Consequently, the air bags cannot protect vehicle occupants as they are designed to do. In addition, the function of the air bag deactivation system could be restricted. This poses an increased risk of injury or even fatal injury.

You should only use seat covers that have been approved for the respective seat by Mercedes-Benz.

WARNING

Sensors to control the air bags are located in the doors. Modifications or work not performed correctly to the doors or door paneling, as well as damaged doors, can lead to the function of the sensors being impaired. The air bags might therefore not function properly any more. Consequently, the air bags cannot protect vehicle occupants as they are designed to do. There is an increased risk of injury.

Never modify the doors or parts of the doors. Always have work on the doors or door paneling carried out at a qualified specialist workshop.

You should only use seat covers that have been approved for your vehicle by Mercedes-Benz. The seat covers must have a special tear seam for side impact air bags. Otherwise, the side impact air bags cannot deploy correctly and therefore cannot provide the

intended protection in the event of an accident.

When deployed, the side impact air bags offer additional protection for the thorax of the vehicle occupants on the side of the vehicle on which the impact occurs. However, they do not protect the:

- head
- neck
- arms

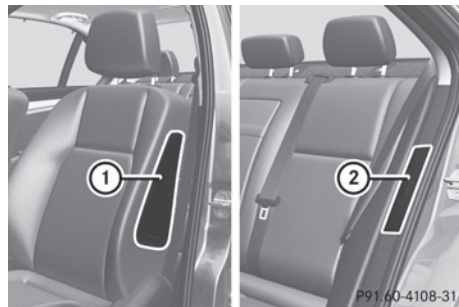

Front side impact air bags ① and rear side impact air bags ② deploy next to the outer seat cushions.

The side impact air bags are deployed:

- on the side on which an impact occurs
- at the start of an accident with a high rate of lateral vehicle deceleration or acceleration, e.g. in a side impact
- independently of the use of the seat belt
- independently of the front air bags
- independently of the ETDs

Side impact air bags will not deploy in side impacts which do not exceed the system's preset deployment thresholds for lateral acceleration/deceleration. You will then be protected by the fastened seat belt.

The side impact air bag on the front-passenger side is not deployed in the following situations:

- OCS has detected that the front-passenger seat is unoccupied.
- the front-passenger seat belt is not fastened.

The side impact air bag on the front-passenger side will deploy if the front-passenger seat belt is fastened, regardless of whether the front-passenger seat is occupied or not.

Pelvis air bags

Pelvis air bags are not available for AMG vehicles.

WARNING

Only use seat covers which have been tested and approved by Mercedes-Benz for your vehicle model. Using seat covers or other seat coverings can cause a malfunction of the side impact air bags and/or the pelvis air bags. Contact an authorized Mercedes-Benz Center for availability.

Pelvis air bag deployment enhances the level of protection of the vehicle occupants on the side of the vehicle on which the impact occurs.



Pelvis air bags ① deploy next to and below the outer seat cushions. They are deployed:

- on the side on which an impact occurs
- at the start of an accident with a high rate of lateral vehicle deceleration or acceleration, e.g. in a side impact
- independently of the use of the seat belt
- independently of the front air bags
- independently of the ETDs

Pelvis air bags ① will not deploy in side impacts which do not exceed the system's preset deployment thresholds for lateral

acceleration/deceleration. You will then be protected by the fastened seat belt.

The pelvis air bag on the front-passenger side is not deployed in the following situations:

- OCS has detected that the front-passenger seat is unoccupied.
- the front-passenger seat belt is not fastened.

The pelvis air bag on the front-passenger side will deploy if the front-passenger seat belt is fastened, regardless of whether the front-passenger seat is occupied or not.

Window curtain air bags

The window curtain air bags enhance the level of protection for the head, but not chest or arms, of the vehicle occupants on the side of the vehicle on which the impact occurs.

The window curtain air bags are integrated into the side of the roof frame and deploy in the area from the A-pillar to the C-pillar.

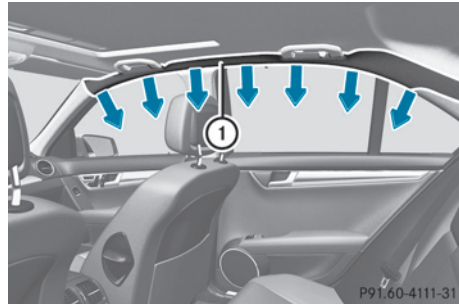

Window curtain air bags ① are deployed:

- on the side on which an impact occurs
- at the start of an accident with a high rate of lateral vehicle deceleration or acceleration, e.g. in a side impact
- regardless of whether the front-passenger seat is occupied
- independently of the use of the seat belt
- independently of the front air bags

Window curtain air bags ① will not deploy in the event of impacts which do not exceed the system's preset deployment thresholds for

vehicle acceleration/deceleration. You will then be protected by the fastened seat belt.

Occupant Classification System (OCS)

How the Occupant Classification System works

The Occupant Classification System (OCS) categorizes the occupant on the front-passenger seat using a weight sensor. The front-passenger front air bag is deactivated automatically for certain weight categories. The PASSENGER AIR BAG OFF indicator lamp shows you the current status. If the PASSENGER AIR BAG OFF indicator lamp is lit, the passenger air bag is disabled.

The system does not deactivate:

- the side impact air bag
- the pelvis air bag
- the window curtain air bag
- the Emergency Tensioning Devices

To be classified correctly, the front passenger must sit:

- with the seat belt fastened correctly
- in a position that is as upright as possible with their back against the seat backrest
- with their feet on the floor

The OCS weight sensor reading is affected if the occupant's weight is transferred, e.g. by leaning on the armrest.



If the front-passenger seat, the seat cover or the seat cushion are damaged, have the necessary repair work carried out at a qualified specialist workshop.

For safety reasons, Mercedes-Benz recommends that you only use seat accessories that have been approved by Mercedes-Benz.

Both the driver and the front passenger should always observe the PASSENGER AIR BAG OFF indicator lamp as an indication of whether or not the front passenger is positioned correctly. Observe also the air bag

display messages that can be displayed in the instrument cluster (▷ page 229).



WARNING

If the  indicator lamp illuminates when an adult or someone larger than a small individual is in the front passenger seat, have the front passenger reposition himself or herself in the seat until the  indicator lamp goes out.

In the event of a collision, the air bag control unit will not allow front passenger front air bag deployment when the OCS has classified the front passenger seat occupant as weighing as much as or less than a typical 12-month-old child in a standard child restraint or if the front passenger seat is classified as being empty.

When the OCS senses that the front passenger seat occupant is classified as being up to or less than the weight of a typical 12-month-old child in a standard child restraint, the  indicator lamp will illuminate when the engine is started and remain illuminated. This indicates that the front passenger front air bag is deactivated.

When the OCS senses that the front passenger seat is classified as being empty, the  indicator lamp will illuminate when the engine is started and remain illuminated. This indicates that the front passenger front air bag is deactivated.

When the OCS senses that the front passenger seat occupant is classified as being heavier than the weight of a typical 12-month-old child seated in a standard child restraint or as being a small individual (such as a young teenager or a small adult), the  indicator lamp will illuminate for approximately 6 seconds when the engine is started. Depending on occupant weight sensor readings from the seat, it will then remain illuminated or go out. With the  indicator lamp illuminated, the front passenger front air bag is deactivated.

With the  indicator lamp out, the front passenger front air bag is activated.

When the OCS senses that the front passenger seat occupant is classified as an adult or someone larger than a small individual, the  indicator lamp will illuminate for approximately six seconds when the engine is started and then go out. This indicates that the front passenger front air bag is activated.

If the  indicator lamp is illuminated, the front passenger front air bag is deactivated and will not be deployed.

If the  indicator lamp is not illuminated, the front passenger front air bag is activated and will be deployed

- in the event of certain frontal impacts
- if the impact exceeds a predetermined triggering threshold
- independent of the side impact air bag or pelvis air bag

If the front passenger front air bag is deployed, the rate of inflation will be influenced by

- the rate of vehicle deceleration as assessed by the air bag control unit
- the front passenger's weight category as identified by the OCS





WARNING

According to accident statistics, children are safer when properly restrained on the rear seats than on the front-passenger seat. Thus, we strongly recommend that children be placed in the rear seats whenever possible. Regardless of seating position, children 12 years old and under must be seated and properly secured in an appropriate infant restraint, toddler restraint, or booster seat recommended for the size and weight of the child.

The infant or child restraint must be properly secured with the vehicle's seat belt, the seat belt and Top Tether strap, or lower anchors and Top Tether strap, fully in accordance with the child seat manufacturer's instructions.

Occupants, especially children, should always sit as upright as possible, wear the seat belt properly and use an appropriately sized infant restraint, toddler restraint, or booster seat recommended for the size and weight of the child.

Children can be killed or seriously injured by an inflating air bag. Note the following important information when circumstances require you to place a child in the front-passenger seat:

- Your vehicle is equipped with air bag technology designed to deactivate the front-passenger front air bag in your vehicle when the system senses the weight of a typical 12-month-old child or less along with the weight of a standard appropriate child restraint on the front-passenger seat.
- A child in a rear-facing child restraint on the front-passenger seat will be seriously injured or even killed if the front-passenger front air bag inflates in a collision which could occur under some circumstances, even with the air bag technology installed in your vehicle. The only means to eliminate this risk completely is never to place a child in a rear-facing child restraint in the front-passenger seat. We therefore strongly recommend that you always place a child in a rear-facing child restraint on the rear seat.
- If you install a rear-facing child restraint on the front-passenger seat, make sure the  indicator lamp is illuminated, indicating that the front-passenger front air bag is deactivated. Should the  indicator lamp not illuminate or go out while the restraint is installed, please check installation. Periodically check the  indicator lamp while driving to make sure that the  indicator lamp is illuminated. If the  indicator lamp goes out or remains out, do not transport a child on the front-passenger seat until the system has been repaired.

A child in a rear-facing child restraint on the front-passenger seat will be seriously injured or even killed if the front-passenger front air bag inflates.

- If you place a child in a forward-facing child restraint on the front-passenger seat:
 - move the seat as far back as possible
 - use the proper child restraint recommended for the age, size and weight of the child
 - secure child restraint with the vehicle's seat belt according to the child seat manufacturer's instructions
- For children larger than the typical 12-month-old child, the front-passenger front air bag may or may not be activated.

If the driver's air bag deploys, this does not mean that the front-passenger front air bag will also deploy.

The OCS may have detected that the seat:



- is empty or occupied by the weight of a typical child up to twelve months old, seated in a child restraint system.
- is occupied by a small individual, such as a young teenager or a small adult.
- is occupied by a child in a child restraint system whose weight is greater than that of a typical twelve month old child.

These are examples of when the OCS deactivates the front-passenger front air bag. Deactivation takes place although the collision fulfills the criteria for deploying the driver's air bag.



If the SmartKey is removed from the ignition lock or is in position **0**, the PASSENGER AIR BAG OFF indicator lamp does not light up.

WARNING

If the red  SRS warning lamp in the instrument cluster and the  PASS AIR BAG OFF indicator lamp light up simultaneously, the OCS is malfunctioning. The front passenger front air bag will be deactivated in this case. Have the system checked by qualified technicians as soon as possible. Contact an authorized Mercedes-Benz Center.

Only have the seat repaired or replaced at an authorized Mercedes-Benz Center.

In order to ensure proper operation of the air bag system and OCS:

- Sit with the seat belt properly fastened in a position that is as upright as possible with your back against the seat backrest.
- When seated, a passenger should not position him/herself in such a way as to cause the passenger's weight to be lifted from the seat cushion as this may result in the OCS being unable to correctly approximate the passenger's weight category.
- Read and observe all warnings in this chapter.

System self-test

The PASSENGER AIR BAG OFF indicator lamp lights up if you:

- turn the SmartKey to position **1** or **2** in the ignition lock
- press the KEYLESS-GO Start/Stop button once or twice on vehicles with KEYLESS-GO.

When an adult is sitting correctly on the front-passenger seat and is categorized by the OCS system as an adult, the PASSENGER AIR BAG OFF indicator lamp lights up and goes off again after approximately six seconds.

If the seat is not occupied and the OCS system classifies the front-passenger seat as

being empty, the PASSENGER AIR BAG OFF indicator lamp will continue to light up and not go out.

 **WARNING**

If the  indicator lamp does not illuminate, the system is not functioning. You must contact an authorized Mercedes-Benz Center before seating any child on the front passenger seat.

For more information about the OCS, see "Problems with the Occupant Classification System" (▷ page 51).

 **WARNING**

Objects between the seat surface and the child restraint system could affect the function of the OCS. This could result in the front-passenger front air bag not functioning as intended during an accident. This poses an increased risk of injury or even fatal injury.

Do not place any objects between the seat surface and the child restraint system. Make sure that the bottom and back of the child restraint system make full contact with the front-passenger seat cushion and backrest. Always comply with the child restraint system manufacturer's installation instructions.

Problems with the Occupant Classification System

Problem	Possible causes/consequences and ► Solutions
<p>The PASSENGER AIR BAG OFF indicator lights up and remains on.</p> <p>The person on the front-passenger seat:</p> <ul style="list-style-type: none"> • has the weight of a typical adult • has been determined by the system not to be a child 	<p>The OCS is malfunctioning.</p> <ul style="list-style-type: none"> ► Make sure that the front passenger is sitting in a correct, upright position. ► Have the OCS checked as soon as possible at a qualified specialist workshop. ► Observe the additional display messages in the multifunction display (▷ page 229).

WARNING

If the  indicator lamp illuminates and remains illuminated when the weight of a typical adult or someone larger than a small individual has been detected on the passenger seat, do not allow any occupant to use the passenger seat until the system has been repaired.

Problem	Possible causes/consequences and ► Solutions
<p>The PASSENGER AIR BAG OFF indicator lamp does not light up and/or stays on.</p> <p>The front-passenger seat is:</p> <ul style="list-style-type: none"> • unoccupied • occupied with a weight up to that of a typical twelve-month-old child in a standard child restraint system 	<p>The OCS is malfunctioning.</p> <ul style="list-style-type: none"> ► Make sure there is nothing between the seat cushion and the child seat. ► Make sure that the backrest and base of the child restraint system are resting securely on the front-passenger seat. If necessary, adjust the position of the front-passenger seat. ► When installing the child restraint system, make sure that the seat belt is tight. Do not pull the seat belt tight with the front-passenger seat adjustment. This could result in the seat belt being pulled too tightly. ► Check the installation of the child restraint system. ► Make sure that no objects are applying additional weight onto the seat. ► If the PASSENGER AIR BAG OFF indicator lamp remains off, have the OCS system checked as soon as possible at a qualified specialist workshop. Do not transport a child on the front-passenger seat until the OCS has been repaired. ► Observe the additional display messages in the multifunction display (▷ page 229).

⚠ WARNING

If the  indicator lamp does not illuminate or remains out with the weight of a typical 12-month-old child in a standard child restraint or less, or is unoccupied, on the front-passenger seat, do not transport a child on the front-passenger seat until the system has been repaired.

PRE-SAFE® (anticipatory occupant protection system)**⚠ WARNING**

The PRE-SAFE® system reduces the impact of an accident on vehicle occupants, as long as their seat belts have been fastened correctly. Although your vehicle is equipped with a PRE-SAFE® system, the possibility of injury in the event of an accident cannot be ruled out. You should therefore always drive carefully and adapt your driving style to the prevailing road, weather and traffic conditions.

PRE-SAFE® takes preemptive measures to protect occupants in certain hazardous situations.

PRE-SAFE® intervenes:

- if BAS PLUS intervenes powerfully on vehicles with DISTRONIC PLUS
- if, on vehicles with DISTRONIC PLUS, the radar sensor system detects an imminent danger of collision in certain situations
- in critical driving situations, e.g. when physical limits are exceeded and the vehicle understeers or oversteers severely

PRE-SAFE® takes the following measures depending on the hazardous situation detected:

- the front seat belts are pre-tensioned.
- on vehicles with memory function for the front-passenger seat: the front-passenger seat is adjusted if it is in an unfavorable position.
- if the vehicle skids, the sliding sunroof, panorama roof with power tilt/sliding panel and the side windows are closed so that only a small gap remains.

If the hazardous situation passes without resulting in an accident, PRE-SAFE® slackens the belt pre-tensioning. All settings made by PRE-SAFE® can then be reversed.

If the seat belts are not released:

- ▶ When the vehicle is stationary, move the backrest or seat back slightly. The seat belt pre-tensioning is reduced and the locking mechanism is released.

⚠ WARNING

Make sure that nobody can become trapped as you adjust the seat.

- ❗ Make sure that there are no objects in the footwell or behind the seats when resetting the seats. There is a risk that the seats and/or the objects could be damaged.

More information about seat belt adjustment, a convenience function integrated into PRE-SAFE®, can be found in the "Seat belt adjustment" section (> page 56).

NECK-PRO head restraints/NECK-PRO luxury head restraints (except AMG vehicles)**⚠ WARNING**

The function of the head restraint may be impaired if you:

- attach objects such as coat hangers to the head restraints, for example
- use head restraint covers

If you do so, the head restraints cannot fulfill their intended protective function in the event of an accident. In addition, objects attached to the head restraints could endanger other

vehicle occupants. There is an increased risk of injury.

Do not attach any objects to the head restraints and do not use head restraint covers.

NECK-PRO head restraints/NECK-PRO luxury head restraints increase protection of the driver's and front-passenger's head and neck. In the event of a rear collision of a certain severity, the NECK-PRO head restraints/NECK-PRO luxury head restraints on the driver's and the front-passenger seats are moved forwards and upwards. This provides better head support.

If the NECK-PRO head restraints/NECK-PRO luxury head restraints have been triggered in an accident, reset the NECK-PRO head restraints/NECK-PRO luxury head restraints on the driver's and front-passenger seats (▷ page 53). Otherwise, the additional protection will not be available in the event of another rear-end collision. NECK-PRO head restraints/NECK-PRO luxury head restraints that have been triggered are moved forwards and can no longer be adjusted.

Mercedes-Benz recommends that you have the NECK-PRO head restraints/NECK-PRO luxury head restraints checked at a qualified specialist workshop after a rear-end collision.

Resetting triggered NECK-PRO head restraints/NECK-PRO luxury head restraints

Important safety notes

WARNING

For reasons of safety, have the NECK-PRO head restraints/NECK-PRO luxury head restraints checked at an authorized Mercedes-Benz Center after a rear-end collision.

WARNING

When pushing back the NECK-PRO head restraint cushion, make sure your fingers do not become caught between the head restraint cushion and the cover. Failure to observe this could result in injuries.

NECK-PRO head restraints

-  Resetting the NECK-PRO head restraints requires a lot of strength. If you have difficulty resetting the NECK-PRO head restraints, have this work carried out at a qualified specialist workshop, e.g. an authorized Mercedes-Benz Center.

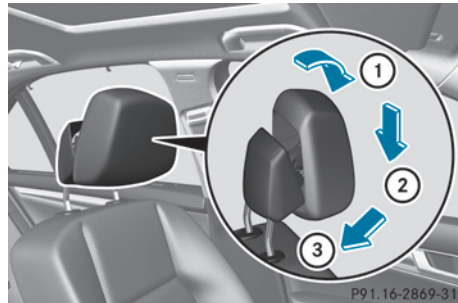

- ▶ Tilt the top of the NECK-PRO head restraint cushion forwards in the direction of arrow ①.
- ▶ Push the NECK-PRO head restraint cushion down in the direction of arrow ② as far as it will go.
- ▶ Firmly push the NECK-PRO head restraint cushion back in the direction of arrow ③ until the cushion engages.
- ▶ Repeat this procedure for the second NECK-PRO head restraint.

NECK-PRO luxury head restraints

-  If you have difficulty resetting the NECK-PRO luxury head restraints, have this work carried out at a qualified specialist workshop, e.g. an authorized Mercedes-Benz Center.

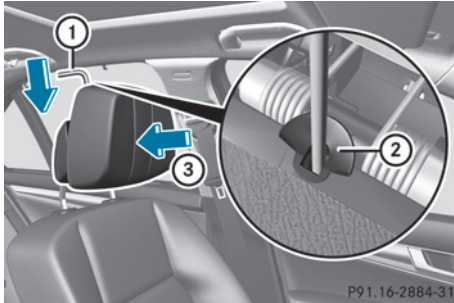

- ▶ Remove resetting tool ① from the vehicle document wallet.
- ▶ Slide resetting tool ① into guide ② between the NECK-PRO luxury head restraint and the rear cover of the head restraint.
- ▶ Push resetting tool ① downwards until you hear the head restraint deployment mechanism engage.
- ▶ Pull out resetting tool ①.
- ▶ Firmly press the NECK-PRO luxury head restraint cushion back ③ until it engages.
- ▶ Repeat this procedure for the second NECK-PRO luxury head restraint.
- ▶ Put resetting tool ① back into the vehicle document wallet.

Seat belts

Important safety notes

The use of seat belts and infant and child restraint systems is required by law in:

- all 50 states
- the U.S. territories
- the District of Columbia
- all Canadian provinces

Even where this is not the case, all vehicle occupants should have their seat belts fastened when the vehicle is in motion.

- ❗ See "Children in the vehicle" (▷ page 59) for further information on

infants and children traveling in the vehicle as well as on child restraint systems.

⚠ WARNING

The seat belt does not offer the intended level of protection if the backrest is not in the upright position. When braking or in the event of an accident, you could slide underneath the seat belt and sustain abdomen or neck injuries, for example. This poses an increased risk of injury or even fatal injury.

Adjust the seat properly before beginning your journey. Always make sure that the seat is in the upright position.

⚠ WARNING

Seat belts cannot protect as intended, if:

- they are damaged, extremely dirty, bleached or dyed
- the seat belt buckle is damaged or extremely dirty
- the Emergency Tensioning Devices or the belt anchorage has been modified.

Damage caused to seat belts in an accident may not be visible, e.g. by splinters of glass. Modified or damaged seat belts can tear or fail, for example in the event of an accident. Modified Emergency Tensioning Devices may be deployed unintentionally or fail to be deployed when required. There is an increased risk of injury, possibly even fatal.

Never modify seat belts, Emergency Tensioning Devices, seat belt anchorages and inertia reels. Ensure that seat belts are not damaged or worn and are clean.

Only use seat belts that have been approved for your vehicle by Mercedes-Benz.

The use of seat belts and infant and child restraint systems is required by law in:

- all 50 states
- the U.S. territories
- the District of Columbia
- all Canadian provinces

Even where this is not required by law, all vehicle occupants should correctly fasten their seat belts before starting the journey.

- **i** See "Children in the vehicle" (> page 59) for further information on infants and children traveling in the vehicle as well as on child restraint systems.

Correct use of the seat belts

WARNING

USE SEAT BELTS PROPERLY

- Seat belts can only work when used properly. Never wear seat belts in any other way than as described in this section, as that could result in serious injuries in the event of an accident.
 - Each occupant should wear their seat belt at all times, because seat belts help reduce the likelihood of and potential severity of injuries in accidents, including rollovers. The integrated restraint system includes SRS (driver front air bag, driver's side knee bag, front-passenger front air bag, side impact air bags, pelvis air bags, window curtain air bags for the side windows), Emergency Tensioning Devices, seat belt force limiters, and front seat knee bolsters. The system is designed to enhance the protection offered to properly belted occupants in certain frontal (front air bags, driver's side knee bag, and ETDs) and side (side impact air bags, pelvis air bags, window curtain air bags, and ETDs) impacts which exceed preset deployment thresholds.
 - Never wear the shoulder belt under your arm, across your neck or off your shoulder. In a frontal crash, your body would move too far forward. That would increase the chance of head and neck injuries. The seat belt would also apply too much force to the ribs or abdomen, which could severely injure internal organs such as your liver or spleen.
- Adjust the seat belt so that the shoulder section is located as close as possible to the middle of the shoulder. It should not touch the neck. Never pass the shoulder portion of the seat belt under your arm.
- Position the lap belt as low as possible on your hips and not across the abdomen. If the lap belt is positioned across your abdomen, it could cause serious injuries in a crash.
 - Never wear seat belts over rigid or breakable objects in or on your clothing, such as eyeglasses, pens, keys etc., as these might cause injuries.
 - Make sure the seat belt is always fitted snugly. Take special care of this when wearing loose clothing.
 - Never use a seat belt for more than one person at a time. Do not fasten a seat belt around a person and another person or other objects at the same time.
 - Seat belts should not be worn twisted. In a crash, you would not have the full width of the seat belt to distribute impact forces. The twisted seat belt against your body could cause injuries.
 - Pregnant women should also always use a lap-shoulder belt. The lap belt portion should be positioned as low as possible on the hips to avoid any possible pressure on the abdomen.
 - Place the seat backrest in a position that is as upright as possible.
 - Check your seat belt during travel to make sure it is properly positioned.
 - Never place your feet on the instrument panel, dashboard, or on the seat. Always keep both feet on the floor in front of the seat.
 - When using a seat belt to secure infant restraints, toddler restraints, or children in booster seats, always follow the child seat manufacturer's instructions.

⚠ WARNING

Do not pass seat belts over sharp edges. They could tear.

Do not allow the seat belt to get caught in the door or in the seat adjustment mechanism. This could damage the seat belt.

Never attempt to make modifications to seat belts. This could impair the effectiveness of the seat belts.

Fastening seat belts**⚠ WARNING**

According to accident statistics, children are safer when properly restrained on the rear seats than on the front-passenger seat. Thus, we strongly recommend that children be placed in the rear seat whenever possible. Regardless of seating position, children 12 years old and under must be seated and properly secured in an appropriately sized child restraint system or booster seat recommended for the size and weight of the child. For additional information, see the "Children in the vehicle" section.

A child's risk of serious or fatal injuries is significantly increased if the child restraints are not properly secured in the vehicle and/or the child is not properly secured in the child restraint.



P91.40-3188-31

- ▶ Adjust the seat and move the backrest to an almost vertical position (▷ page 98).
- ▶ Pull the seat belt smoothly through belt sash guide ①.
- ▶ Without twisting it, guide the shoulder section of the seat belt across the middle of your shoulder and the lap section across your pelvis.
- ▶ Engage belt tongue ② in buckle ③.
- ▶ If necessary, adjust the seat belt to the appropriate height (▷ page 56).
- ▶ If necessary, pull upwards on the shoulder section of the seat belt to tighten the belt across your body.

All seat belts except the driver's seat belt are equipped with a special seat belt retractor to securely fasten child restraint systems in the vehicle. For further information on special seat belt retractors, see (▷ page 61).

For more information about releasing the seat belt with release button ④, see "Releasing seat belts" (▷ page 57).

Seat belt adjustment

The seat-belt adjustment function adjusts the driver's and front-passenger seat belt to the upper body of the occupants.

The belt strap is tightened slightly when:

- you engage the belt tongue in the belt buckle and you then turn the SmartKey to position **2** in the ignition lock.

The seat-belt adjustment is an integral part of the PRE-SAFE® convenience function. More information about PRE-SAFE® can be found in the "PRE-SAFE® (anticipatory occupant protection system)" section (▷ page 52).

Belt height adjustment

You can adjust the seat belt height on the driver's seat and the front-passenger seat.

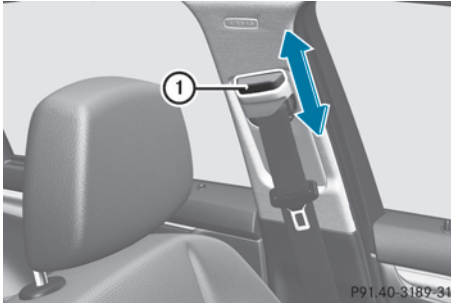

Adjust the height so that the upper part of the seat belt is routed across the center of your shoulder.

- ▶ **To raise:** slide the belt sash guide upwards. The belt sash guide engages in various positions.
- ▶ **To lower:** press and hold belt sash guide release ①.
- ▶ Slide the belt sash guide downwards.
- ▶ Release belt sash guide release ① and make sure that the belt sash guide has engaged.

Releasing seat belts



- ▶ Press release button ④ on belt buckle ③.
- ▶ Guide belt tongue ② to belt sash guide ①.

- ❗ Make sure that the seat belt is fully rolled up. Otherwise, the seat belt or belt tongue will be trapped in the door or in the seat mechanism. This could damage the door, the door trim panel and the seat belt. Damaged seat belts can no longer fulfill their protective function and must be replaced. Visit a qualified specialist workshop.

Belt warning for the driver and front passenger

Regardless of whether the driver's and front-passenger seat belts have already been fastened, the  seat belt warning lamp lights up for six seconds each time the engine is started. It then goes out if the driver and the front passenger have already fastened their seat belts.

If the driver's seat belt is not fastened when the engine is started, an additional warning tone will sound. This warning tone stops after a maximum of six seconds or once the driver's seat belt is fastened.

If after six seconds the driver or front passenger have not fastened their seat belts and the doors are closed, the  seat belt warning lamp lights up:

- until the driver's or front passenger's seat belt is fastened
- if a vehicle speed of 15 mph (25 km/h) is exceeded, a warning tone also sounds with increasing intensity for a maximum of 60 seconds or until the driver or front-passenger seat belt has been fastened.

If the driver/front passenger unfasten their seat belt while the vehicle is in motion, the  seat belt warning lamp lights up and a warning tone sounds again.

The warning tone ceases even if the driver or front-passenger seat belt has still not been fastened after 60 seconds. The  seat belt warning lamp stops flashing but remains illuminated.

After the vehicle comes to a standstill, the warning tone is reactivated and the  seat belt warning lamp flashes again if the vehicle speed again exceeds 15 mph (25 km/h).

The  seat belt warning lamp only goes out if:

- both the driver and the front passenger have fastened their seat belts.
- or
- the vehicle is stationary and a door is open.

i For more information on the  seat belt warning lamp, see "Warning and indicator lamps in the instrument cluster, seat belts" (▷ page 248).

Emergency Tensioning Devices, seat belt force limiters

WARNING

Pyrotechnic Emergency Tensioning Devices that have been deployed are no longer operational and are unable to perform their intended protective function. This poses an increased risk of injury or even fatal injury.

Therefore, have pyrotechnic Emergency Tensioning Devices which have been triggered immediately replaced at a qualified specialist workshop.

! If the front-passenger seat is not occupied, do not engage the seat belt tongue in the buckle on the front-passenger seat. Otherwise, the Emergency Tensioning Device could be triggered in the event of an accident.

i Vehicles with PRE-SAFE®: Emergency Tensioning Devices that are triggered by an electric motor can be deployed as often as desired and do not need to be replaced.

The seat belts for the front seats and rear outer seats are equipped with ETDs and seat belt force limiters.

The ETDs tighten the seat belts in an accident, pulling them close against the body.

The ETDs do not correct incorrect seat positions or incorrectly fastened seat belts. The ETDs do not pull vehicle occupants back towards the backrest.

The ETDs can only be activated when:

- the ignition is switched on
- the restraint systems are operational; see "SRS warning lamp" (▷ page 41)
- the belt tongue is engaged in the buckle on each of the lap-shoulder belts in the front
- the front-passenger seat is occupied and the belt tongue is engaged in the buckle on the front-passenger side

The ETDs on the outside seats in the rear compartment are triggered independently of the lock status of the seat belts.

The Emergency Tensioning Devices are triggered depending on the type and severity of an accident, if:

- in the event of a head-on or rear-end collision, the vehicle decelerates or accelerates rapidly in a longitudinal direction during the initial stages of the impact
- in the event of a side impact, the vehicle decelerates or accelerates rapidly in a lateral direction on the side opposite the impact

If the ETDs are deployed, you will hear a bang, and a small amount of powder may also be released. Only in rare cases will the bang affect your hearing. The powder that is released generally does not constitute a health hazard and does not indicate that there is a fire in the vehicle. The dust might cause some temporary breathing difficulty for people with asthma or other breathing trouble. To avoid this, you may wish to get out of the vehicle as soon as it is safe to do so. You can also open the window to allow fresh air to enter the vehicle interior. The  SRS warning lamp lights up.

If the seat belt is also equipped with a seat belt force limiter and this is triggered, the

force exerted by the seat belt on the vehicle occupant is reduced.

The seat belt force limiters for the front seats are synchronized with the front air bags, which take on a part of the deceleration force. This results in the force exerted on the occupant being distributed over a greater area.

Children in the vehicle

Child restraint systems

Important safety notes

Mercedes-Benz recommends that you always properly secure all infants and children with a child or infant seat restraint system for the trip.

The use of seat belts and infant and child restraint systems is required by law in:

- all 50 states
- the U.S. territories
- the District of Columbia
- all Canadian provinces

Infants and children must always be seated in an appropriate infant or child restraint system recommended for the size and weight of the child. The infant or child restraint system must be properly secured in accordance with the manufacturer's instructions.

All infant or child restraint systems must meet the following standards:

- U.S. Federal Motor Vehicle Safety Standards 213 and 225
- Canadian Motor Vehicle Safety Standards 213 and 210.2

Confirmation that the child restraint system corresponds to the standards can be found on an instruction label on the child restraint system. This confirmation can also be found in the installation instructions that are included with the child restraint system.

Always read and follow the manufacturer's instructions when using an infant or child restraint system or booster seat.

Observe all warning signs in the vehicle interior and on the infant or child restraint.



WARNING

According to accident statistics, children are safer when properly restrained in the rear seating positions than in the front seating position. Thus, we strongly recommend that children be placed in the rear seats whenever possible. Regardless of seating position, children 12 years old and under must be seated and properly secured in an appropriate infant restraint, toddler restraint, or booster seat recommended for the size and weight of the child.











The infant or child restraint must be properly secured with the vehicle's seat belt, the seat belt and top tether strap, or lower anchors and top tether strap, fully in accordance with the child seat manufacturer's instructions.

Occupants, especially children, should always sit as upright as possible, wear the seat belt properly and use an appropriately sized infant restraint, toddler restraint, or booster seat recommended for the size and weight of the child.

Children can be killed or seriously injured by an inflating air bag. Note the following important information when circumstances require you to place a child in the front passenger seat:

- Your vehicle is equipped with air bag technology designed to deactivate the front passenger front air bag in your vehicle when the system senses the weight of a typical 12-month-old child or less along with the weight of a standard appropriate child restraint on the front passenger seat.
- For children larger than the typical 12-month-old child, the front passenger front air bag may or may not be activated. Always make sure the   indicator

lamp is illuminated, indicating that the front passenger front air bag is deactivated.

- A child in a rear-facing child restraint on the front passenger seat will be seriously injured or even killed if the front passenger front air bag inflates in a collision which could occur under some circumstances, even with the air bag technology installed in your vehicle. The only means to completely eliminate this risk is to never place a child in a rear-facing child restraint in the front seat. We therefore strongly recommend that you always place a child in a rear-facing child restraint in a backseat.
- If you must install a rear-facing child restraint on the front passenger seat because circumstances require you to do so, make sure the   indicator lamp is illuminated, indicating that the front passenger front air bag is deactivated. Should the   indicator lamp not illuminate or go out while the restraint is installed, please check installation. Periodically check the   indicator lamp while driving to make sure the   indicator lamp is illuminated. If the   indicator lamp goes out or remains out, do not transport a child on the front passenger seat until the system has been repaired.

A child in a rear-facing child restraint on the front passenger seat will be seriously injured or even killed if the front passenger front air bag inflates.

- If you have to place a child in a forward-facing child restraint on the front passenger seat, move the seat as far back as possible, use the proper child restraint recommended for the age, size and weight of the child, and secure child restraint with the vehicle's seat belt according to the child seat manufacturer's instructions.

WARNING

If the child restraint system is installed incorrectly on a suitable seat, it cannot

protect as intended. The child cannot then be restrained in the event of an accident, heavy braking or sudden changes of direction. There is an increased risk of injury, possibly even fatal.

Make sure that you observe the child restraint system manufacturer's installation instructions and the notes on use. Please ensure, that the base of the child restraint system is always resting completely on the seat cushion. Never place objects, e.g. cushions, under or behind the child restraint system. Only use child restraint systems with the original cover designed for them. Only replace damaged covers with genuine covers.

WARNING

If the child restraint system is installed incorrectly or is not secured, it can come loose in the event of an accident, heavy braking or a sudden change in direction. The child restraint system could be thrown about, striking vehicle occupants. There is an increased risk of injury, possibly even fatal. Always install child restraint systems properly, even if they are not being used. Make sure that you observe the child restraint system manufacturer's installation instructions.

WARNING

Child restraint systems or their securing systems which have been damaged or subjected to a load in an accident can no longer protect as intended. The child cannot then be restrained in the event of an accident, heavy braking or sudden changes of direction. There is an increased risk of injury, possibly even fatal.

Replace child restraint systems which have been damaged or subjected to a load in an accident as soon as possible. Have the securing systems on the child restraint system checked at a qualified specialist workshop, before you install a child restraint system again.

⚠ WARNING

Infants and small children should never share a seat belt with another occupant. In the event of an accident, they could be crushed between the occupant and seat belt.

A child's risk of serious or fatal injuries is significantly increased if the child restraints are not properly secured in the vehicle and/or the child is not properly secured in the child restraint.

Children that are too large for a child restraint must travel in seats using normal seat belts. Position the shoulder belt across the chest and shoulder, not the face or neck. A booster seat may be necessary to achieve proper seat belt positioning for children over 41 lbs (18 kg) until they reach a height where a lap/shoulder belt fits properly without a booster seat.

When the child restraint is not in use, remove it from the vehicle or secure it with the seat belt to prevent the child restraint from becoming a projectile in the event of an accident.

⚠ WARNING

If children are left unsupervised in the vehicle, they could:

- open the doors, thus endangering other people or road users.
- get out and disrupt traffic.
- operate the vehicle's equipment.

Additionally, children could set the vehicle in motion if, for example, they:

- release the parking brake.
- shifting the automatic transmission out of park position **P**
- Start the engine.

There is a risk of an accident and injury.

When leaving the vehicle, always take the SmartKey with you and lock the vehicle. Never leave children or animals unattended in the vehicle. Always keep the SmartKey out of reach of children.

⚠ WARNING

If persons, particularly children are subjected to prolonged exposure to extreme heat or cold, there is a risk of injury, possibly even fatal. Never leave children unattended in the vehicle.

⚠ WARNING

If the child restraint system is subjected to direct sunlight, parts may get very hot. Children may burn themselves on these parts, particularly on the metal parts of the child restraint system. There is a risk of injury.

If you leave the vehicle, taking the child with you, always ensure that the child restraint system is not exposed to direct sunlight. Protect it with a blanket, for example. If the child restraint system has been exposed to direct sunlight, let it cool down before securing the child in it. Never leave children unattended in the vehicle.

If an infant or child is traveling in the vehicle:

- ▶ Secure the child with a child or infant seat restraint system appropriate to the age and weight of the child.
- ▶ Make sure that the infant or child is properly secured at all times while the vehicle is in motion.

Special seat belt retractor

All seat belts except the driver's seat belt are equipped with a special seat belt retractor. When activated, the special seat belt retractor ensures that the seat belt will not slacken once the child restraint system has been secured.

Installing a child restraint system:

- ▶ Always comply with the manufacturer's installation instructions.
- ▶ Pull the seat belt smoothly from the seat belt retractor.
- ▶ Engage the seat belt tongue in the belt buckle.

Activating the special seat belt retractor:

- ▶ Pull the seat belt out fully and let the seat belt retractor retract it again. While the seat belt is retracting, you should hear a ratcheting sound. The special seat belt retractor is activated.
- ▶ Push down on the child restraint system to take up any slack.

Removing a child restraint system/
deactivating the special seat belt retractor:

- ▶ Always comply with the manufacturer's installation instructions.
- ▶ Press the seat belt release button and guide the belt tongue to the belt outlet. The special seat belt retractor is deactivated.

⚠ WARNING

Never release the seat belt buckle while the vehicle is in motion, since the special seat belt retractor will be deactivated.

LATCH-type (ISOFIX) child seat anchors in the rear

⚠ WARNING

Children that are too large for a child restraint must travel in seats using normal seat belts. Position shoulder belt across the chest and shoulder, not face or neck.

A booster seat may be necessary to achieve proper seat belt positioning for children over 41 lb (18 kg) until they reach a height where a lap/shoulder belt fits properly without a booster.

Install the child restraint system in accordance with the manufacturer's instructions.

Attach the child restraint system to both securing rings.

An incorrectly installed child restraint system could come loose during an accident and seriously or even fatally injure the child.

Child restraint systems or child seat securing rings that are malfunctioning or damaged as the result of a collision must be replaced.

LATCH-type (ISOFIX) is a standardized securing system for specially designed child restraint systems on the rear seats. Securing rings for two LATCH-type (ISOFIX) child restraint systems are installed on the left and right of the rear seats.

Secure non-LATCH-type (ISOFIX) child restraint systems using the vehicle's seat belt system. When installing child restraint systems, you must observe the manufacturer's installation instructions.

- ❗ When installing the child restraint system, make sure that the seat belt for the middle seat does not get trapped. The seat belt could otherwise be damaged.

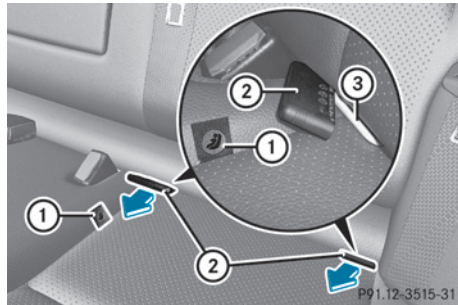

Vehicles without rear-seat through-loading facility
Installation instructions ① indicate the installation location of securing rings ③.

- ▶ Pull protective caps ② from securing rings ③ in the direction of the arrow.

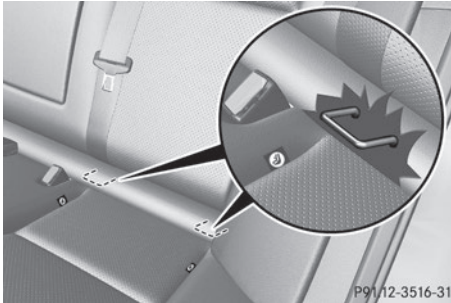

P91.12-3516-31

Vehicles with rear-seat through-loading facility

- ▶ Install the LATCH-type (ISOFIX) child restraint system. Comply with the manufacturer's instructions when installing the LATCH-type (ISOFIX) child restraint system.

Top Tether

WARNING

Always lock the rear seat backrests in their upright position when the rear seats are occupied by passengers. Lock the rear seat backrests in their upright position before installing the Top Tether straps or when the cargo compartment is not in use. Make sure that rear seat backrests are secured properly by pushing and pulling on the seat backrests. If the seat backrest is not locked properly, the seat backrest could fold forward. The child restraint system is no longer supported properly or held in position and can no longer fulfill its function. This could cause serious or even fatal injuries.

Top Tether provides an additional connection between a child restraint system, secured with a LATCH-type (ISOFIX) child seat mount, and the rear seat. This helps reduce the risk of injury even further.

The Top Tether anchorages are located in the rear compartment behind the head restraints.

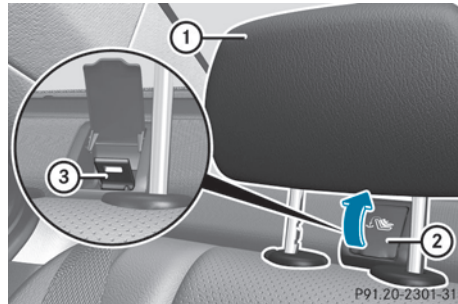

P91.20-2301-31

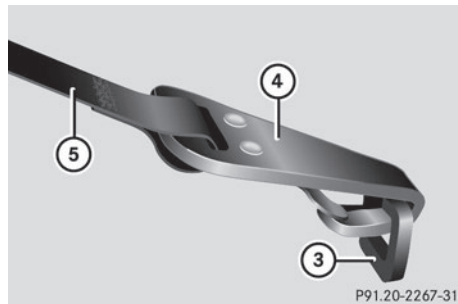

P91.20-2267-31

- ▶ Move head restraint ① upwards.
- ▶ Fold up cover ② of Top Tether anchorage ③.
- ▶ Route Top Tether belt ⑤ under head restraint ① between the two head restraint bars.
- ▶ Hook Top Tether hook ④ into Top Tether anchorage ③.
- ▶ Make sure that Top Tether belt ⑤ is not twisted.
- ▶ Fold down cover ② of Top Tether anchorage ③.
- ▶ Move head restraint ① back down again slightly if necessary (▶ page 102). Make sure that you do not interfere with the correct routing of Top Tether belt ⑤.
- ▶ Install the LATCH-type (ISOFIX) child restraint system with Top Tether. Comply with the manufacturer's installation instructions when doing so. Make sure that Top Tether belt ⑤ is tight.

Child-proof locks

Important safety notes

WARNING

When leaving the vehicle, always remove the SmartKey from the ignition lock. Always take the SmartKey with you and lock the vehicle. Do not leave children unattended in the vehicle, even if they are secured in a child restraint system, or with access to an unlocked vehicle. A child's unsupervised access to a vehicle could result in an accident and/or serious personal injury. The children could:

- injure themselves on parts of the vehicle
- be seriously or fatally injured through excessive exposure to extreme heat or cold
- injure themselves or cause an accident with vehicle equipment that can be operated even if the SmartKey is removed from the ignition lock or removed from the vehicle, such as seat adjustment, steering wheel adjustment, or the memory function

If children open a door, they could injure other persons or get out of the vehicle and injure themselves or be injured by following traffic.

Do not expose the child restraint system to direct sunlight. The child restraint system's metal parts, for example, could become very hot, and the child could be burned on these parts.

Child-proof locks for the rear doors

WARNING

Children could open a rear door from inside the vehicle. This could result in serious injuries or an accident. Therefore, when children ride in the rear always secure the rear doors with the child-proof locks.

You secure each door individually with the child-proof locks on the rear doors. A door secured with a child-proof lock cannot be opened from inside the vehicle. When the

vehicle is unlocked, the door can be opened from the outside.

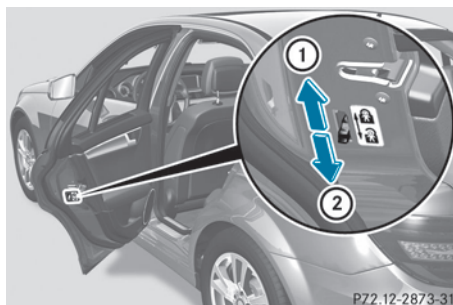

- ▶ **To activate:** press the child-proof lock lever up in the direction of arrow ①.
- ▶ Make sure that the child-proof locks are working properly.
- ▶ **To deactivate:** press the child-proof lock lever down in the direction of arrow ②.

Override feature for the rear side windows

WARNING

When children ride on the vehicle's rear seats, activate the override switch. Otherwise, the children could be injured, e.g. by trapping themselves in the rear side window.

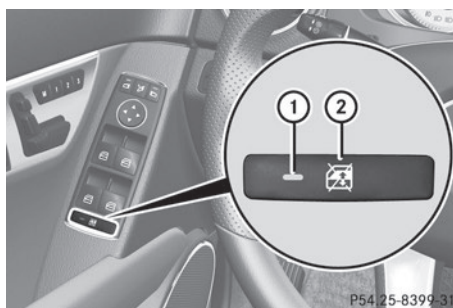

- ▶ **To activate/deactivate:** press button ②. If indicator lamp ① is lit, operation of the rear side windows is disabled. Operation is only possible using the switches in the driver's door. If indicator lamp ① is off,

operation is possible using the switches in the rear compartment.

Driving safety systems

Overview of driving safety systems

In this section, you will find information about the following driving safety systems:

- ABS (**A**nti-**l**ock **B**raking **S**ystem)
- BAS (**B**rake **A**ssist **S**ystem)
- BAS PLUS (**B**rake **A**ssist **S**ystem Plus)
- ESP® (**E**lectronic **S**tability **P**rogram)
- EBD (**E**lectronic **B**rake force **D**istribution)
- ADAPTIVE BRAKE
- PRE-SAFE® Brake

Important safety notes

If you fail to adapt your driving style or become distracted, the driving safety systems can neither reduce the risk of accident nor override the laws of physics. Driving safety systems are merely aids designed to assist driving. You are responsible for the distance to the vehicle in front, for vehicle speed and for braking in good time. Always adapt your driving style to suit the prevailing road, weather and traffic conditions and maintain a safe distance from the vehicle in front. Drive carefully.

- i** The driving safety systems described only work as effectively as possible when there is adequate contact between the tires and the road surface. Please pay special attention to the notes on tires, recommended minimum tire tread depths, etc. (▷ page 314).

In wintry driving conditions, always use winter tires (M+S tires) and if necessary, snow chains. Only in this way will the driving safety systems described in this section work as effectively as possible.

ABS (Anti-lock Braking System)

General information

ABS regulates brake pressure in such a way that the wheels do not lock when you brake. This allows you to continue steering the vehicle when braking.

The yellow  ABS warning lamp in the instrument cluster lights up when the ignition is switched on. It goes out when the engine is running.

Important safety notes

- i** Observe the "Important safety notes" section (▷ page 65).

WARNING

If ABS is faulty, the wheels could lock when braking. The steerability and braking characteristics may be severely impaired. Additionally, further driving safety systems are deactivated. There is an increased danger of skidding and accidents.

Drive on carefully. Have ABS checked immediately at a qualified specialist workshop.

When ABS is malfunctioning, other systems, including driving safety systems, will also become inoperative. Observe the information on the ABS warning lamp (▷ page 250) and display messages which may be shown in the instrument cluster (▷ page 223).

ABS works from a speed of about 5 mph (8 km/h), regardless of road-surface conditions. ABS works on slippery surfaces, even if you only brake gently.

Braking

- **If ABS intervenes:** continue to depress the brake pedal vigorously until the braking situation is over.
- **To make a full brake application:** depress the brake pedal with full force.

If ABS intervenes when braking, you will feel a pulsing in the brake pedal.

The pulsating brake pedal can be an indication of hazardous road conditions, and functions as a reminder to take extra care while driving.

BAS (Brake Assist System)

General information

BAS operates in emergency braking situations. If you depress the brake pedal quickly, BAS automatically boosts the braking force, thus shortening the stopping distance.

Important safety notes

-  Observe the "Important safety notes" section (▷ page 65).

WARNING

If BAS is malfunctioning, the braking distance in an emergency braking situation is increased. There is a risk of an accident.

In an emergency braking situation, depress the brake pedal with full force. ABS prevents the wheels from locking.

Braking

- ▶ Keep the brake pedal firmly depressed until the emergency braking situation is over. ABS prevents the wheels from locking.

The brakes will function as usual once you release the brake pedal. BAS is deactivated.

BAS PLUS (Brake Assist System PLUS)

General information

-  Observe the "Important safety notes" section (▷ page 65).

BAS PLUS is only available in vehicles equipped with DISTRONIC PLUS.

For BAS PLUS to assist you, the radar sensor system must be operational.

With the help of the radar sensor system, BAS PLUS can detect obstacles that are in the path of your vehicle for an extended period of time.

If the radar sensor system is malfunctioning, BAS PLUS will not be available. The brake system is still available with complete brake boosting effect and BAS.

BAS PLUS can help you to minimize the risk of a collision with a vehicle or reduce the effects of such a collision. If BAS PLUS detects a danger of collision, you are assisted when braking.

Important safety notes

WARNING

BAS PLUS cannot always clearly identify objects and complex traffic situations.

In such cases, BAS PLUS may:

- intervene unnecessarily
- not intervene

There is a risk of an accident.

Always pay careful attention to the traffic situation and be ready to brake. Terminate the intervention in a non-critical driving situation.

WARNING

BAS PLUS does not react:

- to people or animals
- to oncoming vehicles
- to crossing traffic
- when cornering

As a result, BAS PLUS may not intervene in all critical situations. There is a risk of an accident.

Always pay careful attention to the traffic situation and be ready to brake.

In the event of snowfall or heavy rain, the recognition can be impaired.

Recognition by the radar sensor system is also impaired in the event of:

- dirt on the sensors or anything else covering the sensors
- interference by other radar sources
- there are strong radar reflections, for example in parking garages
- a narrow vehicle traveling in front, e.g. a motorbike
- a vehicle traveling in front on a different line relative to the center of your vehicle

Following damage to the front end of the vehicle, have the configuration and operation of the radar sensors checked at a qualified specialist workshop. This also applies to collisions at low speeds where there is no visible damage to the front of the vehicle.

Function

To avoid a collision, BAS PLUS calculates the brake force necessary if:

- you approach an obstacle, and
- BAS PLUS has detected a risk of collision

When driving at a speed under 20 mph (30 km/h): if you depress the brake pedal, BAS PLUS is activated. The increase in brake pressure will be carried out at the last possible moment.

When driving at a speed above 20 mph (30 km/h): if you depress the brake pedal sharply, BAS PLUS automatically raises the brake pressure to a value adapted to the traffic situation.

BAS PLUS provides braking assistance in hazardous situations with vehicles in front within a speed range between 4 mph (7 km/h) and 155 mph (250 km/h).

At speeds of up to approximately 40 mph (70 km/h), BAS PLUS can also react to stationary objects. Examples of stationary objects are stopped or parked vehicles.

- If BAS PLUS demands particularly high braking force, preventative passenger

protection measures (PRE-SAFE®) are activated simultaneously.

- ▶ Keep the brake pedal depressed until the emergency braking situation is over. ABS prevents the wheels from locking.

BAS PLUS is deactivated and the brakes function as usual again, if:

- you release the brake pedal
- there is no longer a risk of collision
- no obstacle is detected in front of your vehicle

ESP® (Electronic Stability Program)

General notes

- Observe the "Important safety notes" section (▷ page 65).

ESP® monitors driving stability and traction, i.e. power transmission between the tires and the road surface.

If ESP® detects that the vehicle is deviating from the direction desired by the driver, one or more wheels are braked to stabilize the vehicle. The engine output is also modified to keep the vehicle on the desired course within physical limits. ESP® assists the driver when pulling away on wet or slippery roads. ESP® can also stabilize the vehicle during braking.

ETS/4ETS (Electronic Traction System)

- Observe the "Important safety notes" section (▷ page 65).

ETS/4ETS traction control is part of ESP®.

Traction control brakes the drive wheels individually if they spin. This enables you to pull away and accelerate on slippery surfaces, for example if the road surface is slippery on one side. In addition, more drive torque is transferred to the wheel or wheels with traction.

Traction control remains active, even if you deactivate ESP®.

Important safety notes

i Observe the "Important safety notes" section (▷ page 65).

WARNING

If ESP® is malfunctioning, ESP® is unable to stabilize the vehicle. Additionally, further driving safety systems are deactivated. This increases the risk of skidding and an accident.



Drive on carefully. Have ESP® checked at a qualified specialist workshop.

! When testing the electric parking brake on a braking dynamometer, switch off the ignition. Application of the brakes by ESP® may otherwise destroy the brake system.

Vehicles without 4MATIC: observe the notes on ESP® (▷ page 309) when towing the vehicle with a raised rear axle.

! Vehicles with 4MATIC: function or performance tests may only be carried out on a 2-axle dynamometer. Before you operate the vehicle on such a dynamometer, please consult a qualified workshop. You could otherwise damage the drive train or the brake system.

ESP® is deactivated if the  warning lamp in the instrument cluster lights up continuously when the engine is running.

If the  warning lamp and the  warning lamp are lit continuously, ESP® is not available due to a malfunction.

Observe the information on warning lamps (▷ page 252) and display messages which may be shown in the instrument cluster (▷ page 223).

i Only use wheels with the recommended tire sizes. Only then will ESP® function properly.

Characteristics of ESP

General information

If the  ESP warning lamp goes out before beginning the journey, ESP® is automatically active.

If ESP® intervenes, the  ESP® warning lamp flashes in the instrument cluster.

If ESP® intervenes:

- ▶ Do not deactivate ESP® under any circumstances.
- ▶ Only depress the accelerator pedal as far as necessary when pulling away.
- ▶ Adapt your driving style to suit the prevailing road and weather conditions.

ECO start/stop function

The ECO start/stop function switches the engine off automatically when the vehicle stops moving. The engine starts automatically when the driver wants to pull away again. ESP® remains in its previously selected status. **Example:** if ESP® was deactivated before the engine was switched off, ESP® remains deactivated when the engine is switched on again.

Deactivating/activating ESP® (except AMG vehicles)

Important safety notes

i Observe the "Important safety notes" section (▷ page 65).

You can select between the following statuses of ESP:

- ESP® is activated.
- ESP® is deactivated.

WARNING

If you deactivate ESP®, ESP® no longer stabilizes the vehicle. There is an increased risk of skidding and an accident.

Only deactivate ESP® in the situations described in the following.

It may be best to deactivate ESP® in the following situations:

- when using snow chains
- in deep snow
- on sand or gravel

i Activate ESP® as soon as the situations described above no longer apply. ESP® will otherwise not be able to stabilize the vehicle if the vehicle starts to skid or a wheel starts to spin.

Deactivating/activating ESP®

You can activate and deactivate ESP® using the on-board computer.

▶ **To deactivate:** (▷ page 213).

The  ESP® OFF warning lamp in the instrument cluster lights up.

▶ **To activate:** (▷ page 213).

The  ESP® OFF warning lamp in the instrument cluster goes out.

Characteristics when ESP® is deactivated

If ESP® is deactivated and one or more wheels start to spin, the  ESP® warning lamp in the instrument cluster flashes. In such situations, ESP® will not stabilize the vehicle.

If you deactivate ESP®:

- ESP® no longer improves driving stability.
- engine torque is no longer limited and the drive wheels are able to spin.

The spinning of the wheels results in a cutting action for better traction on loose surfaces.

- traction control is still activated.
- ESP® still provides support when you brake.

Deactivating/activating ESP® (AMG vehicles)

Important safety notes

You can select between the following statuses of ESP:

- ESP® is activated.
- SPORT handling mode is activated.
- ESP® is deactivated.

WARNING

When SPORT handling mode is activated, there is a greater risk of skidding and accidents.

Only activate SPORT handling mode in the situations described in the following.

WARNING

If you deactivate ESP®, ESP® no longer stabilizes the vehicle. There is an increased risk of skidding and an accident.

Only deactivate ESP® in the situations described in the following.

! Avoid spinning the driven wheels for an extended period with ESP® deactivated. You could otherwise damage the drivetrain.

In the following situations, it may be better to activate SPORT handling mode or deactivate ESP®:

- when using snow chains
- in deep snow
- on sand or gravel
- on designated roads when the vehicle's own oversteering and understeering characteristics are desired

Driving in SPORT handling mode or without ESP® requires an extremely qualified and experienced driver.

i Activate ESP® as soon as the situations described above no longer apply. ESP® will otherwise not be able to stabilize the vehicle if the vehicle starts to skid or a wheel starts to spin.

Deactivating/activating ESP®



► To activate SPORT handling mode:

briefly press button ①.

The **SPORT** SPORT handling mode warning lamp in the instrument cluster lights up. The **SPORT handling mode** message appears in the multifunction display.

► To deactivate SPORT handling mode:

briefly press button ①.

The **SPORT** SPORT handling mode warning lamp in the instrument cluster goes out.

► To deactivate ESP®: press button ① until

the **ESP OFF** ESP® OFF warning lamp lights up in the instrument cluster.

The **ESP OFF** message appears in the multifunction display.

► To activate ESP®: briefly press button ①.

The **ESP OFF** ESP® OFF warning lamp in the instrument cluster goes out. The **ESP ON** message appears in the multifunction display.

Characteristics of activated SPORT handling mode

If SPORT handling mode is activated and one or more wheels start to spin, the **ESP** ESP® warning lamp in the instrument cluster flashes. ESP® only stabilizes the vehicle to a limited degree.

When SPORT handling mode is activated:

- ESP® only improves driving stability to a limited degree.
- traction control is still activated.

- engine torque is only restricted to a limited degree, and the drive wheels are able to spin.

The spinning of the wheels results in a cutting action for better traction on loose surfaces.

- ESP® still provides support when you brake.

Characteristics when ESP® is deactivated

If ESP® is deactivated and one or more wheels start to spin, the **ESP** ESP® warning lamp in the instrument cluster does not flash. In such situations, ESP® will not stabilize the vehicle.

If you deactivate ESP®:

- ESP® no longer improves driving stability.
- engine torque is restricted to a limited degree and the drive wheels are able to spin.

The spinning of the wheels results in a cutting action for better traction on loose surfaces.
- traction control is still activated.
- PRE-SAFE® is no longer available, nor is it activated if you brake firmly and ESP® intervenes.
- PRE-SAFE® Brake is no longer available, it is also not activated if you brake firmly and ESP® intervenes.
- ESP® still provides support when you brake.

EBD (electronic brake force distribution)

General information

EBD monitors and controls the brake pressure on the rear wheels to improve driving stability while braking.

Important safety notes

- ① Observe the "Important safety notes" section (► page 65).

⚠ WARNING

If EBD has malfunctioned, the rear wheels can still lock, e.g. under full braking. This increases the risk of skidding and an accident.

You should therefore adapt your driving style to the different handling characteristics. Have the brake system checked at a qualified specialist workshop.

Observe information regarding indicator and warning lamps (▷ page 250) as well as display messages (▷ page 224).

ADAPTIVE BRAKE

ADAPTIVE BRAKE enhances braking safety and offers increased braking comfort. In addition to the braking function, ADAPTIVE BRAKE also has the HOLD function (▷ page 182) and hill start assist (▷ page 150). For further information, see "Driving tips" (▷ page 168).

PRE-SAFE® Brake**General information**

- ⓘ Observe the "Important safety notes" section (▷ page 65).

PRE-SAFE® Brake is only available in vehicles with DISTRONIC PLUS.

For PRE-SAFE® Brake to assist you when driving, the radar sensor system must be operational.

With the help of the radar sensor system, PRE-SAFE® Brake can detect obstacles that are in front of your vehicle for an extended period of time.

PRE-SAFE® Brake can help you to minimize the risk of a collision with a vehicle ahead, and reduce the effects of such a collision. If PRE-SAFE® Brake has detected a risk of collision, you will be warned visually and acoustically as well as by automatic braking. PRE-SAFE®

Brake cannot prevent a collision without your intervention.

Important safety notes**⚠ WARNING**

PRE-SAFE® Brake will initially brake your vehicle by a partial application of the brakes if a danger of collision is detected. There may be a collision unless you also brake.

Automatic emergency braking cannot prevent a collision. There is a risk of an accident.

Always apply the brakes yourself and try to take evasive action.

⚠ WARNING

PRE-SAFE® Brake cannot always clearly identify objects and complex traffic conditions.

In these cases, PRE-SAFE® Brake may:

- give an unnecessary warning and then brake the vehicle
- not give a warning or intervene

There is a risk of an accident.

Always pay particular attention to the traffic situation and be ready to brake, especially if PRE-SAFE® Brake warns you. Terminate the intervention in a non-critical driving situation.

In order to maintain the appropriate distance to the vehicle in front and thus prevent a collision, you must apply the brakes yourself.

⚠ WARNING

PRE-SAFE® Brake does not react:

- to people or animals
- to oncoming vehicles
- to crossing traffic
- when cornering

As a result, PRE-SAFE® Brake may neither give warnings nor intervene in all critical situations. There is a risk of an accident.

Always pay careful attention to the traffic situation and be ready to brake.

In the event of snowfall or heavy rain, the recognition can be impaired.

Recognition by the radar sensor system is also impaired in the event of:

- dirt on the sensors or anything else covering the sensors
- interference by other radar sources
- there are strong radar reflections, for example in parking garages
- a narrow vehicle traveling in front, e.g. a motorbike
- a vehicle traveling in front on a different line relative to the center of your vehicle

Following damage to the front end of the vehicle, have the configuration and operation of the radar sensors checked at a qualified specialist workshop. This also applies to collisions at low speeds where there is no visible damage to the front of the vehicle.

Function

- ▶ **To activate/deactivate:** activate or deactivate PRE-SAFE® Brake in the on-board computer (> page 214).

If the PRE-SAFE® Brake is not activated, the  symbol appears in the multifunction display.

Starting at a speed of around 4 mph (7 km/h), this function warns you if you rapidly approach a vehicle in front. An intermittent warning tone will then sound and the  distance warning lamp will light up in the instrument cluster.

- ▶ Brake immediately to defuse the situation.
- or
- ▶ Take evasive action provided it is safe to do so.

PRE-SAFE® Brake can also brake the vehicle automatically under the following conditions:

- the driver and front-passenger have their seat belts fastened

and

- the vehicle speed is between approximately 4 mph (7 km/h) and 124 mph (200 km/h)

At speeds of up to approximately 40 mph (70 km/h) PRE-SAFE® Brake can also detect stationary objects. Examples of stationary objects are stopped or parked vehicles.

- i** If there is an increased risk of collision, preventive passenger protection measures (PRE-SAFE®) are activated.

If the risk of collision with the vehicle in front remains and you do not brake, take evasive action or accelerate significantly, the vehicle may perform automatic emergency braking, up to the point of full brake application. Automatic emergency braking is not performed until immediately prior to an imminent accident.

You can prevent the intervention of the PRE-SAFE® Brake at any time by:

- depressing the accelerator pedal further.
- activating kickdown.
- releasing the brake pedal.

The braking action of PRE-SAFE® Brake is ended automatically if:

- you maneuver to avoid the obstacle.
- there is no longer any danger of a rear-end collision.
- there is no longer an obstacle detected in front of your vehicle.

Theft deterrent locking system

Immobilizer

The immobilizer prevents your vehicle from being started without the correct SmartKey. When leaving the vehicle, always take the SmartKey with you and lock the vehicle. The engine can be started by anyone with a valid SmartKey that is left inside the vehicle.

- ▶ **To activate with the SmartKey:** remove the SmartKey from the ignition lock.
- ▶ **To activate with KEYLESS-GO:** switch the ignition off and open the driver's door.
- ▶ **To deactivate:** switch on the ignition.

i The immobilizer is always deactivated when you start the engine.

In the event that the engine cannot be started when the starter battery is fully charged, the immobilizer may be faulty. Contact an authorized Mercedes-Benz Center or call 1-800-FOR-MERCEDES (in the USA) or 1-800-387-0100 (in Canada).

ATA (anti-theft alarm system)

A visual and audible alarm is triggered if the alarm system is armed and you open:

- a door
- the vehicle with the mechanical key
- the trunk lid
- the hood

The alarm is not switched off, even if you close the open door that triggered it, for example.

i If the alarm continues for more than 30 seconds, the mbrace emergency call system automatically notifies the Customer Assistance Center. This is done either by text message or data connection. The emergency call system sends the message or data provided that:

- you have subscribed to the mbrace service.
- the mbrace service has been activated properly.
- the necessary mobile phone network is available.





▶ **To arm:** lock the vehicle with the SmartKey or KEYLESS-GO. Indicator lamp ① flashes. The alarm system is armed after approximately 15 seconds.

▶ **To disarm:** unlock the vehicle with the SmartKey or KEYLESS-GO.

▶ **To stop the alarm using the SmartKey:** insert the SmartKey into the ignition lock. The alarm is switched off.

or

▶ Press the  or  button on the SmartKey. The alarm is switched off.

▶ **To stop the alarm using KEYLESS-GO:** grasp the outside door handle. The SmartKey must be outside the vehicle. The alarm is switched off.

or

▶ Press the Start/Stop button on the dashboard. The SmartKey must be inside the vehicle. The alarm is switched off.

Useful information	76
SmartKey	76
Doors	81
Trunk	84
Side windows	87
Sliding sunroof	91

Useful information

- i** This Operator's Manual describes all models and all standard and optional equipment of your vehicle available at the time of publication of the Operator's Manual. Country-specific differences are possible. Please note that your vehicle may not be equipped with all features described. This also applies to safety-related systems and functions.
- i** Read the information on qualified specialist workshops: (▷ page 25).

SmartKey

Important safety notes

WARNING

If children are left unsupervised in the vehicle, they could:

- open the doors, thus endangering other people or road users.
- get out and disrupt traffic.
- operate the vehicle's equipment.

Additionally, children could set the vehicle in motion if, for example, they:

- release the parking brake.
- shifting the automatic transmission out of park position **P**
- Start the engine.

There is a risk of an accident and injury.

When leaving the vehicle, always take the SmartKey with you and lock the vehicle. Never leave children or animals unattended in the vehicle. Always keep the SmartKey out of reach of children.

WARNING

If persons, particularly children are subjected to prolonged exposure to extreme heat or cold, there is a risk of injury, possibly even fatal. Never leave children unattended in the vehicle.

WARNING

If you attach heavy or large objects to the SmartKey, the SmartKey could be unintentionally turned in the ignition lock. This could cause the engine to be switched off. There is a risk of an accident.

Do not attach any heavy or large objects to the SmartKey. Remove any bulky key rings before inserting the SmartKey into the ignition lock.

- !** Keep the SmartKey away from strong magnetic fields. Otherwise, the remote control function could be affected. Strong magnetic fields can occur in the vicinity of powerful electrical installations.

- Do not keep the KEYLESS-GO key:
 - with electronic devices, e.g. a mobile phone or another SmartKey
 - with metallic objects, e.g. coins or metal foil
 - inside metallic objects e.g. a metal case
 This can affect the functionality of the SmartKey.

SmartKey functions

The SmartKey centrally locks/unlocks:

- the doors
- the trunk lid
- the fuel filler flap

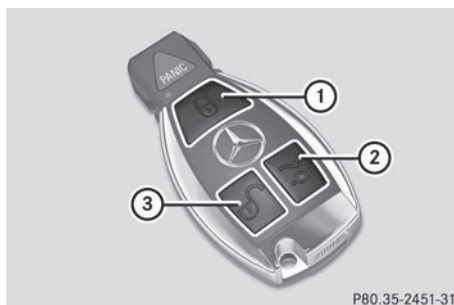

P80.35-2451-31

- ① To lock the vehicle
- ② To unlock the trunk lid
- ③ To unlock the vehicle

The turn signals flash once when unlocking and three times when locking.

When it is dark, the surround lighting also comes on if it is activated in the on-board computer (▷ page 216).

You can also set an audible signal to confirm that the vehicle has been locked. The audible signal can be activated and deactivated using the on-board computer (▷ page 217).

► **To unlock centrally:** press the button.

If you do not open the vehicle within approximately 40 seconds of unlocking:

- the vehicle is locked again.
- the theft deterrent locking system is armed again.

► **To lock centrally:** press the button.

KEYLESS-GO

General notes

Bear in mind that the engine can be started by any of the vehicle occupants if there is a KEYLESS-GO key in the vehicle.

Locking/unlocking centrally

You can start, lock or unlock the vehicle using KEYLESS-GO. To do this, you only need carry the SmartKey with you. You can combine the

functions of KEYLESS-GO with those of a conventional SmartKey. Unlock the vehicle by using KEYLESS-GO, for instance, and lock it using the button on the SmartKey.

When locking or unlocking with KEYLESS-GO, the distance between the key and the corresponding door handle must not be greater than 3 ft (1 m).

KEYLESS-GO checks whether a valid SmartKey is in the vehicle by periodically establishing a radio connection between the vehicle and the SmartKey. This happens:

- when the external door handles are touched
- when starting the engine
- while the vehicle is in motion

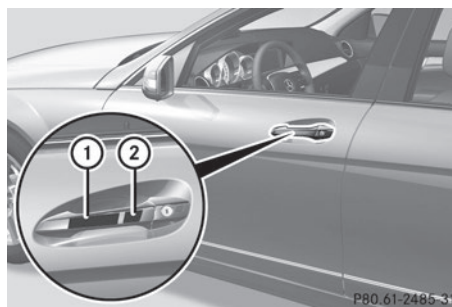

P80.61-2485-31

► **To unlock the vehicle:** touch the inner surface of the door handle.

► **To lock the vehicle:** touch sensor surface ①.

► **Convenience closing feature:** touch recessed sensor surface ② for an extended period.



Further information on the convenience closing feature (▷ page 90).



If you pull on the handle of the trunk lid, only the trunk of the vehicle is unlocked.

Changing the settings of the locking system

You can change the settings of the locking system. This means that only the driver's door and the fuel filler flap are unlocked when the



vehicle is unlocked. This is useful if you frequently travel on your own.

- ▶ **To change the setting:** press and hold down the  and  buttons simultaneously for approximately six seconds until the battery check lamp (> page 79) flashes twice.



i If the setting of the locking system is changed within the signal range of the vehicle, pressing the  or  button:

- locks or
- unlocks the vehicle

The SmartKey now functions as follows:

- ▶ **To unlock the driver's door:** press the  button once.
- ▶ **To unlock centrally:** press the  button twice.
- ▶ **To lock centrally:** press the  button.

The KEYLESS-GO function is changed as follows:

- ▶ **To unlock the driver's door:** touch the inner surface of the door handle on the driver's door.
- ▶ **To unlock centrally:** touch the inner surface of the door handle on the front-passenger door or the rear door.
- ▶ **To lock centrally:** touch the outer sensor surface on one of the door handles (> page 77).
- ▶ **To restore the factory settings:** press and hold down the  and  buttons simultaneously for approximately six seconds until the battery check lamp flashes twice.

Mechanical key

General notes

If the vehicle can no longer be locked or unlocked with the SmartKey or the KEYLESS-GO key, use the mechanical key.

If you use the mechanical key to unlock and open the driver's door or the trunk lid, the anti-theft alarm system will be triggered (> page 73).

- ▶ **To end the alarm:** insert the SmartKey into the ignition lock.

i **With KEYLESS-GO:** remove the Start/Stop button from the ignition lock beforehand.

If you unlock the vehicle using the mechanical key, the fuel filler flap will not be unlocked automatically.

- ▶ **To unlock the fuel filler flap:** insert the SmartKey into the ignition lock.

Removing the mechanical key

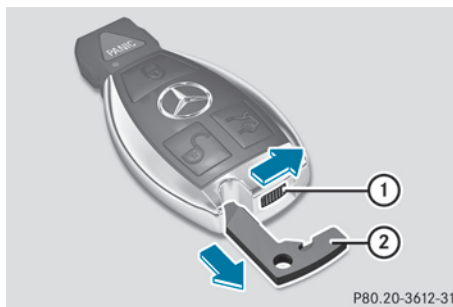

P80.20-3612-31

- ▶ Push release catch ① in the direction of the arrow and at the same time remove mechanical key ② from the SmartKey.

SmartKey battery

Important safety notes

Mercedes-Benz recommends that you have the batteries replaced at a qualified specialist workshop.



WARNING



Batteries contain toxic and corrosive substances. If batteries are swallowed, it can result in severe health problems. There is a risk of fatal injury.

Keep batteries out of the reach of children. If a battery is swallowed, seek medical attention immediately.

Checking the battery



- ▶ Press the  or  button. The battery is working properly if battery check lamp ① lights up briefly. If battery check lamp ① does not light up briefly during the test, the battery is discharged.

i If the SmartKey battery is checked within the signal reception range of the vehicle, pressing the  or  button:

- locks or
 - unlocks the vehicle
- ▶ Change the battery (▷ page 79).

i You can get a battery at a qualified specialist workshop.

Replacing the battery

You require a CR 2025 3 V cell battery.

- ▶ Take the mechanical key out of the SmartKey (▷ page 78).

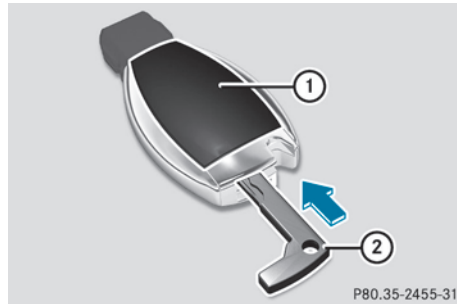

- ▶ Press mechanical key ② into the SmartKey opening in the direction of the arrow until battery compartment cover ① opens. Do not hold battery compartment cover ① closed while doing so.

- ▶ Remove battery compartment cover ①.

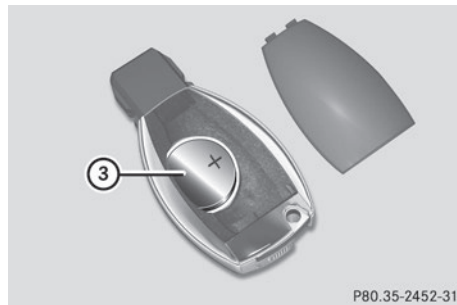

- ▶ Repeatedly tap the SmartKey against your palm until battery ③ falls out.

- ▶ Insert the new battery with the positive terminal facing upwards. Use a lint-free cloth to do so.







- ▶ Make sure that the surface of the battery is free from lint, grease and all other forms of contamination.

- ▶ Insert the front tabs of battery compartment cover ① into the housing first and then press to close it.

- ▶ Insert mechanical key ② into the SmartKey.

- ▶ Check the function of all SmartKey buttons on the vehicle.

Problems with the SmartKey

Problem	Possible causes/consequences and ► Solutions
<p>You cannot lock or unlock the vehicle using the SmartKey.</p>	<p>The SmartKey battery is discharged or nearly discharged.</p> <ul style="list-style-type: none"> ► Try again to lock/unlock the vehicle using the remote control function of the SmartKey. Point the tip of the SmartKey at the driver's door handle from close range and press the  or  button. <p>If this does not work:</p> <ul style="list-style-type: none"> ► Check the SmartKey battery (▷ page 79) and replace it if necessary (▷ page 79). ► Lock (▷ page 83) or unlock (▷ page 83) the vehicle using the mechanical key. <p>The SmartKey is faulty.</p> <ul style="list-style-type: none"> ► Lock (▷ page 83) or unlock (▷ page 83) the vehicle using the mechanical key. ► Have the SmartKey checked at a qualified specialist workshop.
<p>You can no longer lock or unlock the vehicle using KEYLESS-GO.</p>	<p>There is interference from a powerful source of radio waves.</p> <ul style="list-style-type: none"> ► Lock/unlock the vehicle using the remote control function of the SmartKey. Point the tip of the SmartKey at the driver's door handle from close range and press the  /  button. <p>There is a malfunction with KEYLESS-GO.</p> <ul style="list-style-type: none"> ► Lock/unlock the vehicle using the remote control function of the SmartKey. Point the tip of the SmartKey at the driver's door handle from close range and press the  /  button. ► Have KEYLESS-GO checked at a qualified specialist workshop. <p>If this does not work:</p> <ul style="list-style-type: none"> ► Check the SmartKey battery (▷ page 79) and replace it if necessary (▷ page 79). ► Lock (▷ page 83) or unlock (▷ page 83) the vehicle using the mechanical key.
<p>You have lost a SmartKey.</p>	<ul style="list-style-type: none"> ► Have the SmartKey deactivated at a qualified specialist workshop. ► Report the loss immediately to the vehicle insurers. ► If necessary, have the locks changed as well.
<p>You have lost the mechanical key.</p>	<ul style="list-style-type: none"> ► Report the loss immediately to the vehicle insurers. ► If necessary, have the locks changed as well.

Problem	Possible causes/consequences and ► Solutions
The engine cannot be started using the SmartKey.	<p>The on-board voltage is too low.</p> <ul style="list-style-type: none"> ► Switch off non-essential consumers, e.g. seat heating or interior lighting, and try to start the engine again. <p>If this does not work:</p> <ul style="list-style-type: none"> ► Check the starter battery and charge it if necessary (▷ page 302). <p>or</p> <ul style="list-style-type: none"> ► Jump-start the vehicle (▷ page 306). <p>or</p> <ul style="list-style-type: none"> ► Consult a qualified specialist workshop.
The engine cannot be started using the SmartKey.	<p>The steering lock is mechanically blocked.</p> <ul style="list-style-type: none"> ► Remove the SmartKey and reinsert it into the ignition lock. While doing this, turn the steering wheel in both directions.
The engine cannot be started using KEYLESS-GO. The SmartKey is in the vehicle.	<p>A door is open. Therefore, the SmartKey cannot be detected as easily.</p> <ul style="list-style-type: none"> ► Close the door and try to start the vehicle again. <p>There is interference from a powerful source of radio waves.</p> <ul style="list-style-type: none"> ► Start your vehicle with the SmartKey in the ignition lock.

Doors

Important safety notes

WARNING

If children are left unsupervised in the vehicle, they could:

- open the doors, thus endangering other people or road users.
- get out and disrupt traffic.
- operate the vehicle's equipment.

Additionally, children could set the vehicle in motion if, for example, they:

- release the parking brake.
- shifting the automatic transmission out of park position **P**
- Start the engine.

There is a risk of an accident and injury.

When leaving the vehicle, always take the SmartKey with you and lock the vehicle. Never leave children or animals unattended in the vehicle. Always keep the SmartKey out of reach of children.

WARNING

If persons, particularly children are subjected to prolonged exposure to extreme heat or cold, there is a risk of injury, possibly even fatal. Never leave children unattended in the vehicle.

You should preferably place luggage or loads in the cargo compartment. Observe the loading guidelines (▷ page 262).

Unlocking and opening doors from the inside

You can open a door from inside the vehicle even if it has been locked. You can only open the rear doors from inside the vehicle if they are not secured by the child-proof locks (▷ page 64).

Only open the door when the traffic situation permits.

If the vehicle has been locked with the SmartKey or with KEYLESS-GO, opening a door from the inside will trigger the anti-theft alarm system. Switch off the alarm (▷ page 73).

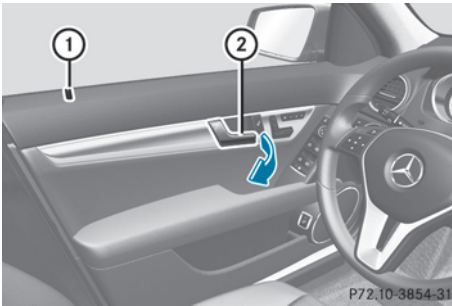

- ▶ **To unlock a front door:** pull door handle ②.
Locking knob ① pops up.
The door is unlocked and can be opened.
- ▶ **To open a front door:** pull door handle ②.
- ▶ **To unlock a rear door:** pull up locking knob ①.
The door is unlocked and can be opened.
- ▶ **To open a rear door:** pull door handle ②.

Centrally locking and unlocking the vehicle from the inside

You can centrally lock or unlock the vehicle from the inside.

You cannot unlock the vehicle centrally from the inside if the vehicle has been locked with the SmartKey or KEYLESS-GO.

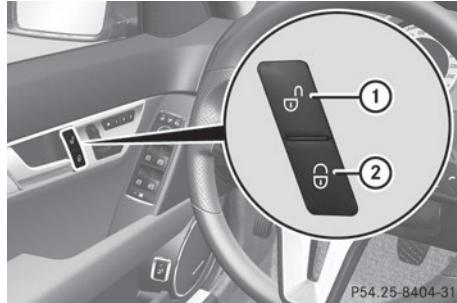

▶ **To unlock:** press button ①.

▶ **To lock:** press button ②.

If the front-passenger door is closed, the vehicle locks.

Meanwhile, the fuel filler flap will not be locked or unlocked.

You can open a door from inside the vehicle even if it has been locked. You can only open the rear doors from inside the vehicle if they are not secured by the child-proof locks (▷ page 64).

Only open the door when the traffic situation permits.

If the vehicle was previously locked with the SmartKey or with KEYLESS-GO, opening the vehicle from the inside will activate the anti-theft alarm system. Switch off the alarm (▷ page 73).

If the vehicle has been locked using the locking button for the central locking, or has been locked automatically, and a door is opened from the inside:

- the vehicle will be fully unlocked if it had previously been fully unlocked
- only the door which has been opened from the inside is unlocked if only the driver's door had been previously unlocked

If the vehicle has been locked centrally with the SmartKey or with KEYLESS-GO, it is not unlocked when the release button for the central locking is used.

Automatic locking feature

The vehicle is locked automatically when the ignition is switched on and the vehicle's wheels are turning at a speed in excess of 9 mph (15 km/h).

You could therefore be locked out if:

- the vehicle is being pushed.
- the vehicle is being towed.
- the vehicle is on a roller dynamometer.

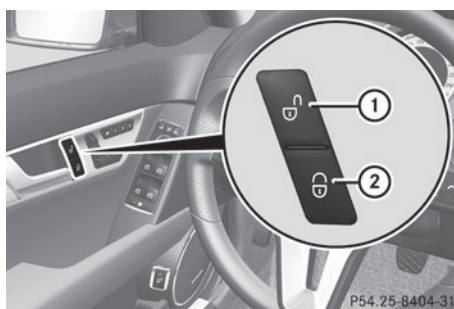

- ▶ **To deactivate:** press and hold button ① for about five seconds until a tone sounds.
- ▶ **To activate:** press and hold button ② for about five seconds until a tone sounds.

i If you press one of the two buttons and do not hear a tone, the relevant setting has already been selected.

You can also switch the automatic locking function on and off using the on-board computer (▷ page 217).

Unlocking the driver's door (mechanical key)

If the vehicle can no longer be unlocked with the SmartKey, use the mechanical key.

If you use the mechanical key to unlock and open the driver's door, the anti-theft alarm system will be triggered (▷ page 73).

- ▶ Take the mechanical key out of the SmartKey (▷ page 78).
- ▶ Insert the mechanical key into the lock of the driver's door as far as it will go.

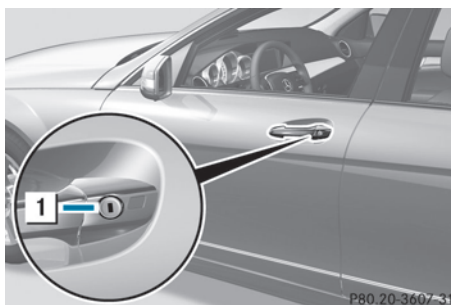

- ▶ Turn the mechanical key counter-clockwise to position 1. The door is unlocked.
- ▶ Turn the mechanical key back and remove it.
- ▶ Insert the mechanical key into the SmartKey.

Locking the vehicle (mechanical key)

If the vehicle can no longer be locked with the SmartKey, use the mechanical key.

- ▶ Open the driver's door.
- ▶ Close the front-passenger door, the rear doors and the trunk lid.
- ▶ Press the locking button (▷ page 82).
- ▶ Check whether the locking knobs on the front-passenger door and the rear doors are still visible. Press down the locking knobs manually, if necessary (▷ page 82).
- ▶ Close the driver's door.
- ▶ Take the mechanical key out of the SmartKey (▷ page 78).
- ▶ Insert the mechanical key into the lock of the driver's door as far as it will go.

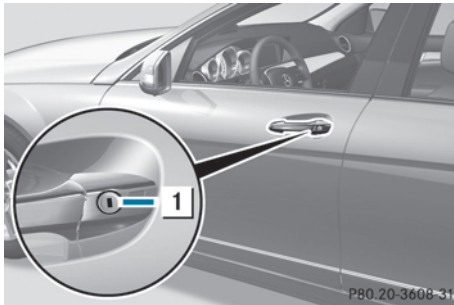

- ▶ Turn the mechanical key clockwise as far as it will go to position **1**.
- ▶ Turn the mechanical key back and remove it.
- ▶ Make sure that the doors and the trunk lid are locked.
- ▶ Insert the mechanical key into the SmartKey.

i If you lock the vehicle as described above, the fuel filler flap is not locked. The anti-theft alarm system is not armed.

Trunk

Important safety notes

⚠ WARNING

If persons, particularly children are subjected to prolonged exposure to extreme heat or cold, there is a risk of injury, possibly even fatal. Never leave children unattended in the vehicle.

⚠ WARNING

Combustion engines emit poisonous exhaust gases such as carbon monoxide. Exhaust gases can enter the vehicle interior if the trunk lid is open when the engine is running, especially if the vehicle is in motion. There is a risk of poisoning.

Always switch off the engine before opening the trunk lid. Never drive with the trunk lid open.

! The trunk lid swings upwards when opened. Therefore, make sure that there is sufficient clearance above the trunk lid.

i Opening dimensions of the trunk lid (▷ page 358).

You should preferably place luggage or loads in the cargo compartment. Observe the loading guidelines (▷ page 262).

Do not leave the SmartKey in the trunk. You could otherwise lock yourself out.

The trunk lid can be:

- opened and closed manually from outside
- opened automatically from outside
- opened automatically from inside
- locked separately
- unlocked with the mechanical key
- opened with the emergency release button

Trunk lid reversing feature

The trunk lid is equipped with an automatic reversing feature. It reacts if a solid object obstructs or restricts the trunk lid during the closing procedure. The trunk lid opens again automatically. The automatic reversing feature is only an aid and is not a substitute for your attentiveness to the trunk lid while it is closing.

⚠ WARNING

The reversing feature does not react:

- to soft, light and thin objects, e.g. small fingers
- over the last 1/3 in(8 mm) of the closing movement

This means that the reversing feature cannot prevent someone being trapped in these situations. There is a risk of injury.

Make sure that no body parts are in close proximity during the closing procedure.

If somebody becomes trapped:

- press the  button on the SmartKey, or
- press the remote operating switch on the driver's door, or
- press the closing or locking button on the trunk lid, or
- pull on the trunk lid handle

Opening/closing from outside

Opening

- ▶ Press the  button on the SmartKey.

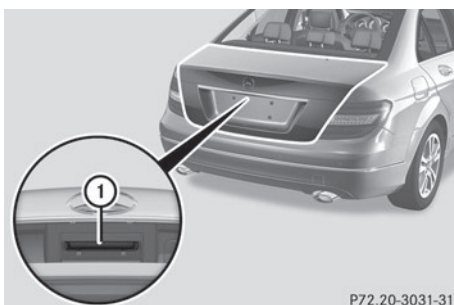

- ▶ Pull handle ①.
- ▶ Raise the trunk lid.

Closing

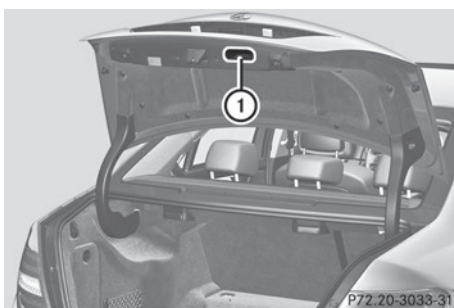

- ▶ Pull the trunk lid down using recess ①.
- ▶ If necessary, lock the vehicle with the  button on the SmartKey (> page 76) or with KEYLESS-GO (> page 77).

- ⓘ If a KEYLESS-GO key is detected in the trunk, the trunk lid cannot be locked and will open again.

Opening automatically from outside

Important safety notes

WARNING

Parts of the body could become trapped during automatic closing of the trunk lid. Moreover, people, e.g. children, may be standing in the closing area or may enter the closing area during the closing process. There is a risk of injury.

Make sure that nobody is in the vicinity of the closing area during the closing process.

Use one of the following options to stop the closing process:

- Press the  button on the key.
- press the remote operating switch on the driver's door.
- Press the closing or locking button on the trunk lid.
- Pull the trunk lid handle.

WARNING

Combustion engines emit poisonous exhaust gases such as carbon monoxide. Exhaust gases can enter the vehicle interior if the trunk lid is open when the engine is running, especially if the vehicle is in motion. There is a risk of poisoning.

Always switch off the engine before opening the trunk lid. Never drive with the trunk lid open.

- ⚠ The trunk lid swings upwards when opened. Therefore, make sure that there is sufficient clearance above the trunk lid.

- ⓘ Opening dimensions of the trunk lid (> page 358).

Opening

You can open the trunk lid automatically using the SmartKey or the handle in the trunk lid.

- ▶ Press and hold the  button on the SmartKey until the trunk lid opens.
- or
- ▶ If the trunk lid is unlocked, pull the trunk lid handle and let it go again immediately.

Opening automatically from inside

WARNING

Combustion engines emit poisonous exhaust gases such as carbon monoxide. Exhaust gases can enter the vehicle interior if the trunk lid is open when the engine is running, especially if the vehicle is in motion. There is a risk of poisoning.

Always switch off the engine before opening the trunk lid. Never drive with the trunk lid open.

- ❗ The trunk lid swings upwards when opened. Therefore, make sure that there is sufficient clearance above the trunk lid.

- i Opening dimensions of the trunk lid (▷ page 358).

You can open the trunk lid from the driver's seat when the vehicle is stationary and unlocked.





- ▶ **To open:** press the upper section of the remote operating switch for trunk lid  until the trunk lid opens.

Locking the trunk separately

You can lock the trunk separately. If you then unlock the vehicle centrally, the trunk remains locked and cannot be opened.

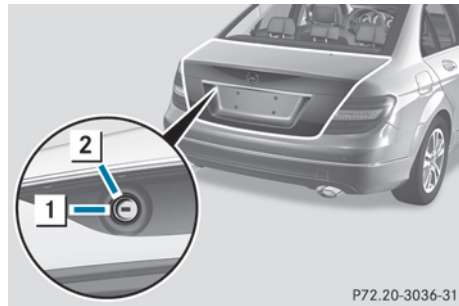
- ▶ Close the trunk lid.
- ▶ Take the mechanical key out of the SmartKey (▷ page 78).



- ▶ Insert the mechanical key into the trunk lid lock as far as the stop.
- ▶ Turn the mechanical key clockwise from position  to position .
- ▶ Remove the mechanical key.
- ▶ Insert the mechanical key into the SmartKey.

Unlocking the trunk (mechanical key)

- ❗ The trunk lid swings upwards when opened. Therefore, make sure that there is sufficient clearance above the trunk lid.

If the trunk cannot be unlocked with the SmartKey or KEYLESS-GO, use the mechanical key.

If you use the mechanical key to unlock and open the trunk lid, the anti-theft alarm system will be triggered (▷ page 73).

- ▶ Take the mechanical key out of the SmartKey (▷ page 78).
- ▶ Insert the mechanical key into the trunk lid lock as far as it will go.

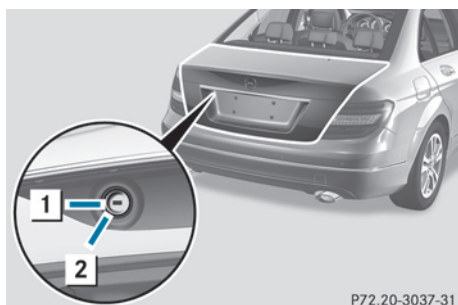

- ▶ Turn the mechanical key counter-clockwise from position [1] as far as it will go to position [2].
The trunk is unlocked.
- ▶ Turn the mechanical key back to position [1] and remove it.
- ▶ Insert the mechanical key into the SmartKey.
- ⓘ When you lock the vehicle (▷ page 83), the trunk is also locked.

Trunk emergency release

You can open the trunk lid from inside the vehicle with the emergency release button.

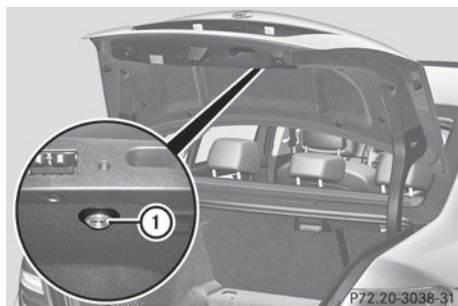

- ▶ Press emergency release button ① briefly.
The trunk lid unlocks and opens.

The trunk lid can be unlocked and opened with the trunk lid emergency release when the vehicle is stationary or while driving.

Trunk lid emergency release light:

- emergency release button ① flashes for 30 minutes after the trunk lid is opened
- emergency release button ① flashes for 60 minutes after the trunk lid is closed

The trunk lid emergency release does not open the trunk lid if the battery is disconnected or discharged.

Side windows

Important safety notes

⚠ WARNING

While opening the side windows, body parts could become trapped between the side window and the door frame as the side window moves. There is a risk of injury.

Make sure that nobody touches the side window during the opening procedure. If somebody becomes trapped, release the switch or pull the switch to close the side window again.

⚠ WARNING

While opening the side windows, body parts in the closing area could become trapped. There is a risk of injury.

Make sure that no body parts are in close proximity during the closing procedure. If somebody becomes trapped, release the switch or press the switch down to open the side window again.

⚠ WARNING

If children operate the side windows they could become trapped, particularly if they are left unsupervised. There is a risk of injury.

Activate the override feature for the rear side windows. When leaving the vehicle, always take the SmartKey with you and lock the

vehicle. Never leave children unsupervised in the vehicle.

WARNING

If children are left unsupervised in the vehicle, they could:

- open the doors, thus endangering other people or road users.
- get out and disrupt traffic.
- operate the vehicle's equipment.

Additionally, children could set the vehicle in motion if, for example, they:

- release the parking brake.
- shifting the automatic transmission out of park position **P**
- Start the engine.

There is a risk of an accident and injury.

When leaving the vehicle, always take the SmartKey with you and lock the vehicle. Never leave children or animals unattended in the vehicle. Always keep the SmartKey out of reach of children.

Side window reversing feature

The side windows are equipped with an automatic reversing feature. If a solid object blocks or restricts a side window during the closing process, the side window opens again automatically. However, the automatic reversing feature is only an aid and does not relieve you of the responsibility of paying attention when closing a side window.

WARNING

The reversing feature does not react:

- to soft, light and thin objects, e.g. small fingers
- over the last 1/6 in (4 mm) of the closing movement
- during resetting
- when closing the side window again manually immediately after automatic reversing

This means that the reversing feature cannot prevent someone being trapped in these situations. There is a risk of injury.

Make sure that no body parts are in close proximity during the closing procedure. If someone becomes trapped, press the switch to open the side window again.

Opening and closing the side windows

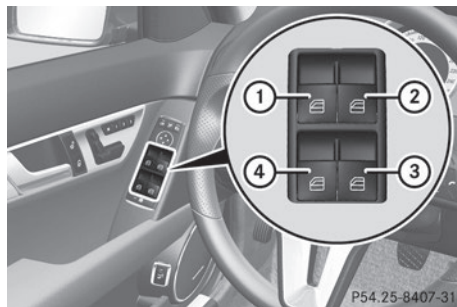

- ① Front left
- ② Front right
- ③ Rear right
- ④ Rear left

The switches for all side windows are located on the driver's door. There is also a switch on each door for the corresponding side window. The switches on the driver's door take precedence.

i The side windows cannot be operated from the rear when the override feature for the side windows is activated (▷ page 64).

► Turn the SmartKey to position **1** or **2** in the ignition lock.

► **To open:** press the corresponding switch.

► **To close:** pull the corresponding switch.

i If you press the switch beyond the point of resistance, an automatic opening/closing process is started in the corresponding direction. You can stop automatic operation by operating the switch again.

- i** You can continue to operate the side windows after you switch off the engine or remove the SmartKey. This function is available for up to five minutes or until the driver's or front-passenger door is opened.

Convenience opening



You can ventilate the vehicle before you start driving. To do this, the SmartKey is used to carry out the following functions simultaneously:

- unlock the vehicle
- open the side windows
- open the sliding sunroof or the panorama roof with power tilt/sliding panel and the roller sunblinds

- i** The convenience opening feature can only be operated using the SmartKey. The SmartKey must be close to the driver's door handle.

- ▶ Point the tip of the SmartKey at the driver's door handle.
- ▶ Press and hold the  button until the side windows and the sliding sunroof or the panorama roof with power tilt/sliding panel are in the desired position.

If the roller sunblinds of the panorama roof with power tilt/sliding panel are closed, the roller sunblinds are opened first.

- ▶ Press and hold the  button again until the panorama roof with power tilt/sliding panel is in the desired position.
- ▶ **To interrupt convenience opening:** release the  button.

Convenience closing feature

General notes

When you lock the vehicle, you can simultaneously:

- close the side windows
- close the sliding sunroof or the panorama roof with power tilt/sliding panel

On vehicles with a panorama roof with power tilt/sliding panel, you can then close the roller sunblinds.



WARNING

When the convenience closing feature is operating, parts of the body could become trapped in the closing area of the side window and the sliding sunroof. There is a risk of injury.

Observe the complete closing procedure when the convenience closing feature is operating. Make sure that no body parts are in close proximity during the closing procedure.

Proceed as follows if someone is trapped:

With the SmartKey:

- release the  button.
- press and hold the  button until the side windows and the sliding sunroof or the panorama roof with power tilt/sliding panel open again.

Using KEYLESS-GO:

- release the sensor surface on the door handle.
- pull the door handle immediately and hold it.



The side windows and the sliding sunroof or the panorama roof with power tilt/sliding panel open.

Using the SmartKey

- i** The SmartKey must be close to the driver's door handle.

- ▶ Point the tip of the SmartKey at the driver's door handle.
- ▶ Press and hold the  button until the side windows and the sliding sunroof or the panorama roof with power tilt/sliding panel are fully closed.
- ▶ Make sure that all the side windows and the sliding sunroof or panorama roof with power tilt/sliding panel are closed.

On vehicles with a panorama roof with power tilt/sliding panel:

- ▶ Press and hold the  button again until the roller sunblinds of the panorama roof with power tilt/sliding panel close.
- ▶ **To interrupt convenience closing:** release the  button.

Using KEYLESS-GO

The KEYLESS-GO key must be outside the vehicle. All the doors must be closed.

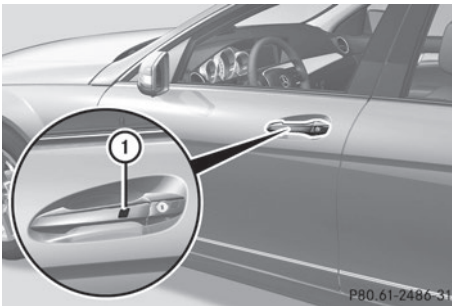

- ▶ Touch recessed sensor surface ① on the door handle until the side windows and the sliding sunroof or the panorama roof with power tilt/sliding panel are fully closed.
- ▶ **i** Make sure you only touch recessed sensor surface ①.
- ▶ Make sure that all the side windows and the sliding sunroof or panorama roof with power tilt/sliding panel are closed.

On vehicles with a panorama roof with power tilt/sliding panel:

- ▶ Touch recessed sensor surface ① on the door handle again until the roller sunblinds of the panorama roof with power tilt/sliding panel close.
- ▶ **To interrupt convenience closing:** release recessed sensor surface ① on the door handle.

Resetting the side windows

You must reset each side window if a side window can no longer be closed fully.

- ▶ Close all the doors.
- ▶ Turn the SmartKey to position **1** or **2** in the ignition lock.
- ▶ Pull the corresponding switch on the door control panel until the side window is completely closed (▷ page 88).
- ▶ Hold the switch for an additional second.

If the side window opens again slightly:

- ▶ Immediately pull the corresponding switch on the door control panel until the side window is completely closed (▷ page 88).
- ▶ Hold the switch for an additional second.
- ▶ If the corresponding side window remains closed after the button has been released, the side window has been reset correctly. If this is not the case, repeat the steps above again.

Problems with the side windows

Problem: a side window cannot be closed because it is blocked by objects, e.g. leaves in the window guide.

- ▶ Remove the objects.
- ▶ Close the side window.

Problem: a side window cannot be closed and you cannot see the cause.

⚠ WARNING

If you close a side window again immediately after it has been blocked or reset, the side window closes with increased or maximum force. The reversing feature is then not active. Parts of the body could be trapped in the closing area in the process. This poses an increased risk of injury or even fatal injury. Make sure that no parts of the body are in the closing area. To stop the closing process, release the switch or push the switch again to reopen the side window.

If a side window is obstructed during closing and reopens again slightly:

- ▶ Immediately after the window blocks, pull the corresponding switch again until the side window has closed. The side window is closed with increased force.

If a side window is obstructed again during closing and reopens again slightly:

- ▶ Immediately after the window blocks, pull the corresponding switch again until the side window has closed. The side window is closed without the anti-entrapment feature.

Sliding sunroof**Important safety notes**

Your vehicle may be equipped with a sliding sunroof or a panorama roof with power tilt/sliding panel. In this section, the term "sliding sunroof" refers to both types of sliding sunroof.

⚠ WARNING

While opening and closing the sliding sunroof, body parts in close proximity could become trapped. There is a risk of injury.

Make sure that no body parts are in close proximity during the opening and closing procedures.

If somebody becomes trapped:

- release the switch immediately, or
- during automatic operation, push the switch briefly in any direction

The opening or closing procedure will be stopped.

⚠ WARNING

If children operate the sliding sunroof they could become trapped, particularly if they are left unsupervised. There is a risk of injury. When leaving the vehicle, always take the SmartKey with you and lock the vehicle. Never leave children unsupervised in the vehicle.

- ❗ Only open the sliding sunroof if it is free of snow and ice. Otherwise, malfunctions may occur.

Do not allow anything to protrude from the sliding sunroof. Otherwise, the seals could be damaged.

- ❗ The weather can change abruptly. It could start to rain or snow. Make sure that the sliding sunroof is closed when you leave the vehicle. The vehicle electronics can be damaged if water enters the vehicle interior.

- i Resonance noises can occur in addition to the usual airflow noises when the sliding sunroof is open. They are caused by minor pressure fluctuations in the vehicle interior. Change the position of the sliding sunroof or open a side window slightly to reduce or eliminate these noises.

Sliding sunroof reversing feature

Your vehicle may be equipped with a sliding sunroof or a panorama roof with power tilt/sliding panel. In this section, the term "sliding sunroof" refers to both types of sliding sunroof.

The sliding sunroof is equipped with an automatic reversing feature. If a solid object blocks or restricts the sliding sunroof during

the closing process, the sliding sunroof opens again automatically. However, the automatic reversing feature is only an aid and does not relieve you of the responsibility of paying attention when closing the sliding sunroof.

WARNING

The reversing feature does not react:

- to soft, light and thin objects, e.g. small fingers
- over the last 1/6 in (4 mm) of the closing movement
- during resetting
- when closing the sliding sunroof again manually immediately after automatic reversing

This means that the reversing feature cannot prevent someone being trapped in these situations. There is a risk of injury.

Make sure that no body parts are in close proximity during the closing procedure.

If somebody becomes trapped:

- release the switch immediately, or
- during automatic operation, push the switch briefly in any direction

The closing process is stopped.

Operating the sliding sunroof

Opening and closing

- i** You can continue to operate the sliding sunroof after switching off the engine or removing the SmartKey from the ignition lock. This function remains active for five minutes or until you open a front door.

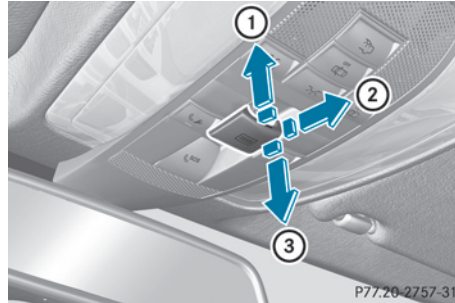

Overhead control panel

- ① To raise
- ② To open
- ③ To close/lower

- ▶ Turn the SmartKey to position **1** or **2** in the ignition lock.
- ▶ Press or pull the  switch in the corresponding direction.

- i** If you press the  switch beyond the point of resistance, an automatic opening/closing process is started in the corresponding direction. You can stop automatic operation by operating the switch again.

The automatic opening and raising feature is available only when the sliding sunroof is closed.

The sun protection cover automatically opens along with the sliding sunroof. You can open or close the sun protection cover manually when the sliding sunroof is raised or closed.

Resetting

Reset the sliding sunroof if it does not move smoothly.

- ▶ Turn the SmartKey to position **2** in the ignition lock.
- ▶ Raise the sliding sunroof fully at the rear (▷ page 92).
- ▶ Keep the  switch pressed for another second.

- ▶ Make sure that the sliding sunroof can be fully opened and closed again (▷ page 92).
- ▶ If this is not the case, repeat the steps above again.

! If the sliding sunroof still cannot be opened or closed fully after resetting, contact a qualified specialist workshop.

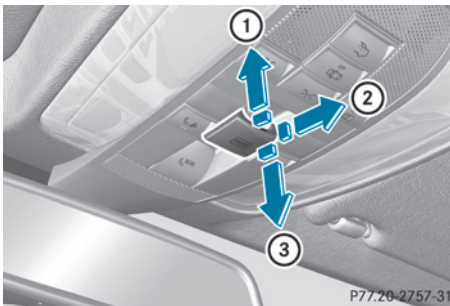

Operating the panorama roof with power tilt/sliding panel



Overhead control panel

- ① To raise
- ② To open
- ③ To close/lower

The panorama roof with power tilt/sliding panel can only be operated when the roller sunblind is open.

- ▶ Turn the SmartKey to position **1** or **2** in the ignition lock.
- ▶ Press or pull the  switch in the corresponding direction.
- i** If you press the  switch beyond the point of resistance, an automatic opening/closing process is started in the corresponding direction. You can stop automatic operation by operating the switch again.

The automatic raising feature is available only when the panorama roof with power tilt/sliding panel is closed.

Operating the roller sunblinds for the panorama roof with power tilt/sliding panel

General notes

The roller sunblinds shield the vehicle interior from sunlight. The two roller sunblinds can only be opened and closed together when the panorama roof with power tilt/sliding panel is closed.

WARNING

When opening or closing the roller sunblind, parts of the body could be trapped between the roller sunblind and the frame or sliding sunroof. There is a risk of injury.

When opening or closing make sure that no parts of the body are in the sweep of the roller sunblind.

If somebody becomes trapped:

- release the switch immediately, or
- during automatic operation, push the switch briefly in any direction

The opening or closing procedure will be stopped.

Roller sunblind reversing feature

The roller sunblinds are equipped with an automatic reversing feature. If an object blocks or restricts the roller sunblind during the closing process, the roller sunblind opens again automatically. However, the automatic reversing feature is only an aid and does not relieve you of the responsibility of paying attention when closing the roller sunblinds.

WARNING

The reversing feature does not react:

- to soft, light and thin objects, e.g. small fingers
- when closing the roller sunblind again manually immediately after automatic reversing

This means that the reversing feature cannot prevent someone being trapped in these situations. There is a risk of injury.

When closing make sure that no parts of the body are in the sweep of the roller sunblind.

If somebody becomes trapped:

- release the switch immediately, or
- during automatic operation, push the switch briefly in any direction

The closing process is stopped.

Opening and closing

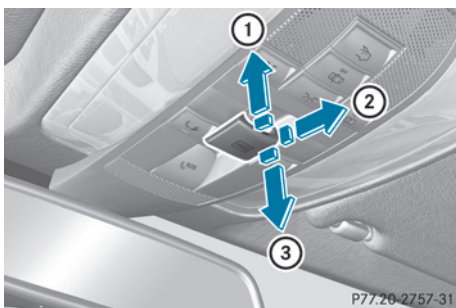

Overhead control panel







- ① To open
- ② To open
- ③ To close

- ▶ Turn the SmartKey to position **1** or **2** in the ignition lock.
- ▶ Press or pull the  switch in the corresponding direction.

i If you press the  switch beyond the point of resistance, an automatic opening/closing process is started in the corresponding direction. You can stop automatic operation by operating the switch again.

Resetting the sliding sunroof and the roller sunblinds

Reset the panorama roof with power tilt/sliding panel and the roller sunblinds if the panorama roof with power tilt/sliding panel or the roller sunblinds do not move smoothly.

- ▶ Turn the SmartKey to position **1** or **2** in the ignition lock.
- ▶ Press the  button to the point of resistance in the direction of arrow ② until the panorama roof with power tilt/sliding panel is open approximately 4 in (10 cm).
- ▶ Pull the  switch repeatedly to the point of resistance in the direction of arrow ③ until the panorama roof with power tilt/sliding panel is fully closed.
- ▶ Keep the  switch pulled for an additional second.
- ▶ Press the  button to the point of resistance in the direction of arrow ② until the roller sunblinds are open approximately 4 in (10 cm).
- ▶ Pull the  switch repeatedly to the point of resistance in the direction of arrow ③ until the roller sunblinds are fully closed.
- ▶ Keep the  switch pulled for an additional second.
- ▶ Make sure that the panorama roof with power tilt/sliding panel and the roller sunblinds can be fully opened and closed again (▷ page 93).
- ▶ If this is not the case, repeat the steps above again.

! If the panorama roof with power tilt/sliding panel and the roller sunblinds cannot be fully opened or closed after resetting, contact a qualified specialist workshop.

Problems with the sliding sunroof

Your vehicle may be equipped with a sliding sunroof or a panorama roof with power tilt/sliding panel. In this section, the term "sliding sunroof" refers to both types of sliding sunroof.

Problem: the sunroof cannot be closed and you cannot see the cause.

 **WARNING**

If you close the sliding sunroof again immediately after it has been blocked or reset, the sliding sunroof closes with increased or maximum force. The reversing feature is then not active. Parts of the body could be trapped in the closing area in the process. This poses an increased risk of injury or even fatal injury.

Make sure that no parts of the body are in the closing area.

If somebody becomes trapped:

- release the switch immediately, or
- during automatic operation, push the switch briefly in any direction

The closing process is stopped.

If the sliding sunroof is obstructed during closing and reopens again slightly:

- ▶ Immediately after the sliding sunroof blocks, pull the  switch in the overhead control panel down to the point of resistance and hold it until the sliding sunroof is closed.
The sliding sunroof is closed with increased force.

If the sliding sunroof is obstructed again during closing and then reopens slightly:

- ▶ Immediately after the sliding sunroof blocks, pull the  switch in the overhead control panel down to the point of resistance and hold it until the sliding sunroof is closed.
The sliding sunroof is closed without the anti-entrapment feature.

- ❗ If the sliding sunroof still cannot be opened or closed as a result of a malfunction, contact a qualified specialist workshop.

Useful information	98
Correct driver's seat position	98
Seats	99
Steering wheel	105
Mirrors	107
Memory function	110

Useful information

- i** This Operator's Manual describes all models and all standard and optional equipment of your vehicle available at the time of publication of the Operator's Manual. Country-specific differences are possible. Please note that your vehicle may not be equipped with all features described. This also applies to safety-related systems and functions.
- i** Read the information on qualified specialist workshops: (▷ page 25).

Correct driver's seat position



- ▶ Observe the safety guidelines on seat adjustment (▷ page 99).
 - ▶ Make sure that seat ③ is adjusted properly.
Manual and electrical seat adjustment (▷ page 100)
Electrical seat adjustment (▷ page 100)
- When adjusting the seat, make sure that:
- you are as far away from the driver's air bag as possible.
 - you are sitting in a normal upright position.
 - you can fasten the seat belt properly.

- you have moved the backrest to an almost vertical position.
 - you have set the seat cushion angle so that your thighs are gently supported.
 - you can depress the pedals properly.
- ▶ Check whether the head restraint is adjusted properly.

When doing so, make sure that you have adjusted the head restraint so that the back of your head is supported at eye level by the center of the head restraint.

- ▶ Observe the safety guidelines on steering wheel adjustment (▷ page 105).
- ▶ Make sure that steering wheel ① is adjusted properly.

Adjusting the steering wheel manually (▷ page 106)

Adjusting the steering wheel electrically (▷ page 106)

When adjusting the steering wheel, make sure that:

- you can hold the steering wheel with your arms slightly bent.
 - you can move your legs freely.
 - you can see all the displays in the instrument cluster clearly.
- ▶ Observe the safety guidelines for seat belts (▷ page 54).
- ▶ Check whether you have fastened seat belt ② properly (▷ page 56).

The seat belt should:

- fit snugly across your body
 - be routed across the middle of your shoulder
 - be routed in your pelvic area across the hip joints
- ▶ Before starting off, adjust the rear-view mirror and the exterior mirrors in such a way that you have a good view of road and traffic conditions (▷ page 107).
- ▶ **Vehicles with a memory function:** save the seat, steering wheel and exterior mirror

settings with the memory function
(▷ page 110).

Seats

Important safety notes

WARNING

Children could become trapped if they adjust the seats, particularly when unattended. There is a risk of injury.

When leaving the vehicle, always take the SmartKey with you and lock the vehicle. Never leave children unsupervised in the vehicle.

WARNING

You could lose control of your vehicle if you do the following while driving:

- adjust the driver's seat, head restraint, steering wheel or mirrors
- fasten the seat belt

There is a risk of an accident.

Adjust the driver's seat, head restraint, steering wheel and mirror and fasten your seat belt before starting the engine.

WARNING

If you adjust the seat height carelessly, you or other vehicle occupants could be trapped and thereby injured. Children in particular could accidentally press the electrical seat adjustment buttons and become trapped. There is a risk of injury.

While moving the seats, make sure that your hands or other body parts do not get under the lever assembly of the seat adjustment system.

WARNING

When you adjust a seat, you or other vehicle occupants could become trapped, e.g. on the seat guide rail. There is a risk of injury.

Make sure when adjusting a seat that no one has any body parts in the sweep of the seat.

WARNING

If head restraints are not installed and adjusted correctly, they cannot provide protection as intended. There is an increased risk of injury in the head and neck area, e.g. in the event of an accident or when braking.

Always drive with the head restraints installed. Before driving off, make sure for every vehicle occupant that the center of the head restraint supports the back of the head at about eye level.

WARNING

The seat belt does not offer the intended level of protection if the backrest is not in the upright position. When braking or in the event of an accident, you could slide underneath the seat belt and sustain abdomen or neck injuries, for example. This poses an increased risk of injury or even fatal injury.

Adjust the seat properly before beginning your journey. Always make sure that the seat is in the upright position.

WARNING

According to accident statistics, children are safer when properly restrained on the rear seats than on the front-passenger seat. Thus, we strongly recommend that children be placed in the rear seat whenever possible. Regardless of seating position, children 12 years old and under must be seated and properly secured in an appropriately sized child restraint system or booster seat recommended for the size and weight of the child. For additional information, see the "Children in the vehicle" section.

A child's risk of serious or fatal injuries is significantly increased if the child restraints are not properly secured in the vehicle and/or the child is not properly secured in the child restraint.

! To avoid damage to the seats and the seat heating, observe the following information:

- keep liquids from spilling on the seats. If liquid is spilled on the seats, dry them as soon as possible.
- if the seat covers are damp or wet, do not switch on the seat heating. The seat heating should also not be used to dry the seats.
- clean the seat covers as recommended; see the "Interior care" section.
- do not transport heavy loads on the seats. Do not place sharp objects on the seat cushions, e.g. knives, nails or tools. The seats should only be occupied by passengers, if possible.
- when the seat heating is in operation, do not cover the seats with insulating materials, e.g. blankets, coats, bags, seat covers, child seats or booster seats.

! Make sure that there are no objects in the footwell or behind the seats when resetting the seats. There is a risk that the seats and/or the objects could be damaged.

i The head restraints in the front seats are installed with the NECK-PRO system (▷ page 52). For this reason, it is not possible to remove the head restraints from the front seats.

Vehicles without the through-loading feature: the head restraints cannot be removed from the rear compartment seats.

For more information, contact a qualified specialist workshop.

i Further related subjects:

- Rear bench seat through-loading feature (▷ page 264)

Adjusting the seats manually and electrically

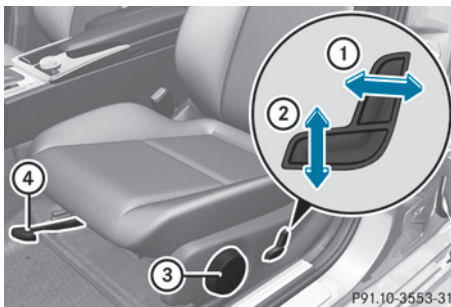

- ① Backrest angle
- ② Seat height
- ③ Seat cushion angle
- ④ Seat fore-and-aft adjustment

i AMG vehicles are equipped with a seat with an integrated head restraint. It is therefore not possible to set the height and angle of the head restraint.

i Adjust the seat cushion angle so that your thighs are lightly supported.

Seat fore-and-aft adjustment

- ▶ Lift handle ④ and slide the seat forwards or rearwards.
- ▶ Release lever ④ again.
Make sure that you hear the seat engage in position.

Seat cushion angle

- ▶ Turn handwheel ③ in the desired direction.

Adjusting the seats electrically

i Vehicles without Memory function: the seats can be adjusted within three minutes of a front door being opened.

The time period starts over again if, within these three minutes, you:

- open or close a front door
- insert the SmartKey into the ignition lock or remove it from the ignition lock
- switch the ignition on or off

If the SmartKey is in position **2** in the ignition lock, the seats can be adjusted at any time.

Depending on the equipment, the seat adjustment buttons are either located on the side of the seat or on the door control panel.

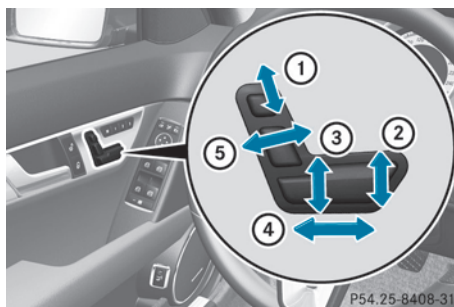

- ① Head restraint height
- ② Seat cushion angle
- ③ Seat height
- ④ Seat fore-and-aft adjustment
- ⑤ Backrest angle

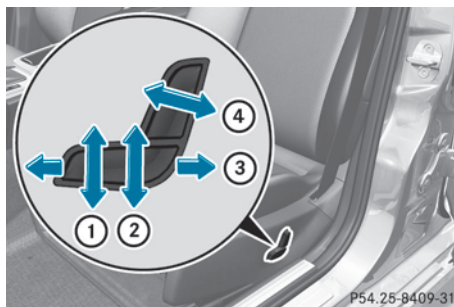

- ① Seat cushion angle
- ② Seat height
- ③ Seat fore-and-aft adjustment
- ④ Backrest angle

- ① You can store the seat settings using the memory function (▷ page 110).
- ① AMG vehicles are equipped with a seat with an integrated head restraint. It is therefore not possible to set the height and angle of the head restraint.

Adjusting the head restraints

⚠ WARNING

You could lose control of your vehicle if you do the following while driving:

- adjust the driver's seat, head restraint, steering wheel or mirrors
- fasten the seat belt

There is a risk of an accident.

Adjust the driver's seat, head restraint, steering wheel and mirror and fasten your seat belt before starting the engine.

⚠ WARNING

If head restraints are not installed and adjusted correctly, they cannot provide protection as intended. There is an increased risk of injury in the head and neck area, e.g. in the event of an accident or when braking. Always drive with the head restraints installed. Before driving off, make sure for every vehicle occupant that the center of the head restraint supports the back of the head at about eye level.

General notes

Pay attention to the important safety notes (▷ page 99).

Do not rotate the head restraints of the front and rear seats. Otherwise, you cannot adjust the height and angle of the head restraints to the correct position.

Adjusting the head restraints manually

Adjusting the head restraint height²

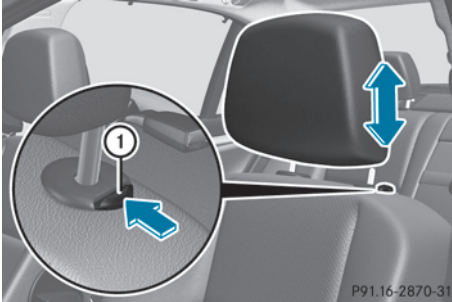

- ▶ **To raise:** pull the head restraint up to the desired position.
- ▶ **To lower:** press release catch ① in the direction of the arrow and push the head restraint down to the desired position.

Adjusting the angle of the head restraints



- ▶ Push or pull the lower edge of the head restraint in the direction of the arrow.

Adjusting the height of the head restraints electrically

- ▶ **To adjust the head restraint height:** slide the switch for head restraint adjustment (> page 100) up or down in the direction of the arrow.

Adjusting the luxury head restraints

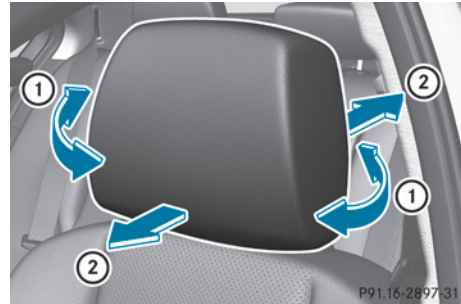

- ▶ **To adjust the side bolsters of the head restraint:** push or pull right and/or left-hand side bolster ① into the desired position.
- ▶ **To adjust the angle of the head restraint:** push or pull the head restraint in the direction of arrow ②.

i Adjust the head restraint so that the back of your head is as close to the head restraint as possible.

Rear seat head restraints

Adjusting the rear seat head restraint height

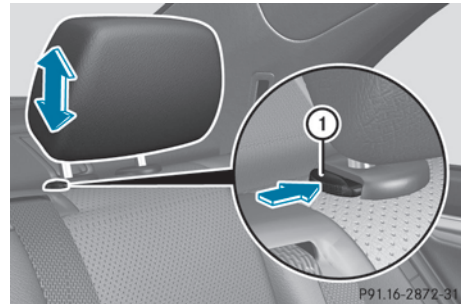

Once the head restraint is fully lowered, press release catch ①.

- ▶ **To raise:** pull the head restraint up to the desired position.

² For vehicles without memory function only.

- ▶ **To lower:** press release catch ① and push the head restraint down until it is in the desired position.

Installing/removing the rear seat head restraints³

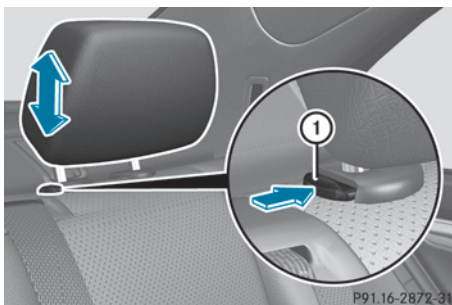

- ▶ Release the rear seat backrest and fold it slightly forwards (▷ page 265).
- ▶ **To remove:** pull the head restraint up to the stop.
- ▶ Press release catch ① and pull the head restraint out of the guides.
- ▶ **To re-install:** insert the head restraint so that the notches on the bar are on the left when viewed in the direction of travel.
- ▶ Push the head restraint down until you hear it engage in position.
- ▶ Fold back the rear seat backrest until it engages.

Adjusting the lumbar support

You can adjust the contour of the front seats so as to provide optimum support for your back.

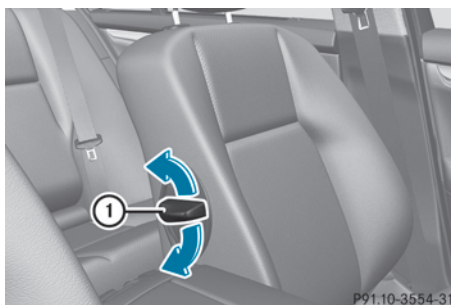

- ▶ Move adjustment lever ① in the direction of the arrow until the desired backrest contour is achieved.

Adjusting the 4-way lumbar support

You can adjust the contour of the front seat backrests individually to provide optimum support for your back.

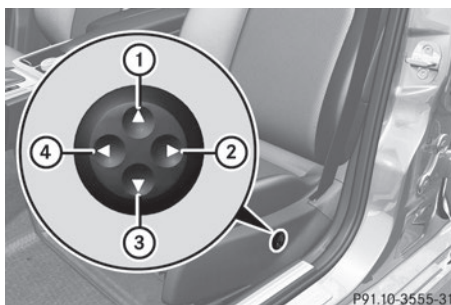

- ① To raise the backrest contour
- ② To soften the backrest contour
- ③ To lower the backrest contour
- ④ To harden the backrest contour

Adaptive seat backrests (AMG vehicles)

You can adjust the contour of the front seat backrests individually so as to provide optimum support for your back.

³ Only for vehicles with the through-loading feature.

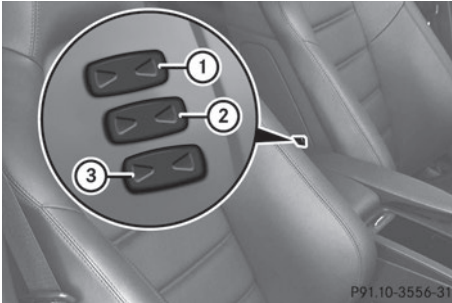

- ① To adjust the upper back support
 - ② To adjust the contour of the backrest in the lumbar region
 - ③ To adjust the lateral structure and support of the seat
- ▶ Make sure that the SmartKey is in position 2 in the ignition lock.
 - ❗ Repeat the adjustment if the seat no longer has the desired contour after a certain amount of time.

Switching the seat heating on/off

Activating/deactivating

WARNING

Repeatedly switching on the seat heating can cause the seat cushion and backrest pads to become very hot. The health of persons with limited temperature sensitivity or a limited ability to react to excessively high temperatures may be affected or they may even suffer burn-like injuries. There is a risk of injury.

Therefore, do not switch the seat heating on repeatedly.

The three red indicator lamps in the button indicate the heating level you have selected.

- ❗ If the battery voltage is too low, the seat heating may switch off.



Driver's and front-passenger seat

The system automatically switches down from level 3 to level 2 after approximately eight minutes.

The system automatically switches down from level 2 to level 1 after approximately ten minutes.

The system automatically switches off approximately 20 minutes after it is set to level 1.

- ▶ Make sure that the SmartKey is in position 1 or 2 in the ignition lock.
- ▶ **To switch on:** press button ① repeatedly until the desired heating level is set.
- ▶ **To switch off:** press button ① repeatedly until all the indicator lamps go out.

Problems with the seat heating

Problem	Possible causes/consequences and ► Solutions
The seat heating has switched off prematurely or cannot be switched on.	The on-board voltage is too low because too many electrical consumers are switched on. ► Switch off electrical consumers that you do not need, such as the rear window defroster or interior lighting.

Switching the seat ventilation on/off

Activating/deactivating

The three blue indicator lamps in the buttons indicate the ventilation level you have selected.

- ❗ If the battery voltage is too low, the seat ventilation may switch off.



- Make sure that the SmartKey is in position **2** in the ignition lock.
- **To switch on:** press button ① repeatedly until the desired ventilation level is set.
- ❗ You can open the side windows and the sliding sunroof using the "Convenience opening" feature (► page 89). The seat ventilation of the driver's seat automatically switches to the highest level.
- **To switch off:** press button ① repeatedly until all the indicator lamps go out.

Problems with the seat ventilation

The seat ventilation has switched off prematurely or cannot be switched on. The vehicle's electrical system voltage is too low because too many electrical consumers are switched on.

- Switch off electrical consumers that you do not need, such as the rear window defroster or interior lighting.

Steering wheel

Important safety notes

⚠ WARNING

You could lose control of your vehicle if you do the following while driving:

- adjust the driver's seat, head restraint, steering wheel or mirrors
- fasten the seat belt

There is a risk of an accident.

Adjust the driver's seat, head restraint, steering wheel and mirror and fasten your seat belt before starting the engine.

⚠ WARNING

Children could injure themselves if they adjust the steering wheel. There is a risk of injury.

When leaving the vehicle, always take the SmartKey with you and lock the vehicle. Never leave children unsupervised in the vehicle.

Adjusting the steering wheel manually

WARNING

If the steering wheel is unlocked while the vehicle is in motion, it could change position unexpectedly. This could cause you to lose control of the vehicle. There is a risk of an accident.

Before starting off, make sure the steering wheel is locked. Never unlock the steering wheel while the vehicle is in motion.

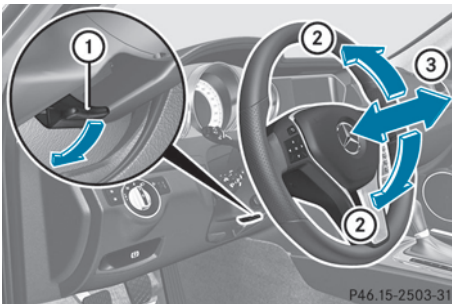

- ① Release lever
- ② To adjust the steering wheel height
- ③ To adjust the steering wheel position (fore-and-aft adjustment)

- ▶ Push release lever ① down completely. The steering column is unlocked.
- ▶ Adjust the steering wheel to the desired position.
- ▶ Push release lever ① up completely. The steering column is locked.
- ▶ Check if the steering column is locked. When doing so, try to push the steering wheel up or down or try to move it in the fore-and-aft direction.

Adjusting the steering wheel electrically

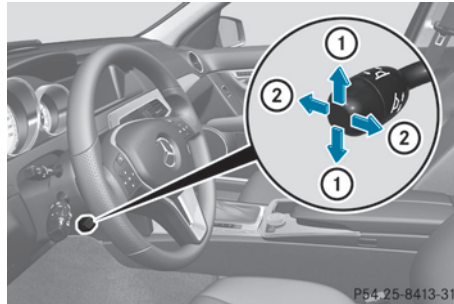

- ① To adjust the steering wheel height
- ② To adjust the steering wheel position (fore-and-aft adjustment)

The steering wheel can also be adjusted when the SmartKey is removed from the ignition lock.

- i** Further related subjects:
 - EASY-ENTRY/EXIT feature (> page 106)
 - Storing settings (> page 110)

EASY-ENTRY/EXIT feature

Important safety notes

WARNING

When the EASY-ENTRY/EXIT feature adjusts the steering wheel, you and other vehicle occupants – particularly children – could become trapped. There is a risk of injury. While the EASY-ENTRY/EXIT feature is making adjustments, make sure that no one has any body parts in the sweep of the steering wheel.

If somebody becomes trapped:

- press one of the memory function position buttons, or
- move the switch for steering wheel adjustment in the opposite direction to that in which the steering wheel is moving.

The adjustment process is stopped.

⚠ WARNING

If you drive off while the EASY-ENTRY/EXIT feature is making adjustments, you could lose control of the vehicle. There is a risk of an accident.

Always wait until the adjustment process is complete before driving off.

The EASY-ENTRY/EXIT feature makes getting in and out of your vehicle easier.

You can activate and deactivate the EASY-ENTRY/EXIT feature in the on-board computer (▷ page 218).

Position of the steering wheel when the EASY-ENTRY/EXIT feature is active

The steering wheel swings upwards when you:

- remove the SmartKey from the ignition lock
- open the driver's door with KEYLESS-GO in position **1**
- open the driver's door and the SmartKey is in position **0** or **1** in the ignition lock

i The steering wheel only moves upwards if it has not already reached the upper end stop.

Position of the steering wheel for driving

The steering wheel is moved to the last selected position when:

- the driver's door is closed
- you insert the SmartKey into the ignition lock
- or
- you press the Start/Stop button once on vehicles with KEYLESS-GO

When you close the driver's door with the ignition switched on, the steering wheel is also automatically moved to the previously set position.

The last position of the steering wheel is stored when you switch off the ignition or

when you store the setting with the memory function (▷ page 110).

Crash-responsive EASY-EXIT feature

If the crash-responsive EASY-EXIT feature is triggered in an accident, the steering column will move upwards when the driver's door is opened. This occurs irrespective of the position of the SmartKey in the ignition lock. This makes it easier to exit the vehicle and rescue the occupants.

The crash-responsive EASY-EXIT feature is only operational if the EASY-EXIT/ENTRY feature is activated in the on-board computer.

Mirrors**Rear-view mirror**

► **Anti-glare mode:** flick anti-glare lever **1** forwards or back.

Exterior mirrors**Adjusting the exterior mirrors****⚠ WARNING**

The exterior mirror on the front-passenger side reduces the size of the image. Visible objects are actually closer than they appear. This means that you could misjudge the distance from road users traveling behind, e.g. when changing lane. There is a risk of an accident.

For this reason, always make sure of the actual distance from the road users traveling behind by glancing over your shoulder.

The convex exterior mirrors provide a larger field of vision.

The exterior mirrors are automatically heated after starting the vehicle if the rear window defroster is switched on and the outside temperature is low. Mirror heating lasts up to 10 minutes.

- i** You can also heat up the exterior mirrors manually by switching on the rear window defroster.

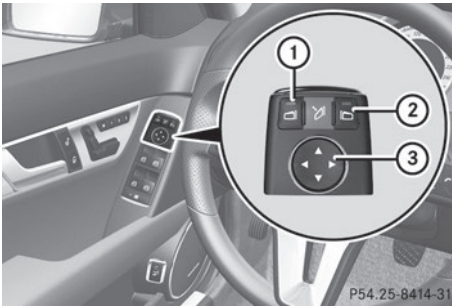

- ▶ Make sure that the SmartKey is in position **1** or **2** in the ignition lock.
- ▶ Press button **1** for the left-hand exterior mirror or button **2** for the right-hand exterior mirror. The indicator lamp in the corresponding button lights up in red. The indicator lamp goes out again after some time. You can adjust the selected mirror using adjustment button **3** as long as the indicator lamp is lit.
- ▶ Press adjustment button **3** up, down, or to the left or right until you have adjusted the exterior mirror to the correct position. You should have a good overview of traffic conditions.

Folding the exterior mirrors in or out electrically

This function is only available in vehicles for Canada.

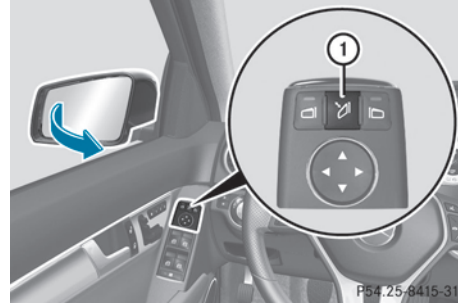

- ▶ Make sure that the SmartKey is in position **1** or **2** in the ignition lock.
- ▶ Briefly press button **1**. Both exterior mirrors fold in or out.
- i** Make sure that the exterior mirrors are always folded out fully while driving. They could otherwise vibrate.
- i** If you are driving faster than 9 mph (15 km/h), you can no longer fold in the exterior mirrors.

Setting the exterior mirrors

This function is only available in vehicles for Canada.

If the battery has been disconnected or completely discharged, the exterior mirrors must be reset. The exterior mirrors will otherwise not fold in when you select the "Fold in mirrors when locking" function in the on-board computer (▷ page 218).

- ▶ Make sure that the SmartKey is in position **1** in the ignition lock.
- ▶ Briefly press button **1**.

Folding the exterior mirrors in or out automatically

This function is only available in vehicles for Canada.

If the "Fold in mirrors when locking" function is activated in the on-board computer (▷ page 218):

- the exterior mirrors fold in automatically as soon as you lock the vehicle from the outside.
- the exterior mirrors fold out again automatically as soon as you unlock the vehicle and then open the driver's or front-passenger door.

i If the exterior mirrors have been folded in manually, they do not fold out.

Exterior mirror pushed out of position

If an exterior mirror has been pushed out of position, proceed as follows:

- ▶ **Vehicles without electrically folding exterior mirrors:** move the exterior mirror into the correct position manually.
- ▶ **Vehicles with electrically folding exterior mirrors⁴:** press and hold mirror-folding button until you hear a click followed by an impact sound. (▷ page 108)
The mirror housing is engaged again and you can adjust the exterior mirrors as usual (▷ page 107).

Automatic anti-glare mirrors

The rear-view mirror and the exterior mirror on the driver's side automatically go into anti-glare mode if the following conditions are met simultaneously:

- the ignition is switched on and
- incident light from headlamps strikes the sensor in the rear-view mirror.

The mirrors do not go into anti-glare mode if reverse gear is engaged or if the interior lighting is switched on.

Parking position for the exterior mirror on the front-passenger side

Setting and storing the parking position

Using reverse gear

You can position the front-passenger side exterior mirror in such a way that you can see the rear wheel on that side as soon as you engage reverse gear. You can store this position.

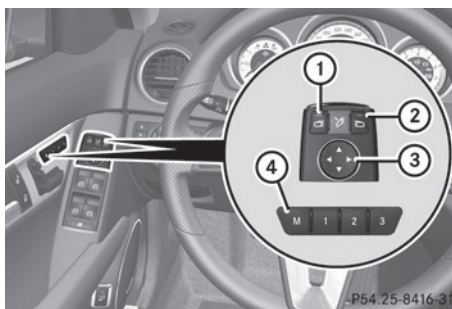

- ▶ Make sure that the vehicle is stationary and that the SmartKey is in position **2** in the ignition lock.
- ▶ Press button **2** for the exterior mirror on the front-passenger side.
- ▶ Engage reverse gear.
The exterior mirror on the front-passenger side moves to the preset parking position.
- ▶ Use adjustment button **3** to adjust the exterior mirror to a position that allows you to see the rear wheel and the curb.
The parking position is stored.
- i** If you shift the transmission to another position, the exterior mirror on the front-passenger side returns to the driving position.

Using the memory button

You can position the front-passenger side exterior mirror in such a way that you can see the rear wheel on that side as soon as you engage reverse gear. This setting can be stored using memory button **M** **4**.

⁴ Only for Canada.

- ▶ Make sure that the SmartKey is in position **2** in the ignition lock.
- ▶ With the exterior mirror on the front-passenger side activated, use adjustment button **③** to adjust the exterior mirror. In the exterior mirror, the rear wheel and the curb should be visible.
- ▶ Press memory button **M** **④** and one of the arrows on adjustment button **③** within three seconds.
The parking position is stored if the exterior mirror does not move.
- ▶ If the mirror moves out of position, repeat the steps.

Calling up a stored parking position setting

- ▶ Turn the SmartKey to position **2** in the ignition lock.
- ▶ Adjust the exterior mirror on the front-passenger side using button **②**.
- ▶ Engage reverse gear.
The exterior mirror on the front-passenger side moves to the stored parking position.

The exterior mirror on the front-passenger side moves back to its original position:

- as soon as you exceed a speed of 9 mph (15 km/h)
- if you press button **①** for the exterior mirror on the driver's side

Memory function

Storing settings

WARNING

If you use the memory function on the driver's side while driving, you could lose control of the vehicle as a result of the adjustments being made. There is a risk of an accident.

Only use the memory function on the driver's side when the vehicle is stationary.

WARNING

When the memory function adjusts the seat or steering wheel, you and other vehicle occupants – particularly children – could become trapped. There is a risk of injury.

While the memory function is making adjustments, make sure that no one has any body parts in the sweep of the seat or steering wheel. If somebody becomes trapped, immediately release the memory function position button. The adjustment process is stopped.

WARNING

Children could become trapped if they activate the memory function, particularly when unattended. There is a risk of injury.

When leaving the vehicle, always take the SmartKey with you and lock the vehicle. Never leave children unsupervised in the vehicle.

With the memory function, you can store up to three different settings, e.g. for three different people.

The following settings are stored as a single memory preset:

- position of the seat, backrest and head restraint
- driver's side: steering wheel position
- driver's side: position of the exterior mirrors on the driver's and front-passenger sides



P54.25-8417-31

- ▶ Adjust the seat (▷ page 100).
- ▶ On the driver's side, adjust the steering wheel (▷ page 106) and the exterior mirrors (▷ page 107).
- ▶ Briefly press the **M** memory button and then press storage position button **1**, **2** or **3** within three seconds.
The settings are stored in the selected preset position. A tone sounds when the settings have been completed.

Calling up a stored setting

- ❗ If you want to move the seat from the fully reclined position to a stored seat position, first raise the backrest. The seat could otherwise be damaged.
- ▶ Press and hold the relevant storage position button **1**, **2** or **3** until the seat, steering wheel and exterior mirrors are in the stored position.
- i The setting procedure is interrupted as soon as you release the storage position button.

Useful information	114
Exterior lighting	114
Interior lighting	120
Replacing bulbs	121
Windshield wipers	125

Useful information

- i** This Operator's Manual describes all models and all standard and optional equipment of your vehicle available at the time of publication of the Operator's Manual. Country-specific differences are possible. Please note that your vehicle may not be equipped with all features described. This also applies to safety-related systems and functions.
- i** Read the information on qualified specialist workshops: (▷ page 25).

Exterior lighting

General notes

For reasons of safety, Mercedes-Benz recommends that you drive with the lights switched on even during the daytime. In some countries, operation of the headlamps varies due to legal requirements and self-imposed obligations.

Notes on driving abroad

Conversion to symmetrical low beam

Switch the headlamps to symmetrical low beam in countries in which traffic drives on the opposite side of the road from the country where the vehicle is registered. This prevents glare to oncoming traffic. When using symmetrical lights, the edge of the road is not lit as widely and as far ahead as normal.

Have the headlamps converted at a qualified specialist workshop as close to the border as possible before driving in these countries.

Conversion to asymmetrical low beam after returning

Have the headlamps converted back to asymmetrical low-beam headlamps at a qualified specialist workshop as soon as possible after crossing the border again.

Setting the exterior lighting

Setting options

Exterior lighting can be set using:

- the light switch
- the combination switch (▷ page 116)
- the on-board computer (▷ page 216)

Light switch

Operation

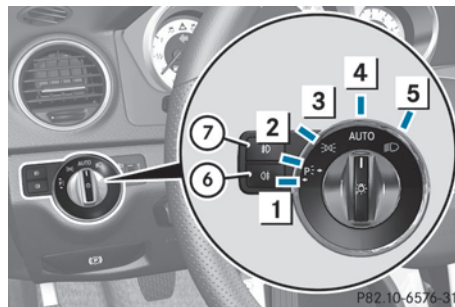

- 1** Left-hand standing lamps
- 2** Right-hand standing lamps
- 3** Parking lamps, license plate and instrument cluster lighting
- 4** **AUTO** Automatic headlamp mode, controlled by the light sensor
- 5** Low-beam/high-beam headlamps
- 6** Rear fog lamp
- 7** Fog lamp (only vehicles with front fog lamps)

If you hear a warning tone when you leave the vehicle, the lights may still be switched on.

- ▶ Turn the light switch to **AUTO**.

The exterior lighting (except the parking/standing lamps) switches off automatically if you:

- remove the SmartKey from the ignition lock
- open the driver's door with the SmartKey in position **0**.

Automatic headlamp mode

WARNING

When the light switch is set to , the low-beam headlamps may not be switched on automatically if there is fog, snow or other causes of poor visibility due to the weather conditions such as spray. There is a risk of an accident.

In such situations, turn the light switch to .

The automatic headlamp feature is only an aid. The driver is responsible for the vehicle's lighting at all times.

 is the favored light switch setting. The light setting is automatically selected according to the brightness of the ambient light (exception: poor visibility due to weather conditions such as fog, snow or spray):

- SmartKey in position **1** in the ignition lock: the parking lamps are switched on or off automatically depending on the brightness of the ambient light.
- With the engine running: if you have activated the daytime running lamps function via the on-board computer, the daytime running lamps or the low-beam headlamps and parking lamps are switched on or off automatically depending on the brightness of the ambient light.



► **To switch on automatic headlamp mode:** turn the light switch to .

Only for Canada:

The daytime running lamps improve the visibility of your vehicle during the day. The daytime running lamps function is required by law in Canada. It cannot therefore be deactivated.



When the engine is running and the vehicle is stationary: if you move the selector lever from a drive position to **P**, the daytime running lamps/low-beam headlamps go out after three minutes.

When the engine is running, the vehicle is stationary and in bright ambient light: if you

turn the light switch to , the daytime running lamps and parking lamps switch on. If the engine is running and you turn the light switch to , the manual settings take precedence over the daytime running lamps.

USA only:

The daytime running lamps improve the visibility of your vehicle during the day. To do this, the daytime running lamps function must be switched on using the on-board computer (► page 216).

If the engine is running and you turn the light switch to  or , the manual settings take precedence over the daytime running lamps.



Low-beam headlamps

WARNING

When the light switch is set to , the low-beam headlamps may not be switched on automatically if there is fog, snow or other causes of poor visibility due to the weather conditions such as spray. There is a risk of an accident.

In such situations, turn the light switch to .





Even if the light sensor does not detect that it is dark, the parking lamps and low-beam headlamps switch on when the ignition is switched on and the light switch is set to the  position. This is a particularly useful function in the event of rain and fog.

- **To switch on the low-beam headlamps:** turn the SmartKey in the ignition lock to position **2** or start the engine.
- Turn the light switch to . The green  indicator lamp in the instrument cluster lights up.

Front fog lamps

In conditions where visibility is poor due to fog, snow or rain, the fog lamps improve visibility as well as making it easier for other road users to see you. They can be operated together with the parking lamps or together





with the parking lamps and low-beam headlamps.

- ▶ **To switch on the front fog lamps:** turn the SmartKey in the ignition lock to position **2** or start the engine.
- ▶ Turn the light switch to  or **AUTO**.
- ▶ Press the  button.
The green  indicator lamp in the instrument cluster lights up.
- ▶ **To switch off the front fog lamps:** press the  button.
The green  indicator lamp in the instrument cluster goes out.



Only vehicles with front fog lamps have the fog lamps function.

Rear fog lamp

The rear fog lamp improves visibility of your vehicle for the traffic behind in the event of thick fog. Please take note of the country-specific regulations for the use of rear fog lamps.

- ▶ **To switch on the rear fog lamps:** turn the SmartKey in the ignition lock to position **2** or start the engine.
- ▶ Turn the light switch to  or **AUTO**.
- ▶ Press the  button.
The yellow  indicator lamp in the instrument cluster lights up.
- ▶ **To switch off the rear fog lamp:** press the  button.
The yellow  indicator lamp in the instrument cluster goes out.

Parking lamps



- ❗ If the battery has been excessively discharged, the parking lamps or standing lamps are automatically switched off to enable the next engine start. Always park your vehicle safely and sufficiently lit according to legal standards. Avoid the continuous use of the  parking lamps for several hours. If possible, switch on the  right or the  left standing lamp.

- ▶ **To switch on:** turn the light switch to .

The green indicator lamp in the instrument cluster lights up.

Standing lamps

Switching on the standing lamps ensures the corresponding side of the vehicle is illuminated.

- ▶ **To switch on the standing lamps:** the SmartKey is not in the ignition lock or it is in position **0**.
- ▶ Turn the light switch to  (left-hand side of the vehicle) or  (right-hand side of the vehicle).

Combination switch

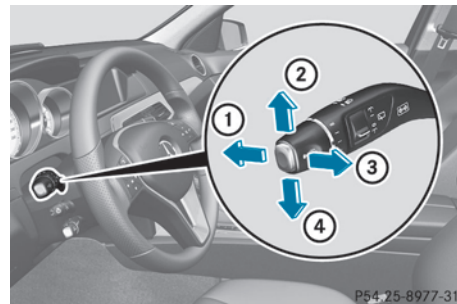

Turn signal



- ① High-beam headlamps
- ② Turn signal, right
- ③ High-beam flasher
- ④ Turn signal, left

- ▶ **To indicate briefly:** press the combination switch briefly to the pressure point in the direction of arrow ② or ④.
The corresponding turn signal flashes three times.
- ▶ **To indicate:** press the combination switch beyond the pressure point in the direction of arrow ② or ④.

High-beam headlamps

- ▶ **To switch on the high-beam headlamps:** turn the SmartKey in the ignition lock to position **2** or start the engine.
- ▶ Turn the light switch to  or **AUTO**.
- ▶ Press the combination switch beyond the pressure point in the direction of arrow ①.
In the **AUTO** position, the high-beam headlamps are only switched on when it is dark and the engine is running.
The  indicator lamp in the instrument cluster lights up when the high-beam headlamps are switched on.
- ▶ **To switch off the high-beam headlamps:** move the combination switch back to its normal position.
The  indicator lamp in the instrument cluster goes out.

High-beam flasher

- ▶ **To switch on:** turn the SmartKey in the ignition lock to position **1** or **2** or start the engine.
- ▶ Pull the combination switch in the direction of arrow ③.

Hazard warning lamps



The hazard warning lamps automatically switch on if:

- an air bag is deployed.
- the vehicle is slowed down rapidly from a speed of over 45 mph (70 km/h) and comes to a halt.

- ▶ **To switch on the hazard warning lamps:** press button ①.

All turn signals flash. If you now switch on a turn signal using the combination switch, only the turn signal lamp on the corresponding side of the vehicle will flash.

- ▶ **To switch off the hazard warning lamps:** press button ①.

If the vehicle returns to a speed of over 6 mph (10 km/h) after a full application of the brakes, the hazard warning lamps are deactivated automatically.

- ❗ The hazard warning lamps still operate if the ignition is switched off.

Headlamp cleaning system

The headlamps are cleaned automatically if the "Wipe with washer fluid" function is operated five times while the lights are on and the engine is running (> page 125). When you switch off the ignition, the automatic headlamp cleaning system is reset and counting is resumed from 0.

Active light function

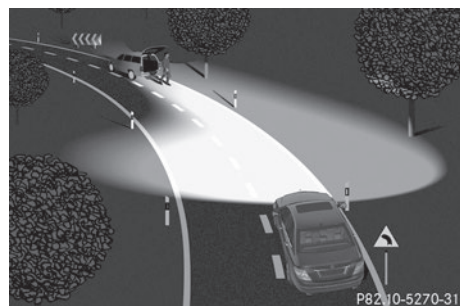

The active light function is a system that moves the headlamps according to the steering movements of the front wheels. In this way, relevant areas remain illuminated while driving. This allows you to recognize pedestrians, cyclists and animals.

Active: when the lights are switched on.

Cornering light function

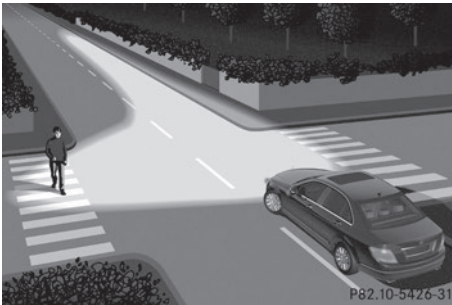

The cornering light function improves the illumination of the road over a wide angle in the direction you are turning, enabling better visibility in tight bends, for example. The cornering light function can only be activated when the low-beam headlamps are switched on.

Active:

- if you are driving at speeds below 25mph (40 km/h) and switch on the turn signal or turn the steering wheel.
- if you are driving at speeds between 25 mph (40 km/h) and 45 mph (70 km/h) and turn the steering wheel.

Not active: if you are driving at speeds above 25 mph (40 km/h) or switch off the turn signals or turn the steering wheel to the straight-ahead position.

The cornering light function may remain lit for a short time, but is automatically switched off after no more than three minutes.

Adaptive Highbeam Assist

Important safety notes

WARNING

Adaptive Highbeam Assist does not recognize road users:

- who have no lights, e.g. pedestrians
- who have poor lighting, e.g. cyclists
- whose lighting is blocked, e.g. by a barrier

In very rare cases, Adaptive Highbeam Assist may fail to recognize other road users that have lights, or may recognize them too late. In this or similar situations, the automatic high-beam headlamps will not be deactivated or activated regardless. There is a risk of an accident.

Always carefully observe the traffic conditions and switch off the high-beam headlamps in good time.

Adaptive Highbeam Assist cannot take into account road, weather or traffic conditions. Adaptive Highbeam Assist is only an aid. You are responsible for adjusting the vehicle's lighting to the prevailing light, visibility and traffic conditions.

In particular, the detection of obstacles can be restricted if there is:

- poor visibility, e.g. due to fog, heavy rain or snow
- dirt on the sensors or the sensors are obscured

General notes

You can use this function to set the headlamps to change between low beam and high beam automatically. The system recognizes vehicles with their lights on, either approaching from the opposite direction or traveling in front of your vehicle, and consequently switches the headlamps from high beam to low beam.

The system automatically adapts the low-beam headlamp range depending on the distance to the other vehicle. Once the

system no longer detects any other vehicles, it reactivates the high-beam headlamps.

The system's optical sensor is located behind the windshield near the overhead control panel.



Switching Adaptive Highbeam Assist on/off

- ▶ **To activate:** activate the Adaptive Highbeam Assist function using the on-board computer (▷ page 216).
- ▶ Turn the light switch to **AUTO**.
- ▶ Press the combination switch beyond the pressure point in the direction of arrow ① (▷ page 116).
The  indicator lamp in the multifunction display lights up if it is dark and the light sensor activates the low-beam headlamps.



If you are driving at speeds above approximately 28 mph (45 km/h):

The headlamp range is set automatically depending on the distance between the vehicle and other road users.

If you are driving at speeds above approximately 35 mph (55 km/h) and no other road users have been detected:

The high-beam headlamps are switched on automatically. The  indicator lamp in the instrument cluster also lights up.

If you are driving at speeds below approximately 30 mph (45 km/h) or other road users have been detected or the roads are adequately lit:

The high-beam headlamps are switched off automatically. The  indicator lamp in the instrument cluster goes out. The  indicator lamp in the multifunction display remains lit.

- ▶ **To deactivate:** move the combination switch back to its normal position. The  indicator lamp in the multifunction display goes out.

Headlamps fogged up on the inside

The headlamps may fog up on the inside if there is high atmospheric humidity.



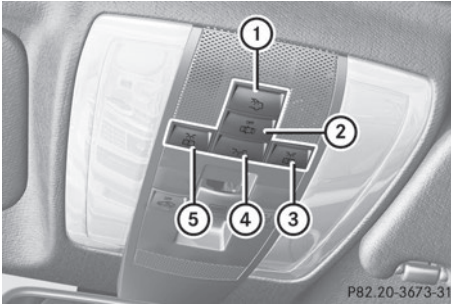

- ▶ Switch on the lights and drive off. The level of moisture diminishes, depending on the length of the journey and the weather conditions (humidity and temperature).
- If the level of moisture does not diminish:
- ▶ Have the headlamps checked at a qualified specialist workshop.

Interior lighting

Overview of interior lighting



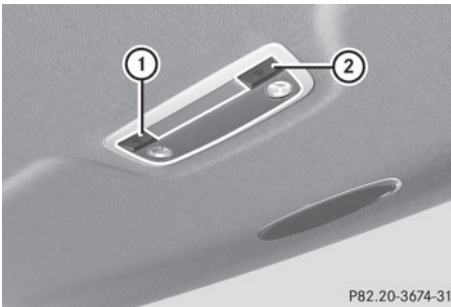

Front overhead control panel

- ①  Switches the rear interior lighting on/off
- ②  Switches the automatic interior lighting control on/off
- ③  Switches the right-hand front reading lamp on/off
- ④  Switches the front interior lighting on/off
- ⑤  Switches the left-hand front reading lamp on/off



Rear-compartment overhead control panel

- ①  Switches the right-hand reading lamp on/off
- ②  Switches the left-hand reading lamp on/off

Interior lighting control

General notes

In order to prevent the vehicle's battery from discharging, the interior lighting functions are automatically deactivated after some time unless the SmartKey is in position **2** in the ignition lock.

Automatic interior lighting control

► **To activate/deactivate:** press the  button.

When the automatic interior lighting control is activated, the button is flush with the overhead control panel.

The interior lighting automatically switches on if you:

- unlock the vehicle
- open a door
- remove the SmartKey from the ignition lock.

The interior light is activated for a short while when the SmartKey is removed from the ignition lock. You can activate this delayed switch-off using the on-board computer (> page 217).

Manual interior lighting control

► **To switch the front interior lighting on/off:** press the  button.

► **To switch the interior lighting on/off:** press the  button.

► **To switch the reading lamps on/off:** press the  button.

Crash-responsive emergency lighting

The interior lighting is activated automatically if the vehicle is involved in an accident.

- ▶ **To switch off the crash-responsive emergency lighting:** press the hazard warning lamp button.

or

- ▶ Lock and then unlock the vehicle using the SmartKey.

Replacing bulbs**Important safety notes****Xenon bulbs** **DANGER**

Xenon bulbs carry a high voltage. You can get an electric shock if you remove the cover of the Xenon bulb and touch the electrical contacts. There is a risk of fatal injury.

Never touch the parts or the electrical contacts of the Xenon bulb. Always have work on the Xenon bulbs carried out at a qualified specialist workshop.

If your vehicle is equipped with Xenon bulbs, you can recognize this by the following: the cone of light from the Xenon bulbs moves from the top to the bottom and back again when you start the engine. For this to be observed, the lights must be switched on before starting the engine.

Bulbs and lamps are an important aspect of vehicle safety. You must therefore make sure that these function correctly at all times. Have the headlamp setting checked regularly.

Other bulbs **WARNING**

Bulbs, lamps and connectors can get very hot when operating. If you change a bulb, you could burn yourself on these components. There is a risk of injury.

Allow these components to cool down before changing a bulb.

Do not use a bulb that has been dropped or if its glass tube has been scratched.

The bulb may explode if:

- you touch it
- it is hot
- you drop it
- you scratch it

Only operate bulbs in enclosed lamps designed for that purpose. Only install spare bulbs of the same type and the specified voltage.

Marks on the glass tube reduce the service life of the bulbs. Do not touch the glass tube with your bare hands. If necessary, clean the glass tube when cold with alcohol or spirit and rub it off with a lint-free cloth.

Protect bulbs from moisture during operation. Do not allow bulbs to come into contact with liquids.

There are bulbs other than the Xenon bulbs that you cannot replace. Replace only the bulbs listed (▷ page 121). Have the bulbs that you cannot replace yourself changed at a qualified specialist workshop.

If you require assistance changing bulbs, consult a qualified specialist workshop.

If the new bulb still does not light up, consult a qualified specialist workshop.

Bulbs and lamps are an important aspect of vehicle safety. You must therefore make sure that these function correctly at all times. Have the headlamp setting checked regularly.

Overview: changing bulbs/bulb types

You can change the following bulbs. The bulb type can be found in the legend.

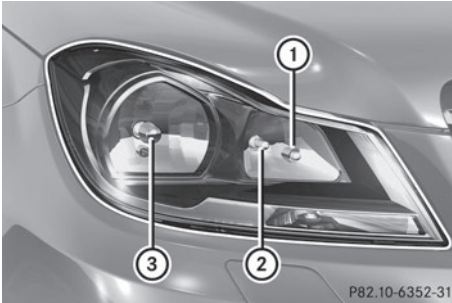

P82.10-6352-31

Halogen headlamps

- ① Parking lamp/standing lamp: W 5 W
- ② High-beam headlamp: H7 55 W
- ③ Low-beam headlamp: H7 55 W



P82.10-6353-31

Bi-Xenon headlamps

- ① Cornering lamp: H7 55 W

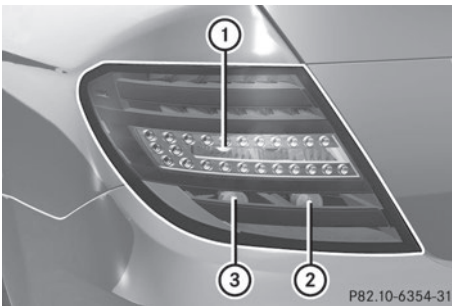

P82.10-6354-31

Tail lamp

- ① Backup lamp: P 21 W
- ② Brake lamp: P 21 W
- ③ Brake lamp/parking lamp: P 21 W

Changing the front bulbs

Low-beam headlamps (halogen headlamps)

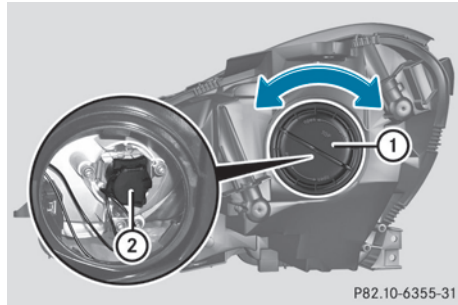

P82.10-6355-31

- ▶ Switch off the lights.
- ▶ Open the hood.
- ▶ Turn housing cover ① counter-clockwise and pull it out.
- ▶ Turn bulb holder ② counter-clockwise and pull it out.
- ▶ Take the bulb out of bulb holder ②.
- ▶ Insert the new bulb into bulb holder ②.
- ▶ Insert bulb holder ② into the lamp and turn it clockwise.
- ▶ Align housing cover ① and turn it clockwise until it engages.

High-beam headlamps (halogen headlamps)

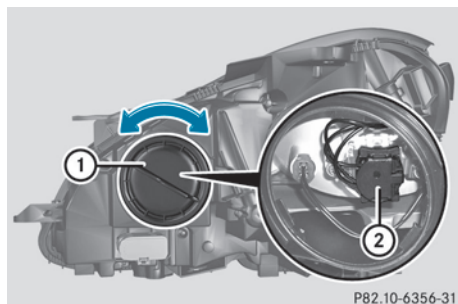

P82.10-6356-31

- ▶ Switch off the lights.
- ▶ Open the hood.

- ▶ Turn housing cover ① counter-clockwise and pull it out.
- ▶ Turn bulb holder ② counter-clockwise and pull it out.
- ▶ Take the bulb out of bulb holder ②.
- ▶ Insert the new bulb into bulb holder ②.
- ▶ Insert bulb holder ② into the lamp and turn it clockwise.
- ▶ Align housing cover ① and turn it clockwise until it engages.

Parking lamps/standing lamps (halogen headlamps)

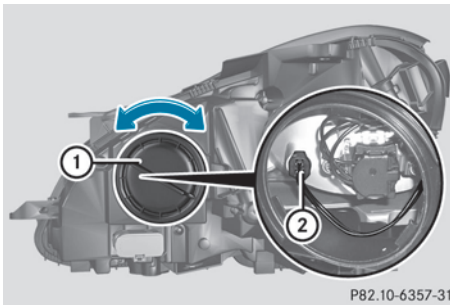

- ▶ Switch off the lights.
- ▶ Open the hood.
- ▶ Turn housing cover ① counter-clockwise and pull it out.
- ▶ Pull out bulb holder ②.
- ▶ Take the bulb out of bulb holder ②.
- ▶ Insert the new bulb into bulb holder ②.
- ▶ Insert bulb holder ②.
- ▶ Align housing cover ① and turn it clockwise until it engages.

Cornering light function (Bi-Xenon headlamps)

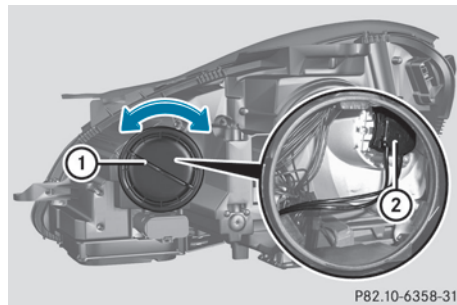

- ▶ Switch off the lights.
- ▶ Open the hood.
- ▶ Turn housing cover ① counter-clockwise and pull it out.
- ▶ Turn bulb holder ② counter-clockwise and pull it out.
- ▶ Take the bulb out of bulb holder ②.
- ▶ Insert the new bulb into bulb holder ②.
- ▶ Insert bulb holder ② into the lamp and turn it clockwise.
- ▶ Align housing cover ① and turn it clockwise until it engages.

Changing the rear bulbs

Opening and closing the side trim panels

You must open the side trim panel in the trunk and remove the first-aid kit before you can change the bulbs in the tail lamps.

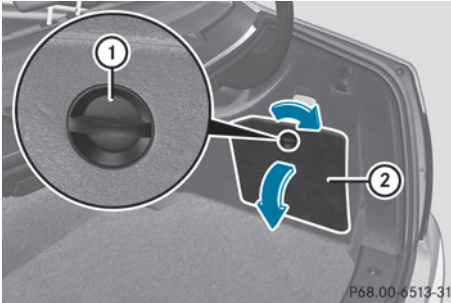

P68.00-6513-31

Right-hand side trim panel

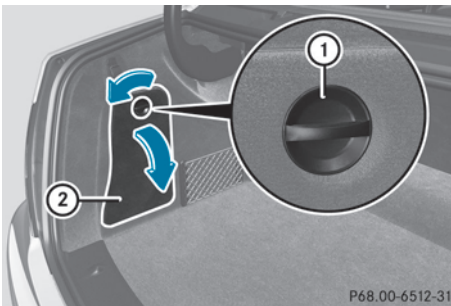

P68.00-6512-31

Left-hand side trim panel (vehicles with a sound system)

- ▶ **To open:** turn rotary catch ① 90° in the direction of the arrow and remove side trim panel ②.
- ▶ **To close:** insert side trim panel ② and turn rotary catch ① 90° in the opposite direction to the arrow.

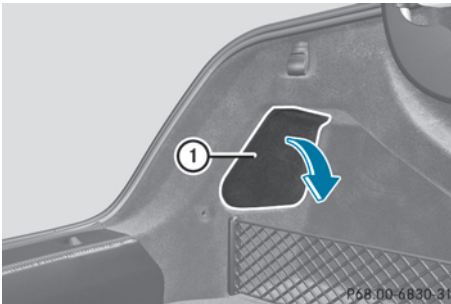

P68.00-6830-31

Left-hand side trim panel (vehicles without a sound system)

- ▶ **To open:** loosen side trim panel ① at the top and fold it down in the direction of the arrow.
- ▶ **To close:** insert side panel ①.

Tail lamp

- ▶ Switch off the lights.
- ▶ Open the trunk.
- ▶ Open the side trim panel (▷ page 123).

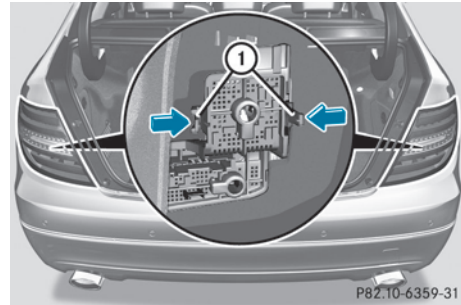

P82.10-6359-31

- ▶ Remove the tail lamp connector
- ▶ Simultaneously press retaining lugs ① in the direction of the arrow and slightly pull out the bulb holder with the bulbs.
- ▶ Remove the connector for LED light functions from the top of the bulb holder.
- ▶ Pull the bulb holder out with the bulbs.

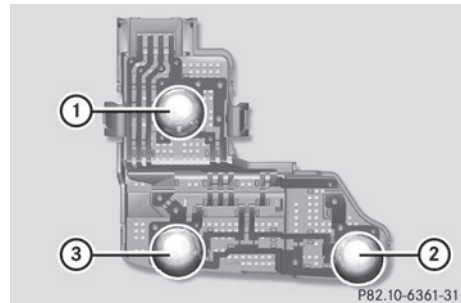

P82.10-6361-31

- ① Backup Light
- ② Brake lamp
- ③ Parking lamp/brake lamp

- ▶ Press the respective bulb ①, ② or ③ back and turn it counter-clockwise to remove it from the bulb holder.
- ▶ Insert the new bulb into the bulb holder and turn it clockwise.
- ▶ Reinsert the connector for LED light functions in the bulb holder.
- ▶ Insert the bulb holder again and lock it in place.
- ▶ Insert the tail lamp connector.
- ▶ Close the side trim panel (▷ page 123).

Windshield wipers

Switching the windshield wipers on/off

- ❗ Do not operate the windshield wipers when the windshield is dry, as this could damage the wiper blades. Moreover, dust that has collected on the windshield can scratch the glass if wiping takes place when the windshield is dry.
- ❗ If the windshield wipers leave smears on the windshield after the vehicle has been washed in an automatic car wash, wax or other residues may be the reason for this. Clean the windshield using washer fluid after washing the vehicle in an automatic car wash.

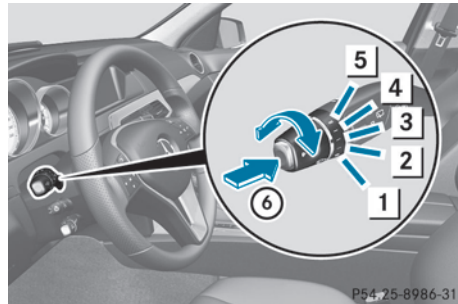

Combination switch

- 1 0 Windshield wiper off
- 2 ... Intermittent wipe, low⁵
- 3 Intermittent wipe, high⁶
- 4 — Continuous wipe, slow
- 5 = Continuous wipe, fast
- 6 Single wipe/ To wipe the windshield using washer fluid

- ▶ Switch on the ignition.
- ▶ Turn the combination switch to the corresponding position.

❗ Intermittent wiping with rain sensor: due to optical influences and the windshield becoming dirty in dry weather conditions, the windshield wipers may be activated inadvertently. This could then damage the windshield wiper blades or scratch the windshield.

For this reason, you should always switch off the windshield wipers in dry weather.

In the ... or position, the appropriate wiping frequency is set automatically according to the intensity of the rain. In the position, the rain sensor is more sensitive than in the ... position, causing the windshield wipers to wipe more frequently.

If the wiper blades are worn, the windshield will no longer be wiped properly. This could prevent you from observing the traffic

⁵ Rain sensor set to low sensitivity.

⁶ Rain sensor set to high sensitivity.

conditions. Replace the wiper blades twice a year, ideally in spring and fall.

Replacing the wiper blades

Important safety notes

WARNING

If the windshield wipers begin to move while you are changing the wiper blades, you could be trapped by the wiper arm. There is a risk of injury.

Always switch off the windshield wipers and ignition before changing the wiper blades.

! Never open the hood if a windshield wiper arm has been folded away from the windshield.

Never fold a windshield wiper arm without a wiper blade back onto the windshield.

Hold the windshield wiper arm firmly when you change the wiper blade. If you release the windshield wiper arm without a wiper blade and it falls onto the windshield, the windshield may be damaged by the force of the impact.

Mercedes-Benz recommends that you have the wiper blades changed at a qualified specialist workshop.

! To avoid damaging the wiper blades, make sure that you touch only the wiper arm of the wiper.

Changing the windshield wiper blades

Removing the wiper blades

- ▶ Remove the SmartKey from the ignition lock or turn it to position **0** (KEYLESS-GO).
- ▶ Fold the wiper arm away from the windshield until it engages.

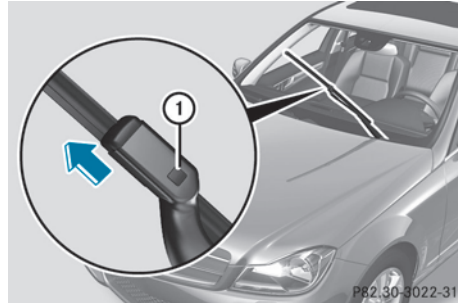

- ▶ Firmly press release knob ① and pull the wiper blade upwards from the wiper arm in the direction of the arrow.

Installing the wiper blades

- ▶ Position the new wiper blade in the retainer on the wiper arm and slide it into place in the opposite direction to the arrow. The wiper blade audibly engages.
- ▶ Make sure that wiper blade is seated correctly.
- ▶ Fold the wiper arm back onto the windshield.

Problems with the windshield wipers

Problem	Possible causes/consequences and ► Solutions
The windshield wipers are jammed.	<p>Leaves or snow, for example, may be obstructing the windshield wiper movement. The wiper motor has been deactivated.</p> <ul style="list-style-type: none"> ► For safety reasons, you should remove the SmartKey from the ignition lock. <p>or</p> <ul style="list-style-type: none"> ► Switch off the engine using the Start/Stop button and open the driver's door. ► Remove the cause of the obstruction. ► Switch the windshield wipers back on.
The windshield wipers fail completely.	<p>The windshield wiper drive is malfunctioning.</p> <ul style="list-style-type: none"> ► Select another wiper speed on the combination switch. ► Have the windshield wipers checked at a qualified specialist workshop.
The windshield washer fluid from the spray nozzles no longer hits the center of the windshield.	<p>The spray nozzles are misaligned.</p> <ul style="list-style-type: none"> ► Have the spray nozzles adjusted at a qualified specialist workshop.

Useful information	130
Overview of climate control systems	130
Operating the climate control systems	135
Setting the air vents	142

Useful information

- i** This Operator's Manual describes all models and all standard and optional equipment of your vehicle available at the time of publication of the Operator's Manual. Country-specific differences are possible. Please note that your vehicle may not be equipped with all features described. This also applies to safety-related systems and functions.
- i** Read the information on qualified specialist workshops: (> page 25).

Overview of climate control systems

Important safety notes

Observe the settings recommended on the following pages. The windows could otherwise fog up.

To prevent the windows from fogging up:

- switch off climate control only briefly
- switch on air-recirculation mode only briefly
- switch on the cooling with air dehumidification function
- switch on the defrost windshield function briefly, if required

Climate control regulates the temperature and the humidity in the vehicle interior and filters undesirable substances out of the air.

Climate control can only be operated when the engine is running. Optimum operation is only achieved with the side windows and roof closed.

The residual heat function can only be activated or deactivated with the ignition switched off (> page 141).

- i** Ventilate the vehicle for a brief period during warm weather, e.g. using the convenience opening feature (> page 89). This will speed up the cooling process and the desired vehicle interior temperature will be reached more quickly.

- i** The integrated filter filters out most particles of dust and soot and completely filters out pollen. It also reduces gaseous pollutants and odors. A clogged filter reduces the amount of air supplied to the vehicle interior. For this reason, you should always observe the interval for replacing the filter, which is specified in the Maintenance Booklet. As it depends on environmental conditions, e.g. heavy air pollution, the interval may be shorter than stated in the Maintenance Booklet.
- i** It is possible that the dehumidification function of the climate control system may be activated automatically an hour after the SmartKey has been removed. The vehicle is then ventilated for 30 minutes.

Control panel for dual-zone automatic climate control

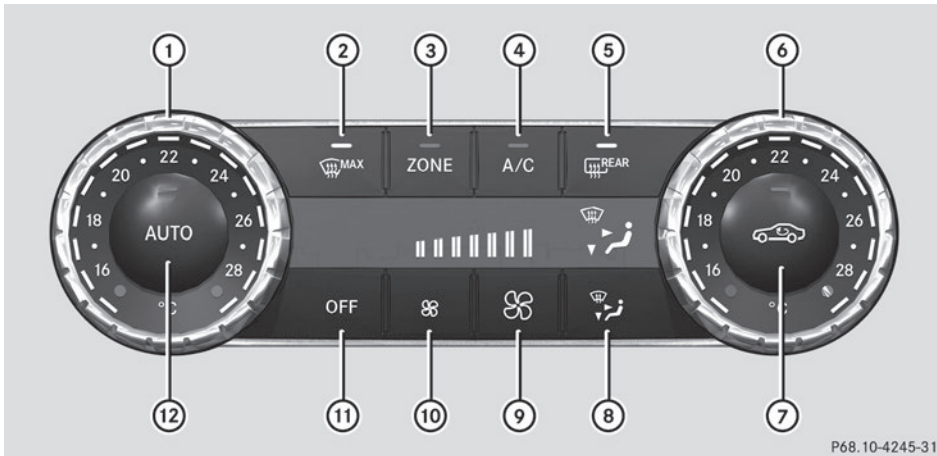

Canada only

- ① To set the temperature, left (▷ page 138)
- ② To defrost the windshield (▷ page 139)
- ③ To switch the ZONE function on/off (▷ page 139)
- ④ To switch cooling with air dehumidification on/off (▷ page 135)
- ⑤ To switch the rear window defroster on/off (▷ page 140)
- ⑥ To set the temperature, right (▷ page 138)
- ⑦ To activate/deactivate air-recirculation mode (▷ page 141)
- ⑧ To set the air distribution (▷ page 138)
- ⑨ To increase the airflow (▷ page 139)
- ⑩ To reduce the airflow (▷ page 139)
- ⑪ To switch climate control on/off (▷ page 135)
- ⑫ To set climate control to automatic (▷ page 137)

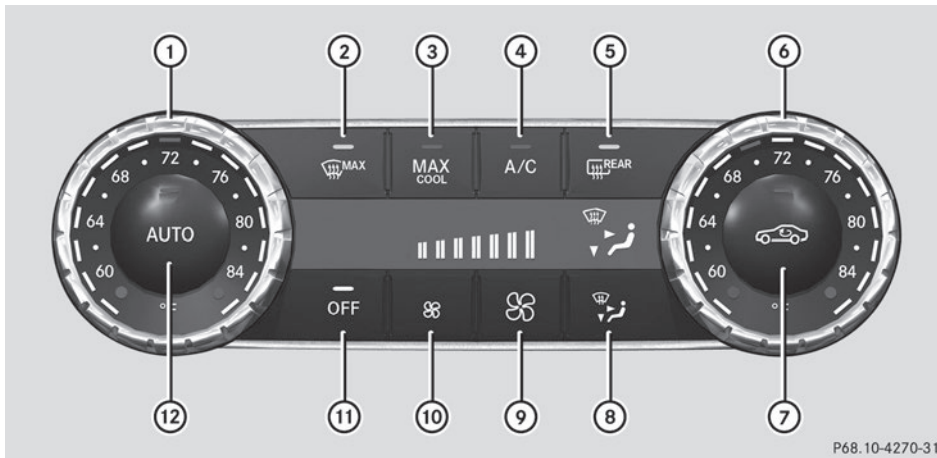

P68.10-4270-31

Climate control

USA only

- ① To set the temperature, left (▷ page 138)
- ② To defrost the windshield (▷ page 139)
- ③ To switch maximum cooling on/off (▷ page 140)
- ④ To switch cooling with air dehumidification on/off (▷ page 135)
- ⑤ To switch the rear window defroster on/off (▷ page 140)
- ⑥ To set the temperature, right (▷ page 138)
- ⑦ To activate/deactivate air-recirculation mode (▷ page 141)
- ⑧ To set the air distribution (▷ page 138)
- ⑨ To increase the airflow (▷ page 139)
- ⑩ To reduce the airflow (▷ page 139)
- ⑪ To switch climate control on/off (▷ page 135)
- ⑫ To set climate control to automatic (▷ page 137)

Notes on using climate control

Automatic climate control

The following contains notes and recommendations on optimum use of dual-zone automatic climate control.

- Activate climate control using the **AUTO** and **A/C** buttons. The indicator lamps in the **AUTO** and **A/C** buttons light up.
- Set the temperature to 72 °F (22 °C).
- Only use the "windshield defrosting" function briefly until the windshield is clear again.

- Only use air-recirculation mode briefly, e.g. if there are unpleasant outside odors or when in a tunnel. The windows could otherwise fog up, since no fresh air is drawn into the vehicle in air-recirculation mode.
- Use the ZONE function to adopt the temperature settings on the driver's side for the front-passenger side as well. The indicator lamp in the **ZONE** button goes out.

ECO start/stop function

During automatic engine switch-off, the ECO start/stop function only operates at a reduced capacity. If you require the full

climate control output, you can switch off the ECO start/stop function by pressing the ECO button (▷ page 152).

- i** The ECO start/stop function is not available on AMG vehicles.

Control panel for 3-zone automatic climate control

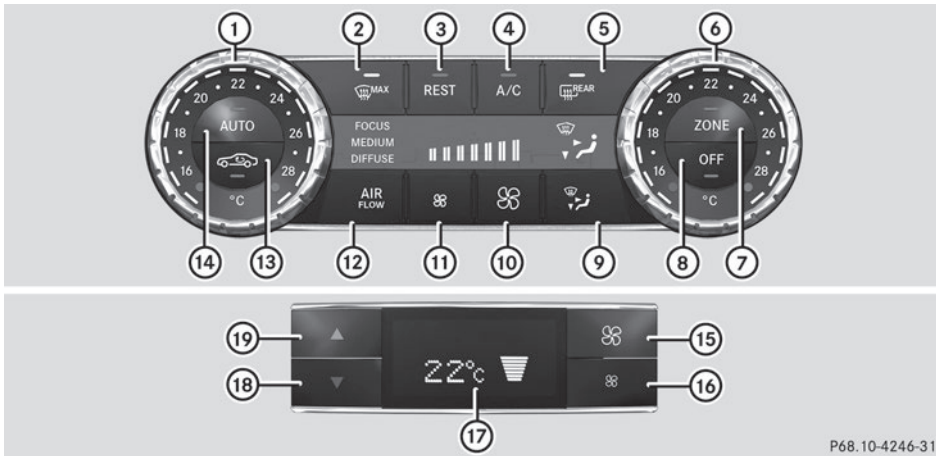

P68.10-4246-31

Canada only

Front control panel

- ① To set the temperature, left (▷ page 138)
- ② To defrost the windshield (▷ page 139)
- ③ To switch the residual heat function on/off (▷ page 141)
- ④ To switch cooling with air dehumidification on/off (▷ page 135)
- ⑤ To switch the rear window defroster on/off (▷ page 140)
- ⑥ To set the temperature, right (▷ page 138)
- ⑦ To switch the ZONE function on/off (▷ page 139)
- ⑧ To switch climate control on/off (▷ page 135)
- ⑨ To set the air distribution (▷ page 138)
- ⑩ To increase the airflow (▷ page 139)
- ⑪ To reduce the airflow (▷ page 139)
- ⑫ To adjust airflow (▷ page 137)
- ⑬ To activate/deactivate air-recirculation mode (▷ page 141)
- ⑭ To set climate control to automatic (▷ page 137)

Rear control panel

- ⑮ To increase the airflow (▷ page 139)
- ⑯ To reduce the airflow (▷ page 139)
- ⑰ Display
- ⑱ To reduce the temperature (▷ page 138)
- ⑲ To increase the temperature (▷ page 138)

Notes on using 3-zone automatic climate control

Automatic climate control

The following contains instructions and recommendations to enable you to get the most out of your automatic climate control.

- Activate climate control using the **AUTO** and **A/C** buttons. The indicator lamps in the **AUTO** and **A/C** buttons light up.
- In automatic mode, you can also use the **AIR FLOW** button to adjust airflow (FOCUS/MEDIUM/DIFFUSE). The MEDIUM level is recommended.
- Set the temperature to 72 °F (22 °C).
- Only use the "windshield defrosting" function briefly until the windshield is clear again.
- Only use air-recirculation mode briefly, e.g. if there are unpleasant outside odors or when in a tunnel. The windows could otherwise fog up, since no fresh air is drawn into the vehicle in air-recirculation mode.
- Use the ZONE function to adopt the temperature settings on the driver's side for the front-passenger side and the rear compartment as well. The indicator lamp in the **ZONE** button goes out.
- Use the residual heat function if you want to heat or ventilate the vehicle interior when the ignition is switched off. The residual heat function can only be activated or deactivated with the ignition switched off.

ECO start/stop function

During automatic engine switch-off, the ECO start/stop function only operates at a reduced capacity. If you require the full climate control output, you can switch off the ECO start/stop function by pressing the ECO button (▷ page 152).

- **i** The ECO start/stop function is not available on AMG vehicles.

Operating the climate control systems

Switching climate control on/off

General notes

When the climate control is switched off, the air supply and air circulation are also switched off. The windows could fog up. Therefore, switch off climate control only briefly

- **i** Switch on climate control primarily using the **AUTO** button (▷ page 137).

Activating/deactivating

- ▶ Turn the SmartKey to position **2** in the ignition lock (▷ page 147).
 - ▶ **To activate:** press the **AUTO** button. The indicator lamp in the **AUTO** button lights up. Airflow and air distribution are set to automatic mode.
- or
- ▶ Press the **OFF** button. The indicator lamp in the **OFF** button goes out. The previously selected settings are restored.
 - ▶ **To deactivate:** press the **OFF** button. The indicator lamp in the **OFF** button lights up.

Activating/deactivating cooling with air dehumidification

General notes



If you deactivate the "Cooling with air dehumidification" function, the air inside the vehicle will not be cooled. The air inside the vehicle will also not be dehumidified. The windows can fog up more quickly. Therefore, deactivate the cooling with air dehumidification function only briefly.

The "Cooling with air dehumidification" function is only available when the engine is running. The air inside the vehicle is cooled



and dehumidified according to the temperature selected.

Condensation may drip from the underside of the vehicle when it is in cooling mode. This is normal and not a sign that there is a malfunction.

Activating/deactivating

- ▶ **To activate:** press the  button.
The indicator lamp in the  button lights up.

i When the "Cooling with air dehumidification" function is activated, one of the indicator lamps on the auxiliary heating button will light up on vehicles with auxiliary heating.

- ▶ **To deactivate:** press the  button.
The indicator lamp in the  button goes out. The "Cooling with air dehumidification" function has a delayed switch-off feature.

Problems with the "Cooling with air dehumidification" function

Problem	Possible causes/consequences and ► Solutions
The indicator lamp in the  button flashes three times or remains off. The "Cooling with air dehumidification" function cannot be switched on.	Cooling with air dehumidification has been deactivated due to a malfunction. ► Visit a qualified specialist workshop.

Setting climate control to automatic



General notes

In automatic mode, the set temperature is maintained automatically at a constant level. The system automatically regulates the temperature of the dispensed air, the airflow and the air distribution.

The automatic mode functions optimally when the "Cooling with air dehumidification" function is activated. If necessary, cooling with air dehumidification can be deactivated.

If you deactivate the "Cooling with air-dehumidification" function, the air inside the vehicle will not be cooled. The air inside the vehicle will also not be dehumidified. The windows can fog up more quickly. Therefore, deactivate the cooling with air-dehumidification function only briefly.



Activating/switching

- Turn the SmartKey to position **2** in the ignition lock (▷ page 147).
- Set the desired temperature.
- **To activate:** press the  button. The indicator lamp in the  button lights up. Automatic air distribution and airflow are activated.

3-zone automatic climate control: when automatic mode is activated, you can adjust airflow (▷ page 137).

- **To select manually:** press the  button.

or



- Press the  or  button. The indicator lamp in the  button goes out. Automatic air distribution and airflow are deactivated.

Adjusting airflow

This function is only available with 3-zone automatic climate control.

In automatic mode you can select the following airflow settings:

- FOCUS high airflow that is set slightly cooler
- MEDIUM medium airflow, standard setting
- DIFFUSE low airflow that is set slightly warmer and with less draft

- Turn the SmartKey to position **2** in the ignition lock (▷ page 147).
- Press the  button.
- Press the  button repeatedly until the required airflow setting appears in the display.

Setting the temperature

Dual-zone automatic climate control

Different temperatures can be set for the driver's and front-passenger sides.

- ▶ Turn the SmartKey to position **2** in the ignition lock (▷ page 147).
- ▶ **To increase/reduce:** turn control ① or ⑥ clockwise or counter-clockwise (▷ page 131).

Only change the temperature setting in small increments. Start at 72 °F (22 °C).

3-zone automatic climate control⁷

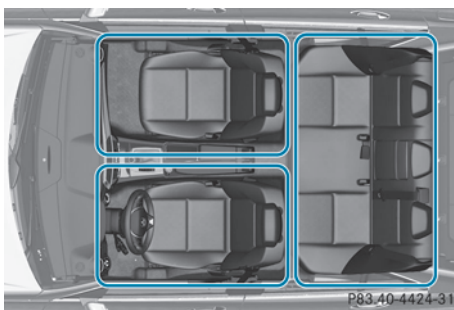

Automatic climate control zones







You can select different temperature settings for the driver's and front-passenger sides as well as for the rear compartment.

- ▶ Turn the SmartKey to position **2** in the ignition lock (▷ page 147).
- ▶ **To increase/reduce the temperature in the front:** turn control ① or ⑥ clockwise or counter-clockwise (▷ page 134).
Only change the temperature setting in small increments. Start at 72 °F (22 °C).
- ▶ **To increase/reduce the temperature in the rear compartment using the front control panel:** press the **ZONE** button. The indicator lamp in the **ZONE** button goes out.

- ▶ Turn control ① clockwise or counter-clockwise (▷ page 134).
Only change the temperature setting in small increments. Start at 72 °F (22 °C).
 - ▶ **To increase/reduce the temperature in the rear compartment using the rear control panel:** press the **▲** or **▼** button on the rear control panel.
Only change the temperature setting in small increments. Start at 72 °F (22 °C).
- i** If you leave the vehicle parked for longer than 30 minutes, the temperature setting for the rear compartment then switches back to 72 °F (22 °C).

Setting the air distribution

Air distribution settings

-  Directs air through the center and side air vents
-  Directs air through the footwell air vents
-  Directs air through the center, side and footwell vents
-  Directs air through the defroster vents
-  Directs the airflow through the defroster, center and side air vents⁸
-  Directs air through the defroster and footwell vents
-  Directs air through the defroster, center, side and footwell vents⁸

- i** Regardless of the air distribution setting, airflow is always directed through the side air vents. The side air vents can only be closed when the controls on the side air vents are turned downwards.



⁷ Canada only.

⁸ Canada only.

Adjusting

- ▶ Turn the SmartKey to position **2** in the ignition lock (▷ page 147).
- ▶ Press the  button repeatedly until the desired symbol appears in the display. The indicator lamp in the **AUTO** button goes out. Automatic control is deactivated and the air distribution is controlled according to the selected setting.



Setting the airflow

- ▶ Turn the SmartKey to position **2** in the ignition lock (▷ page 147).
- ▶ **To increase/reduce:** press the  or  button.
- i** You can use 3-zone automatic climate control to set the airflow in the rear compartment separately.



If the battery is not sufficiently charged, blower output may be reduced. As soon as the battery is sufficiently charged, full blower output will be available.

Switching the ZONE function on/off

This function is only available in vehicles for Canada.



- ▶ **To activate:** press the  button. The indicator lamp in the  button lights up.
Dual-zone automatic climate control: the temperature setting for the driver's side is not adopted for the front-passenger side.
3-zone automatic climate control: the temperature setting for the driver's side is not adopted for the front-passenger side and the rear compartment.

When the buttons for temperature, airflow or air distribution are pressed, the temperature setting on the driver's side is not adopted for the other climate control zones.

- ▶ **To deactivate:** press the  button. The indicator lamp in the  button goes out.
Dual-zone automatic climate control: the temperature setting for the driver's side is adopted for the front-passenger side.
3-zone automatic climate control: the temperature setting for the driver's side is adopted for the front-passenger side and the rear compartment.

Defrosting the windshield



You can use this function to defrost the windshield or to defrost the inside of the windshield and the side windows.

- i** You should only select the "windshield defrosting" function until the windshield is clear again.
- ▶ Turn the SmartKey to position **2** in the ignition lock (▷ page 147).
- ▶ **To activate:** press the  button. The indicator lamp in the  button lights up.

The climate control system switches to the following functions:

- high airflow
- high temperature
- air distribution to the windshield and front side windows
- air-recirculation mode off

If the battery is not sufficiently charged, blower output may be reduced. As soon as the battery is sufficiently charged, full blower output will be available.

- ▶ **To deactivate:** press the  button. The indicator lamp in the  button goes out. The previously selected settings are restored. Air-recirculation mode remains deactivated.

or

- ▶ Press the **AUTO** button.
The indicator lamp in the  button goes out. Airflow and air distribution are set to automatic mode.

or

- ▶ Turn temperature control ① or ⑥ clockwise or counter-clockwise (▷ page 131), (▷ page 134).

or



- ▶ Press the  or  button.

MAX COOL maximum cooling

The MAX COOL function is only available in vehicles for the USA.



MAX COOL is only operational when the engine is running.

When you activate MAX COOL, climate control switches to the following functions:

- maximum cooling
- maximum airflow
- air-recirculation mode on
- ▶ **To activate:** press the  button.
The indicator lamp in the button lights up.
- ▶ **To activate:** press the  button again.
The indicator lamp goes out. The previously selected settings are restored.



Defrosting the windows

Windows fogged up on the inside

- ▶ Activate the  cooling with air dehumidification function.
- ▶ Activate automatic mode **AUTO**.
- ▶ Adjust the side air vents so that the warmed air is directed to the side windows.
- ▶ If the windows continue to fog up, activate the  "Windshield defrosting" function.

i You should only select this setting until the windshield is clear again.

Windows fogged up on the outside

- ▶ Activate the windshield wipers.
- ▶ Press the  button repeatedly until the  or  symbol appears in the display.
- ▶ Adjust the side air vents so that no air is directed to the side windows.



Rear window defroster

General notes

The rear window defroster has a high current draw. You should therefore switch it off as soon as the rear window is clear. Otherwise, the rear window defroster switches off automatically after several minutes.

If the battery voltage is too low, the rear window defroster may switch off.

Activating/deactivating

- ▶ Turn the SmartKey to position **2** in the ignition lock (▷ page 147).
- ▶ Press the  button.
The indicator lamp in the  button lights up or goes out.

Problems with the rear window defroster

Problem	Possible causes/consequences and ► Solutions
The rear window defroster has deactivated prematurely or cannot be activated.	The battery has not been sufficiently charged. ► Switch off any consumers that are not required, e.g. reading lamps, interior lighting or the seat heating. When the battery is sufficiently charged, the rear window defroster can be activated again.

Activating/deactivating air-recirculation mode



General notes

You can deactivate the flow of fresh air if unpleasant odors are entering the vehicle from outside. The air already inside the vehicle will then be recirculated.



If you switch on air-recirculation mode, the windows can fog up more quickly, in particular at low temperatures. Only use air-recirculation mode briefly to prevent the windows from fogging up.

The operation of air-recirculation mode is the same for all control panels.

Activating/deactivating

- Turn the SmartKey to position **2** in the ignition lock (► page 147).
- **To activate:** press the  button. The indicator lamp in the  button lights up.

- i** In the event of high pollution levels⁹ or at high outside temperatures, air-recirculation mode is automatically activated. When air-recirculation mode is activated automatically, the indicator lamp in the  button is not lit. Outside air is added after about 30 minutes.

- **To deactivate:** press the  button. The indicator lamp in the  button goes out.

- i** Air-recirculation mode deactivates automatically:

- after approximately five minutes at outside temperatures below approximately 41 °F (5 °C)
- after approximately five minutes if cooling with air dehumidification is deactivated
- after approximately 30 minutes at outside temperatures above approximately 41 °F (5 °C) if the "Cooling with air dehumidification" function is activated

Activating/deactivating the residual heat function

General notes

The residual heat function is only available in vehicles for Canada with automatic climate control.

It is possible to make use of the residual heat of the engine to continue heating the vehicle for approximately 30 minutes after the engine has been switched off. The heating time depends on the temperature that has been set.

- i** The blower will run at a low speed regardless of the airflow setting.

⁹ 3-zone automatic climate control only.

- i** If you activate the residual heat function at high temperatures, only the ventilation will be activated. The blower runs at medium speed.

Activating/deactivating

- ▶ Turn the SmartKey to position **0** in the ignition lock (▷ page 147) or remove it.
- ▶ **To activate:** press the **REST** button. The indicator lamp in the **REST** button lights up.
- i** If the residual heat function is activated, the windows may fog up on the inside.
- ▶ **To deactivate:** press the **REST** button. The indicator lamp in the **REST** button goes out.
- i** Residual heat is deactivated automatically:
 - after approximately 30 minutes
 - when the ignition is switched on
 - if the battery voltage drops

Setting the air vents

Important safety notes

⚠ WARNING

Very hot or very cold air can flow from the air vents. This could result in burns or frostbite in the immediate vicinity of the air vents. There is a risk of injury.

Make sure that all vehicle occupants always maintain a sufficient distance to the air outlets. If necessary, redirect the airflow to another area of the vehicle interior.

In order to ensure the direct flow of fresh air through the air vents into the vehicle interior, please observe the following notes:

- keep the air inlet between the windshield and the hood free of blockages, such as ice, snow or leaves.
- never cover the air vents or air intake grilles in the vehicle interior.

- i** For virtually draft-free ventilation, adjust the sliders of the air vents to the center position.

Setting the center air vents

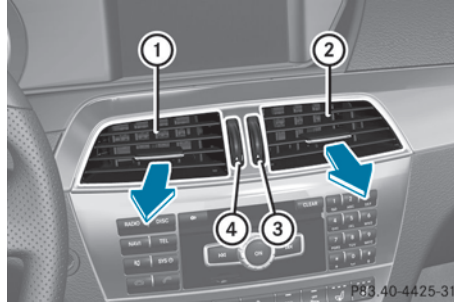

- ① Center air vent, left
- ② Center air vent, right
- ③ Center vent thumbwheel, right
- ④ Center vent thumbwheel, left

- ▶ **To open/close:** turn thumbwheels ③ and ④ up or down.

Setting the side air vents

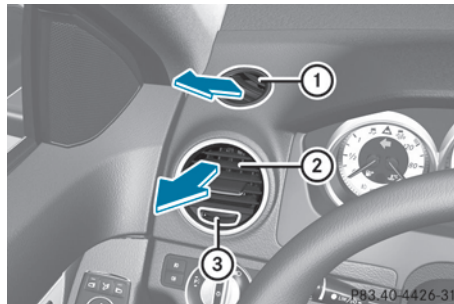

- ① Side window defroster vent
- ② Side air vent
- ③ Control for side air vent

- ▶ **To open/close:** turn thumbwheel ③ to the left or right.

Setting the glove box air vent

When automatic climate control is activated, the glove box can be ventilated, for instance to cool its contents. The level of airflow depends on the airflow and air distribution settings.

! Close the air vent when heating the vehicle.

At high outside temperatures, open the air vent and activate the "cooling with air dehumidification" function. Otherwise, temperature-sensitive items stored in the glove box could be damaged.

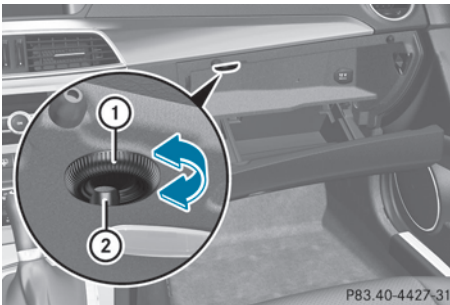

- ① Air vent thumbwheel
- ② Air vent

► **To open/close:** turn thumbwheel ① clockwise or counter-clockwise.

Setting the rear-compartment air vents

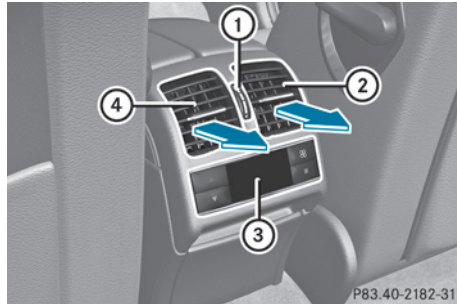

- ① Rear-compartment air vent thumbwheel
- ② Rear-compartment air vent, right
- ③ Rear control unit, only with 3-zone automatic climate control¹⁰
- ④ Rear-compartment air vent, left

► **To open/close:** turn thumbwheel ① up or down.

¹⁰ Only for Canada.

Useful information	146
Notes on breaking-in a new vehicle	146
Driving	146
Automatic transmission	154
Refueling	162
Parking	164
Driving tips	166
Driving systems	171

Useful information

- i** This Operator's Manual describes all models and all standard and optional equipment of your vehicle available at the time of publication of the Operator's Manual. Country-specific differences are possible. Please note that your vehicle may not be equipped with all features described. This also applies to safety-related systems and functions.
- i** Read the information on qualified specialist workshops: (▷ page 25).

Notes on breaking-in a new vehicle

Important safety notes

New and replaced brake pads and discs only reach their optimum braking effect after several hundred kilometers of driving. Compensate for this by applying greater force to the brake pedal.

The first 1000 miles (1500 km)

The more you look after the engine when it is new, the more satisfied you will be with its performance in the future.

- You should therefore drive at varying vehicle and engine speeds for the first 1000 miles (1500 km).
- Ideally, for the first 1,000 miles (1,500 km), drive in program **E** (program **C** on AMG vehicles).
- Avoid heavy loads, e.g. driving at full throttle, during this period.
- Change gear in good time, before the tachometer needle is $\frac{2}{3}$ of the way to the red area of the tachometer.
- Do not manually shift to a lower gear to brake the vehicle.

- If possible, do not depress the accelerator pedal past the point of resistance (kickdown).
- Only select shift ranges **3**, **2** or **1** when driving slowly, e.g. in mountainous terrain. After 1000 miles (1500 km), you can increase the engine speed gradually and accelerate the vehicle to full speed.

Additional breaking-in notes for AMG vehicles:

- Do not drive faster than 85 mph (140 km/h) for the first 1,000 miles (1,500 km).
- Only allow the engine to reach a maximum engine speed of 4,500 rpm briefly.
- Change gear in good time.

i You should also observe these notes on breaking in if the engine or parts of the drive train on your vehicle have been replaced.

i Always observe the respective speed limits.

AMG vehicles with self-locking rear axle differential

Your vehicle is equipped with a self-locking differential on the rear axle. To protect the differential on the rear axle, carry out an oil change after a breaking-in phase of 2,000 miles (3,000 km). This oil change prolongs the service life of the differential. Have the oil change carried out at a qualified specialist workshop.

Driving

Important safety notes

WARNING

Objects in the driver's footwell can restrict the pedal travel or obstruct a depressed pedal. The operating and road safety of the vehicle is jeopardized. There is a risk of an accident.

Make sure that all objects in the vehicle are stowed correctly, and that they cannot enter the driver's footwell. Install the floor mats securely and as specified in order to ensure sufficient clearance for the pedals. Do not use loose floor mats and do not place floor mats on top of one another.

WARNING

Unsuitable footwear can hinder correct usage of the pedals, e.g.:

- shoes with thick soles
- shoes with high heels
- slippers

There is a risk of an accident.

Wear suitable footwear to ensure correct usage of the pedals.

WARNING

If you switch off the ignition while driving, safety-relevant functions are only available with limitations, or not at all. This could affect, for example, the power steering and the brake boosting effect. You will require considerably more effort to steer and brake. There is a risk of an accident.

Do not switch off the ignition while driving.

WARNING

If the parking brake has not been fully released when driving, the parking brake can:

- overheat and cause a fire
- lose its hold function.

There is a risk of fire and an accident. Release the parking brake fully before driving off.

! Warm up the engine quickly. Do not use the engine's full performance until it has reached operating temperature.

Only shift the automatic transmission to the desired drive position when the vehicle is stationary.

Where possible, avoid spinning the drive wheels when pulling away on slippery

roads. You could otherwise damage the drive train.

! **AMG vehicles:** at low engine oil temperatures below 68 °F (+20 °C), the maximum engine speed is restricted in order to protect the engine. To protect the engine and maintain smooth engine operation, avoid driving at full throttle when the engine is cold.

Key positions

SmartKey

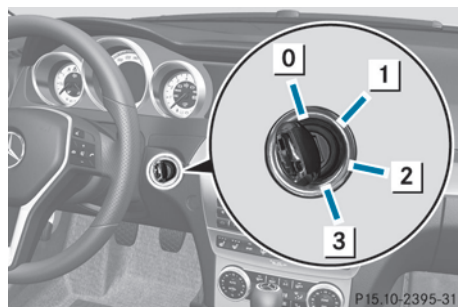

- 0** To remove the SmartKey
Vehicles with automatic transmission: shift the transmission to position **P**
- 1** Power supply for some consumers, such as the windshield wipers
- 2** Ignition (power supply for all consumers) and drive position
- 3** To start the engine

The steering is locked when you remove the SmartKey from the ignition lock.

i The SmartKey can be turned in the ignition lock even if it is not the correct SmartKey for the vehicle. The ignition is not switched on. The engine cannot be started.

KEYLESS-GO

General notes

- Do not keep the KEYLESS-GO key:
 - with electronic devices, e.g. a mobile phone or another SmartKey
 - with metallic objects, e.g. coins or metal foil
 - inside metallic objects, e.g. a metal case

This can impair the functionality of the KEYLESS-GO key.

Vehicles with KEYLESS-GO are equipped with a SmartKey featuring an integrated KEYLESS-GO function and a detachable Start/Stop button.

The Start/Stop button must be inserted in the ignition lock and the SmartKey must be in the vehicle.

Pressing the Start/Stop button several times in succession corresponds to the different key positions in the ignition lock. This is only the case if you are not depressing the brake pedal.

If you depress the brake pedal and press the Start/Stop button, the engine starts immediately.

The Start/Stop button can be removed from the ignition lock. Then, you can insert the SmartKey into the ignition lock.

- ① You do not have to remove the Start/Stop button from the ignition lock when you leave the vehicle. You should, however, always take the SmartKey with you when leaving the vehicle. The vehicle can be started with the Start/Stop button if the SmartKey is in the vehicle.

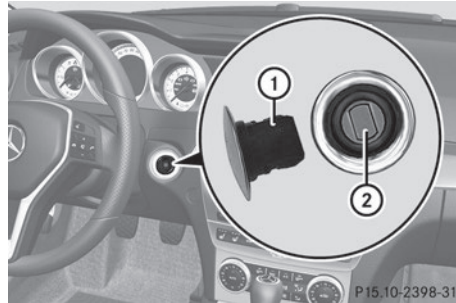

① Start/Stop button

② Ignition lock

- ▶ Insert Start/Stop button ① into ignition lock ②.

- ① When you insert Start/Stop button ① into ignition lock ②, the system needs approximately 2 seconds recognition time. You can then use Start/Stop button ①.

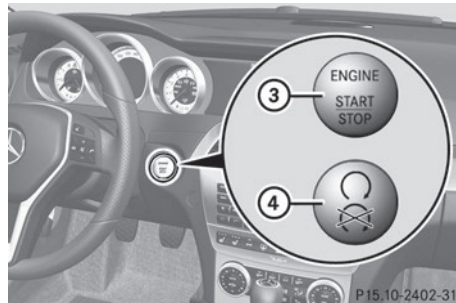

Start/Stop button

③ USA only

④ Canada only

- ▶ Position 0: if Start/Stop button ① has not yet been pressed, this corresponds to the key being removed from the ignition.
- ▶ Position 1: press Start/Stop button ①. You can now activate the windshield wipers, for example.

- ① If you then open the driver's door when in this position, the power supply is deactivated.

- ▶ Position 2: (ignition): press Start/Stop button ① twice.

- i** The power supply is switched off again if:
- the driver's door is opened and
 - you press Start/Stop button **1** once when in this position

As soon as the ignition is switched on, all the indicator lamps in the instrument cluster light up. If an indicator lamp does not go out after starting the engine or lights up while driving, see (▷ page 250).

Starting the engine

Important safety notes

⚠ WARNING

If children are left unsupervised in the vehicle, they could:

- open the doors, thus endangering other people or road users.
- get out and disrupt traffic.
- operate the vehicle's equipment.

Additionally, children could set the vehicle in motion if, for example, they:

- release the parking brake.
- shift the automatic transmission out of parking position **P**.
- starting the engine.

There is a risk of an accident and injury.

When leaving the vehicle, always take the SmartKey with you and lock the vehicle. Never leave children or animals unattended in the vehicle. Always keep the SmartKey out of reach of children.

⚠ WARNING

Combustion engines emit poisonous exhaust gases such as carbon monoxide. Inhaling these exhaust gases leads to poisoning. There is a risk of fatal injury. Therefore never leave the engine running in enclosed spaces without sufficient ventilation.

⚠ WARNING

Flammable materials introduced through environmental influence or by animals can ignite if in contact with the exhaust system or parts of the engine that heat up. There is a risk of fire.

Carry out regular checks to make sure that there are no flammable foreign materials in the engine compartment or in the exhaust system.

- !** Do not depress the accelerator pedal when starting the engine.

General notes

- i** The catalytic converter is preheated for up to 30 seconds after a cold start. The sound of the engine may change during this time.

Automatic transmission

- Shift the transmission to position **P**. The transmission position display in the multifunction display shows **P**.

- i** You can also start the engine when the transmission is in position **N**.

Starting procedure with the SmartKey

- i** To start the engine using the SmartKey instead of KEYLESS-GO, pull the Start/Stop button out of the ignition lock.
- Turn the SmartKey to position **3** in the ignition lock (▷ page 147) and release it as soon as the engine is running.

Using KEYLESS-GO to start the engine

You can start the engine if a valid SmartKey with the integrated KEYLESS-GO function is in the vehicle. Always take the SmartKey with you when leaving the vehicle, even if you only leave it for a short time. Pay attention to the important safety notes.

i The Start/Stop button can be used to start the vehicle without inserting the SmartKey into the ignition lock. The Start/Stop button must be inserted in the ignition lock and the SmartKey must be in the vehicle.

- ▶ Depress the brake pedal and keep it depressed.
- ▶ Press the Start/Stop button once (▷ page 148).
The engine starts.

Pulling away

Automatic transmission

WARNING

If the engine speed is above the idling speed and you engage transmission position **D** or **R**, the vehicle could pull away suddenly. There is a risk of an accident.

When engaging transmission position **D** or **R**, always firmly depress the brake pedal and do not simultaneously accelerate.

i It is only possible to shift the transmission from position **P** to the desired position if you depress the brake pedal. Only then is the selector lever lock released.

- ▶ Depress the brake pedal and keep it depressed.
- ▶ Shift the transmission to position **D** or **R**.
- ▶ Release the parking brake (▷ page 165).
- ▶ Release the brake pedal.
- ▶ Carefully depress the accelerator pedal.

! If a warning tone sounds and the **Release Park. Brake** message appears in the multifunction display, the parking brake is still applied. Release the parking brake.

i The vehicle locks centrally once you have pulled away. The locking knobs in the doors drop down.

You can open the doors from the inside at any time.

You can also deactivate the automatic locking feature (▷ page 217).

i Upshifts take place at higher engine speeds after a cold start. This helps the catalytic converter to reach its operating temperature more quickly.

Hill start assist

Hill start assist helps you when pulling away forwards or in reverse on an uphill gradient. It holds the vehicle for a short time after you have removed your foot from the brake pedal. This gives you enough time to move your foot from the brake pedal to the accelerator pedal and to depress it before the vehicle begins to roll.

WARNING

After a short time, hill start assist will no longer brake your vehicle and it could roll away. There is a risk of an accident and injury. Therefore, quickly move your foot from the brake pedal to the accelerator pedal. Never leave the vehicle when it is held by hill start assist.

- ▶ Take your foot off the brake pedal.
The vehicle is then held for about a second.
- ▶ Pull away.

Hill start assist is not active if:

- you are pulling away on a level road or on a downhill gradient.
- the transmission is in position **N**.
- the parking brake is applied.
- ESP® is malfunctioning.

ECO start/stop function

Introduction

The ECO start/stop function switches the engine off automatically if the vehicle is stopped under certain conditions.

The engine starts automatically when the driver wants to pull away again. The ECO start/stop function thereby helps you to reduce the fuel consumption and emissions of your vehicle.

Important safety notes

WARNING

If the engine is switched off automatically and you exit the vehicle, the engine is restarted automatically. The vehicle may begin moving. There is a risk of accident and injury.

If you wish to exit the vehicle, always turn off the ignition and secure the vehicle against rolling away.

General notes

If the **ECO** symbol is shown in green in the multifunction display, the ECO start/stop function switches the engine off automatically if the vehicle stops moving.

Every time you switch on the engine using the SmartKey or the Start/Stop button, the ECO start/stop function is activated.

If the ECO start/stop function has been manually deactivated (> page 152) or a malfunction has caused the system to be deactivated, the **ECO** symbol is not displayed.

Automatic engine switch-off

General notes

The ECO start/stop function is operational and the **ECO** symbol is displayed in green in the multifunction display, if:

- the indicator lamp in the ECO button is lit green.
- the outside temperature is within the range that is suitable for the system.
- the engine is at normal operating temperature.
- the set temperature for the vehicle interior has been reached.

- the battery is sufficiently charged.
- the system detects that the windshield is not fogged up when the air-conditioning system is switched on.
- the hood is closed.
- the driver's door is closed and the driver's seat belt is fastened.

If not all conditions for automatic engine switch-off are fulfilled, the **ECO** symbol is shown in yellow.

i All of the vehicle's systems remain active when the engine has been stopped automatically.

i The engine can be switched off automatically a maximum of four times (first stop and three subsequent stops) in succession. The **ECO** symbol is shown in yellow in the multifunction display after the engine has been started automatically for the fourth time. When the **ECO** symbol is shown in green in the multifunction display, automatic engine switch-off is again possible.

Vehicles with automatic transmission

If the vehicle is braked to a standstill in **D** or **N**, the ECO start/stop function switches off the engine automatically.

i The HOLD function can be activated if the engine has been switched off automatically. It is then not necessary to continue applying the brakes during the automatic stop phase. When you depress the accelerator pedal, the engine starts automatically and the braking effect of the HOLD function is deactivated.

Automatic engine start

General notes

The engine starts automatically if:

- you switch off the ECO start/stop function by pressing the ECO button.
- you engage reverse gear **R**.
- the vehicle starts to roll.

- the brake system requires this.
- the temperature in the vehicle interior deviates from the set range.
- the system detects moisture on the windshield when the air-conditioning system is switched on.
- the condition of charge of the battery is too low.
- the driver's seat belt is removed or the driver's door is opened.

Vehicles with automatic transmission

The engine is started automatically if you:

- release the brake pedal when HOLD is not activated and the transmission is in position **D** or **N**.
- depress the accelerator pedal.
- move the transmission out of position **P**.

- i** Shifting the transmission to position **P** does not start the engine.
- i** If you shift the transmission from **R** to **D**, the ECO start/stop function is available again once the **ECO** symbol reappears in green in the multifunction display.

Deactivating/activating the ECO start/stop function



ECO button

- **To switch off:** press button ①. Indicator lamp ② on button ① and the **ECO** symbol in the multifunction display go out.

- **To switch on:** press button ①. Indicator lamp ② lights up.

If all conditions for automatic engine switch-off (▷ page 151) are fulfilled, the **ECO** symbol is shown in green in the multifunction display.

If not all conditions for automatic engine switch-off (▷ page 151) are fulfilled, the **ECO** symbol is shown in yellow in the multifunction display. If this is the case, the ECO start/stop function is not available.

- i** If indicator lamp ② is off, the ECO start/stop function has been deactivated manually or as the result of a malfunction. The engine will then not be switched off automatically when the vehicle stops.

Problems with the engine

Problem	Possible causes/consequences and ► Solutions
<p>The engine does not start. The starter motor can be heard.</p>	<ul style="list-style-type: none"> • There is a malfunction in the engine electronics. • There is a malfunction in the fuel supply. <p>► Turn the SmartKey back to position 0 in the ignition lock before attempting to start the engine again.</p> <p>or</p> <p>► Press the Start/Stop button repeatedly until all indicator lamps in the instrument cluster go out.</p> <p>► Try to start the engine again (▷ page 149). Avoid excessively long and frequent attempts to start the engine as these will drain the battery.</p> <p>If the engine does not start after several attempts:</p> <p>► Consult a qualified specialist workshop.</p>
<p>The engine does not start. You cannot hear the starter motor.</p>	<p>The on-board voltage is too low because the battery is too weak or discharged.</p> <p>► Jump-start the vehicle (▷ page 306).</p> <p>If the engine does not start despite attempts to jump-start it:</p> <p>► Consult a qualified specialist workshop.</p> <hr/> <p>The starter motor was exposed to a thermal load that was too high.</p> <p>► Allow the starter motor to cool down for approximately two minutes.</p> <p>► Try to start the engine again.</p> <p>If the engine still does not start:</p> <p>► Consult a qualified specialist workshop.</p>

Problem	Possible causes/consequences and ► Solutions
The engine is not running smoothly and is misfiring.	<p>There is a malfunction in the engine electronics or in a mechanical component of the engine management system.</p> <ul style="list-style-type: none"> ► Only depress the accelerator pedal slightly. ► Have the cause rectified immediately at a qualified specialist workshop. <p>Otherwise, non-combusted fuel may get into the catalytic converter and damage it.</p>
The coolant temperature gauge shows a value above 248 °F (120 °C).	<p>The coolant level is too low. The coolant is too hot and the engine is no longer being cooled sufficiently.</p> <ul style="list-style-type: none"> ► Stop as soon as possible and allow the engine and the coolant to cool down. ► Check the coolant level (> page 290). Observe the warning notes as you do so and add coolant if necessary.

Automatic transmission

Important safety notes

WARNING

If the engine speed is above the idling speed and you engage transmission position **D** or **R**, the vehicle could pull away suddenly. There is a risk of an accident.

When engaging transmission position **D** or **R**, always firmly depress the brake pedal and do not simultaneously accelerate.

WARNING

The automatic transmission switches to neutral position **N** when you switch off the engine. The vehicle may roll away. There is a risk of an accident.





After switching off the engine, always switch to parking position **P**. Prevent the parked vehicle from rolling away by applying the parking brake.

Selector lever

Overview of transmission positions



Example: selector lever

-  Park position with selector lever lock
-  Reverse gear
-  Neutral
-  Drive

Transmission position and drive program display



- ① Transmission position display
- ② Drive program display

The current position of the selector lever is shown by the indicators next to the selector lever.

The indicators light up when the SmartKey is inserted into the ignition lock. The indicators go out when the SmartKey is removed from the ignition lock.

Transmission positions

P

Park position

Do not shift the transmission into position **P** (▷ page 164) unless the vehicle is stationary. The parking lock should not be used as a brake when parking. Always apply the parking brake in addition to the parking lock in order to secure the vehicle.

The SmartKey can only be removed if the transmission is in position **P**. If the SmartKey is removed from the ignition lock, the selector lever is locked.

If the vehicle electronics are malfunctioning, the selector lever may be locked in position **P**. To release a locked selector lever, see "Manual override of parking lock" (▷ page 161).

R

Reverse gear

Only shift the transmission to **R** when the vehicle is stationary.

N**Neutral**

Do not shift the transmission to **N** while driving. The transmission could otherwise be damaged.

No power is transmitted from the engine to the drive wheels.

Releasing the brakes will allow you to move the vehicle freely, e.g. to push it or tow it.

If ESP® is deactivated or faulty: only shift the transmission to position **N** if the vehicle is in danger of skidding, e.g. on icy roads.

! Rolling in neutral **N** can damage the drive train.

D**Drive**

The automatic transmission changes gear automatically. All forward gears are available.

Changing gear

The automatic transmission shifts to the individual gears automatically when it is in transmission position **D**. This automatic gearshifting behavior is determined by:

- a shift range restriction, if selected
- the selected drive program (▷ page 156)
- the position of the accelerator pedal
- the road speed

Driving tips**AMG vehicles**

When shifting down, the double-clutch function is active regardless of the currently selected drive program. The double-clutch function reduces load change reactions and is conducive to a sporty driving style. The sound generated by the double-clutch function depends on the drive program selected.

Kickdown

Use kickdown for maximum acceleration.

- ▶ Depress the accelerator pedal beyond the pressure point.
The automatic transmission shifts to a lower gear depending on the engine speed.
- ▶ Ease off the accelerator pedal once the desired speed is reached.
The automatic transmission shifts back up.

Program selector button**General notes**

The program selector button allows you to choose between different driving characteristics.

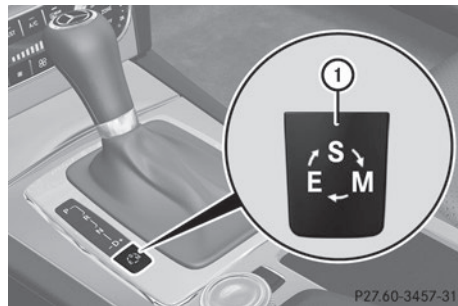

Example: program selector button

E Economy	Comfortable, economical driving
S Sport	Sporty driving style
M Manual	Manual gear shifting

i For further information on the automatic drive program, see (▷ page 157).

Only change from automatic drive program **E** or **S** to manual drive program **M** when the vehicle is stationary.

- ▶ Press program selector button ① repeatedly until the letter for the desired drive program appears in the multifunction display.

- i** When the engine is started, the automatic transmission always switches to automatic drive program **E** (drive program **C** in AMG vehicles).

AMG vehicles



Drive program selector with manual drive program

C Controlled Efficiency	Comfortable, economical driving
S Sport	Sporty driving style
S+ SportPlus	Extremely sporty driving style
M Manual	Manual gear shifting
RS RACE START	Optimal vehicle acceleration from a standstill

- i** For further information on the automatic drive program, see (> page 157).

Only change from automatic drive program **C**, **S** or **S+** to manual drive program **M** when the vehicle is stationary.

- ▶ Turn drive program selector ① until the desired drive program appears in the multifunction display in the speedometer. The drive program indicator on drive program selector ① lights up in red.

- i** The automatic transmission shifts to automatic drive program **C** each time the engine is started.

- i** **RS** cannot be selected during normal driving. For further information on RACE START, see (> page 183).

Steering wheel paddle shifters

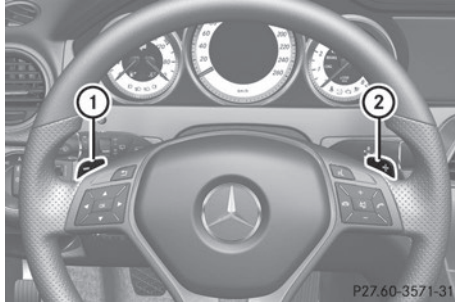

- ① Left-hand steering wheel paddle shifter
- ② Right-hand steering wheel paddle shifter

In the automatic drive program, you can restrict or derestrict the shift range by using the steering wheel paddle shifters (> page 158).

In the manual drive program, you can change gear using the steering wheel paddle shifters or the selector lever (> page 159).

- i** You can only change gear with the steering wheel paddle shifters when the transmission is in position **D**.

Automatic drive program

Drive program **E** (drive program **C** on MAG vehicles) is characterized by the following:

- comfort-oriented engine and automatic transmission settings
- optimal fuel consumption resulting from the automatic transmission shifting up sooner
- the vehicle pulling away more gently in forward and reverse gears, unless the accelerator pedal is depressed fully

- increased sensitivity. This improves driving stability on slippery road surfaces, for example
- the automatic transmission shifting up sooner. This results in the vehicle being driven at lower engine speeds and the wheels being less likely to spin

Drive program **S** (drive programs **S** and **S+** on MAG vehicles) is characterized by the following:

- sporty engine and automatic transmission settings
- the vehicle pulling away in first gear
- the automatic transmission shifting up later
- the fuel consumption possibly being higher as a result of the later automatic transmission shift points

Shift ranges

Introduction

When the automatic transmission is in position **D**, it is possible to restrict or derestrict the shift range (▷ page 158).

The shift range selected is shown in the multifunction display. The automatic transmission shifts only as far as the selected gear.

Shift range:

3	You can use the engine's braking effect
2	You can use the braking effect of the engine on downhill gradients and for driving: <ul style="list-style-type: none"> • on steep mountain roads • in mountainous terrain • in arduous conditions
1	To use the braking effect of the engine on extremely steep downhill gradients and on long downhill stretches

Restricting the shift range

- ▶ Press the selector lever to the left towards **D-**.

or

- ▶ Pull the left-hand steering wheel paddle shifter.

The automatic transmission shifts down one gear and restricts the shift range to the relevant gear.

- i** If the engine exceeds the maximum engine speed when shifting down, the automatic transmission protects against engine damage by not shifting down.
- i** If the maximum engine speed for the shift range is reached and you continue to accelerate, the automatic transmission shifts up, even if the shift range is restricted. This prevents the engine from overrevving.

Extending the shift range

- ▶ Briefly press the selector lever to the right towards **D+**.

or

- ▶ Pull the right-hand steering wheel paddle shifter.

The shift range is derestricted.

Clearing the shift range restriction

- ▶ Press and hold the selector lever towards **D+** until **D** is shown once more in the multifunction display.

or

- ▶ Pull and hold the right-hand steering wheel paddle shifter until **D** is shown again in the multifunction display.

The automatic transmission shifts from the current shift range directly to **D**.

Selecting the ideal shift range

- ▶ Press the selector lever to the left towards **D-** and hold it in position.

or

- ▶ Pull the left-hand steering wheel paddle shifter and hold it in position.
The automatic transmission shifts to the gear which allows optimum acceleration and deceleration. To do this, the automatic transmission shifts down one or more gears.

Manual drive program

Switching on the manual drive program

The manual drive program is only available for vehicles with the dynamic handling package and for AMG vehicles.

Manual drive program **M** differs from drive program **S** (or, in the case of AMG vehicles, drive programs **S** and **S+**) with regard to:

- spontaneity
- responsiveness
- smoothness of the gear changes
- ▶ Press the program selector button (▷ page 156) repeatedly until **M** appears in the multifunction display.
- ▶ **AMG vehicles:** turn the drive program selector (▷ page 157) until **M** appears in the multifunction display.
The indicator **M** on the drive program selector lights up in red.

Upshifting

- i Vehicles with the dynamic handling package:** if the maximum engine speed for the shift range is reached and you continue to accelerate, the automatic transmission shifts up. If manual drive program **M** has been selected, the automatic transmission does not switch up.

- ▶ Briefly press the selector lever to the right towards **D+**.

or

- ▶ Pull the right-hand steering wheel paddle shifter (▷ page 157).
The automatic transmission shifts up to the next gear.

AMG vehicles

- !** In manual drive program **M**, the automatic transmission does not shift up automatically even when the engine limiting speed for the current gear is reached. When the engine limiting speed is reached, the fuel supply is cut to prevent the engine from overrevving. Always make sure that the engine speed does not reach the red area of the tachometer. There is otherwise a risk of engine damage.

Before the engine speed reaches the red area, an upshift indicator appears in the multifunction display.



- ① Gear indicator
- ② Upshift indicator

Shift recommendation



The gearshift recommendations assist you in adopting an economical driving style. The recommended gear is shown in the multifunction display.

- ▶ If corresponding gearshift recommendation ① appears in the multifunction display on the instrument cluster, pull on the right-hand steering wheel paddle shifter (▷ page 157). The automatic transmission shifts to recommended gear ②.

Downshifting

- ▶ Briefly press the selector lever to the left towards **D-**.

or

- ▶ Pull the left-hand steering wheel paddle shifter (▷ page 157). The automatic transmission shifts down to the next gear.

i If you brake the vehicle or stop without shifting down, the automatic transmission will shift down to a gear that will allow the vehicle to accelerate or pull away again.

i **Vehicles with the dynamic handling package:** to avoid overrevving the engine when downshifting, the automatic transmission does not shift to a lower gear if this would result in the maximum engine speed being exceeded.

i For maximum acceleration, push the selector lever to the left or pull the left-hand steering wheel paddle shifter until the transmission selects the optimum gear for the current speed.

Kickdown

i **AMG vehicles:** it is not possible to use kickdown in manual drive program **M**.

You can also use kickdown for maximum acceleration in manual drive program **M**.

- ▶ Depress the accelerator pedal beyond the pressure point. The automatic transmission shifts to a lower gear depending on the engine speed.

i During kickdown, you cannot change gear using the steering wheel paddle shifters or the selector lever.

Switching off the manual drive program

▶ **Vehicles with the dynamic handling package:** press the program selector button (▷ page 156). **M** is no longer shown in the multifunction display.

▶ **AMG vehicles:** turn the drive program selector (▷ page 157) until **C**, **S** or **S+** appears in the multifunction display.

Problems with the transmission

Problem	Possible causes/consequences and ► Solutions
The transmission has problems shifting gear.	The transmission is losing oil. ► Have the transmission checked at a qualified specialist workshop immediately.
The acceleration ability is deteriorating. The transmission no longer changes gear.	The transmission is in emergency mode. It is only possible to shift into second gear and reverse gear. ► Stop the vehicle. ► Shift the transmission to position P . ► Switch off the engine. ► Wait at least ten seconds before restarting the engine. ► Shift the transmission to position D or R . If D is selected, the transmission shifts into second gear; if R is selected, the transmission shifts into reverse gear. ► Have the transmission checked at a qualified specialist workshop immediately.

Releasing the parking lock manually

In the event of an electrical malfunction, it is possible to release the selector lever lock manually to move it out of position **P**. This is the case, for example, if you wish to tow the vehicle away.

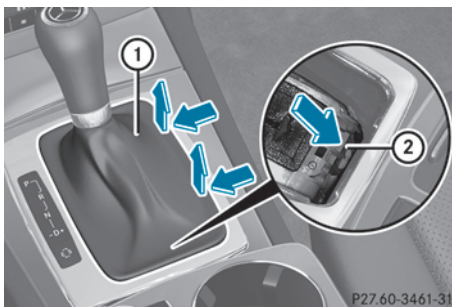

❗ Do not use any sharp-edged objects to remove the selector lever gaiter from the center console. This could damage the selector lever gaiter.

- Apply the parking brake.
- Pry off selector lever gaiter ① with a flat, blunt object (e.g. a screwdriver wrapped in

cloth) from the right-hand edge. Pull selector lever gaiter ① up and out.

- Press release button ② down and simultaneously move the selector lever out of position **P**.

The selector lever can now be moved freely until it is returned to position **P**.

Transfer case

This section is only valid for vehicles with 4-wheel drive (4MATIC). Power is always transmitted to both axles.

❗ Performance tests may only be carried out on a 2-axle dynamometer. The brake system or transfer case could otherwise be damaged. Contact a qualified specialist workshop for a performance test.

❗ If the parking brake is being tested on a brake dynamometer, the ignition must be switched off (SmartKey or Start/Stop button in position **0** or **1**), as ESP® will

otherwise automatically intervene. The brake system could otherwise be damaged.

- ❗ Vehicles with 4MATIC must not be towed with either the front or the rear axle raised, as doing so will damage the transmission.

Refueling

Important safety notes

⚠️ WARNING

Fuel is highly flammable. If you handle fuel incorrectly, there is a risk of fire and explosion.

You must avoid fire, open flames, creating sparks and smoking. Switch off the engine and, if applicable, the auxiliary heating before refueling.

⚠️ WARNING

Fuel is poisonous and hazardous to health. There is a risk of injury.

You must make sure that fuel does not come into contact with your skin, eyes or clothing and that it is not swallowed. Do not inhale fuel vapors. Keep fuel away from children.

If you or others come into contact with fuel, observe the following:

- Wash away fuel from skin immediately using soap and water.
- If fuel comes into contact with your eyes, immediately rinse them thoroughly with clean water. Seek medical assistance without delay.
- If fuel is swallowed, seek medical assistance without delay. Do not induce vomiting.
- Immediately change out of clothing which has come into contact with fuel.

⚠️ WARNING

Electrostatic buildup can create sparks and ignite fuel vapors. There is a risk of fire and explosion.

Always touch the vehicle body before opening the fuel filler flap or touching the fuel pump nozzle. Any existing electrostatic buildup is thereby discharged.

- ❗ Overfilling the fuel tank could damage the fuel system.
- ❗ Take care not to spill any fuel on painted surfaces. You could otherwise damage the paintwork.
- ❗ Use a filter when refueling from a fuel can. Otherwise, the fuel lines and/or injection system could be blocked by particles from the fuel can.

Do not get into the vehicle again during the refueling process. Otherwise, electrostatic charge could build up again.

If you overfill the fuel tank, fuel could spray out when the fuel pump nozzle is removed.

For further information on fuel and fuel quality (> page 351).

Refueling

Opening/closing the fuel filler flap

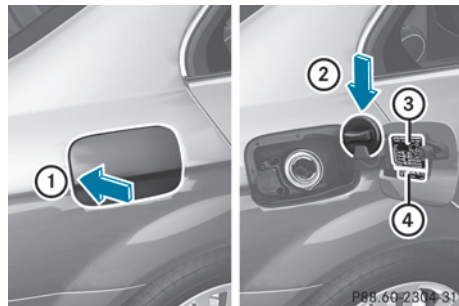

- ① To open the fuel filler flap
- ② To insert the fuel filler cap
- ③ Tire pressure table
- ④ Fuel type to be used



The fuel filler flap is unlocked or locked automatically when you open or close the vehicle with the SmartKey or with KEYLESS-GO.

The position of the fuel filler cap is displayed  in the instrument cluster. The arrow next to the filling pump indicates the side of the vehicle.

To open

- ▶ Switch the engine off.
- ▶ Remove the SmartKey from the ignition lock.
- ▶ KEYLESS-GO: open the driver's door. This corresponds to key position **0**: "key removed". The driver's door can be closed again.
- ▶ Press the fuel filler flap in the direction of arrow ①. The fuel filler flap opens slightly.
- ▶ Open the fuel filler flap fully.
- ▶ Turn the fuel filler flap counter-clockwise and remove it.
- ▶ Insert the fuel filler cap into the holder bracket on the inside of filler flap ②.
- ▶ Completely insert the filler neck of the fuel pump nozzle into the tank, hook in place and refuel.
- ▶ Only fill the tank until the pump nozzle switches off.
- i** Do not add any more fuel after the pump stops filling for the first time. Otherwise, fuel may leak out.

To close

- ▶ Replace the cap on the filler neck and turn clockwise until it engages audibly.
- ▶ Close the fuel filler flap.
- i** Close the fuel filler flap before locking the vehicle.
- i** If you are driving with the fuel filler cap open, the  reserve fuel warning lamp flashes. A message appears in the multifunction display (▷ page 236). In addition, the  Check Engine warning lamp may light up (▷ page 256).

For further information on warning and indicator lamps in the instrument cluster, see (▷ page 256).

Fuel filler flap emergency release

- ▶ Open the trunk lid.

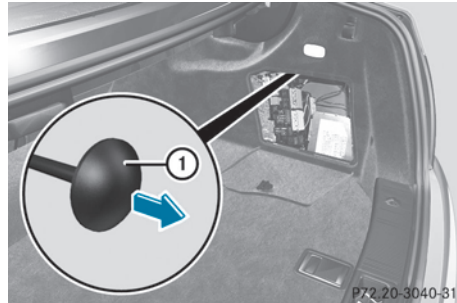

- ▶ Open the right-hand side trim panel (▷ page 312).
- ▶ Pull emergency release ① in the direction of the arrow. The fuel filler flap is unlocked.
- ▶ Open the fuel filler flap.

Problems with fuel and the fuel tank

Problem	Possible causes/consequences and ► Solutions
Fuel is leaking from the vehicle.	<p>The fuel line or the fuel tank is faulty.</p> <p> WARNING</p> <p>Risk of explosion or fire.</p> <ul style="list-style-type: none"> ► Turn the SmartKey to position 0 in the ignition lock and remove it immediately (▷ page 147). ► Do not restart the engine under any circumstances. ► Consult a qualified specialist workshop.
The fuel filler flap cannot be opened.	<p>The fuel filler flap is not unlocked.</p> <p>or</p> <p>The SmartKey battery is discharged.</p> <ul style="list-style-type: none"> ► Unlock the vehicle using the mechanical key (▷ page 78). ► Open the trunk lid. ► Manually unlock the fuel filler flap using the emergency release (▷ page 163). <p>The fuel filler flap is unlocked, but the opening mechanism is jammed.</p> <ul style="list-style-type: none"> ► Consult a qualified specialist workshop.

Parking

Important safety notes

 **WARNING**

Flammable material such as leaves, grass or twigs may ignite if they come into contact with hot parts of the exhaust system or exhaust gas flow. There is a risk of fire.

Park the vehicle so that no flammable materials come into contact with parts of the vehicle which are hot. Take particular care not to park on dry grassland or harvested grain fields.

 **WARNING**

If you switch off the ignition while driving, safety-relevant functions are only available with limitations, or not at all. This could affect, for example, the power steering and the brake

boosting effect. You will require considerably more effort to steer and brake. There is a risk of an accident.

Do not switch off the ignition while driving.

 **WARNING**

If you leave children unsupervised in the vehicle, they could set it in motion by, for example:

- release the parking brake.
- shift the automatic transmission out of the parking position **P**.
- start the engine.

In addition, they may operate vehicle equipment and become trapped. There is a risk of an accident and injury.

When leaving the vehicle, always take the SmartKey with you and lock the vehicle. Never leave children unsupervised in the vehicle.

- ❗ Always secure the vehicle correctly against rolling away. Otherwise, the vehicle or its drivetrain could be damaged.

To ensure that the vehicle is secured against rolling away unintentionally:

- the parking brake must be applied.
- the transmission must be in position **P** and the SmartKey must be removed from the ignition lock.
- on uphill or downhill gradients, the front wheels must be turned towards the curb.

Switching off the engine

Important safety notes

WARNING

The automatic transmission switches to neutral position **N** when you switch off the engine. The vehicle may roll away. There is a risk of an accident.

After switching off the engine, always switch to parking position **P**. Prevent the parked vehicle from rolling away by applying the parking brake.

Vehicles with automatic transmission

- ▶ Apply the parking brake firmly.
- ▶ Shift the transmission to position **P**.

Using the SmartKey

- ▶ Turn the SmartKey to position **0** in the ignition lock and remove it.
The immobilizer is activated.
- ❗ The SmartKey can only be removed if the transmission is in position **P**.

Using KEYLESS-GO

- ▶ Press the Start/Stop button (▷ page 148).
The engine stops and all the indicator lamps in the instrument cluster go out.
- ❗ When the driver's door is closed, this corresponds to key position **1**. When the

driver's door is open, this corresponds to key position **0**: "key removed".

If you try to switch off the engine when the transmission is not in position **P**, a message appears in the multifunction display. A signal sounds.

Parking brake

WARNING

If you must brake the vehicle with the parking brake, the braking distance is considerably longer and the wheels could lock. There is an increased danger of skidding and accidents.

Only use the parking brake to brake the vehicle when the service brake is faulty. Do not apply the parking brake too firmly. If the wheels lock, release the parking brake until the wheels begin turning again.

WARNING

If you leave children unsupervised in the vehicle, they could set it in motion by, for example:

- releasing the parking brake
- shifting the automatic transmission out of the parking position **P**
- starting the engine.

They could also operate the vehicle's equipment. There is a risk of an accident and injury.

When leaving the vehicle, always take the SmartKey with you and lock the vehicle. Never leave children unsupervised in the vehicle.

If you brake the vehicle with the parking brake, the brake lamps will not light up.

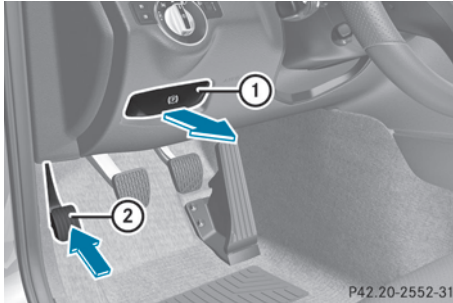

- ▶ **To apply:** depress parking brake ② firmly. When the engine is running, the **BRAKE** (USA only) or **(P)** (Canada only) indicator lamp lights up in the instrument cluster.
- ▶ **To release:** depress the brake pedal and keep it depressed.
- ▶ Pull release handle ①. When the ignition is switched on or the engine is running, the **BRAKE** (USA only) or **(P)** (Canada only) indicator lamp goes out in the instrument cluster.

Parking the vehicle for a long period

If you leave the vehicle parked for longer than four weeks, the battery may be damaged by exhaustive discharging.

- ▶ Connecting a trickle charger.
 - ▶ **i** You can obtain information about trickle chargers from a qualified specialist workshop.
- If you leave the vehicle parked for longer than six weeks, the vehicle may suffer damage as a result of lack of use.
- ▶ Visit a qualified specialist workshop and seek advice.

Driving tips

General driving tips

Important safety notes

⚠ WARNING

If you switch off the ignition while driving, safety-relevant functions are only available with limitations, or not at all. This could affect, for example, the power steering and the brake boosting effect. You will require considerably more effort to steer and brake. There is a risk of an accident.

Do not switch off the ignition while driving.

⚠ WARNING

If you operate mobile communication equipment while driving, you will be distracted from traffic conditions. You could also lose control of the vehicle. There is a risk of an accident.

Only operate this equipment when the vehicle is stationary.

Observe the legal requirements for the country in which you are driving. Some jurisdictions prohibit the driver from using a mobile phone while driving a vehicle.

If you make a call while driving, always use hands-free mode. Only operate the telephone when the traffic situation permits. If you are unsure, pull over to a safe location and stop before operating the telephone.

Bear in mind that at a speed of only 30 mph (approximately 50 km/h), the vehicle covers a distance of 44 ft (approximately 14 m) per second.

Drive sensibly – save fuel

Observe the following tips to save fuel:

- ▶ The tires should always be inflated to the recommended tire pressure.
- ▶ Remove unnecessary loads.
- ▶ Remove roof racks when they are not needed.

- ▶ Warm up the engine at low engine speeds.
- ▶ Avoid frequent acceleration or braking.
- ▶ Have all maintenance work carried out as indicated by the service intervals in the Maintenance Booklet or by the service interval display.

Fuel consumption also increases when driving in cold weather, in stop-start traffic and in hilly terrain.

Drinking and driving

WARNING

Drinking and driving and/or taking drugs and driving are very dangerous combinations. Even a small amount of alcohol or drugs can affect your reflexes, perceptions and judgment.

The possibility of a serious or even fatal accident is greatly increased when you drink or take drugs and drive.

Do not drink or take drugs and drive or allow anyone to drive who has been drinking or taking drugs.

Emission control

WARNING

Combustion engines emit poisonous exhaust gases such as carbon monoxide. Inhaling these exhaust gases leads to poisoning. There is a risk of fatal injury. Therefore never leave the engine running in enclosed spaces without sufficient ventilation.

Certain engine systems are designed to keep the level of poisonous components in exhaust fumes within legal limits.

These systems only work at peak efficiency if they are serviced exactly in accordance with the manufacturer's specifications. For this reason, all work on the engine must be carried out by qualified and authorized Mercedes-Benz technicians.

The engine settings must not be changed under any circumstances. Furthermore, all

specific service work must be carried out at regular intervals and in accordance with the Mercedes-Benz service requirements. Details can be found in the Maintenance Booklet.

ECO display

The ECO display gives you information on how economical your driving style is. The ECO display assists you in achieving the optimum driving style in terms of consumption, taking the actual and selected conditions into consideration. Your driving style can significantly influence the vehicle's consumption.

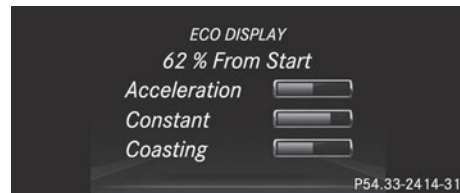

Example: ECO display

The ECO display consists of three bars:

- Acceleration
- Constant
- Coasting

The percent value is the average value of the three bars. The three bars and the mean value begin at the value of 50%. A higher percentage indicates a more economical driving style.

The ECO display does not indicate the actual fuel consumption and a fixed percentage count in the ECO display does not indicate a fixed consumption figure.

Apart from driving style, consumption is dependent on many factors such as, e.g.:

- load
- tire pressure
- cold start
- choice of route
- electrical consumers switched on

These factors are not taken into consideration by the ECO display.

The evaluation of your driving style is carried out using the following three categories:

- **Acceleration** (evaluation of all acceleration processes):
 - The bar fills up: moderate acceleration, especially at higher speeds
 - The bar empties: sporty acceleration
- **Constant** (assessment of driving behavior at all times):
 - The bar fills up: constant speed and avoidance of unnecessary acceleration and deceleration
 - The bar empties: fluctuations in speed
- **Coasting** (assessment of all deceleration processes):
 - The bar fills up: anticipatory driving, keeping your distance and early release of the accelerator. The vehicle can coast without use of the brakes.
 - The bar empties: frequent braking

i An economical driving style specially requires driving at moderate engine speeds.

To achieve a higher value in the categories **Acceleration** and **Constant**:

- observe the gearshift recommendations.
- drive in drive program **E**.

i On long journeys at a constant speed, e.g. on the highway, only the bar for **Constant** will change.

i The ECO display summaries the driving characteristics from the start of the journey to its completion. For this reason, the bars change dynamically at the beginning of the journey. On longer journeys, there are fewer changes. For more dynamic changes, carry out a manual reset.

Further information on the ECO display (▷ page 208).

Braking

Important safety notes

WARNING

If you shift down on a slippery road surface in an attempt to increase the engine's braking effect, the drive wheels could lose their grip. There is an increased danger of skidding and accidents.

Do not shift down for additional engine braking on a slippery road surface.

Downhill gradients

i On long and steep gradients, you must reduce the load on the brakes by shifting early to a lower gear. This allows you to take advantage of the engine braking effect and helps avoid overheating and excessive wear of the brakes.

When you take advantage of the engine braking effect, a drive wheel may not turn for some time, e.g. on a slippery road surface. This could cause damage to the drive train. This type of damage is not covered by the Mercedes-Benz warranty.

Heavy and light loads

WARNING

If you rest your foot on the brake pedal while driving, the braking system can overheat. This increases the stopping distance and can even cause the braking system to fail. There is a risk of an accident.

Never use the brake pedal as a footrest. Never depress the brake pedal and the accelerator pedal at the same time.

i Depressing the brake pedal constantly results in excessive and premature wear to the brake pads.

If the brakes have been subjected to a heavy load, do not stop the vehicle immediately. Drive on for a short while. This allows the airflow to cool the brakes more quickly.

Wet roads

If you have driven for a long time in heavy rain without braking, there may be a delayed reaction from the brakes when braking for the first time. This may also occur after the vehicle has been washed.

You have to depress the brake pedal more firmly. Maintain a greater distance from the vehicle in front.

After driving on a wet road or having the vehicle washed, brake firmly while paying attention to the traffic conditions. This will warm up the brake discs, thereby drying them more quickly and protecting them against corrosion.

Limited braking performance on salt-treated roads

If you drive on salted roads, a layer of salt residue may form on the brake discs and brake pads. This can result in a significantly longer braking distance.

- Brake occasionally to remove any possible salt residue. Make sure that you do not endanger other road users when doing so.
- Carefully depress the brake pedal at the beginning and end of a journey.
- Maintain a greater distance to the vehicle ahead.

Servicing the brakes

! If the red brake warning lamp lights up in the instrument cluster and you hear a warning tone while the engine is running, the brake fluid level may be too low. Observe additional warning messages in the multifunction display.

The brake fluid level may be too low due to brake pad wear or leaking brake lines.

Have the brake system checked immediately. This work should be carried out at a qualified specialist workshop.

All checks and maintenance work on the brake system must be carried out at a

qualified specialist workshop. Consult a qualified specialist workshop to arrange this. Have brake pads installed and brake fluid replaced at a qualified specialist workshop.

! **Vehicles with 4MATIC:** function or performance tests may only be carried out on a 2-axle dynamometer. If you are planning to have the vehicle tested on such a dynamometer, contact an authorized Mercedes-Benz Center to obtain further information first. Otherwise, you could damage the drive train or the brake system.

! **Vehicles with 4MATIC:** as the ESP[®] system operates automatically, the engine and the ignition must be switched off (SmartKey in position **0** or **1** in the ignition lock or Start/Stop button in position **0** or **1**) while the parking brake is being tested on a brake dynamometer.

Braking maneuvers triggered automatically by ESP[®] may seriously damage the brake system.

! **Vehicles with 4MATIC:** as the ESP[®] system operates automatically, the engine and the ignition system must be switched off (SmartKey in position **0** or **1** in the ignition lock or Start/Stop button in position **0** or **1**) when:

- testing the parking brake on a brake dynamometer.
- you intend to have the vehicle towed with the front axle raised.

Braking maneuvers triggered automatically by ESP[®] may seriously damage the brake system.

If the brake system has only been subject to moderate loads, you should test the functionality of your brakes at regular intervals. To do so, press firmly on the brake pedal when driving at a high speed. This improves the grip of the brake pads.

You can find a description of Brake Assist (BAS) on (▷ page 66) or of BAS PLUS on (▷ page 66).

Mercedes-Benz recommends that you only have brake pads/linings installed on your vehicle which have been approved for Mercedes-Benz vehicles or which correspond to an equivalent quality standard. Brake pads/linings which have not been approved for Mercedes-Benz vehicles or which are not of an equivalent quality could affect your vehicle's operating safety.

Mercedes-Benz recommends that you only use brake fluid that has been specially approved for your vehicle by Mercedes-Benz, or which corresponds to an equivalent quality standard. Brake fluid which has not been approved for Mercedes-Benz vehicles or which is not of an equivalent quality could affect your vehicle's operating safety.

High-performance brake system for AMG vehicles

The high-performance brake system is installed only on the C 63 AMG.

The high-performance brake system is designed for heavy loads. This may lead to noise when braking. This will depend on:

- Speed
- Braking force
- Environmental conditions, such as temperature and humidity

The wear and tear on individual brake system components, e.g. brake pads/linings or discs, depends on:

- the individual driving style
- the operating conditions

For this reason, it is impossible to state a mileage that will be valid under all circumstances. An aggressive driving style will lead to high wear. You can obtain further information about this from your authorized Mercedes-Benz Center.

New and replaced brake pads and discs only reach their optimum braking effect after several hundred kilometers of driving. Compensate for this by applying greater force to the brake pedal. Keep this in mind, and

adapt your driving and braking accordingly during this break-in period.

Excessive heavy braking results in correspondingly high brake wear. Observe the brake wear warning lamp in the instrument cluster and note any brake status messages in the multifunction display. Especially for high performance driving, it is important to maintain and have the brake system checked regularly.

Driving on wet roads

Hydroplaning

If water has accumulated to a certain depth on the road surface, there is a danger of hydroplaning occurring, even if:

- you drive at low speeds.
- the tires have adequate tread depth.

For this reason, in the event of heavy rain or in conditions in which hydroplaning may occur, you must drive in the following manner:

- lower your speed.
- avoid ruts.
- brake carefully.

Driving on flooded roads

! Do not drive through flooded areas. Check the depth of any water before driving through it. Drive slowly through standing water. Otherwise, water may enter the vehicle interior or the engine compartment. This can damage the electronic components in the engine or the automatic transmission. Water can also be drawn in by the engine's air suction nozzles and this can cause engine damage.

Winter driving

Important safety notes

WARNING

If you shift down on a slippery road surface in an attempt to increase the engine's braking effect, the drive wheels could lose their grip. There is an increased danger of skidding and accidents.

Do not shift down for additional engine braking on a slippery road surface.

DANGER

If the exhaust pipe is blocked or adequate ventilation is not possible, poisonous gases such as carbon monoxide (CO) may enter the vehicle. This is the case, e.g. if the vehicle becomes trapped in snow. There is a risk of fatal injury.

If you leave the engine or the auxiliary heating running, make sure the exhaust pipe and area around the vehicle are clear of snow. To ensure an adequate supply of fresh air, open a window on the side of the vehicle that is not facing into the wind.

Have your vehicle winterproofed at a qualified specialist workshop at the onset of winter.

Observe the notes in the "Winter operation" section (▷ page 316).

Driving with summer tires

Observe the notes in the "Winter operation" section (▷ page 316).

Slippery road surfaces

WARNING

If you shift down on a slippery road surface in an attempt to increase the engine's braking effect, the drive wheels could lose their grip. There is an increased danger of skidding and accidents.

Do not shift down for additional engine braking on a slippery road surface.

Drive particularly carefully on slippery road surfaces. Avoid sudden acceleration, steering and braking maneuvers. Do not use the cruise control or DISTRONIC PLUS.

If the vehicle threatens to skid or cannot be stopped when moving at low speed:

► Shift the transmission to position **N**.

 For more information on driving with snow chains, see (▷ page 317).

The outside temperature indicator is not designed to serve as an ice-warning device and is therefore unsuitable for that purpose. Changes in the outside temperature are displayed after a short delay.

Indicated temperatures just above the freezing point do not guarantee that the road surface is free of ice. The road may still be icy, especially in wooded areas or on bridges. The vehicle could skid if you fail to adapt your driving style. Always adapt your driving style and drive at a speed to suit the prevailing weather conditions.

You should pay special attention to road conditions when temperatures are around freezing point.

Driving systems

Cruise control

Important safety notes

Cruise control maintains a constant road speed for you. It brakes automatically in order to avoid exceeding the set speed. On long and steep downhill gradients, especially if the vehicle is laden, you must select shift range **1**, **2** or **3** in good time. By doing so, you will make use of the braking effect of the engine. This relieves the load on the brake system and prevents the brakes from overheating and wearing too quickly.

Use cruise control only if road and traffic conditions make it appropriate to maintain a steady speed for a prolonged period. You can

store any road speed above 20 mph (30 km/h).

If you fail to adapt your driving style, cruise control can neither reduce the risk of an accident nor override the laws of physics. Cruise control cannot take into account the road, traffic and weather conditions. Cruise control is only an aid. You are responsible for the distance to the vehicle in front, for vehicle speed, for braking in good time and for staying in your lane.

Do not use cruise control:

- in road and traffic conditions which do not allow you to maintain a constant speed e.g. in heavy traffic or on winding roads
- on slippery road surfaces. Braking or accelerating could cause the drive wheels to lose traction and the vehicle could then skid
- when there is poor visibility, e.g. due to fog, heavy rain or snow

If there is a change of drivers, advise the new driver of the speed stored.

Cruise control lever

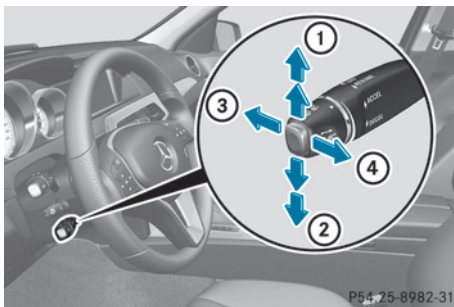

- ① To activate or increase speed
- ② To activate or reduce speed
- ③ To deactivate cruise control
- ④ To activate at the current speed/last stored speed

When you activate cruise control, the stored speed is shown in the multifunction display for five seconds. In the multifunction display,

the segments between the stored speed and the maximum speed light up.

Storing and maintaining the current speed

You can store the current speed if you are driving faster than 20 mph (30 km/h).

- ▶ Accelerate the vehicle to the desired speed.
- ▶ Briefly press the cruise control lever up ① or down ②.
- ▶ Remove your foot from the accelerator pedal. Cruise control is activated. The vehicle automatically maintains the stored speed.

i Cruise control may be unable to maintain the stored speed on uphill gradients. The stored speed is resumed when the gradient evens out. Cruise control maintains the stored speed on downhill gradients by automatically applying the brakes.

Storing the current speed or calling up the last stored speed

⚠ WARNING

If you call up the stored speed and it differs from the current speed, the vehicle accelerates or decelerates. If you do not know the stored speed, the vehicle could accelerate or brake unexpectedly. There is a risk of an accident.

Pay attention to the road and traffic conditions before calling up the stored speed. If you do not know the stored speed, store the desired speed again.

- ▶ Briefly pull the cruise control lever towards you ④.
- ▶ Remove your foot from the accelerator pedal. The first time cruise control is activated, it stores the current speed or regulates the speed of the vehicle to the previously stored speed.

Setting a speed

Keep in mind that it may take a brief moment until the vehicle has accelerated or braked to the speed set.

- ▶ Press the cruise control lever up ① for a higher speed or down ② for a lower speed.

- ▶ **To adjust the set speed in 1 mph increments (1 km/h increments):** briefly press the cruise control lever up ① or down ② to the pressure point.

Every time the cruise control lever is pressed up ① or down ② the last speed stored is increased or reduced.

- ▶ **To adjust the set speed in 5 mph increments (10 km/h increments):** briefly press the cruise control lever up ① or down ② beyond the pressure point.
Every time the cruise control lever is pressed up ① or down ② the last speed stored is increased or reduced.

- ❗ Cruise control is not deactivated if you depress the accelerator pedal. For example, if you accelerate briefly to overtake, cruise control adjusts the vehicle's speed to the last speed stored after you have finished overtaking.

Deactivating cruise control

There are several ways to deactivate cruise control:

- ▶ Briefly press the cruise control lever forwards ③.

or

- ▶ Brake.

Cruise control is automatically deactivated if:

- you depress the parking brake.
- you are driving at less than 20 mph (30 km/h).
- ESP® intervenes or you deactivate ESP®.
- you shift the transmission to position **N** while driving.

If cruise control is deactivated, you will hear a warning tone. You will see the **Cruise Control Off** message in the multifunction display for approximately five seconds.

- ❗ When you switch off the engine, the last speed stored is cleared.

DISTRONIC PLUS

Important safety notes

DISTRONIC PLUS regulates the speed and automatically helps you maintain the distance to the vehicle detected in front. DISTRONIC PLUS brakes automatically so that the set speed is not exceeded.

On long and steep downhill gradients, especially if the vehicle is laden, you must select shift range **1**, **2** or **3** in good time. By doing so, you will make use of the braking effect of the engine. This relieves the load on the brake system and prevents the brakes from overheating and wearing too quickly.

If DISTRONIC PLUS detects a slower-moving vehicle in front, your vehicle is braked in order to maintain the preset distance to the vehicle in front.

⚠ WARNING

DISTRONIC PLUS does not react to:

- people or animals
- stationary obstacles on the road, e.g. stopped or parked vehicles
- oncoming and crossing traffic

As a result, DISTRONIC PLUS may neither give warnings nor intervene in such situations. There is a risk of an accident.

Always pay careful attention to the traffic situation and be ready to brake.

⚠ WARNING

DISTRONIC PLUS cannot always clearly identify other road users and complex traffic situations.

In such cases, DISTRONIC PLUS may:

- give an unnecessary warning and then brake the vehicle
- neither give a warning nor intervene
- accelerate unexpectedly

There is a risk of an accident.

Continue to drive carefully and be ready to brake, in particular when warned to do so by DISTRONIC PLUS.

WARNING

DISTRONIC PLUS brakes your vehicle with up to 40% of the maximum braking force. If this braking force is insufficient, DISTRONIC PLUS warns you visually and audibly. There is a risk of an accident.

In such cases, apply the brakes yourself and try to take evasive action.

! If DISTRONIC PLUS or the HOLD function is activated, the vehicle brakes automatically in certain situations. To prevent damage to the vehicle, deactivate DISTRONIC PLUS and the HOLD function in the following or other similar situations:

- when towing the vehicle
- in the car wash

If you fail to adapt your driving style, DISTRONIC PLUS can neither reduce the risk of accident nor override the laws of physics. DISTRONIC PLUS cannot take into account the road, traffic and weather conditions. DISTRONIC PLUS is only an aid. You are responsible for the distance to the vehicle in front, for vehicle speed, for braking in good time and for staying in your lane.

Do not use DISTRONIC PLUS:

- in road and traffic conditions which do not allow you to maintain a constant speed e.g. in heavy traffic or on winding roads
- on slippery road surfaces. Braking or accelerating could cause the drive wheels

to lose traction and the vehicle could then skid

- when there is poor visibility, e.g. due to fog, heavy rain or snow

DISTRONIC PLUS may not detect narrow vehicles driving in front, e.g. motorcycles, or vehicles driving on a different line.

In particular, the detection of obstacles can be impaired if:

- dirt on the sensors or anything else covering the sensors
- snow or heavy rain
- interference by other radar sources
- strong radar reflections, for example, in parking garages

If DISTRONIC PLUS no longer detects a vehicle in front, DISTRONIC PLUS may unexpectedly accelerate the vehicle to the stored speed.

This speed may:

- be too high if you are driving in a filter lane or an exit lane
- be so high when driving in the right-hand lane that you overtake vehicles in the left-hand lane
- be so high when driving in the left-hand lane that you overtake vehicles in the right-hand lane

If there is a change of drivers, advise the new driver of the speed stored.

If there is no vehicle in front, DISTRONIC PLUS operates in the same way as cruise control in the speed range between 20 mph (Canada: 30 km/h) and 120 mph (Canada: 200 km/h). If a vehicle is driving in front of you, it operates in the speed range between 0 mph (0 km/h) and 120 mph (Canada: 200 km/h).

Do not use DISTRONIC PLUS while driving on roads with steep gradients.

As DISTRONIC PLUS transmits radar waves, it can resemble the radar detectors of the responsible authorities. You can refer to the

relevant chapter in the Operator's Manual if questions are asked about this.

i USA only:

This device has been approved by the FCC as a "Vehicular Radar System". The radar sensor is intended for use in an automotive radar system only. Removing, tampering with, or altering the device will void any warranties, and is not permitted by the FCC. Do not tamper with, alter, or use in any non-approved way.

Any unauthorized modification to this device could void the user's authority to operate the equipment.

i Canada only: This device complies with RSS-210 of Industry Canada. Operation is subject to the following two conditions:

1. This device may not cause harmful interference, and

2. this device must accept any interference received, including interference that may cause undesired operation of the device.

Removal, tampering, or altering of the device will void any warranties, and is not permitted. Do not tamper with, alter, or use in any non-approved way.

Any unauthorized modification to this device could void the user's authority to operate the equipment.

Cruise control lever

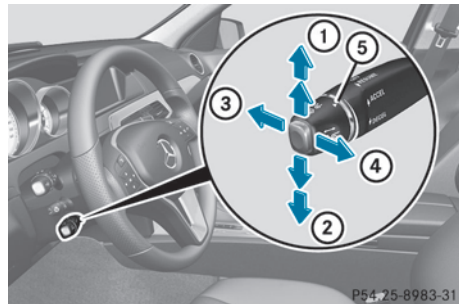

- ① To store the current speed or a higher speed
- ② To store the current speed or a lower speed
- ③ To deactivate DISTRONIC PLUS
- ④ To store the current speed or call up the last stored speed
- ⑤ To set the specified minimum distance

Switching on DISTRONIC PLUS, storing and maintaining the current speed

Activation conditions

In order to activate DISTRONIC PLUS, the following conditions must be fulfilled:

- the engine must be started. It may take up to two minutes after pulling away before DISTRONIC PLUS is operational.
- the parking brake must be released.
- ESP® must be active, but not intervening.
- the transmission must be in position **D**.
- the hood must be closed.
- the driver's door must be closed when you shift from **P** to **D** or your seat belt must be fastened.
- the front-passenger door and rear doors must be closed.
- the vehicle must not skid.

Activating while driving

When driving at speeds below 20 mph (30 km/h), you can only activate DISTRONIC PLUS if the vehicle in front has been detected

and is shown in the multifunction display. If the vehicle in front is no longer detected and displayed, DISTRONIC PLUS switches off and a tone sounds.

- ▶ Briefly pull the cruise control lever towards you ④, or press it up ① or down ②. DISTRONIC PLUS is selected.
- ▶ Press the cruise control lever repeatedly up ① or down ② until the desired speed is set.
- ▶ Remove your foot from the accelerator pedal. Your vehicle adapts its speed to that of the vehicle in front, but only up to the desired stored speed.

i If you do not fully release the accelerator pedal, the **DISTRONIC PLUS Override** message appears in the multifunction display. The set distance to a slower-moving vehicle in front will then not be maintained. You will be driving at the speed you determine by the position of the accelerator pedal.

Activating when driving towards a stationary vehicle

If the vehicle in front of you is stationary, you can only activate DISTRONIC PLUS once your vehicle is stationary as well.

- ▶ Briefly pull the cruise control lever towards you ④, or press it up ① or down ②. DISTRONIC PLUS is selected.
- i** DISTRONIC PLUS can only be activated at under 20 mph (30 km/h) if a vehicle in front has been detected. For this reason, it is helpful if you have the DISTRONIC PLUS distance display shown in the instrument cluster (▷ page 213).
- ▶ Press the cruise control lever repeatedly up ① or down ② until the desired speed is set.
- i** You can use the cruise control lever to set the stored speed and the control on the

cruise control lever to set the specified minimum distance (▷ page 178).

Pulling away

- ▶ **If the vehicle in front pulls away:** remove your foot from the brake pedal.
- ▶ Briefly pull the cruise control lever towards you ④.

or

- ▶ Accelerate briefly. Your vehicle pulls away and adapts its speed to that of the vehicle in front.

Driving

If there is no vehicle in front, DISTRONIC PLUS operates in the same way as cruise control.

If DISTRONIC PLUS detects that the vehicle in front has slowed down, it brakes your vehicle. In this way, the distance you have selected is maintained.

If DISTRONIC PLUS detects that the vehicle in front is driving faster, it accelerates your vehicle, but only up to the speed you have stored.

Changing lanes

If you change to the passing lane, DISTRONIC PLUS supports you when:

- you are driving faster than 40 mph (60 km/h)
- DISTRONIC PLUS is maintaining the distance to a vehicle in front
- you switch on the appropriate turn signal
- DISTRONIC PLUS does not detect a danger of collision

If these conditions are fulfilled, your vehicle is accelerated. Acceleration will be interrupted if changing lanes takes too long or if the distance between your vehicle and the vehicle in front becomes too small.

- i** When changing lanes, DISTRONIC PLUS monitors the left lane on left-hand drive vehicles and the right lane on right-hand drive vehicles.

Stopping

WARNING

When leaving the vehicle, even if it is braked only by DISTRONIC PLUS, it could roll away if:

- there is a malfunction in the system or in the voltage supply.
- DISTRONIC PLUS has been deactivated with the cruise control lever, e.g. by a vehicle occupant or from outside the vehicle.
- the electrical system in the engine compartment, the battery or the fuses have been tampered with.
- the battery is disconnected.
- the accelerator pedal has been depressed, e.g. by a vehicle occupant.

There is a risk of an accident.

If you wish to exit the vehicle, always turn off DISTRONIC PLUS and secure the vehicle against rolling away.

Deactivating DISTRONIC PLUS (▷ page 179).

If DISTRONIC PLUS detects that the vehicle in front is stopping, it brakes your vehicle until it is stationary.

Once your vehicle is stationary, it remains stationary and you do not need to depress the brake.

- i** Depending on the specified minimum distance, your vehicle will come to a standstill at a sufficient distance behind the vehicle in front. The specified minimum distance is set using the control on the cruise control lever.

You will see a warning message in the multifunction display if DISTRONIC PLUS is activated and:

- the driver's door is open and the driver's seat belt is unfastened.
- the engine is switched off.
- the hood is opened.

Shift to 'P'

- ▶ Shift the transmission to position **P** to prevent the vehicle from rolling away. DISTRONIC PLUS is deactivated. The warning message in the multifunction display disappears.

The horn will also sound at regular intervals if DISTRONIC PLUS is activated and you:

- switch the engine off, open the driver's door and remove your seat belt.
- open the hood.

The sounding of the horn alerts you to the fact that the vehicle has been parked while DISTRONIC PLUS is still activated. The sound becomes louder if you attempt to lock the vehicle. The vehicle is not locked until DISTRONIC PLUS is deactivated.

- i** If the engine has been switched off, it cannot be started again until DISTRONIC PLUS has been deactivated.

If DISTRONIC PLUS is activated and a malfunction occurs in the system or if there is a disruption in the voltage supply, the **Brake Immediately** message is shown in the multifunction display. Depress the brake firmly immediately until the warning message disappears from the multifunction display or shift the transmission to position **P**. DISTRONIC PLUS is then deactivated.

Setting a speed

- ▶ Press the cruise control lever up **①** for a higher speed or down **②** for a lower speed.
- ▶ **To adjust the set speed in 1 mph increments (1 km/h increments):** briefly press the cruise control lever up **①** or down **②** to the pressure point. Every time the cruise control lever is pressed up **①** or down **②** the last speed stored is increased or reduced.
- ▶ **To adjust the set speed in 5 mph increments (10 km/h increments):** briefly press the cruise control lever

up ① or down ② beyond the pressure point.
Every time the cruise control lever is pressed up ① or down ②, the last speed stored is increased or reduced.

- ① **DISTRONIC PLUS** is not deactivated if you depress the accelerator pedal. If you accelerate to overtake, **DISTRONIC PLUS** adjusts the vehicle's speed to the last speed stored after you have finished overtaking.

Storing the current speed or calling up a stored speed

- ▶ Briefly pull the cruise control lever towards you ④.
- ▶ Remove your foot from the accelerator pedal.
DISTRONIC PLUS is activated. The first time it is activated, the current speed is stored. Otherwise, it sets the vehicle cruise speed to the previously stored value.

Setting the specified minimum distance

You can set the specified minimum distance for **DISTRONIC PLUS** by varying the time span between one and two seconds. With this function, you can set the minimum distance that **DISTRONIC PLUS** keeps to the vehicle in front, dependent on vehicle speed. You can see this distance in the multifunction display (▶ page 179).

- ① Make sure that you maintain a sufficient distance to the vehicle in front and comply with the minimum distance as required by law. Adjust the distance to the vehicle in front if necessary.

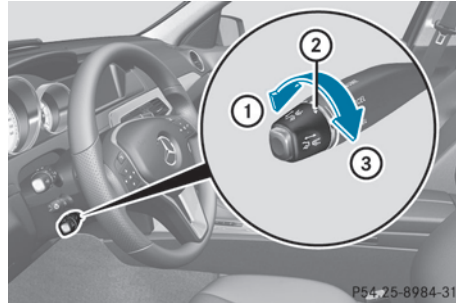

- ▶ **To increase:** turn control ② in direction ③.
DISTRONIC PLUS then maintains a greater distance between your vehicle and the vehicle in front.
- ▶ **To decrease:** turn control ② in direction ①.
DISTRONIC PLUS then maintains a shorter distance between your vehicle and the vehicle in front.

DISTRONIC PLUS displays in the speedometer



When **DISTRONIC PLUS** is activated, one or two segments ② in the set speed range light up.

- ① For design reasons, the speed displayed in the speedometer may differ slightly from the speed set for **DISTRONIC PLUS**.

If **DISTRONIC PLUS** detects a vehicle in front, segments ② between speed of the vehicle in front ① and stored speed ③ light up.

DISTRONIC PLUS displays in the multifunction display

General notes

In the Assistance menu (▷ page 213) of the on-board computer, you can select the assistance display.

Display when DISTRONIC PLUS is deactivated

- ▶ Select the **Assist. Graphic** function using the on-board computer (▷ page 213).

When DISTRONIC PLUS is deactivated, you will see the following in the multifunction display:

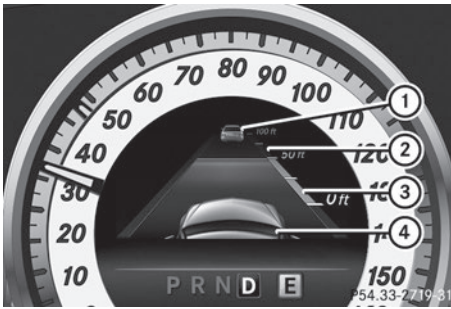

Example: vehicles with automatic transmission

- ① Vehicle in front, if detected
- ② Distance indicator, current distance to the vehicle in front
- ③ Specified minimum distance to the vehicle in front; adjustable
- ④ Own vehicle

Display when DISTRONIC PLUS is activated

- ▶ Select the **Assist. Graphic** function using the on-board computer (▷ page 213).

You will see the stored speed for about five seconds when you activate DISTRONIC PLUS. After this time, you will see the following in the multifunction display while DISTRONIC PLUS is activated:

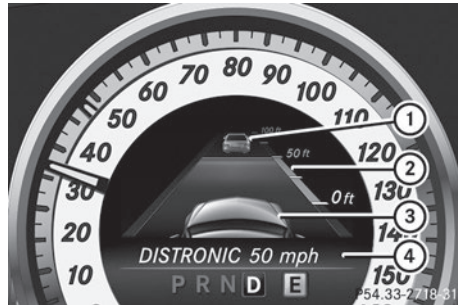

Example: vehicles with automatic transmission

- ① Vehicle in front, if detected
- ② Specified minimum distance to the vehicle in front; adjustable
- ③ Own vehicle
- ④ DISTRONIC PLUS activated

Deactivating DISTRONIC PLUS

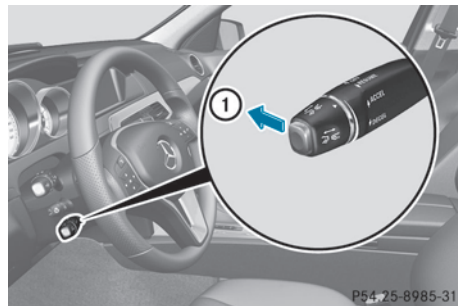

There are several ways to deactivate DISTRONIC PLUS:

- ▶ Briefly press the cruise control lever forwards ①.

or

- ▶ Brake, unless the vehicle is stationary.

When you deactivate DISTRONIC PLUS, you will see the **DISTRONIC PLUS Off** message in the multifunction display for approximately five seconds.

- ⓘ The last speed stored remains stored until you switch off the engine.

DISTRONIC PLUS is automatically deactivated if:

- you engage the parking brake
- you are driving slower than 15 mph (25 km/h) and there is no vehicle in front, or if the vehicle in front is no longer detected
- ESP® intervenes or you deactivate ESP®
- the transmission is in the **P**, **R** or **N** position
- you pull the cruise control lever towards you in order to pull away and the front-passenger door or one of the rear doors is open
- the vehicle has skidded

If DISTRONIC PLUS is deactivated, you will hear a warning tone. You will see the **DISTRONIC PLUS Off** message in the multifunction display for approximately five seconds.

If the vehicle has been stopped by DISTRONIC PLUS and a malfunction occurs in the system, the **Brake Immediately** message appears in the multifunction display. Depress the brake pedal immediately so that the vehicle does not roll away. DISTRONIC PLUS is then deactivated, and the message disappears.

Tips for driving with DISTRONIC PLUS

General notes

The following contains descriptions of certain road and traffic conditions in which you must be particularly attentive. In such situations, brake if necessary. DISTRONIC PLUS is then deactivated.

Cornering, going into and coming out of a bend

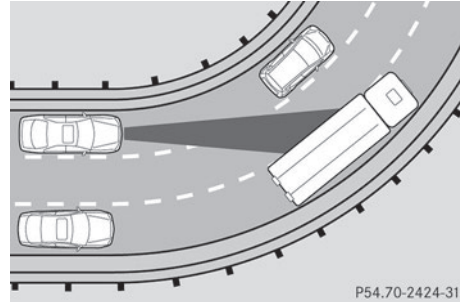

The ability of DISTRONIC PLUS to detect vehicles when cornering is limited. Your vehicle may brake unexpectedly or late.

Vehicles traveling on a different line

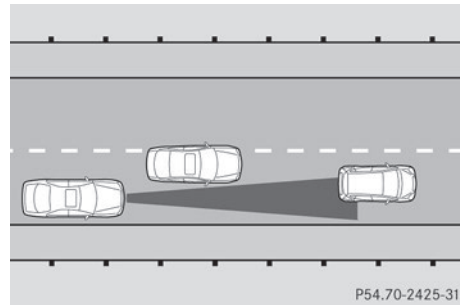

DISTRONIC PLUS may not detect vehicles traveling on a different line. The distance to the vehicle in front will be too short.

Other vehicles changing lanes

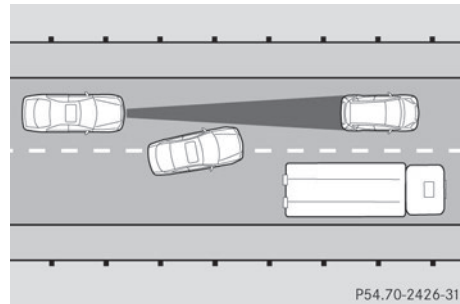

DISTRONIC PLUS has not detected the vehicle cutting in yet. The distance to this vehicle will be too short.

Narrow vehicles

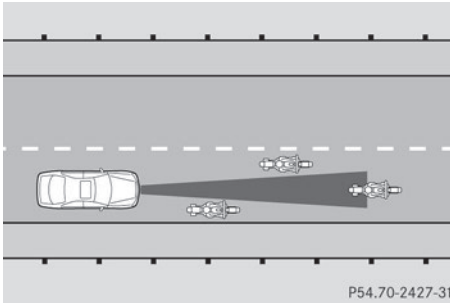

DISTRONIC PLUS has not yet detected the vehicle in front on the edge of the road, because of its narrow width. The distance to the vehicle in front will be too short.

Obstructions and stationary vehicles

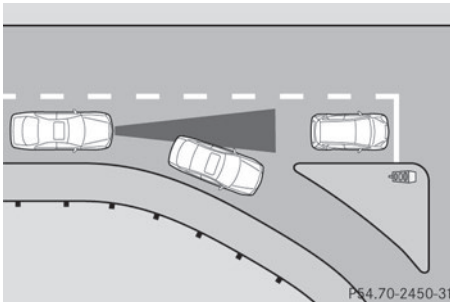

DISTRONIC PLUS does not brake for obstacles or stationary vehicles. If, for example, the detected vehicle turns a corner and reveals an obstacle or stationary vehicle, DISTRONIC PLUS will not brake for these.

Crossing vehicles

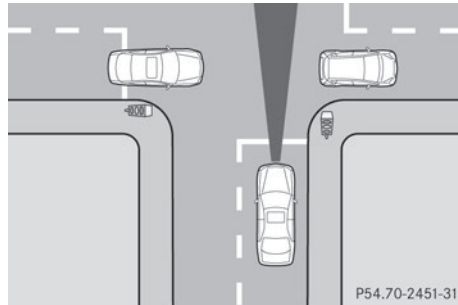

DISTRONIC PLUS may mistakenly detect vehicles that are crossing your lane. Activating DISTRONIC PLUS at traffic lights with crossing traffic, for example, could cause your vehicle to pull away unintentionally.

Dynamic handling package with sports mode

General notes

The most important part of the dynamic handling package with sports mode is the adjustable damping system. This automatically controls and adapts the suspension to the respective driving situation.

The calibration of the suspension depends on:

- your driving style
- the road surface conditions
- your individual selection; see the following description

The dynamic handling package with sports mode also includes steering wheel paddle shifters (▷ page 157) with a manual drive program (▷ page 159).



Example: position of dynamic handling package with sports mode button

- Start the engine.

Sports tuning

The firmer setting of the suspension tuning in sports mode ensures even better contact with the road. Select this mode when employing a sporty driving style, e.g. on winding country roads.

Your selection remains stored until you switch off the engine.

- Press button ②.
Indicator lamp ① lights up. Sports suspension tuning is selected. Depending on the engine output, the accelerator pedal is more responsive. On vehicles with automatic transmission, drive program **S** is selected.

Comfort tuning

In comfort mode, the driving characteristics of your vehicle are more comfortable. Therefore, select this mode if you favor a more comfortable driving style. Select comfort mode also when driving fast on straight roads, e.g. on straight stretches of freeway.

- Press button ②.
Indicator lamp ① goes out. Comfortable suspension tuning is selected. On vehicles with automatic transmission, drive program **E** is selected.

HOLD function

General notes

The HOLD function can assist the driver in the following situations:

- when pulling away, especially on steep slopes
- when maneuvering on steep slopes
- when waiting in traffic

The vehicle is kept stationary without the driver having to depress the brake pedal.

The braking effect is canceled and the HOLD function deactivated when you depress the accelerator pedal to pull away.

Important safety notes

WARNING

When leaving the vehicle, it can still roll away despite being braked by the HOLD function if:

- there is a malfunction in the system or in the voltage supply.
- the HOLD function has been deactivated by pressing the accelerator pedal or the brake pedal, e.g. by a vehicle occupant.
- the electrical system in the engine compartment, the battery or the fuses have been tampered with.
- the battery is disconnected

There is a risk of an accident.

If you wish to exit the vehicle, always turn off the HOLD function and secure the vehicle against rolling away.

- ❗ If DISTRONIC PLUS or the HOLD function is activated, the vehicle brakes automatically in certain situations. To prevent damage to the vehicle, deactivate DISTRONIC PLUS and the HOLD function in the following or other similar situations:

- when towing the vehicle
- in the car wash

Deactivating the HOLD function (▷ page 183).

Activation conditions

You can activate the HOLD function if:

- the vehicle is stationary
- the engine is running or if it has been automatically switched off by the ECO start/stop function
- the driver's door is closed or your seat belt is fastened
- the parking brake is released
- the hood is closed.
- the transmission is in position **D**, **R** or **N**
- DISTRONIC PLUS is deactivated

Activating the HOLD function

- ▶ Make sure that the activation conditions are met.
- ▶ Depress the brake pedal.
- ▶ Quickly depress the brake pedal further until **HOLD** appears in the multifunction display.
The HOLD function is activated. You can release the brake pedal.

- i** If depressing the brake pedal the first time does not activate the HOLD function, wait briefly and then try again.

Deactivating the HOLD function

The HOLD function is deactivated automatically if:

- you accelerate and the transmission is in position **D** or **R**.
- the transmission is in position **P**.
- you depress the brake pedal again with a certain amount of pressure until **HOLD** disappears from the multifunction display.
- you activate DISTRONIC PLUS.

You will see a warning message in the multifunction display if the HOLD function is activated and:

- the driver's door is open and the driver's seat belt is unfastened.
- the engine is switched off, unless it is automatically switched off by the ECO start/stop function.
- the hood is opened.

Shift to 'P'

- ▶ Shift the transmission to position **P** to prevent the vehicle from rolling away. The HOLD function is deactivated. The warning message in the multifunction display disappears.

The horn will also sound at regular intervals if the HOLD function is activated and you:

- switch the engine off, open the driver's door and remove your seat belt.
- open the hood.

The sounding of the horn alerts you to the fact that the vehicle has been parked while the HOLD function is still activated. If you attempt to lock the vehicle, the tone becomes louder. The vehicle is not locked until the HOLD function is deactivated.

- i** If the engine has been switched off, it cannot be started again until the HOLD function has been deactivated.

If there is a malfunction in the system or power supply while the HOLD function is activated, the **Brake Immediately** message is shown in the multifunction display.

Immediately depress the brake firmly until the warning message in the multifunction display goes out.

You can also shift the transmission to position **P**. This deactivates the HOLD function.

RACE START

Important safety notes

- i** Observe the safety notes for the SPORT handling mode (> page 69).

RACE START is intended solely for activation on dedicated race circuits. Always adapt your

speed and driving style to the prevailing road and weather conditions.

RACE START enables optimal acceleration from a standing start. The precondition for this is a suitable high-grip road surface.

- ❗ RACE START is only available in AMG vehicles.

Conditions for activation

You can activate RACE START if:

- the doors are closed
- the engine is running and it has reached an operating temperature of approximately 176 °F (80 °C) This is the case when the engine oil temperature in the multifunction display stops flashing.
- SPORT handling mode is activated (▷ page 69)
- the steering wheel is in the straight-ahead position
- the vehicle is stationary and the brake pedal is depressed (left foot)
- the transmission is in position **D**

Activating RACE START

- ▶ Depress the brake pedal with your left foot and keep it depressed.
- ▶ Turn the drive program selector clockwise (▷ page 156) until the **RS** lamp lights up. The **RACE START Confirm: Paddle UP Cancel: Paddle DOWN** message appears in the multifunction display.
- ❗ If the activation conditions are no longer fulfilled, RACE START is canceled. The multifunction display shows the **RACE START Canceled** message.

- ▶ To cancel: pull the left steering wheel paddle shifter (▷ page 157).

or

- ▶ To confirm: pull the right steering wheel paddle shifter (▷ page 157).

The **RACE START Available Depress gas pedal** message appears in the multifunction display.

- ❗ If you do not depress the accelerator pedal fully within two seconds, RACE START is canceled. The **RACE START Not Possible See Operator's Manual** message appears in the multifunction display.

- ▶ Fully depress the accelerator pedal. The engine speed rises to approximately 3,500 rpm.

The **RACE START Release brake to start** message appears in the multifunction display.

- ❗ If you do not release the brake pedal within five seconds, RACE START is canceled. The multifunction display shows the **RACE START Canceled** message.

- ▶ Take your foot off the brake, but keep the accelerator pedal depressed.

The vehicle pulls away at maximum acceleration.

The **RACE START Active** message appears in the multifunction display.

RACE START is deactivated when the vehicle reaches a speed of approximately 30 mph (Canada: 50 km/h). Drive program **S+** is activated. SPORT handling mode remains activated.

RACE START is deactivated immediately if you release the accelerator pedal during RACE START or if any of the activation conditions are no longer fulfilled. The **RACE START Not Possible See Operator's Manual** message appears in the multifunction display.

- ❗ If RACE START is used repeatedly within a short period of time, it is only available

again after the vehicle has been driven a certain distance.

4MATIC (permanent four-wheel drive)

4MATIC ensures that all four wheels are permanently driven. Together with ESP®, it improves the traction of your vehicle whenever a drive wheel spins due to insufficient grip.

If you fail to adapt your driving style, 4MATIC can neither reduce the risk of accident nor override the laws of physics. 4MATIC cannot take account of road, weather and traffic conditions. 4MATIC is only an aid. You are responsible for the distance to the vehicle in front, for vehicle speed, for braking in good time and for staying in your lane.

If a drive wheel spins due to insufficient grip:

- Only depress the accelerator pedal as far as necessary when pulling away.
- Accelerate less when driving.

! Never tow the vehicle with one axle raised. This may damage the transfer case. Damage of this sort is not covered by the Mercedes-Benz Limited Warranty. All wheels must remain either on the ground or be fully raised. Observe the instructions for towing the vehicle with all wheels in full contact with the ground.

i In wintry driving conditions, the maximum effect of 4MATIC can only be achieved if you use winter tires (M+S tires), with snow chains if necessary.

PARKTRONIC

Important safety notes

PARKTRONIC is an electronic parking aid with ultrasonic sensors. It monitors the area around your vehicle using six sensors in the front bumper and four sensors in the rear bumper. PARKTRONIC indicates visually and

audibly the distance between your vehicle and an object.

PARKTRONIC is only an aid. It is not a replacement for your attention to your immediate surroundings. You are always responsible for safe maneuvering, parking and exiting a parking space. When maneuvering, parking or pulling out of a parking space, make sure that there are no persons, animals or objects in the area in which you are maneuvering.

! When parking, pay particular attention to objects above or below the sensors, such as flower pots or trailer drawbars.

PARKTRONIC does not detect such objects when they are in the immediate vicinity of the vehicle. You could damage the vehicle or the objects.

The sensors may not detect snow and other objects that absorb ultrasonic waves.

Ultrasonic sources such as an automatic car wash, the compressed-air brakes on a truck or a pneumatic drill could cause PARKTRONIC to malfunction.

PARKTRONIC may not function correctly on uneven terrain.

PARKTRONIC is activated automatically when you:

- switch on the ignition
- shift the transmission to position **D**, **R** or **N**
- release the parking brake

PARKTRONIC is deactivated at speeds above 11 mph (18 km/h). It is reactivated at lower speeds.

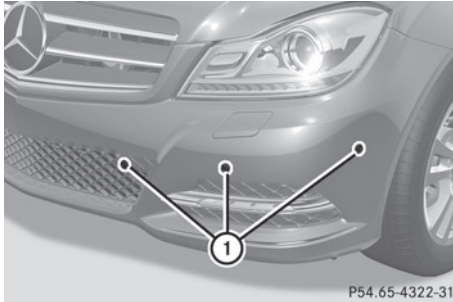

- ① Sensors in the front bumper, left-hand side (example)

Range of the sensors

General notes

PARKTRONIC does not take objects into consideration that are:

- below the detection range, e.g. people, animals or objects
- above the detection range, e.g. overhanging loads, truck overhangs or loading ramps

The sensors must be free from dirt, ice or slush. They can otherwise not function correctly. Clean the sensors regularly, taking care not to scratch or damage them (▷ page 295).

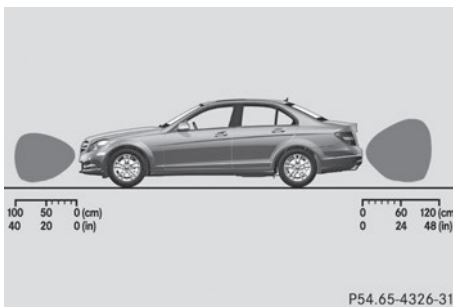

Side view

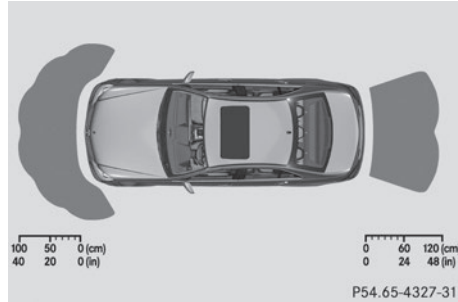

Top view

Front sensors

Center	Approx. 40 in (approx. 100 cm)
Corners	Approx. 24 in (approx. 60 cm)

Rear sensors

Center	Approx. 48 in (approx. 120 cm)
Corners	Approx. 32 in (approx. 80 cm)

Minimum distance

Center	Approx. 8 in (approx. 20 cm)
Corners	Approx. 6 in (approx. 15 cm)

If there is an obstacle within this range, the relevant warning displays light up and a warning tone sounds. If the distance falls below the minimum, the distance may no longer be shown.

Warning displays

The warning displays show the distance between the sensors and the obstacle. The warning display for the front area is located on the dashboard above the center air vents. The warning display for the rear area is

located on the headliner in the rear compartment.

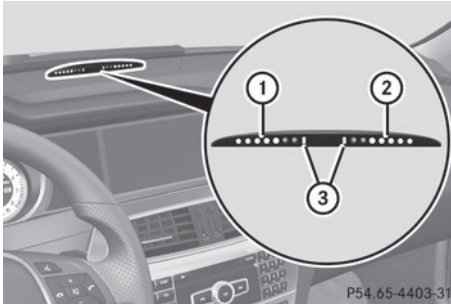

Warning display for the front area

- ① Segments on the left-hand side of the vehicle
- ② Segments on the right-hand side of the vehicle
- ③ Segments showing operational readiness

The warning display for each side of the vehicle is divided into five yellow and two red segments. PARKTRONIC is operational if yellow segments showing operational readiness ③ light up.

The selected transmission position and the direction in which the vehicle is rolling determine which warning display is active when the engine is running.

Transmission position	Warning display
D	Front area activated
R, N or the vehicle is rolling backwards	Rear and front areas activated
P	No areas activated

One or more segments light up as the vehicle approaches an obstacle, depending on the vehicle's distance from the obstacle.

From the:

- sixth segment onwards, you will hear an intermittent warning tone for approximately two seconds.
- seventh segment onwards, you will hear a warning tone for approximately two seconds. This indicates that you have now reached the minimum distance.

Deactivating/activating PARKTRONIC



- ① Indicator lamp
- ② Deactivating/activating PARKTRONIC

If indicator lamp ① lights up, PARKTRONIC is deactivated. Parking Guidance is also deactivated.

- ❗ PARKTRONIC is automatically activated when you turn the SmartKey to position 2 in the ignition lock.

Problems with PARKTRONIC

Problem	Possible causes/consequences and ► Solutions
Only the red segments in the PARKTRONIC warning displays are lit. You also hear a warning tone for approximately two seconds. PARKTRONIC is deactivated after approximately 20 seconds, and the indicator lamp in the PARKTRONIC button lights up.	PARKTRONIC has malfunctioned and has switched off. ► If problems persist, have PARKTRONIC checked at a qualified specialist workshop.
Only the red segments in the PARKTRONIC warning displays are lit. PARKTRONIC is deactivated after approximately 20 seconds.	The PARKTRONIC sensors are dirty or there is interference. ► Clean the PARKTRONIC sensors (▷ page 295). ► Switch the ignition back on.
	The problem may be caused by an external source of radio or ultrasound waves. ► See if PARKTRONIC functions in a different location.

Parking Guidance

Important safety notes

Parking Guidance is an electronic parking aid with ultrasound. Ultrasound is used to measure the road on both sides of the vehicle. A suitable parking space is indicated by the parking symbol. You receive steering instructions when parking. You may also use PARKTRONIC (▷ page 185).

Parking Guidance is only an aid. It is not a replacement for your attention to your immediate surroundings. You are always responsible for safe maneuvering, parking and exiting a parking space. When maneuvering, parking or pulling out of a parking space, make sure that there are no persons, animals or objects in the area in which you are maneuvering.

 **WARNING**

If objects are located above the detection range, Parking Guidance may provide steering instructions too soon. You may cause a collision as a result. There is a risk of an accident.

If objects are located above the detection range, stop and switch off Parking Assist.

! Pay particular attention to low objects or objects with flat surfaces, such as trailer drawbars, posts, cross beams and curbs. These types of objects cannot be detected by Parking Guidance and may damage the vehicle.

When PARKTRONIC is deactivated, Parking Guidance is also unavailable.

Use Parking Guidance for parking spaces:

- that are parallel to the direction of travel
- that are on straight roads, not bends
- that are on the same level as the road, i.e. not on the pavement, for example. Parking Guidance may not detect flat curbs

Parking tips:

- On narrow roads, drive as close to the parking space as possible.
 - Parking spaces that are littered, overgrown or partially occupied by trailer drawbars might be identified incorrectly or not at all.
 - Snowfall or heavy rain may lead to a parking space being measured inaccurately.
 - Pay attention to the PARKTRONIC (> page 186) warning messages during the parking procedure.
 - When transporting a load which protrudes from your vehicle, you must not use Parking Guidance.
 - Never use Parking Guidance with snow chains or an emergency spare wheel mounted.
 - Make sure that the tire pressures are always correct. This has a direct effect on the steering instructions.
 - The way your vehicle is positioned in the parking space after parking is dependent on various factors. These include the position and shape of the vehicles parked in front and behind it and the conditions of the location. In some cases, Parking Guidance may guide you too far or not far enough into a parking space. In some cases, it may also lead you across or onto the curb. If necessary, cancel the parking procedure with Parking Guidance.
- !** If unavoidable, you should drive over obstacles such as curbs slowly and not at a sharp angle. Otherwise, you may damage the wheels or tires.

Detecting parking spaces



- ① Detected parking space on the left
- ② Parking symbol
- ③ Detected parking space on the right

Parking Guidance is automatically activated when you drive forwards. The system is operational at speeds of up to approximately 22 mph (35 km/h). While in operation, the system independently locates and measures parking spaces on both sides of the vehicle. When driving at speeds below 19 mph (30 km/h), you will see parking symbol ② as a status indicator in the instrument cluster.

When a parking space has been detected, an arrow towards the right ③ or the left ① also appears. Parking Guidance only displays parking spaces on the front-passenger side as standard. Parking spaces on the driver's side are displayed as soon as the turn signal on the driver's side is activated. To park on the driver's side, you must leave the driver's side turn signal switched on until you have engaged reverse gear.

Parking Guidance will only detect parking spaces:

- that are parallel to the direction of travel
- that are at least 5 ft (1.5 m) wide
- that are at least 4.3 ft (1.3 m) longer than your vehicle

A parking space is displayed while you are driving past it, and until you are approximately 50 ft (15 m) away from it.

Parking

- ▶ Stop the vehicle when the parking space symbol shows the desired parking space in the instrument cluster.
- ▶ Shift the transmission to position **R**. The multifunction display shows the **Check Vehicle Surroundings Press 'OK' to Confirm** message.
- ▶ Press the button on the multifunction steering wheel to confirm. The multifunction display switches to Parking Guidance.

Depending on your distance from the parking space, the **Please Drive Backward** message will appear in the multifunction display.



- ▶ If necessary, reverse towards the parking space. This is indicated by an arrow pointing backwards. Continue backing up until you hear a tone. Stop – the stop position has been reached. The arrow is white. The **Please Steer Wheel to the Right** or **Please Steer Wheel to the Left** message appears in the multifunction display.



- ▶ While the vehicle is stationary, turn the steering wheel in the specified direction

until the arrow is white and a warning tone sounds.

- ▶ **To reverse into the parking space:** maintain the steering wheel angle and reverse carefully.
- ▶ Stop as soon as you hear a warning tone. The vehicle has reached the position in which you need to countersteer. The **Please Steer Wheel to the Left** or **Please Steer Wheel to the Right** message appears in the multifunction display.
- ▶ **To countersteer:** while the vehicle is stationary, turn the steering wheel in the specified direction until the arrow is white and a warning tone sounds.
- ▶ **To reverse into the parking space:** maintain the steering wheel angle and reverse carefully.
- ▶ Stop as soon as you hear a warning tone, at the latest when PARKTRONIC sounds the continuous warning tone. The **Parking Guidance Finished** message appears in the multifunction display and a tone sounds. You may be asked to steer in a different direction and then change gear. In this case, further displays in the multifunction display will direct you to the final position.
- ▶ Maneuver if necessary.
- ▶ Always observe the warning messages displayed by PARKTRONIC (▷ page 186).

Canceling Parking Guidance

- ▶ Press the PARKTRONIC button on the center console (▷ page 187). Parking Guidance is canceled immediately and PARKTRONIC is deactivated.

Parking Guidance is canceled automatically if it is no longer possible to guide you into the parking space, or if a malfunction occurs.

The parking space symbol goes out and a warning tone sounds. The **Parking Guidance Canceled** message appears in the multifunction display.

Rear view camera

General notes

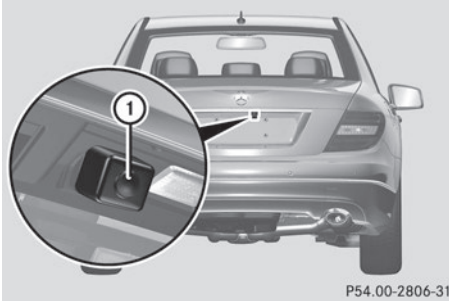

① Rear view camera

Rear view camera ① is an optical parking and maneuvering aid. It shows the area behind your vehicle in the COMAND display.

The rear view camera is located in the handle strip of the trunk lid.

Important safety notes

The rear view camera is only an aid. It is not a replacement for your attention to your immediate surroundings. You are always responsible for safe maneuvering and parking. When maneuvering or parking, make sure that there are no persons, animals or objects in the area in which you are maneuvering.

Under the following circumstances, the rear view camera will not function, or will function in a limited manner:

- if the trunk lid is open
- in heavy rain, snow or fog
- at night or in very dark places
- if the camera is exposed to very bright light
- if the area is lit by fluorescent light or LED lighting (the display may flicker)
- if there is a sudden change in temperature, e.g. when driving into a heated garage in winter

- if the camera lens is dirty or obstructed
- if the rear of your vehicle is damaged. In this event, have the camera position and setting checked at a qualified specialist workshop

The field of vision and other functions of the rear view camera may be restricted due to additional accessories on the rear of the vehicle (e.g. license plate holder, bicycle rack).

View through the camera

The area behind the vehicle is displayed as a mirror image, as in the rear view mirror.

The rear view camera may show a distorted view of obstacles, show them incorrectly or not at all. The rear view camera does not show objects in the following positions:

- very close to the rear bumper
- under the rear bumper
- in the area immediately above the tailgate handle

! Objects not at ground level may appear to be further away than they actually are, e.g.:

- the bumper of a parked vehicle
- the drawbar of a trailer
- the ball coupling of a trailer tow hitch
- the rear section of an HGV
- a slanted post

Use the guidelines only for orientation. Approach objects no further than the bottom-most guideline.

Activating the rear view camera

- ▶ Make sure that the SmartKey is in position **2** in the ignition lock.
- ▶ Make sure that the rear view camera function is selected in COMAND (see the separate operating instructions for COMAND).
- ▶ Engage reverse gear. The area behind the vehicle is shown in the COMAND display.

ATTENTION ASSIST

Important safety notes

ATTENTION ASSIST is only an aid to the driver. It might not always recognize fatigue or increasing inattentiveness in time or fail to recognize them at all. The system is not a substitute for a well-rested and attentive driver.

ATTENTION ASSIST helps you during long, monotonous journeys, such as on highways. It is active in the range between 50 mph (80 km/h) and 112 mph (180 km/h).

If ATTENTION ASSIST detects typical indicators of fatigue or increasing lapses in concentration on the part of the driver, it suggests you take a break.

ATTENTION ASSIST assesses your level of fatigue or lapses in concentration by taking the following criteria into account:

- your personal driving style, e.g. steering characteristics
- journey details, e.g. time of day and length of journey

The functionality of ATTENTION ASSIST is restricted and warnings may be delayed or not occur at all:

- if the road condition is poor, e.g. if the surface is uneven or if there are potholes
- if there is a strong side wind
- if you have adopted a sporty driving style with high cornering speeds or high rates of acceleration
- if you are predominantly driving slower than 50 mph (80 km/h) or faster than 112 mph (180 km/h)
- if you are currently using COMAND or making a telephone call with it
- if the time has been set incorrectly
- in active driving situations, such as when you change lanes or change your speed

Warning and display messages in the multifunction display

- ▶ Activate ATTENTION ASSIST using the on-board computer (▷ page 214).

If ATTENTION ASSIST is active, you will be warned no sooner than 20 minutes after your journey has begun. You then hear an intermittent warning tone twice and the **Attention Assist: Drowsiness detected** message appears in the multifunction display.

- ▶ If necessary, take a break.
- ▶ Press the **OK** button to confirm the message.

On long journeys, take regular breaks in good time to allow yourself to rest properly. If you do not take a break, you will be warned again after 15 minutes at the earliest. The precondition for this is that ATTENTION ASSIST still detects typical indicators of fatigue or increasing lapses in concentration.

ATTENTION ASSIST is reset when you continue your journey and starts assessing your tiredness again if:

- you switch off the engine.
- you take off your seat belt and open the driver's door, e.g. for a change of drivers or to take a break.

The assistance graphic shows the  symbol when ATTENTION ASSIST is deactivated (▷ page 213).

Lane Tracking package

General notes

The Lane Tracking package consists of Blind Spot Assist (▷ page 193) and Lane Keeping Assist (▷ page 194).

Blind Spot Assist

General notes

Blind Spot Assist uses a radar sensor system to monitor the areas on both sides of your vehicle. It supports you from a speed of approximately 20 mph (30 km/h). A warning display in the exterior mirrors draws your attention to vehicles detected in the monitored area. If you then switch on the corresponding turn signal to change lanes, you will also receive a visual and audible collision warning. Blind Spot Assist uses sensors in the rear bumper for monitoring purposes.

For Blind Spot Assist to assist you, the radar sensor system must be operational.

Important safety notes

Blind Spot Assist is only an aid. It may fail to detect some vehicles and is no substitute for attentive driving. Always ensure that there is sufficient distance to the side for other road users and obstacles.

WARNING

Blind Spot Assist does not react to:

- vehicles overtaken too closely on the side, placing them in the blind spot area
- vehicles which approach with a large speed differential and overtake your vehicle

As a result, Blind Spot Assist may not give warnings in such situations. There is a risk of an accident.

Always observe the traffic conditions carefully, and maintain a safe lateral distance.

USA only:

This device has been approved by the FCC as a "Vehicular Radar System". The radar sensor is intended for use in an automotive radar system only. Removing, tampering with, or altering the device will void any warranties, and is not permitted by the FCC. Do not tamper with, alter, or use in any non-approved way.

Any unauthorized modification to this device could void the user's authority to operate the equipment.

Monitoring range of the sensors

In particular, the detection of obstacles can be impaired if:

- dirt on the sensors or anything else covering the sensors
- poor visibility, e.g. due to fog, heavy rain, snow or spray
- narrow vehicles, e.g. motorcycles or bicycles
- the road has very wide lanes
- the road has narrow lanes
- you are not driving in the middle of the lane
- there are barriers or similar lane borders

Vehicles in the monitoring range are then not indicated.

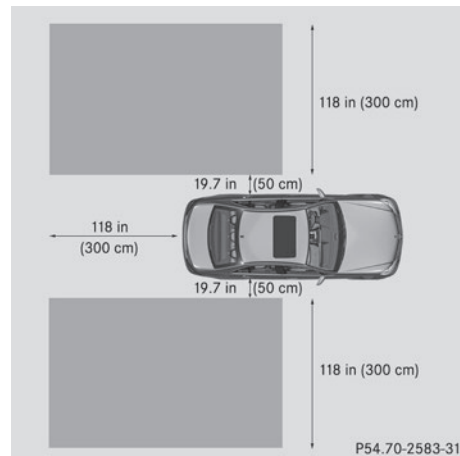

Blind Spot Assist monitors the area up to 10 ft (3 m) behind your vehicle and directly next to your vehicle, as shown in the diagram. If the lanes are narrow, vehicles driving in the lane beyond the lane next to your vehicle may be indicated, especially if the vehicles are not driving in the middle of their lane. This may be the case if there are vehicles driving at the inner edge of their lanes.

Due to the nature of the system:

- warnings may be issued in error when driving close to crash barriers or similar solid lane borders.
- the warning is canceled when driving for an extended period next to long vehicles, such as trucks.

The two radar sensors for Blind Spot Assist are integrated into the sides of the rear bumper. Make sure that the bumper is free of dirt, ice or slush in the vicinity of the sensors. The sensors must not be covered, for example by cycle racks or overhanging loads. Following a severe impact or in the event of damage to the bumpers, have the function of the sensors checked at a qualified specialist workshop. Blind Spot Assist may otherwise not work properly.

Indicator and warning display

Blind Spot Assist is not active at speeds below approximately 20 mph (30 km/h). Vehicles in the monitoring range are then not indicated.

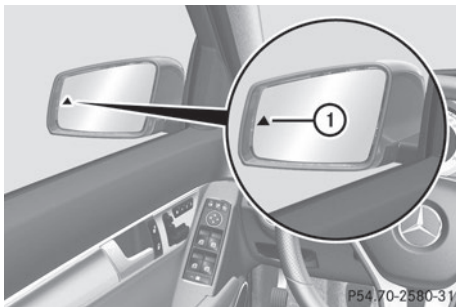

① Yellow indicator lamp/red warning lamp

When Blind Spot Assist is activated, indicator lamp ① in the exterior mirrors lights up yellow at speeds of up to 20 mph (30 km/h). At speeds above 20 mph (30 km/h), the indicator lamp goes out and Blind Spot Assist is operational.

If a vehicle is detected within the blind spot monitoring range at speeds above 20 mph (30 km/h), warning lamp ① on the corresponding side lights up red. This warning is always emitted when a vehicle enters the

blind spot monitoring range from behind or from the side. When you overtake a vehicle, the warning only occurs if the difference in speed is less than 7 mph (12 km/h).

The yellow indicator lamp goes out if reverse gear is engaged. In this event, Blind Spot Assist is no longer active.

The brightness of the indicator/warning lamps is adjusted automatically according to the ambient light.

Collision warning

If a vehicle is detected in the monitoring range of Blind Spot Assist and you switch on the corresponding turn signal, a double warning tone sounds. Red warning lamp ① flashes. If the turn signal remains on, vehicles detected are indicated by the flashing of red warning lamp ①. There are no further warning tones.

Switching on Blind Spot Assist

- ▶ Make sure that Blind Spot Assist (▷ page 214) is activated in the on-board computer.
- ▶ Turn the SmartKey to position **2** in the ignition lock.
Warning lamps ① in the exterior mirrors light up red for approximately 1.5 seconds and then turn yellow.

Lane Keeping Assist

General notes

Lane Keeping Assist monitors the area in front of your vehicle with camera ①, which is mounted at the top of the windshield. Lane Keeping Assist detects lane markings on the road and warns you before you leave your lane unintentionally.

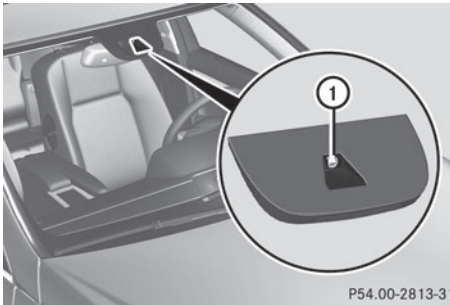

① Active Lane Keeping Assist camera

If you select **km** on the on-board computer in the **Display Unit Speed-/Odometer** function (> page 215), Lane Keeping Assist is active starting at a speed of 60 km/h. If the **miles** display unit is selected, the assistance range begins at 40 mph.

A warning may be given if a front wheel passes over a lane marking. It will warn you by means of intermittent vibration in the steering wheel for up to 1.5 seconds.

Important safety notes

If you fail to adapt your driving style, Lane Keeping Assist can neither reduce the risk of an accident nor override the laws of physics. Lane Keeping Assist cannot take into account the road, traffic and weather conditions. Lane Keeping Assist is merely an aid. You are responsible for the distance to the vehicle in front, for vehicle speed, for braking in good time and for staying in your lane.

WARNING

Lane Keeping Assist may not always clearly recognize lane markings.

In this case, Lane Keeping Assist may:

- give an unnecessary warning
- not give a warning

There is a risk of an accident.

Always pay particular attention to the traffic situation and stay in lane, in particular if warned by Lane Keeping Assist.

WARNING

The Lane Keeping Assist warning does not return the vehicle to the original lane. There is a risk of an accident.

You should always steer, brake or accelerate yourself, in particular if warned by Lane Keeping Assist.

The Lane Keeping Assist does not keep the vehicle in the lane.

The system may be impaired or may not function if:

- there is poor visibility, e.g. due to insufficient illumination of the road, or due to snow, rain, fog or spray
- there is glare, e.g. from oncoming traffic, the sun or reflections (e.g. when the road surface is wet)
- the windshield is dirty, fogged up, damaged or covered, for instance by a sticker, in the vicinity of the camera
- there are no, several or unclear lane markings for a lane, e.g. in areas with road construction work
- the lane markings are worn away, dark or covered up, e.g. by dirt or snow
- the distance to the vehicle in front is too small and the lane markings thus cannot be detected
- the lane markings change quickly, e.g. lanes branch off, cross one another or merge
- the road is narrow and winding
- there are strong shadows cast on the lane

Switching on Lane Keeping Assist

- ▶ Switch on Active Lane Keeping Assist using the on-board computer; to do so, select **Standard** or **Adaptive** (> page 214). If you drive at speeds above 40 mph (60 km/h) and lane markings are detected, the lines in the assistance graphics display (> page 213) are shown in green. Lane Keeping Assist is ready for use.

Standard

If **Standard** is selected, no warning vibration occurs if:

- you switch on the turn signals. In this event, the warnings are suppressed for a certain period of time.
- a driving safety system intervenes, such as ABS, BAS or ESP®.

Adaptive

When **Adaptive** is selected, no warning vibration occurs if:

- you switch on the turn signals. In this event, the warnings are suppressed for a certain period of time.
- a driving safety system intervenes, e.g. ABS, BAS or ESP®.
- you accelerate hard, e.g. kickdown.
- you brake hard.
- you steer actively, e.g. swerve to avoid an obstacle or change lanes quickly.
- you cut the corner on a sharp bend.

In order that you are warned only when necessary and in good time if you cross the lane marking, the system recognizes certain conditions and warns you accordingly.

The warning vibration occurs earlier if:

- you approach the outer lane marking on a bend.
- the road has very wide lanes, e.g. a highway.
- the system recognizes solid lane markings.

The warning vibration occurs later if:

- the road has narrow lanes.
- you cut the corner on a bend.

Active Driving Assistance package**General notes**

The Active Driving Assistance package consists of DISTRONIC PLUS (▷ page 173), Active Blind Spot Assist (▷ page 196) and Active Lane Keeping Assist (▷ page 199).

Active Blind Spot Assist**General notes**

Active Blind Spot Assist uses a radar sensor system to monitor the side areas of your vehicle which are behind the driver. A warning display in the exterior mirrors draws your attention to vehicles detected in the monitored area. If you then switch on the corresponding turn signal to change lane, you will also receive an optical and audible warning. If a risk of lateral collision is detected, corrective braking may help you avoid a collision. To support the course-correcting brake application, Active Blind Spot Assist uses the forward-facing radar sensor system. The free space is then evaluated in the direction of travel and to the side before a course-correcting brake application is initiated.

Active Blind Spot Assist supports you from a speed of approximately 20 mph (30 km/h).

For Active Blind Spot Assist to assist you when driving, the radar sensor system must be operational.

Important safety notes

Active Blind Spot Assist is only an aid. It does not detect all traffic situations and road users and is no substitute for attentive driving. Always ensure that there is sufficient distance to the side for other road users and obstacles.

⚠ WARNING

Active Blind Spot Assist does not react to:

- vehicles overtaken too closely on the side, placing them in the blind spot area
- vehicles which approach with a large speed differential and overtake your vehicle

As a result, Active Blind Spot Assist may neither give warnings nor intervene in such situations. There is a risk of an accident.

Always observe the traffic conditions carefully, and maintain a safe lateral distance.

i USA only:

This device has been approved by the FCC as a "Vehicular Radar System". The radar sensor is intended for use in an automotive radar system only. Removing, tampering with, or altering the device will void any warranties, and is not permitted by the FCC. Do not tamper with, alter, or use in any non-approved way.

Any unauthorized modification to this device could void the user's authority to operate the equipment.

i Canada only: This device complies with RSS-210 of Industry Canada. Operation is subject to the following two conditions:

1. This device may not cause harmful interference, and
2. this device must accept any interference received, including interference that may cause undesired operation of the device.

Removal, tampering, or altering of the device will void any warranties, and is not permitted. Do not tamper with, alter, or use in any non-approved way.

Any unauthorized modification to this device could void the user's authority to operate the equipment.

Monitoring range of the sensors

WARNING

Active Blind Spot Assist does not detect all traffic situations and road users. There is a risk of an accident.

Always make sure that there is sufficient distance on the side for other traffic or obstacles.

In particular, the detection of obstacles can be impaired if:

- dirt on the sensors or anything else covering the sensors
- poor visibility, e.g. due to rain, snow or spray

Vehicles in the monitoring range are then not indicated.

Active Blind Spot Assist may not detect narrow vehicles, such as motorcycles or bicycles, or may only detect them too late.

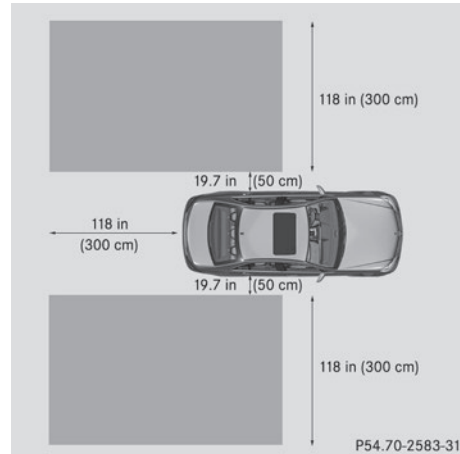

Active Blind Spot Assist monitors the area up to 10 ft (3 m) behind your vehicle and directly next to your vehicle, as shown in the diagram. For this purpose, Active Blind Spot Assist uses radar sensors in the rear bumper.

If the lanes are narrow, vehicles driving in the lane beyond the lane next to your vehicle may be indicated, especially if the vehicles are not driving in the middle of their lane. This may be the case if there are vehicles driving at the inner edge of their lanes.

Due to the nature of the system:

- warnings may be issued in error when driving close to crash barriers or similar solid lane borders.
- the warning is canceled when driving for an extended period next to long vehicles, such as trucks.

Two Active Blind Spot Assist radar sensors are integrated into the front and rear bumpers respectively. An additional radar sensor is located behind the cover in the radiator grill. Make sure that the sensors and areas around them are free of dirt, ice or slush. The rear sensors must not be covered, for example by cycle racks or overhanging cargo. Following a severe impact or in the event of damage to

the bumpers, have the function of the sensors checked at a qualified specialist workshop. Blind Spot Assist may otherwise not work properly.

Indicator and warning display

Active Blind Spot Assist is not active at speeds below approximately 20 mph (30 km/h). Vehicles in the monitoring range are then not indicated.

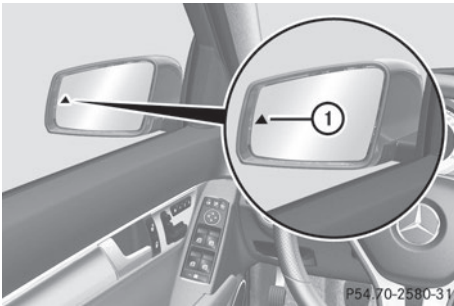

① Yellow indicator lamp/red warning lamp

When Active Blind Spot Assist is activated, indicator lamp ① in the exterior mirrors lights up yellow at speeds of up to 20 mph (30 km/h). At speeds above 20 mph (30 km/h), the indicator lamp goes out and Active Blind Spot Assist is operational.

If a vehicle is detected within the blind spot monitoring range at speeds above 20 mph (30 km/h), warning lamp ① on the corresponding side lights up red. This warning is always emitted when a vehicle enters the blind spot monitoring range from behind or from the side. When you overtake a vehicle, the warning only occurs if the difference in speed is less than 7 mph (12 km/h).

The yellow indicator lamp goes out if reverse gear is engaged. In this event, Active Blind Spot Assist is no longer active.

The brightness of the indicator/warning lamps is adjusted automatically according to the ambient light.

Visual and acoustic collision warning

When you switch on the turn signals to change lanes and a vehicle is detected in the side monitoring range, you receive a visual and acoustic collision warning. You then hear a double warning tone and red warning lamp ① flashes. If the turn signal remains on, detected vehicles are indicated by the flashing of red warning lamp ①. There are no further warning tones.

Course-correcting brake application

⚠ WARNING

A course-correcting brake application cannot always prevent a collision. There is a risk of an accident.

Always steer, brake or accelerate yourself, especially if Active Blind Spot Assist warns you or makes a course-correcting brake application. Always maintain a safe distance at the sides.

In very rare cases, the system may make an inappropriate brake application. An inappropriate brake application may be interrupted at any time if you steer slightly in the opposite direction or accelerate.

If Active Blind Spot Assist detects a risk of a lateral collision in the monitoring range, a course-correcting brake application is carried out. This is meant to assist you in avoiding a collision.

The course-correcting brake application is available in the speed range between 20 mph (30 km/h) and 120 mph (200 km/h).

If a course-correcting brake application occurs, red warning lamp ① flashes in the exterior mirror and the following is shown in the multifunction display, for example:



Either a very slight course-correcting brake application, or none at all, may occur if:

- there are vehicles or obstacles, e.g. crash barriers, located on both sides of your vehicle.
- a vehicle approaches you too closely at the side.
- you have adopted a sporty driving style with high cornering speeds.
- you clearly brake or accelerate.
- a driving safety system intervenes, e.g. ESP® or PRE-SAFE® Brake.
- ESP® is switched off.
- a loss of tire pressure or a defective tire is detected.

Switching on Active Blind Spot Assist

- ▶ Make sure that Active Blind Spot Assist (▷ page 214) is activated in the on-board computer.
- ▶ Turn the SmartKey to position **2** in the ignition lock.
Warning lamps ① in the exterior mirrors light up red for approximately 1.5 seconds and then turn yellow.

Active Lane Keeping Assist

General notes

Active Lane Keeping Assist monitors the area in front of your vehicle by means of a camera ① mounted at the top of the windshield. Active Lane Keeping Assist detects lane markings on the road and warns you before you leave your lane unintentionally. If you do not react to the warning, a lane-correcting application of the brakes can bring the vehicle back into the original lane.

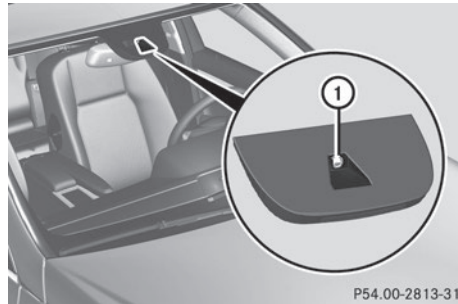

① Active Lane Keeping Assist camera

If you select **km** on the on-board computer in the **Display Unit Speed-/Odometer** function (▷ page 215), Active Lane Keeping Assist is activated starting at a speed of 60 km/h. If the **miles** display unit is selected, the assistance range begins at 40 mph.

Important safety notes

If you fail to adapt your driving style, Active Lane Keeping Assist can neither reduce the risk of accident nor override the laws of physics. Lane Keeping Assist cannot take into account the road, traffic and weather conditions. Lane Keeping Assist is merely an aid. You are responsible for the distance to the vehicle in front, for vehicle speed, for braking in good time and for staying in your lane.

Active Lane Keeping Assist cannot continuously keep your vehicle in its lane.

WARNING

Active Lane Keeping Assist cannot always clearly detect lane markings.

In such cases, Active Lane Keeping Assist can:

- give an unnecessary warning and then make a course-correcting brake application to the vehicle
- not give a warning or intervene

There is a risk of an accident.

Always pay particular attention to the traffic situation and keep within the lane, especially if Active Lane Keeping Assist alerts you.

Terminate the intervention in a non-critical driving situation.

The system may be impaired or may not function if:

- there is poor visibility, e.g. due to insufficient illumination of the road, or due to snow, rain, fog or spray
- there is glare, e.g. from oncoming traffic, the sun or reflections (e.g. when the road surface is wet)
- the windshield is dirty, fogged up, damaged or covered, for instance by a sticker, in the vicinity of the camera
- there are no, several or unclear lane markings for a lane, e.g. in areas with road construction work
- the lane markings are worn away, dark or covered up, e.g. by dirt or snow
- the distance to the vehicle in front is too small and the lane markings thus cannot be detected
- the lane markings change quickly, e.g. lanes branch off, cross one another or merge
- the road is narrow and winding
- there are highly variable shade conditions on the roadway
- no vehicle is detected in the adjacent lane and there are broken lane markings

Warning vibration in the steering wheel

A warning may be given if a front wheel passes over a lane marking. It will warn you by means of intermittent vibration in the steering wheel for up to 1.5 seconds.

In order that you are warned only when necessary and in good time if you cross the lane marking, the system recognizes certain conditions and warns you accordingly.

The warning vibration occurs earlier if:

- you approach the outer lane marking on a bend.
- the road has very wide lanes, e.g. a highway.
- the system recognizes solid lane markings.

The warning vibration occurs later if:

- the road has narrow lanes.
- you cut the corner on a bend.

Lane-correcting brake application

WARNING

A lane-correcting brake application cannot always bring the vehicle back into the original lane. There is a risk of an accident.

Always steer, brake or accelerate yourself, especially if Active Lane Keeping Assist warns you or makes a lane-correcting brake application.

WARNING

Active Lane Keeping Assist does not detect traffic conditions or road users. In very rare cases, the system may make an inappropriate brake application, e.g. after intentionally driving over a solid lane marking. There is a risk of an accident.

An inappropriate brake application may be interrupted at any time if you steer slightly in the opposite direction. Always make sure that there is sufficient distance on the side for other traffic or obstacles.

If you leave your lane, under certain circumstances the vehicle will brake briefly on one side. This is meant to assist you in bringing the vehicle back to the original lane.

This function is available in the range between 40 mph and 120 mph (60 km/h and 200 km/h).

A lane-correcting brake application can only be made after driving over a solid, recognizable lane marking. Before this, a warning must be given by means of intermittent vibration in the steering wheel.

In addition, a lane with lane markings on both sides must be recognized. The brake application also slightly reduces vehicle speed.

If a lane-correcting brake application occurs, the following, for example, appears in the multifunction display:

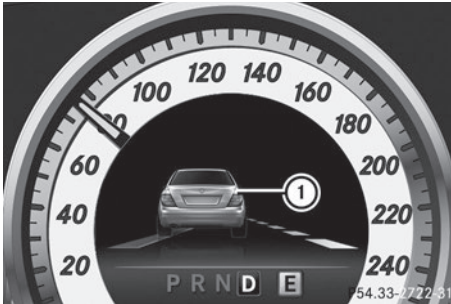

- i** A further lane-correcting brake application can only occur after your vehicle has returned to the original lane.

No lane-correcting brake application occurs if:

- you clearly and actively steer, brake or accelerate.
- you cut the corner on a sharp bend.
- you switch on the turn signals.
- a driving safety system intervenes, e.g. ESP®, PRE-SAFE® Brake or Active Blind Spot Assist.
- you have adopted a sporty driving style with high cornering speeds or high rates of acceleration.
- ESP® is switched off.
- the transmission is not in position **D**.
- a loss of tire pressure or a defective tire has been detected and displayed.

Active Lane Keeping Assist does not detect traffic situations or road users. An inappropriate brake application may be interrupted at any time if you:

- steer slightly in the opposite direction
- use a turn signal
- clearly brake or accelerate

A lane-correcting brake application is interrupted automatically if:

- a driving safety system intervenes, e.g. ESP®, PRE-SAFE® Brake or Active Blind Spot Assist.
- lane markings can no longer be recognized.

Switching on Active Lane Keeping Assist

- ▶ Switch on Active Lane Keeping Assist using the on-board computer; to do so, select **Standard** or **Adaptive** (▷ page 214).

If you drive at speeds above 40 mph (60 km/h) and lane markings are detected, the lines in the assistance graphics display (▷ page 213) are shown in green. Lane Keeping Assist is ready for use.

If **Standard** is selected, no warning vibration occurs if:

- you have switched on the turn signals. In this event, the warnings are suppressed for a certain period of time.
- a driving safety system intervenes, such as ABS, BAS or ESP®.

When **Adaptive** is selected, no warning vibration occurs if:

- you have switched on the turn signals. In this event, the warnings are suppressed for a certain period of time.
- a driving safety system intervenes, e.g. ABS, BAS or ESP®.
- you accelerate hard, e.g. kickdown.
- you brake hard.
- you steer actively, e.g. swerve to avoid an obstacle or change lanes quickly.
- you cut the corner on a sharp bend.

Useful information	204
Important safety notes	204
Displays and operation	204
Menus and submenus	207
Display messages	222
Warning and indicator lamps in the instrument cluster	248

Useful information

- i** This Operator's Manual describes all models and all standard and optional equipment of your vehicle available at the time of publication of the Operator's Manual. Country-specific differences are possible. Please note that your vehicle may not be equipped with all features described. This also applies to safety-related systems and functions.
- i** Read the information on qualified specialist workshops: (> page 25).

Important safety notes

WARNING

If you operate information systems and communication equipment integrated in the vehicle while driving, you will be distracted from traffic conditions. You could also lose control of the vehicle. There is a risk of an accident.

Only operate the equipment when the traffic situation permits. If you are not sure that this is possible, park the vehicle paying attention to traffic conditions and operate the equipment when the vehicle is stationary.

WARNING

If the instrument cluster has failed or malfunctioned, you may not recognize function restrictions in systems relevant to safety. The operating safety of your vehicle may be impaired. There is a risk of an accident.

Drive on carefully. Have the vehicle checked at a qualified specialist workshop immediately.

You must observe the legal requirements for the country in which you are currently driving when operating the on-board computer. The on-board computer only shows messages or warnings from certain systems in the



multifunction display. You should therefore make sure your vehicle is operating safely at all times. Otherwise, a vehicle that is not operating safely may cause an accident. For an overview, see the instrument panel illustration (> page 31).

Displays and operation

Instrument cluster lighting

The lighting in the instrument cluster, in the displays and the controls in the vehicle interior can be adjusted using the brightness control knob.

The brightness control knob is located on the bottom left of the instrument cluster (> page 31).

- ▶ Turn the brightness control knob clockwise or counter-clockwise.
If the light switch is set to **AUTO**,  or , the brightness is dependent upon the brightness of the ambient light.

- i** The light sensor in the instrument cluster automatically controls the brightness of the multifunction display.
In daylight, the displays in the instrument cluster are not illuminated.

Coolant temperature display

WARNING

Opening the hood when the engine is overheated or when there is a fire in the engine compartment could expose you to hot gases or other service products. There is a risk of injury.

Let an overheated engine cool down before opening the hood. If there is a fire in the engine compartment, keep the hood closed and contact the fire department.

The coolant temperature gauge is in the instrument cluster on the left-hand side.

Under normal operating conditions and with the specified coolant level, the coolant temperature may rise to 248 °F (120 °C).

- !** A display message is shown if the coolant temperature is too high.
If the coolant temperature is over 248 °F (120 °C), do not continue driving. The engine will otherwise be damaged.

Tachometer

The red band in the tachometer indicates the engine's overrevving range.

- !** Do not drive in the overrevving range, as this could damage the engine.

The fuel supply is interrupted to protect the engine when the red band is reached.

Outside temperature display

You should pay special attention to road conditions when temperatures are around freezing point.

The outside temperature display is in the multifunction display (▷ page 206).

Changes in the outside temperature are displayed after a short delay.

Speedometer with segments

The segments in the speedometer indicate which speed range is available.

- Cruise control activated (▷ page 171):
The segments light up from the stored speed to the maximum speed.
- DISTRONIC PLUS activated (▷ page 173):
One or two segments in the set speed range light up.
- DISTRONIC PLUS detects a vehicle in front:
The segments between the speed of the vehicle in front and the stored speed light up.

Operating the on-board computer

Overview

The on-board computer is activated as soon as you turn the SmartKey to position **1** in the ignition lock.

You can control the multifunction display and the settings in the on-board computer using the buttons on the multifunction steering wheel.



- ① Multifunction display
- ② Switches on the Voice Control System; see the separate operating instructions
- ③ Right control panel
- ④ Left control panel
- ⑤ Back button

Left control panel

- ◀ • Calls up the menu and menu bar
- ▶

- Press briefly:**
- ▲
 - ▼
 - Scrolls in lists
 - Selects a submenu or function
 - In the **Audio** menu: selects a stored station, an audio track or a video scene
 - In the **Tel** (telephone) menu: switches to the phone book and selects a name or telephone number

- Press and hold:**
- ▲
 - ▼
 - In the **Audio** menu: selects the previous/next station or selects an audio track or a video scene using rapid scrolling
 - In the **Tel** (Telephone) menu: starts rapid scrolling of the phone book if it is open

- OK**
- Confirms a selection/display message
 - In the **Tel** (Telephone) menu: switches to the telephone book and starts dialing the selected number
 - In the **Audio** menu: stops the station search function at the desired station

Right control panel

- 📞 • Rejects or ends a call
- Exits phone book/redial memory
- 📞 • Makes or accepts a call
- Switches to the redial memory

- + • Adjusts the volume
-
- 🔇 • Mute

Back button

- Press briefly:**
- Back
 - Switches off the Voice Control System; see the separate operating instructions
 - Hides display messages/calls up the last **Trip** menu function used
 - Exits the telephone book/redial memory

- Press and hold:**
- Calls up the standard display in the **Trip** menu

Multifunction display

Values and settings as well as display messages are shown in the multifunction display.

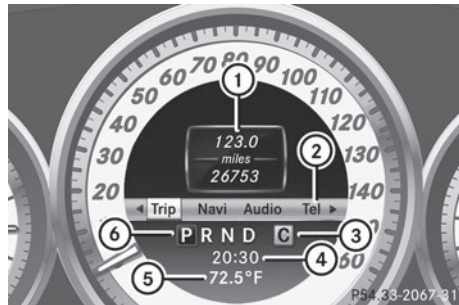

Example: multifunction display for automatic transmission

- ① Text field
- ② Menu bar
- ③ Drive program
- ④ Time

- ⑤ Permanent display: outside temperature or speed (▷ page 216)
- ⑥ Transmission position

▶ **To show menu bar** ②: press the ◀ or ▶ button on the steering wheel.

Menu bar ② disappears after a few seconds.

Text field ① shows the selected menu or submenu as well as display messages.

i You can set the time using the audio system or COMAND, see the separate operating instructions.

The following messages may appear in the multifunction display:

- ↑ Shift recommendation (▷ page 159)
- ◀ P ▶ Parking Guidance (▷ page 188)
- CRUISE** Cruise control (▷ page 171)
-  Adaptive Highbeam Assist (▷ page 118)
- ECO** ECO start/stop function (▷ page 150)
- HOLD** HOLD function (▷ page 182)

Menus and submenus

Menu overview

Operating the on-board computer (▷ page 205).

Depending on the equipment installed in the vehicle, you can call up the following menus:

- **Trip** menu (▷ page 207)
- **Navi** menu (navigation instructions) (▷ page 209)
- **Audio** menu (▷ page 210)
- **Tel** menu (telephone) (▷ page 211)
- **DriveAssist** menu (assistance) (▷ page 213)
- **Serv** menu (▷ page 215)
- **Sett.** menu (settings) (▷ page 215)
- **AMG** menu in AMG vehicles (▷ page 219)

The **Audio**, **Navi** and **Tel** menus differ slightly in vehicles with an audio system and in vehicles with COMAND. The examples given in this Operator's Manual apply to vehicles equipped with COMAND.

Trip menu

Standard display

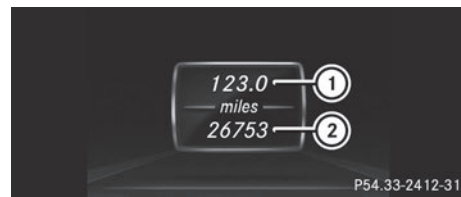

- ▶ Press and hold the ◀ button on the steering wheel until the **Trip** menu with trip odometer ① and odometer ② is shown.

Trip computer "From Start" or "From Reset"

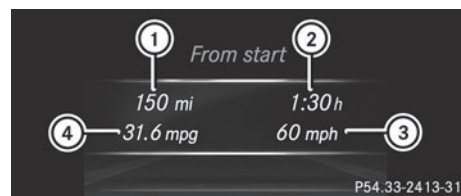

Example: trip computer "From Start"

- ① Distance
- ② Time
- ③ Average speed
- ④ Average fuel consumption

- ▶ Press the ◀ or ▶ button on the steering wheel to select the **Trip** menu.
- ▶ Press the ▲ or ▼ button to select **From Start** or **From Reset**.

The values in the **From Start** submenu are calculated from the start of a journey, whereas the values in the **From Reset** submenu are calculated from the last time the submenu was reset (▷ page 208).

The **From Start** trip computer is automatically reset if:

- the ignition has been switched off for more than four hours.
- 999 hours have been exceeded.
- 9,999 miles have been exceeded.

The **From Reset** trip computer is automatically reset if the value exceeds 9,999 hours or 99,999 miles.

Displaying the range and current fuel consumption

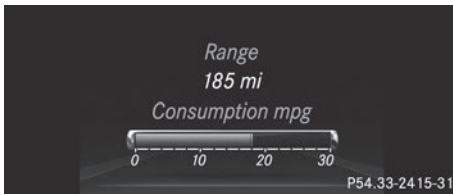

- ▶ Press the or button on the steering wheel to select the **Trip** menu.
- ▶ Press the or button to select the current fuel consumption and the approximate range (except for AMG vehicles).

The approximate range that can be covered depends on the fuel level and your current driving style. If there is only a small amount of fuel left in the fuel tank, the display shows a vehicle being refueled  instead of the range.

ECO display



Example: ECO display

- ▶ Press the or button on the steering wheel to select the **Trip** menu.
- ▶ Press the or button to select **ECO DISPLAY**.

If the ignition remains switched off for longer than four hours, the ECO display will be automatically reset.

Further information on the ECO display ([▷ page 167](#)).

Digital speedometer



① Shift recommendation ([▷ page 159](#))

② Digital speedometer

- ▶ Press the or button on the steering wheel to select the **Trip** menu.
- ▶ Press the or button to select the digital speedometer.

Resetting values



Example: resetting the trip computer "From Start"

- ▶ Press the or button on the steering wheel to select the **Trip** menu.
- ▶ Press the or button to select the function that you wish to reset.
- ▶ Press the button.
- ▶ Press the button to select **Yes** and press the button to confirm.

You can reset the values of the following functions:



- Trip odometer
- "From Start" trip computer
- "From Reset" trip computer
- ECO display

i When you reset the values in the "ECO display", the values in the trip computer "From Start" are likewise reset. When you reset the values in the trip computer "From Start", the values in the "ECO display" are likewise reset.

Navigation system menu

Displaying navigation instructions

In the **Navi** menu, the multifunction display shows navigation instructions. For more information, see the separate operating instructions.

- ▶ Switch on the audio system with Becker® MAP PILOT or COMAND; see the separate operating instructions.
- ▶ Press the  or  button on the steering wheel to select the **Navi** menu.

Route guidance not active

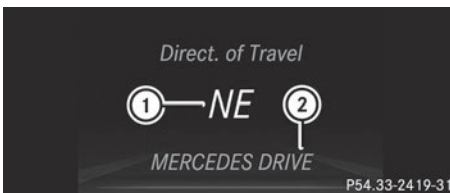

- ① Direction of travel
- ② Current road

Route guidance active

No change of direction announced



- ① Distance to the destination
- ② Distance to the next change of direction
- ③ Current road
- ④ "Follow the road's course" symbol

Change of direction announced without a lane recommendation



- ① Road into which the change of direction leads
- ② Distance to change of direction and visual distance display
- ③ Change-of-direction symbol

When a change of direction is announced, you will see symbol ③ for the change of direction and distance graphic ②. The distance indicator shortens towards the top of the display as you approach the point of the announced change of direction.

Change of direction announced with a lane recommendation

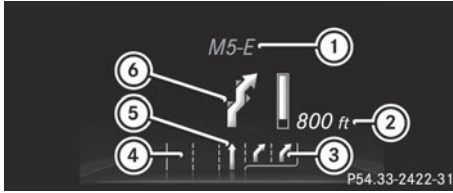

- ① Road into which the change of direction leads
- ② Distance to change of direction and visual distance display
- ③ New lane during a change of direction
- ④ Uninterrupted lane
- ⑤ Lane recommendation
- ⑥ Change-of-direction symbol

On multilane roads, the system can display lane recommendation ⑤ for the next change of direction. During the change of direction, additional lanes may be displayed.

Lane recommendations are only displayed if the relevant data is available on the digital map.

Other status indicators of the navigation system

- : you have reached the destination or an intermediate destination.
- **New Route...** or **Calculating Route:** calculating a new route
- **Off Map** or **Off Mapped Road:** the vehicle position is outside the area of the digital map (off-map position).
- **No Route:** no route could be calculated to the selected destination.

Audio menu

Selecting a radio station



- ① Waveband
- ② Station frequency with memory position

i Station ② is displayed with the station frequency or station name. The memory position is only displayed along with station ② if this has been stored.

- ▶ Switch on the audio system or COMAND and select Radio (see the separate operating instructions).
- ▶ Press the or button on the steering wheel to select the **Audio** menu.
- ▶ **To select a stored station:** briefly press the or button.
- ▶ **To select a station from the station list:** press and briefly hold the or button.

If no station list is received:

- ▶ **To select a station using the station search:** press and briefly hold the or button.

i SIRIUS XM satellite radio functions like a normal radio.

For more information on satellite radio operation, see the separate operating instructions.

i For information on switching waveband and storing stations; see the separate operating instructions.

Operating an audio player or audio media



Example: CD/DVD changer display

① Current title

Audio data from various audio devices or media can be played, depending on the equipment installed in the vehicle.

- ▶ Switch on the audio system or COMAND and select the audio player or medium, see the separate operating instructions.
- ▶ Press the ◀ or ▶ button on the steering wheel to select the **Audio** menu.
- ▶ **To select the next/previous track:** briefly press the ▲ or ▼ button.
- ▶ **To select a track from the track list (rapid scrolling):** press and hold the ▲ or ▼ button until desired track has been reached.

If you press and hold ▲ or ▼, the rapid scrolling speed is increased. Not all audio drives or data carriers support this function. If track information is stored on the audio device or medium, the multifunction display will show the number and name of the track. The current track does not appear in audio AUX mode (**A**uxiliary audio mode: external audio source connected).

Video DVD operation



Example: CD/DVD changer display

① Current scene

- ▶ Switch on COMAND and select video DVD; see the separate operating instructions.
- ▶ Press the ◀ or ▶ button on the steering wheel to select the **Audio** menu.
- ▶ **To select the next/previous scene:** briefly press the ▲ or ▼ button.
- ▶ **To select a scene from the scene list (rapid scrolling):** press and hold the ▲ or ▼ button until desired scene has been reached.

Telephone menu



Introduction

WARNING

If you operate information systems and communication equipment integrated in the vehicle while driving, you will be distracted from traffic conditions. You could also lose control of the vehicle. There is a risk of an accident.

Only operate the equipment when the traffic situation permits. If you are not sure that this is possible, park the vehicle paying attention to traffic conditions and operate the equipment when the vehicle is stationary.

When telephoning, you must observe the legal requirements for the country in which you are currently driving.

- ▶ Switch on your mobile phone and audio system or COMAND, see the separate operating instructions.
- ▶ Establish a Bluetooth® connection to the audio system or COMAND; see the separate operating instructions.
- ▶ Press the  or  button on the steering wheel to select the **Te1** menu.

You will see one of the following display messages in the multifunction display:

- **Phone READY** or the name of the network provider: the mobile phone has found a network and is ready to receive.
- **Phone No Service**: there is no network available or the mobile phone is searching for a network.

Accepting a call

If someone calls you when you are in the **Te1** menu, a display message appears in the multifunction display, for example:

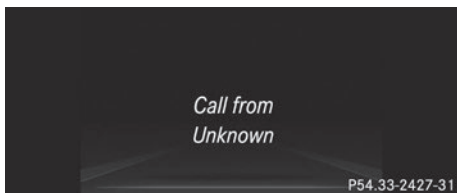

Example: incoming call

- ▶ Press the  button on the steering wheel to accept an incoming call.







You can accept a call even if you are not in the **Te1** menu.

Rejecting or ending a call





- ▶ Press the  button on the steering wheel.

You can end or reject a call even if you are not in the **Te1** menu.







Dialing an entry from the phone book

- ▶ Press the  or  button on the steering wheel to select the **Te1** menu.
- ▶ Press the ,  or  button to switch to the phone book.
- ▶ Press the  or  button to select the desired name.



or

- ▶ **To begin rapid scrolling:** press and hold the  or  button for longer than one second. Rapid scrolling stops when you release the button or reach the end of the list.
- ▶ **If only one telephone number is stored for a name:** press the  or  button to start dialing.

or







- ▶ **If there is more than one number for a particular name:** press the  or  button to display the numbers.
- ▶ Press the ,  button to select the number you want to dial.
- ▶ Press the  or  button to start dialing.

or



- ▶ **To exit the telephone book:** press the  or  button.

Redialing

The on-board computer saves the last names or numbers dialed in the redial memory.

- ▶ Press the  or  button on the steering wheel to select the **Te1** menu.
- ▶ Press the  button to switch to the redial memory.
- ▶ Press the ,  button to select the desired name or number.
- ▶ Press the  or  button to start dialing.

or

- ▶ **If you do not want to make a call:** press the  or  button.

Assistance menu

Introduction



In the **DriveAssist** menu, you have the following options:

- Displaying the assistance graphic (▷ page 213)
- Activating/deactivating ESP® (▷ page 213)
- Activating/deactivating PRE-SAFE® Brake (▷ page 214)
- Activating/deactivating ATTENTION ASSIST (▷ page 214)
- Activating/deactivating Blind Spot Assist or Active Blind Spot Assist (▷ page 214)
- Activating/deactivating Lane Keeping Assist or Active Lane Keeping Assist (▷ page 214)

Displaying the assistance graphic

- ▶ Press the or button on the steering wheel to select the **DriveAssist** menu.
- ▶ Press or to select **Assistance Graphic**.
- ▶ Press the button.

The multifunction display shows the DISTRONIC PLUS distance display in the assistance graphic (▷ page 179).

The assistance graphic can display the status of and information from other driving systems or driving safety systems.

The assistance graphic shows:

- the symbol when ATTENTION ASSIST (▷ page 192) is deactivated.
- the lane markings as bright lines when Lane Keeping Assist (▷ page 194) or Active Lane Keeping Assist (▷ page 199) is activated.
- the symbol when PRE-SAFE® Brake (▷ page 71) is deactivated.

Deactivating/activating ESP®

- ❗ Observe the "Important safety notes" section in the description of ESP (▷ page 68).

WARNING

If you deactivate ESP®, ESP® no longer stabilizes the vehicle. There is an increased risk of skidding and an accident.

Only deactivate ESP® in the situations described in the following.

It may be best to deactivate ESP® in the following situations:



- when using snow chains
- in deep snow
- on sand or gravel

Activating/deactivating ESP® on AMG vehicles (▷ page 69).

For further information about ESP®, see (▷ page 68).

- ▶ Start the engine.
- ▶ Press the or button on the steering wheel to select the **DriveAssist** menu.
- ▶ Press the or button to select **ESP**.
- ▶ Press the button.
- ▶ **To deactivate:** press again. The warning lamp in the instrument cluster lights up.
- ▶ **To activate:** press again. The warning lamp in the instrument cluster goes out.

ESP® is deactivated if the  warning lamp in the instrument cluster lights up continuously when the engine is running.







If the  warning lamp and the  warning lamp are lit continuously, ESP® is not available due to a malfunction.

Observe the information on warning lamps (▷ page 252).

Observe the information on display messages (▷ page 223).

Activating/deactivating PRE-SAFE® Brake

PRE-SAFE® Brake is only available in vehicles with DISTRONIC PLUS.

- ▶ Press the  or  button on the steering wheel to select the **DriveAssist** menu.
- ▶ Press the  or  button to select **PRE-SAFE Brake**.
- ▶ Press the  button.
The current selection is displayed.
- ▶ **To activate/deactivate:** press the  button again.





When PRE-SAFE® Brake is deactivated, the assistance graphic shows the  symbol in the multifunction display.



If the **PRE-SAFE Brake: Sensors Deactivated** message appears, the radar sensor system is deactivated.

- ▶ Switch on the radar sensor system (▷ page 218).

For more information on PRE-SAFE® Brake, see (▷ page 71).







Activating/deactivating ATTENTION ASSIST

- ▶ Press the  or  button on the steering wheel to select the **DriveAssist** menu.
- ▶ Press the  or  button to select **Attention Assist**.

- ▶ Press the  button.
The current selection is displayed.
- ▶ **To activate/deactivate:** press the  button again.
When ATTENTION ASSIST is deactivated, the  symbol appears in the multifunction display in the assistance graphics display.

For further information about ATTENTION ASSIST, see (▷ page 192).

Activating/deactivating Blind Spot Assist

- ▶ Press the  or  button on the steering wheel to select the **DriveAssist** menu.
- ▶ Press the  or  button to select **Blind Spot Assist**.
- ▶ Press the  button.
The current selection is displayed.
- ▶ **To activate/deactivate:** press the  button again.







If the **Blind Spot Assist Sensors Deactivated** or **Act. Blind Spot Asst. Sensors Deactivated** message appears, the radar sensor system is deactivated.



- ▶ Switch on the radar sensor system (▷ page 218).

For further information about Blind Spot Assist, see (▷ page 193).

For further information about Active Blind Spot Assist, see (▷ page 196).

Activating/deactivating Lane Keeping Assist

- ▶ Press the  or  button on the steering wheel to select the **DriveAssist** menu.
- ▶ Press the  or  button to select **Lane Keep. Asst.**
- ▶ Press the  button.
The current selection is displayed.
- ▶ Press  to confirm.

- ▶ Press the  or  button to set **Off**, **Standard** or **Adaptive**.
- ▶ Press the  button to save the setting. When Lane Keeping Assist or Active Lane Keeping Assist is activated, the multifunction display shows the lane markings as bright lines in the assistance graphic.

For further information about Lane Keeping Assist, see (▷ page 194).

For further information about Active Lane Keeping Assist, see (▷ page 199).

Maintenance menu



In the **Service** menu, you have the following options:

- Calling up display messages (▷ page 222)
- Restarting the tire pressure loss warning system (Canada only) (▷ page 321)
- Checking the tire pressure electronically (▷ page 322)
- Calling up the service due date (▷ page 286)

Settings menu

Introduction



In the **Settings** menu, you have the following options:









- Changing the instrument cluster settings (▷ page 215)
- Changing the light settings (▷ page 216)
- Changing the vehicle settings (▷ page 217)
- Changing the convenience settings (▷ page 218)
- Restoring the factory settings (▷ page 219)

Instrument cluster

Selecting the unit of measurement for distance

The **Display Unit Speed-/Odometer:** function allows you to choose whether certain displays appear in kilometers or miles in the multifunction display.

You can determine whether the multifunction display shows some messages in miles or kilometers.

- ▶ Press the  or  button on the steering wheel to select the **Sett.** menu.
- ▶ Press the  or  button to select the **Instr. Cluster** submenu.
- ▶ Press  to confirm.
- ▶ Press the  or  button to select the **Display Unit Speed-/Odometer:** function. You will see the selected setting: **km** or **miles**.
- ▶ Press the  button to save the setting.









The selected unit of measurement for distance applies to:

- the digital speedometer in the **Trip** menu
- the odometer and the trip odometer
- the trip computer
- current consumption and the range
- the navigation instructions in the **Navi** menu
- cruise control

- DISTRONIC PLUS
- ASSYST PLUS service interval display

Selecting the permanent display function









You can determine whether the multifunction display permanently shows your speed or the outside temperature.

- ▶ Press the  or  button on the steering wheel to select the **Settings** menu.
- ▶ Press the  or  button to select the **Instrument Cluster** submenu.
- ▶ Press  to confirm.
- ▶ Press the  or  button to select the **Permanent Display:** function.
You will see the selected setting **Outside Temperature** or **Additional Speedometer [km/h]/Additional Speedometer [mph]**.
- ▶ Press the  button to save the setting.

Lights









Switching the daytime running lamps on/off

Daytime running lamps are required by law (Canada only). You cannot set the "daytime running lamps" function via the on-board computer.

- ▶ Press the  or  button on the steering wheel to select the **Sett.** menu.
- ▶ Press the  or  button to select the **Lights** submenu.
- ▶ Press  to confirm.
- ▶ Press the  or  button to select the **Day Lights** function.
If the **Day Lights** function has been switched on, the cone of light and the  symbol in the multifunction display are shown in orange.
- ▶ Press the  button to save the setting.









Further information on daytime running lamps (▷ page 115).

Switching Adaptive Highbeam Assist on/off

- ▶ Press the  or  button on the steering wheel to select the **Sett.** menu.
- ▶ Press the  or  button to select the **Lights** submenu.
- ▶ Press  to confirm.
- ▶ Press the  or  button to select the **Adapt. Highbeam** function.
If the **Adapt. Highbeam** function has been switched on, the cone of light and the  symbol in the multifunction display are shown in orange.
- ▶ Press the  button to save the setting.

For further information about Adaptive Highbeam Assist, see (▷ page 118).

Activating/deactivating surround lighting and exterior lighting delayed switch-off

- ▶ Press the  or  button on the steering wheel to select the **Settings** menu.
- ▶ Press the  or  button to select the **Lights** submenu.
- ▶ Press  to confirm.
- ▶ Press the  or  button to select the **Surround Lighting** function.
When the **Surround Lighting** function is activated, the light cone and the area around the vehicle are displayed in orange in the multifunction display.
- ▶ Press the  button to save the setting.

Deactivating delayed switch-off of the exterior lighting temporarily:

- ▶ Before leaving the vehicle, turn the SmartKey to position **0** in the ignition lock.
- ▶ Turn the SmartKey to position **2** in the ignition lock.
The exterior lighting delayed switch-off is deactivated.

Delayed switch-off of the exterior lighting is reactivated the next time you start the engine.

If you have activated the **Surround Lighting** function and the light switch is set to **AUTO**, the following functions are activated when it is dark:







- **surround lighting:** the exterior lighting remains lit for 40 seconds after unlocking with the SmartKey. If you start the engine, the surround lighting is switched off and automatic headlamp mode is activated (▷ page 115).
- **exterior lighting delayed switch-off:** the exterior lighting remains lit for 60 seconds after the engine is switched off. If you close all the doors and the trunk lid, the exterior lighting goes off after 5 seconds.

i Depending on your vehicle's equipment, when the surround lighting and delayed switch-off exterior lighting are on, the following light up:

- Parking lamps
- Front fog lamps
- Low-beam headlamps
- Daytime running lamps
- Side marker lamps
- Surround lighting in the exterior mirrors

Activating/deactivating the interior lighting delayed switch-off

If you activate the **Interior Lighting Delay** function, the interior lighting remains on for 20 seconds after you remove the SmartKey from the ignition lock.







- ▶ Press the  or  button on the steering wheel to select the **Sett** menu.
- ▶ Press the  or  button to select the **Lights** submenu.
- ▶ Press **OK** to confirm.
- ▶ Press the  or  button to select the **Interior Lighting Delay** function. If the **Interior Lighting Delay** function has been switched on, the vehicle interior

is displayed in orange in the multifunction display.

- ▶ Press the **OK** button to save the setting.

Vehicle

Activating/deactivating the automatic door locking mechanism







- ▶ Press the  or  button on the steering wheel to select the **Sett.** menu.
- ▶ Press the  or  button to select the **Vehicle** submenu.
- ▶ Press **OK** to confirm.
- ▶ Press the  or  button to select the **Auto. Door Locks** function. When the **Auto. Door Locks** function is activated, the vehicle doors are displayed in orange in the multifunction display.
- ▶ Press the **OK** button to save the setting.

If you activate the **Auto. Door Locks** function, the vehicle is centrally locked above a speed of around 9 mph (15 km/h).









For further information on the automatic locking feature, see (▷ page 83).

Activating/deactivating the acoustic locking verification signal

If you switch on the **Acoustic Lock** function, an acoustic signal sounds when you lock the vehicle.

- ▶ Press the  or  button on the steering wheel to select the **Sett.** menu.
- ▶ Press the  or  button to select the **Vehicle** submenu.
- ▶ Press **OK** to confirm.
- ▶ Press the  or  button to select the **Acoustic Lock** function. If the **Acoustic Lock** function is activated, the  symbol in the multifunction display lights up orange.
- ▶ Press the **OK** button to save the setting.

Activating/deactivating the radar sensor system

- ▶ Press the  or  button on the steering wheel to select the **Sett.** menu.
- ▶ Press the  or  button to select the **Vehicle** submenu.
- ▶ Press  to confirm.
- ▶ Press the  or  button to select **Radar Sensor (See Oper. Manual):**. You will see the selected setting: **Enabled** or **Disabled**.
- ▶ Press the  button to save the setting.

The following systems are switched off when the radar sensor system is deactivated:

- DISTRONIC PLUS (▷ page 173)
- BAS PLUS (▷ page 66)
- PRE-SAFE® Brake (▷ page 71)
- Blind Spot Assist (▷ page 193)
- Active Blind Spot Assist (▷ page 196)

Convenience

Activating/deactivating the EASY-ENTRY/EXIT feature

WARNING









When the EASY-ENTRY/EXIT feature adjusts the steering wheel, you and other vehicle occupants – particularly children – could become trapped. There is a risk of injury.

While the EASY-ENTRY/EXIT feature is making adjustments, make sure that no one has any body parts in the sweep of the steering wheel.

If somebody becomes trapped:









- press one of the memory function position buttons, or
- move the switch for steering wheel adjustment in the opposite direction to that in which the steering wheel is moving.

The adjustment process is stopped.

- ▶ Press the  or  button on the steering wheel to select the **Sett.** menu.
- ▶ Press the  or  button to select the **Convenience** submenu.
- ▶ Press  to confirm.
- ▶ Press the  or  button to select the **Easy Entry/Exit** function. If the **Easy Entry/Exit** function is activated, the vehicle steering wheel is displayed in orange in the multifunction display.
- ▶ Press the  button to save the setting.

Further information on the EASY-ENTRY/EXIT feature (▷ page 106).

Switching the belt adjustment on/off

- ▶ Press the  or  button on the steering wheel to select the **Sett.** menu.
- ▶ Press the  or  button to select the **Convenience** submenu.
- ▶ Press  to confirm.
- ▶ Press the  or  button to select the **Belt Adjustment** function. When the **Belt Adjustment** function is activated, the vehicle seat belt is displayed in orange in the multifunction display.
- ▶ Press the  button to save the setting.





For further information on belt adjustment, see (▷ page 56).

Switching the fold-in mirrors with the locking feature on/off

This function is only available on vehicles with the memory function (▷ page 110).

This function is only available in Canada.

When you activate the **Auto. Mirror Folding** function, the exterior mirrors are folded in when the vehicle is locked. If you unlock the vehicle and then open a door, the exterior mirrors fold out again.

- ▶ Press the  or  button on the steering wheel to select the **Sett.** menu.
- ▶ Press the  or  button to select the **Convenience** submenu.

- ▶ Press **OK** to confirm.
- ▶ Press the **▼** or **▲** button to select the **Auto. Mirror Folding** function.
If the **Auto. Mirror Folding** function is activated, the vehicle's exterior mirror is displayed in orange in the multifunction display.
- ▶ Press the **OK** button to save the setting.

If you have switched the **Auto. Mirror Folding** function on and you fold the exterior mirrors in using the button on the door (▷ page 108), they will not fold out automatically. The exterior mirrors can then only be folded out using the button on the door.

Restoring the factory settings

- ▶ Press the **◀** or **▶** button on the steering wheel to select the **Sett.** menu.
- ▶ Press the **▼** or **▲** button to select the **Factory Setting** submenu.
- ▶ Press **OK** to confirm.
The **Reset All Settings?** message appears.
- ▶ Press the **▼** or **▲** button to select **No** or **Yes**.
- ▶ Press the **OK** button to confirm the selection.
If you have selected **Yes**, the multifunction display shows a confirmation message.

For safety reasons, the **Day Lights** function in the **Lights** submenu is only reset if the vehicle is stationary.

AMG menu in AMG vehicles

AMG displays

- ▶ Press **◀** or **▶** on the steering wheel to select the **AMG** menu.



- ① Digital speedometer
- ② Gear indicator
- ③ Upshift indicator
- ④ Engine oil temperature
- ⑤ Coolant temperature

Upshift indicator **UP** ③ indicates that the engine has reached the overrevving range when in the manual gearshift program. Upshift indicator **UP** ③ fades out other messages until you have shifted up.

If the engine oil temperature is below 176 °F (80 °C) the oil temperature is shown in blue. Avoid driving at full engine output during this time.

SETUP

SETUP shows the drive program, the ESP® (Electronic Stability Program) mode and the SPORT handling mode.

- ▶ Press **◀** or **▶** on the steering wheel to select the **AMG** menu.
- ▶ Press the **▲** button repeatedly until SETUP is displayed.

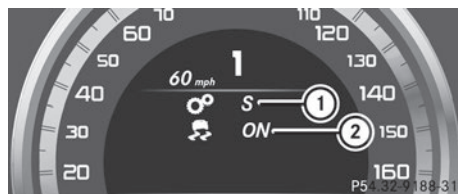



- ① Drive program (**C/SS+/M**)
- ② ESP® mode (**ON/OFF**) or SPORT handling mode (**SPORT**)



RACETIMER

Displaying and starting RACETIMER

The RACETIMER is only intended for use on a closed race circuit. Do not use the function on public roads.

You can use the RACETIMER to store lap times.

- ▶ Press  or  on the steering wheel to select the **AMG** menu.
- ▶ Press the  button repeatedly until the RACETIMER is shown.

- i** If the RACETIMER is selected, the  and  buttons cannot be used to call up the menu bar.





- ① Lap
- ② RACETIMER

You can start the RACETIMER when the engine is running or if the SmartKey is in position **2** in the ignition lock.

- ▶ **To start:** press the  button to start the RACETIMER.

Displaying the intermediate time



- ▶ Press the  or  button to select **Interm. Time**.
- ▶ Press  to confirm.
The intermediate time is displayed for five seconds.

Starting a new lap

- ▶ Press  to confirm **New Lap**.



- ① RACETIMER
- ② Fastest lap time (best lap)
- ③ Lap

- i** It is possible to store a maximum of sixteen laps. The 16th lap can only be completed with **Finish Lap**.

Stopping the RACETIMER



- ▶ Press the  button on the steering wheel.



- ▶ Press  to confirm **Yes**.

The RACETIMER interrupts timing when you stop the vehicle and turn the SmartKey to position **1** in the ignition lock. If you turn the key to position **2** or **3** and then press  to confirm **Start**, timing is continued.

Resetting the current lap

- ▶ Stop the RACETIMER.
- ▶ Press the  or  button to select **Reset Lap**.
- ▶ Press  to reset the lap time to "0".

Deleting all laps

If you switch off the engine, the RACETIMER is reset to "0" after 30 seconds. All laps are deleted.

You cannot delete individual stored laps. If you have stopped 16 laps, the current lap does not have to be reset.

- ▶ Reset the current lap.
- ▶ Press to confirm **Reset**.
Reset Race-Timer? appears in the multifunction display.



- ▶ Press the button to select **Yes** and press the button to confirm. All laps are deleted.

Overall statistics

This function is shown if you have stored at least one lap and stopped the RACETIMER.

- ▶ Press or on the steering wheel to select the **AMG** menu.
- ▶ Press the button repeatedly until the overall evaluation is shown.

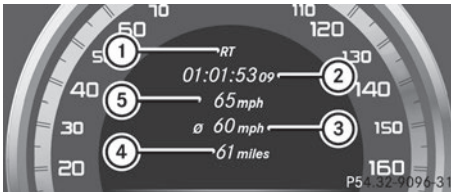

- ① RACETIMER overall evaluation
- ② Total time driven
- ③ Average speed
- ④ Distance covered
- ⑤ Maximum speed

Lap statistics

This function is only available if you have stored at least two laps and have stopped the RACETIMER.

- ▶ Press or on the steering wheel to select the **AMG** menu.
- ▶ Press the button repeatedly until the lap evaluation is shown. Each lap is shown in a separate submenu. The fastest lap is indicated by flashing symbol ①.

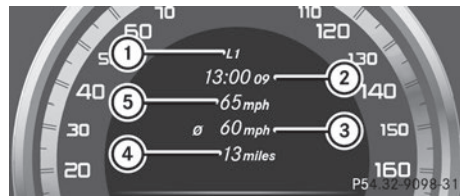

- ① Lap
- ② Lap time
- ③ Average lap speed
- ④ Lap length
- ⑤ Top speed during lap
- ▶ Press the or button to select a different lap evaluation.

Display messages

General notes

Display messages appear in the multifunction display.

Display messages with graphic displays may be shown in simplified form in the Operator's Manual and may therefore differ from the multifunction display.



Please respond in accordance with the display messages and follow the additional notes in this Operator's Manual.

Certain display messages are accompanied by an audible warning tone or a continuous tone.

When the ignition is switched off, all display messages are deleted, apart from some high-priority display messages. Once the causes of the high-priority display messages have been rectified, the corresponding display messages are also deleted.

When you stop and park the vehicle, please observe the notes on the HOLD function (> page 182) and parking (> page 164).

Hiding display messages







- ▶ Press the  or  button on the steering wheel to hide the display message. The display message is cleared.







The multifunction display shows high-priority display messages in red. Some high-priority display messages cannot be hidden.







The multifunction display shows these messages continuously until the causes for the messages have been remedied.









Message memory

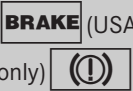

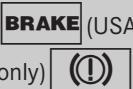
The **message memory** allows you to call up previous display messages.









- ▶ Press the  or  button on the steering wheel to select the **Serv.** menu. If there are display messages, the multifunction display shows **2 messages**, for example.
- ▶ Press the  or  button to select the entry, e.g. **2 messages**.
- ▶ Press  to confirm.
- ▶ Press the  or  button to scroll through the display messages.

Safety systems	
Display messages	Possible causes/consequences and ► Solutions
 <p>Currently Unavailable See Operator's Manual</p>	<p>ABS (Anti-lock Braking System), ESP® (Electronic Stability Program), BAS (Brake Assist), PRE-SAFE®, the HOLD function and hill start assist are temporarily unavailable.</p> <p>BAS PLUS and PRE-SAFE® Brake may also have failed.</p> <p>In addition, the ,  and  warning lamps light up in the instrument cluster.</p> <p>ATTENTION ASSIST is deactivated.</p> <p>Possible causes are:</p> <ul style="list-style-type: none"> • self-diagnosis is not yet complete. • the on-board voltage may be insufficient. <p>⚠ WARNING</p> <p>The brake system continues to function normally, but without the functions listed above. The wheels could therefore lock if you brake hard, for example.</p> <p>The steerability and braking characteristics may be severely affected. The braking distance in an emergency braking situation can increase.</p> <p>If ESP® is not operational, ESP® is unable to stabilize the vehicle. There is an increased risk of skidding and an accident.</p> <p>► Carefully drive a suitable distance, making slight steering movements at a speed above 12 mph (20 km/h). If the display message disappears, the functions mentioned above are available again.</p> <p>If the display message continues to be displayed:</p> <ul style="list-style-type: none"> ► Drive on carefully. ► Visit a qualified specialist workshop.
 <p>Inoperative See Operator's Manual</p>	<p>ESP®, BAS, PRE-SAFE®, the HOLD function and hill start assist are unavailable due to a malfunction.</p> <p>BAS PLUS and PRE-SAFE® Brake may also have failed.</p> <p>In addition, the , and  warning lamps light up in the instrument cluster.</p> <p>The self-diagnosis function might not be complete, for example. ATTENTION ASSIST is deactivated.</p> <p>⚠ WARNING</p> <p>The brake system continues to function normally, but without the functions listed above.</p>

Display messages	Possible causes/consequences and ► Solutions
	<p>The braking distance in an emergency braking situation can thus increase.</p> <p>If ESP® is not operational, ESP® is unable to stabilize the vehicle. There is an increased risk of skidding and an accident.</p> <p>► Carefully drive a suitable distance, making slight steering movements at a speed above 12 mph (20 km/h). If the display message disappears, the functions mentioned above are available again.</p> <p>If the display message continues to be displayed:</p> <p>► Drive on carefully. ► Visit a qualified specialist workshop.</p>
<div style="display: flex; align-items: center;"> <div style="border: 1px solid black; padding: 2px; margin-right: 5px;">EBD</div> <div style="border: 1px solid black; padding: 2px; margin-right: 5px;"></div> <div style="border: 1px solid black; padding: 2px; margin-right: 5px;"></div> </div> <p>Inoperative See Operator's Manual</p>	<p>EBD (electronic brake force distribution), ABS, ESP®, BAS, PRE-SAFE®, the HOLD function and hill start assist are unavailable due to a malfunction.</p> <p>BAS PLUS and PRE-SAFE® Brake may also have failed.</p> <p>In addition, the ,  and  warning lamps light up in the instrument cluster and a warning tone sounds.</p> <p>⚠ WARNING</p> <p>The brake system continues to function normally, but without the functions listed above. The front and rear wheels could therefore lock if you brake hard, for example.</p> <p>The steerability and braking characteristics may be severely affected. The braking distance in an emergency braking situation can increase.</p> <p>If ESP® is not operational, ESP® is unable to stabilize the vehicle. There is an increased risk of skidding and an accident.</p> <p>► Drive on carefully. ► Visit a qualified specialist workshop immediately.</p>
<div style="display: flex; align-items: center;"> <div style="border: 1px solid black; padding: 2px; margin-right: 5px;">PARK</div> <div style="margin-right: 5px;">(USA only)</div> <div style="border: 1px solid black; padding: 2px; margin-right: 5px;"></div> <div style="margin-right: 5px;">(Canada only)</div> </div> <p>Please Release Parking Brake</p>	<p>You are driving with the parking brake applied. A warning tone also sounds.</p> <p>► Release the parking brake.</p>

Display messages	Possible causes/consequences and ► Solutions
<p> (USA only)  (Canada only)</p> <p>Brake Immediately</p>	<p>A malfunction has occurred while the HOLD function or DISTRONIC PLUS is active.</p> <p>A tone may also sound at regular intervals. If you attempt to lock the vehicle, the tone becomes louder.</p> <p>You cannot start the engine.</p> <ul style="list-style-type: none"> ► Paying attention to the traffic situation, immediately depress the brake pedal firmly and hold until the display message disappears. ► Use the folding wheel chock (► page 339) from the vehicle tool kit to secure the vehicle against rolling away. You can restart the engine.
<p> (USA only)  (Canada only)</p> <p>Check Brake Fluid Level</p>	<p>There is not enough brake fluid in the brake fluid reservoir. In addition, the  (USA only)/ (Canada only) warning lamp lights up in the instrument cluster and a warning tone sounds.</p> <p> WARNING</p> <p>The braking effect may be impaired. There is a risk of an accident.</p> <ul style="list-style-type: none"> ► Pull over and stop the vehicle safely as soon as possible, paying attention to road and traffic conditions. Do not continue driving under any circumstances. ► Secure the vehicle against rolling away (► page 164). ► Consult a qualified specialist workshop. ► Do not add brake fluid. This does not correct the malfunction.
<p></p> <p>Check Brake Pad Wear</p>	<p>The brake pads/linings have reached their wear limit.</p> <ul style="list-style-type: none"> ► Visit a qualified specialist workshop.
<p></p> <p>Inoperative</p>	<p>One or more main features of the mbrace system are malfunctioning.</p> <ul style="list-style-type: none"> ► Have the mbrace system checked immediately at a qualified specialist workshop.
<p>PRE-SAFE Inoperative See Operator's Manual</p>	<p>Important functions of PRE-SAFE® have failed. All other occupant safety systems, e.g. air bags, remain available.</p> <ul style="list-style-type: none"> ► Visit a qualified specialist workshop immediately.

Display messages	Possible causes/consequences and ► Solutions
<p>PRE-SAFE Functions Currently Limited See Operator's Manual</p>	<p>PRE-SAFE® Brake is temporarily inoperative. Possible causes are:</p> <ul style="list-style-type: none"> • function is impaired due to heavy rain or snow. • the sensors in the radiator grill and the bumper are dirty. • the radar sensor system is temporarily inoperative, e.g. due to electromagnetic radiation emitted by nearby TV or radio stations or other sources of electromagnetic radiation. • AMG vehicles: ESP® is deactivated. • the system is outside the operating temperature range. • the on-board voltage is too low. <p>When the causes stated above no longer apply, the display message disappears.</p> <p>PRE-SAFE® Brake is operational again.</p> <p>If the display message does not disappear:</p> <ul style="list-style-type: none"> ► Pull over and stop the vehicle safely as soon as possible, paying attention to road and traffic conditions. ► Secure the vehicle against rolling away (▷ page 164). ► Clean the sensors in the radiator grill and the bumper (▷ page 295). ► Restart the engine. ► AMG vehicles: reactivate ESP® (▷ page 69).
<p>PRE-SAFE Functions Limited See Operator's Manual</p>	<p>PRE-SAFE® Brake is inoperative due to a malfunction. BAS PLUS or the distance warning signal may also have failed.</p> <ul style="list-style-type: none"> ► Visit a qualified specialist workshop.
<p> SRS Malfunction Service Required</p>	<p>There is a malfunction in the SRS (Supplemental Restraint System). The  warning lamp also lights up in the instrument cluster.</p> <p>⚠ WARNING</p> <p>The air bags or Emergency Tensioning Devices may either be triggered unintentionally or, in the event of an accident, may not be triggered.</p> <p>There is an increased risk of injury.</p> <ul style="list-style-type: none"> ► Visit a qualified specialist workshop. <p>For further information about SRS, see (▷ page 41).</p>

Display messages	Possible causes/consequences and ► Solutions
 <p>Front Left Malfunction Service Required or Front Right Malfunction Service Required</p>	<p>SRS has malfunctioned at the front on the left or right. The  warning lamp also lights up in the instrument cluster.</p> <p>⚠ WARNING</p> <p>The air bags or Emergency Tensioning Devices may either be triggered unintentionally or, in the event of an accident, may not be triggered.</p> <p>There is an increased risk of injury.</p> <p>► Visit a qualified specialist workshop.</p>
 <p>Rear Left Malfunction Service Required or Rear Right Malfunction Service Required</p>	<p>⚠ WARNING</p> <p>The air bags or Emergency Tensioning Devices may either be triggered unintentionally or, in the event of an accident, may not be triggered.</p> <p>There is an increased risk of injury.</p> <p>SRS has malfunctioned at the rear on the left or right. The  warning lamp also lights up in the instrument cluster.</p> <p>► Visit a qualified specialist workshop.</p>
 <p>Rear Center Malfunction Service Required</p>	<p>⚠ WARNING</p> <p>The air bags or Emergency Tensioning Devices may either be triggered unintentionally or, in the event of an accident, may not be triggered.</p> <p>There is an increased risk of injury.</p> <p>SRS has malfunctioned at the rear center. The  warning lamp also lights up in the instrument cluster.</p> <p>► Visit a qualified specialist workshop.</p>
 <p>Left Side Curtain Airbag Malfunction Service Required or Right Side Curtain Airbag Malfunction Service Required</p>	<p>There is a malfunction in the left-hand or right-hand window curtain air bag.</p> <p>The  warning lamp also lights up in the instrument cluster.</p> <p>⚠ WARNING</p> <p>The left or right window curtain air bag may either be triggered unintentionally or, in the event of an accident, may not be triggered.</p> <p>There is an increased risk of injury.</p> <p>► Visit a qualified specialist workshop.</p>

Display messages	Possible causes/consequences and ► Solutions
<p>Front Passenger Airbag Disabled See Operator's Manual</p>	<p>The front-passenger air bag is disabled during the journey, even though:</p> <ul style="list-style-type: none"> • an adult or • a person larger than a certain size is occupying the front-passenger seat <p>If additional forces are applied to the seat, the system may interpret the occupant's weight as lower than it actually is.</p> <p> WARNING</p> <p>The front-passenger air bag does not deploy during an accident. There is an increased risk of injury.</p> <ul style="list-style-type: none"> ► Pull over and stop the vehicle safely as soon as possible, paying attention to road and traffic conditions. ► Secure the vehicle against rolling away (▷ page 164). ► Switch the ignition off. ► Have the occupant get out of the vehicle. ► Keep the seat unoccupied, close the front-passenger door and switch on the ignition. ► Observe the PASSENGER AIR BAG OFF indicator lamp in the center console and the multifunction display and check the following: <p>Seat unoccupied and ignition switched on:</p> <ul style="list-style-type: none"> • the PASSENGER AIR BAG OFF indicator lamp must light up and remain lit. If the indicator lamp is on, OCS has disabled the front-passenger air bag (▷ page 47). • the Front Passenger Airbag Enabled See Operator's Manual or Front Passenger Airbag Disabled See Operator's Manual display messages must not be shown in the multifunction display. <ul style="list-style-type: none"> ► Wait for a period of at least 60 seconds until the necessary system checks have been completed. ► Make sure that the display messages do not appear in the multifunction display. <p>If these conditions are fulfilled, the front-passenger seat can be occupied again. Whether the PASSENGER AIR BAG OFF indicator lamp remains lit or goes out depends on how OCS classifies the occupant.</p> <p>If the conditions are not fulfilled, the system is not operating correctly.</p> <ul style="list-style-type: none"> ► Visit a qualified specialist workshop immediately.



Display messages	Possible causes/consequences and ► Solutions
	<p>For further information about the Occupant Classification System, see (▷ page 47).</p>
<p>Front Passenger Airbag Enabled See Operator's Manual</p>	<p>The front-passenger air bag is enabled during the journey, even though:</p> <ul style="list-style-type: none"> • a child, a small adult or an object weighing less than the system's weight threshold is located on the front-passenger seat or • the front-passenger seat is unoccupied <p>The system may detect objects or forces applying additional weight on the seat.</p> <p> WARNING</p> <p>The air bag may deploy unintentionally. There is an increased risk of injury.</p> <ul style="list-style-type: none"> ► Pull over and stop the vehicle safely as soon as possible, paying attention to road and traffic conditions. ► Secure the vehicle against rolling away (▷ page 164). ► Switch the ignition off. ► Open the front-passenger door. ► Remove the child and the child restraint system from the front-passenger seat. ► Make sure that there are no objects on the seat adding to the weight. <p>The system may otherwise detect the additional weight and interpret the seat occupant's weight as greater than it actually is.</p> <ul style="list-style-type: none"> ► Keep the seat unoccupied, close the front-passenger door and switch on the ignition. ► Observe the PASSENGER AIR BAG OFF indicator lamp in the center console and the multifunction display and check the following: <p>Seat unoccupied and ignition switched on:</p> <ul style="list-style-type: none"> • the PASSENGER AIR BAG OFF indicator lamp must light up and remain lit. If the indicator lamp is on, OCS (Occupant Classification System) has disabled the front-passenger air bag (▷ page 47). • the Front Passenger Airbag Enabled See Operator's Manual or Front Passenger Airbag Disabled See Operator's Manual display messages must not be shown in the multifunction display.









Display messages	Possible causes/consequences and ► Solutions
	<ul style="list-style-type: none"> ► Wait for a period of at least 60 seconds until the necessary system checks have been completed. ► Make sure that the display messages do not appear in the multifunction display. <p>If these conditions are fulfilled, the front-passenger seat can be occupied again. Whether the PASSENGER AIR BAG OFF indicator lamp remains lit or goes out depends on how OCS classifies the occupant.</p> <p>If the conditions are not fulfilled, the system is not operating correctly.</p> <ul style="list-style-type: none"> ► Visit a qualified specialist workshop immediately. <p>For further information about the Occupant Classification System, see (▷ page 47).</p>

Lights

i Display messages about LEDs:



This display message will only appear if all LEDs have failed.

Display messages	Possible causes/consequences and ► Solutions
 Check Left Cornering Light or Check Right Cornering Light	<p>The left or right-hand cornering light is defective.</p> <ul style="list-style-type: none"> ► Check whether you are permitted to replace the bulb yourself (▷ page 121). <p>or</p> <ul style="list-style-type: none"> ► Visit a qualified specialist workshop.
 Check Left Low Beam or Check Right Low Beam	<p>The left or right-hand low-beam headlamp is defective.</p> <ul style="list-style-type: none"> ► Check whether you are permitted to replace the bulb yourself (▷ page 121). <p>or</p> <ul style="list-style-type: none"> ► Visit a qualified specialist workshop.
 Check Rear Left Turn Signal or Check Rear Right Turn Signal	<p>The rear left-hand or rear right-hand turn signal is defective.</p> <ul style="list-style-type: none"> ► Visit a qualified specialist workshop.

Display messages	Possible causes/consequences and ► Solutions
 <p>Check Front Left Turn Signal or Check Front Right Turn Signal</p>	<p>The front left-hand or front right-hand turn signal is defective.</p> <ul style="list-style-type: none"> ► Visit a qualified specialist workshop.
 <p>Check Left Mirror Turn Signal or Check Right Mirror Turn Signal</p>	<p>The turn signal in the left-hand or right-hand exterior mirror is defective.</p> <ul style="list-style-type: none"> ► Visit a qualified specialist workshop.
 <p>Check Center Brake Lamp</p>	<p>The high-mounted brake lamp is faulty.</p> <ul style="list-style-type: none"> ► Visit a qualified specialist workshop.
 <p>Check Left Tail and Brake Lamps or Check Right Tail and Brake Lamps</p>	<p>The left or right-hand tail lamp/brake lamp is defective.</p> <ul style="list-style-type: none"> ► Check whether you are permitted to replace the bulb yourself (> page 121). or ► Visit a qualified specialist workshop.
 <p>Check Left High Beam or Check Right High Beam</p>	<p>The left or right-hand high beam is defective.</p> <ul style="list-style-type: none"> ► Check whether you are permitted to replace the bulb yourself (> page 121). or ► Visit a qualified specialist workshop.
 <p>Check Left Fog Lamp or Check Right Fog Lamp</p>	<p>The left-hand or right-hand front fog lamp is defective.</p> <ul style="list-style-type: none"> ► Visit a qualified specialist workshop.
 <p>Rear Fog Lamp</p>	<p>The rear fog lamp is defective.</p> <ul style="list-style-type: none"> ► Visit a qualified specialist workshop.
 <p>Check Front Left Parking Lamp or Check Front Right Parking Lamp</p>	<p>The front left or front right parking or standing lamp is defective.</p> <ul style="list-style-type: none"> ► Check whether you are permitted to replace the bulb yourself (> page 121). or ► Visit a qualified specialist workshop.

Display messages	Possible causes/consequences and ► Solutions
 <p>Check Left Reverse Lamp or Check Right Reverse Lamp</p>	<p>The left or right-hand backup lamp is defective.</p> <ul style="list-style-type: none"> ► Check whether you are permitted to replace the bulb yourself (> page 121). or ► Visit a qualified specialist workshop.
 <p>Check Front Left Sidemarker Lamp or Check Front Right Sidemarker Lamp</p>	<p>The left or right front side marker lamp is defective.</p> <ul style="list-style-type: none"> ► Visit a qualified specialist workshop.
 <p>Check Rear Left Sidemarker Lamp or Check Rear Right Sidemarker Lamp</p>	<p>The rear left or right side marker lamp is defective.</p> <ul style="list-style-type: none"> ► Visit a qualified specialist workshop.
 <p>Check Left Daytime Running Light or Check Right Daytime Running Light</p>	<p>The left-hand or right-hand daytime running lamp is faulty.</p> <ul style="list-style-type: none"> ► Visit a qualified specialist workshop.
 <p>Active Headlamps Inoperative</p>	<p>The active light function is defective.</p> <ul style="list-style-type: none"> ► Visit a qualified specialist workshop.
 <p>Malfunction See Operator's Manual</p>	<p>The exterior lighting is defective.</p> <ul style="list-style-type: none"> ► Visit a qualified specialist workshop.
 <p>Malfunction See Operator's Manual</p>	<p>The exterior lighting is defective.</p> <ul style="list-style-type: none"> ► Visit a qualified specialist workshop.
 <p>Auto Lamp Function Inoperative</p>	<p>The light sensor is defective.</p> <ul style="list-style-type: none"> ► Visit a qualified specialist workshop.

Display messages	Possible causes/consequences and ► Solutions
 Switch Off Lights	The lights are still switched on when you leave the vehicle. A warning tone also sounds. ► Turn the light switch to AUTO .
Adaptive Highbeam Assist Inoperative	Adaptive Highbeam Assist is faulty. ► Visit a qualified specialist workshop.
Adaptive Highbeam Assist Currently Unavailable See Operator's Manual	Adaptive Highbeam Assist is deactivated and temporarily inoperative. Possible causes are: <ul style="list-style-type: none"> • the windshield in the camera's field of vision is dirty. • visibility is impaired due to heavy rain, snow or fog. ► Clean the windshield. If the system detects that the camera is fully operational again, the Adaptive Highbeam Assist Now Available again message is displayed. Adaptive Highbeam Assist is operational again.

Engine	
Display messages	Possible causes/consequences and ► Solutions
 Check Coolant Level See Operator's Manual	The coolant level is too low. ! Avoid making long journeys with too little coolant in the engine cooling system. The engine will otherwise be damaged. ► Add coolant, observing the warning notes before doing so (▷ page 290). ► If coolant needs to be added more often than usual, have the engine coolant system checked at a qualified specialist workshop.
	The fan motor is faulty. ► At coolant temperatures below 248 °F (120 °C) drive to the nearest qualified specialist workshop. ► Avoid subjecting the engine to heavy loads, e.g. driving in mountainous terrain, and stop-and-go traffic.

Display messages

Coolant Too Hot
Stop Vehicle Turn
Engine Off

Possible causes/consequences and ► Solutions

The coolant is too hot.
A warning tone also sounds.

 **WARNING**



Do not drive when your engine is overheated. This can cause some fluids which may have leaked into the engine compartment to catch fire.



Steam from the overheated engine can also cause serious burns which can occur just by opening the hood.

There is a risk of injury.



- Pull over and stop the vehicle safely and switch off the engine, paying attention to road and traffic conditions.
- Secure the vehicle against rolling away (▷ page 164).
- Wait until the engine has cooled down.
- Make sure that the air supply to the engine radiator is not blocked, e.g. by snow, slush or ice.
- Do not start the engine again until the display message goes out and the coolant temperature is below 248 °F (120 °C). Otherwise, the engine could be damaged.
- Pay attention to the coolant temperature display.
- If the temperature increases again, visit a qualified specialist workshop immediately.

Under normal operating conditions and with the specified coolant level, the coolant temperature may rise to 248 °F (120 °C).



Display messages	Possible causes/consequences and ► Solutions
	<p>The battery is not being charged. A warning tone also sounds. Possible causes are:</p> <ul style="list-style-type: none"> • a defective alternator • a torn poly-V-belt • a malfunction in the electronics <p>► Pull over and stop the vehicle safely and switch off the engine, paying attention to road and traffic conditions. ► Secure the vehicle against rolling away (► page 164). ► Open the hood. ► Check whether the poly-V-belt is torn.</p> <p>If the poly-V-belt is torn:</p> <p>! Do not continue driving. The engine could otherwise overheat. ► Consult a qualified specialist workshop.</p> <p>If the poly-V-belt is not damaged:</p> <p>► Visit a qualified specialist workshop.</p>
 <p>Check Engine Oil At Next Refueling</p>	<p>The engine oil level has dropped to the minimum level. A warning tone also sounds.</p> <ul style="list-style-type: none"> ► Check the oil level when next refueling, at the latest (► page 289). ► If necessary, add engine oil (► page 289). ► Have the engine checked at a qualified specialist workshop if engine oil needs to be added more often than usual. <p>! Avoid long journeys with too little engine oil. The engine will otherwise be damaged.</p> <p>Information on approved engine oils can be obtained from any qualified specialist workshop or on the Internet at http://bevo.mercedes-benz.com.</p>

Display messages	Possible causes/consequences and ► Solutions
 Check Engine Oil Level (Add 1 quart)	<p>AMG vehicles: the engine oil level is too low.</p> <ul style="list-style-type: none"> ► Check the oil level when next refueling, at the latest (> page 289). ► If necessary, add engine oil (> page 289). ► Have the engine checked at a qualified specialist workshop if engine oil needs to be added more often than usual. <p>! Avoid long journeys with too little engine oil. The engine will otherwise be damaged.</p> <p>Information on approved engine oils can be obtained from any qualified specialist workshop or on the Internet at http://bevo.mercedes-benz.com.</p>
 Fuel Level Low	<p>The fuel level has dropped into the reserve range.</p> <ul style="list-style-type: none"> ► Refuel at the nearest gas station.
 Gas Cap Loose	<p>There is only a very small amount of fuel in the fuel tank.</p> <ul style="list-style-type: none"> ► Refuel at the nearest gas station without fail. <p>The fuel system pressure is too low. The fuel filler cap is not closed correctly or the fuel system is leaking.</p> <ul style="list-style-type: none"> ► Check that the fuel filler cap is correctly closed. <p>If the fuel filler cap is not correctly closed:</p> <ul style="list-style-type: none"> ► Close the fuel filler cap. <p>If the fuel filler cap is correctly closed:</p> <ul style="list-style-type: none"> ► Visit a qualified specialist workshop.

Driving systems

Display messages	Possible causes/consequences and ► Solutions
 Attention Assist: Take a Break!	<p>Based on certain criteria, ATTENTION ASSIST has detected fatigue or a lack of concentration on the part of the driver. A warning tone also sounds.</p> <ul style="list-style-type: none"> ► If necessary, take a break. <p>During long journeys, take regular breaks in good time so you get enough rest.</p>
 Attention Assist Inoperative	<p>ATTENTION ASSIST is inoperative.</p> <ul style="list-style-type: none"> ► Visit a qualified specialist workshop.

Display messages	Possible causes/consequences and ► Solutions
<p>HOLD Off</p>	<p>The HOLD function is deactivated. the vehicle is skidding. A warning tone also sounds.</p> <ul style="list-style-type: none"> ► Reactivate the HOLD function later (▷ page 182). <p>The HOLD function is deactivated. When the brake pedal is firmly depressed, an activation condition is not fulfilled. A warning tone also sounds.</p> <ul style="list-style-type: none"> ► Check the activation conditions for the HOLD function (▷ page 182).
<p>Radar Sensors Deactivated See Operator's Manual</p>	<p>The radar sensor system is deactivated.</p> <ul style="list-style-type: none"> ► Switch on the radar sensor system (▷ page 218).
<p>Lane Keeping Assist Currently Unavailable See Operator's Manual or Active Lane Keeping Assist Currently Unavailable See Operator's Manual</p>	<p>Lane Keeping Assist or Active Lane Keeping Assist is deactivated and temporarily inoperative. Possible causes are:</p> <ul style="list-style-type: none"> • the windshield in the camera's field of vision is dirty. • visibility is impaired due to heavy rain, snow or fog. • there are no lane markings for a longer period. • the lane markings are worn, dark or covered, e.g. by dirt or snow. <p>When the causes stated above no longer apply, the display message disappears.</p> <p>Lane Keeping Assist or Active Lane Keeping Assist is operational again.</p> <p>If the display message does not disappear:</p> <ul style="list-style-type: none"> ► Pull over and stop the vehicle safely as soon as possible, paying attention to road and traffic conditions. ► Secure the vehicle against rolling away (▷ page 164). ► Clean the windshield.
<p>Lane Keeping Assist Inoperative or Active Lane Keeping Assist Inoperative</p>	<p>Lane Keeping Assist or Active Lane Keeping Assist is defective.</p> <ul style="list-style-type: none"> ► Visit a qualified specialist workshop.



Display messages	Possible causes/consequences and ► Solutions
<p>Blind Spot Assist Currently Unavailable See Operator's Manual or Active Blind Spot Assist Currently Unavailable See Operator's Manual</p>	<p>Blind Spot Assist or Active Blind Spot Assist is temporarily inoperative. Possible causes are:</p> <ul style="list-style-type: none"> • the sensors are dirty. • function is impaired due to heavy rain or snow. • the radar sensor system is outside the operating temperature range. • the radar sensor system is temporarily inoperative, e.g. due to electromagnetic radiation emitted by nearby TV or radio stations or other sources of electromagnetic radiation. <p>The yellow  indicator lamps also light up in the exterior mirrors.</p> <p>When the causes stated above no longer apply, the display message disappears.</p> <p>Blind Spot Assist or Active Blind Spot Assist is operational again.</p> <p>If the display message does not disappear:</p> <ul style="list-style-type: none"> ► Pull over and stop the vehicle safely as soon as possible, paying attention to road and traffic conditions. ► Secure the vehicle against rolling away (▷ page 164). ► Clean the sensors (▷ page 295). ► Restart the engine.
<p>Blind Spot Assist Inoperative or Active Blind Spot Assist Inoperative</p>	<p>Blind Spot Assist or Active Blind Spot Assist is defective.</p> <p>The yellow  indicator lamps also light up in the exterior mirrors.</p> <ul style="list-style-type: none"> ► Visit a qualified specialist workshop.
<p>Parking Guidance Inoperative</p>	<p>Parking Guidance is malfunctioning (▷ page 188).</p> <ul style="list-style-type: none"> ► Restart the engine. <p>If the display message continues to be displayed:</p> <ul style="list-style-type: none"> ► Visit a qualified specialist workshop.

Display messages	Possible causes/consequences and ► Solutions
Parking Guidance Canceled	<p>Parking Guidance is deactivated. Possible causes are:</p> <ul style="list-style-type: none"> • the vehicle is skidding. • the sensors are dirty. • a malfunction has occurred. <p>A warning tone also sounds.</p> <p>► Reactivate Parking Guidance later (► page 188).</p> <p>If the parking space symbol does not appear in the multifunction display at speeds below 19 mph (30 km/h):</p> <p>► Clean the sensors (► page 295).</p> <p>► Restart the engine.</p> <p>If the parking space symbol still does not appear in the multifunction display at speeds below 19 mph (30 km/h):</p> <p>► Visit a qualified specialist workshop.</p>
	<p>Parking Guidance has been deactivated because you are no longer following the recommended path.</p> <p>► Park again and, while doing so, observe the display messages in the multifunction display.</p>
Parking Guidance Finished	<p>The vehicle is parked. A warning tone also sounds.</p> <p>The display message disappears automatically.</p>
DISTRONIC PLUS Off	<p>DISTRONIC PLUS has been deactivated (► page 173). If it was deactivated automatically, a warning tone also sounds.</p>
DISTRONIC PLUS Now Available	<p>DISTRONIC PLUS is operational again after having been temporarily unavailable. You can now reactivate DISTRONIC PLUS (► page 173).</p>

Display messages	Possible causes/consequences and ► Solutions
<p>DISTRONIC PLUS Currently Unavailable See Operator's Manual</p>	<p>DISTRONIC PLUS is temporarily inoperative. Possible causes are:</p> <ul style="list-style-type: none"> • function is impaired due to heavy rain or snow. • the sensors in the radiator grill and the bumper are dirty. • the radar sensor system is temporarily inoperative, e.g. due to electromagnetic radiation emitted by nearby TV or radio stations or other sources of electromagnetic radiation. • the system is outside the operating temperature range. • the on-board voltage is too low. <p>A warning tone also sounds.</p> <p>When the causes stated above no longer apply, the display message disappears.</p> <p>DISTRONIC is operational again.</p> <p>If the display message does not disappear:</p> <ul style="list-style-type: none"> ► Pull over and stop the vehicle safely as soon as possible, paying attention to road and traffic conditions. ► Secure the vehicle against rolling away (▷ page 164). ► Clean the sensors in the radiator grill and the bumper (▷ page 295). ► Restart the engine.
<p>DISTRONIC PLUS Inoperative</p>	<p>DISTRONIC PLUS is defective. BAS PLUS and PRE-SAFE® Brake may also have failed.</p> <p>A warning tone also sounds.</p> <ul style="list-style-type: none"> ► Visit a qualified specialist workshop.
<p>DISTRONIC PLUS Passive</p>	<p>You have depressed the accelerator pedal. DISTRONIC PLUS is no longer controlling the speed of the vehicle.</p> <ul style="list-style-type: none"> ► Remove your foot from the accelerator pedal.
<p>DISTRONIC PLUS - - - mph</p>	<p>An activation condition for DISTRONIC PLUS is not fulfilled.</p> <ul style="list-style-type: none"> ► Check the activation conditions for DISTRONIC PLUS (▷ page 173).

Display messages	Possible causes/consequences and ► Solutions
Cruise Control Inoperative	Cruise control is defective. A warning tone also sounds. ► Visit a qualified specialist workshop.
Cruise Control - - - mph	A condition for activating cruise control has not been fulfilled. You have tried to store a speed below 20 mph (30 km/h), for example. ► If conditions permit, drive faster than 20 mph (30 km/h) and store the speed. ► Check the activation conditions for cruise control (> page 171).





Tires	
Display messages	Possible causes/consequences and ► Solutions
Check Tire Pressure Soon	<p>Canada only: The tire pressure loss warning system has detected a significant loss in pressure. A warning tone also sounds.</p> <p> WARNING</p> <p>With tire pressures which are too low, there is a risk of the following hazards:</p> <ul style="list-style-type: none"> • they may burst, especially as the load and vehicle speed increase. • they may wear excessively and/or unevenly, which may greatly impair tire traction. • the driving characteristics, as well as steering and braking, may be greatly impaired. <p>There is a risk of an accident.</p> <ul style="list-style-type: none"> ► Stop the vehicle without making any sudden steering or braking maneuvers. Pay attention to the traffic conditions as you do so. ► Secure the vehicle against rolling away (▷ page 164). ► Check the tires and, if necessary, follow the instructions for a flat tire (▷ page 301). ► Check the tire pressures and, if necessary, correct the tire pressure. ► Restart the tire pressure loss warning system when the tire pressure is correct (▷ page 321).
Check Tire Pressure Then Restart Run Flat Indicator	<p>Canada only: The tire pressure loss warning system generated a display message and has not been restarted since.</p> <ul style="list-style-type: none"> ► Set the correct tire pressure in all four tires. ► Restart the tire pressure loss warning system (▷ page 321).
Run Flat Indicator Inoperative	<p>Canada only: The tire pressure loss warning system is faulty.</p> <ul style="list-style-type: none"> ► Visit a qualified specialist workshop.
Correct Tire Pressure	<p>The tire pressure is too low in at least one of the tires, or the tire pressure difference between the wheels is too great.</p> <ul style="list-style-type: none"> ► Check the tire pressures at the next opportunity (▷ page 322). ► If necessary, correct the tire pressure. ► Restart the tire pressure monitor (▷ page 325).



Display messages	Possible causes/consequences and ► Solutions
<p>Check Tires</p>	<p>The tire pressure in one or more tires has dropped significantly. The wheel position is displayed in the multifunction display. A warning tone also sounds.</p> <p> WARNING</p> <p>With tire pressures which are too low, there is a risk of the following hazards:</p> <ul style="list-style-type: none"> • they may burst, especially as the load and vehicle speed increase. • they may wear excessively and/or unevenly, which may greatly impair tire traction. • the driving characteristics, as well as steering and braking, may be greatly impaired. <p>There is a risk of an accident.</p> <ul style="list-style-type: none"> ► Stop the vehicle without making any sudden steering or braking maneuvers. Pay attention to the traffic conditions as you do so. ► Secure the vehicle against rolling away (► page 164). ► Check the tires and, if necessary, follow the instructions for a flat tire (► page 301). ► Check the tire pressure (► page 322). ► If necessary, correct the tire pressure.
<p>Warning Tire Malfunction</p>	<p>The tire pressure in one or more tires has dropped suddenly. The wheel position is shown in the multifunction display.</p> <p> WARNING</p> <p>If you drive with a flat tire, there is a risk of the following hazards:</p> <ul style="list-style-type: none"> • a flat tire affects the ability to steer or brake the vehicle. • you could lose control of the vehicle. • continued driving with a flat tire will cause excessive heat build-up and possibly a fire. <p>There is a risk of an accident.</p> <ul style="list-style-type: none"> ► Stop the vehicle without making any sudden steering or braking maneuvers. Pay attention to the traffic conditions as you do so. ► Secure the vehicle against rolling away (► page 164). ► Check the tires and, if necessary, follow the instructions for a flat tire (► page 301).

Display messages	Possible causes/consequences and ► Solutions
Tire Press. Monitor Currently Unavailable	Due to a source of radio interference, no signals can be received from the wheel sensors. The tire pressure monitor is temporarily malfunctioning. ► Drive on. The tire pressure monitor restarts automatically as soon as the problem has been solved.
TirePress. Sensor(s) Missing	There is no signal from the tire pressure sensor of one or several wheels. The pressure of the affected tire is not displayed in the multifunction display. ► Have the faulty tire pressure sensor replaced at a qualified specialist workshop.
Tire Pressure Monitor Inoperative No Wheel Sensors	The wheels mounted do not have a suitable tire pressure sensor. The tire pressure monitor is deactivated. ► Mount wheels with suitable tire pressure sensors. The tire pressure monitor is activated automatically after driving for a few minutes.
Tire pressure monitor Inoperative	The tire pressure monitor is faulty. ► Visit a qualified specialist workshop.





Vehicle





Display messages	Possible causes/consequences and ► Solutions
Shift to 'P' or 'N' to Start Engine	You have attempted to start the engine with the transmission in position R or D . ► Shift the transmission to position P or N .
Risk of Rolling Shift to 'P'	You have attempted to stop the engine with the Start/Stop button while the transmission was not in position P . ► Shift the transmission to position P .



Display messages	Possible causes/consequences and ► Solutions
	<p>While the HOLD function or DISTRONIC PLUS is active, you have:</p> <ul style="list-style-type: none"> • opened the driver's door and released the seat belt or • switched off the engine or • opened the hood <p>A tone may also sound at regular intervals. If you attempt to lock the vehicle, the tone becomes louder.</p> <p>You cannot start the engine.</p> <p>► Shift the transmission to position P. You can restart the engine.</p>
	<p>The trunk lid is open.</p> <p>► Close the trunk lid.</p>
	<p>The hood is open.</p> <p>⚠ WARNING</p> <p>The open hood may block your view when the vehicle is in motion. There is a risk of an accident.</p> <p>► Pull over and stop the vehicle safely as soon as possible, paying attention to road and traffic conditions.</p> <p>► Secure the vehicle against rolling away (> page 164).</p> <p>► Close the hood.</p>
	<p>At least one door is open.</p> <p>► Close all the doors.</p>
 <p>Rear Left Backrest Not Latched or Rear Right Backrest Not Latched</p>	<p>The backrest in the rear is not engaged on the left-hand and/or right-hand side.</p> <p>► Push the backrest back until it engages.</p>

Display messages	Possible causes/consequences and ► Solutions
 <p>Power Steering Malfunction See Operator's Manual</p>	<p>The power steering is malfunctioning. A warning tone also sounds.</p> <p> WARNING</p> <p>You will need to use more force to steer. There is a risk of an accident.</p> <ul style="list-style-type: none"> ► Check whether you are able to apply the extra force required. ► If you are able to steer safely: carefully drive on to a qualified specialist workshop. ► If you are unable to steer safely: do not drive on. Contact the nearest qualified specialist workshop.
<p>Phone No Service</p>	<p>Your vehicle is outside the network provider's transmitter/receiver range.</p> <ul style="list-style-type: none"> ► Wait until the mobile phone operational readiness symbol appears in the multifunction display.
 <p>Check Washer Fluid</p>	<p>The washer fluid level in the washer fluid reservoir has dropped below the minimum.</p> <ul style="list-style-type: none"> ► Add washer fluid (► page 291).

SmartKey



Display messages	Possible causes/consequences and ► Solutions
 <p>Key Does Not Belong to Vehicle</p>	<p>You have put the wrong SmartKey in the ignition lock.</p> <ul style="list-style-type: none"> ► Use the correct SmartKey.
 <p>Take Your Key from Ignition</p>	<p>The SmartKey is in the ignition lock.</p> <ul style="list-style-type: none"> ► Remove the SmartKey.
 <p>Obtain a New Key</p>	<p>The SmartKey needs to be replaced.</p> <ul style="list-style-type: none"> ► Visit a qualified specialist workshop.
 <p>Replace Key Battery</p>	<p>The batteries of the KEYLESS-GO key are discharged.</p> <ul style="list-style-type: none"> ► Change the batteries (► page 79).

Display messages	Possible causes/consequences and ► Solutions
 <p data-bbox="211 324 431 383">Don't Forget Your Key</p>	<p data-bbox="468 274 1134 329">The display message is shown for a maximum of 60 seconds and is only a reminder.</p> <p data-bbox="468 336 1122 396">You have opened the driver's door with the engine switched off. The KEYLESS-GO key is not in the ignition lock.</p> <ul style="list-style-type: none"> <li data-bbox="468 403 1100 458">► Remember to take the KEYLESS-GO key with you when you leave the vehicle.
 <p data-bbox="211 534 436 593">Key Not Detected (red display message)</p>	<p data-bbox="468 483 898 512">The KEYLESS-GO key is not in the vehicle.</p> <p data-bbox="468 519 758 548">A warning tone also sounds.</p> <p data-bbox="468 555 1113 611">If the engine is switched off, you can no longer lock the vehicle centrally or start the engine.</p> <ul style="list-style-type: none"> <li data-bbox="468 618 1134 677">► Pull over and stop the vehicle safely as soon as possible, paying attention to road and traffic conditions. <li data-bbox="468 684 1027 743">► Secure the vehicle against rolling away (▷ page 164) (▷ page 164). <li data-bbox="468 750 788 779">► Locate the KEYLESS-GO key. <p data-bbox="468 808 1134 863">The KEYLESS-GO key is not detected while the engine is running because there is interference from a strong source of radio waves.</p> <p data-bbox="468 870 758 899">A warning tone also sounds.</p> <ul style="list-style-type: none"> <li data-bbox="468 906 1134 965">► Pull over and stop the vehicle safely as soon as possible, paying attention to road and traffic conditions. <li data-bbox="468 973 1034 1001">► Secure the vehicle against rolling away (▷ page 164). <li data-bbox="468 1008 1087 1037">► Operate the vehicle with the SmartKey in the ignition lock.
 <p data-bbox="211 1111 419 1198">Key Not Detected (white display message)</p>	<p data-bbox="468 1060 1008 1089">The KEYLESS-GO key cannot be detected at present.</p> <ul style="list-style-type: none"> <li data-bbox="468 1096 1096 1155">► Change the location of the SmartKey with the KEYLESS-GO functions in the vehicle. <p data-bbox="468 1166 911 1195">If the KEYLESS-GO key is still not detected:</p> <ul style="list-style-type: none"> <li data-bbox="468 1202 1087 1231">► Operate the vehicle with the SmartKey in the ignition lock.
 <p data-bbox="211 1313 406 1372">Key Detected in Vehicle</p>	<p data-bbox="468 1263 1134 1318">The KEYLESS-GO key has been detected inside the vehicle during locking.</p> <ul style="list-style-type: none"> <li data-bbox="468 1326 972 1354">► Remove the KEYLESS-GO key from the vehicle.

Display messages	Possible causes/consequences and ► Solutions
 <p>Remove 'Start' Button and Insert Key</p>	<p>The KEYLESS-GO key can continuously not be detected. KEYLESS-GO is temporarily malfunctioning or is defective. A warning tone also sounds.</p> <ul style="list-style-type: none"> ► Insert the SmartKey into the ignition lock and turn it to the desired position. ► Visit a qualified specialist workshop.
 <p>Close Doors to Lock Vehicle</p>	<p>At least one door is open. A warning tone also sounds.</p> <ul style="list-style-type: none"> ► Close all doors and lock the vehicle again.





Warning and indicator lamps in the instrument cluster



Seat belts









Problem	Possible causes/consequences and ► Solutions
 <p>After starting the engine, the red seat belt warning lamp lights up for 6 seconds.</p>	<p>The seat belt warning lamp reminds the driver and front passenger to fasten their seat belts.</p> <ul style="list-style-type: none"> ► Fasten your seat belt (▷ page 56).
 <p>After starting the engine, the red seat belt warning lamp lights up. In addition, a warning tone sounds for up to six seconds.</p>	<p>The driver's seat belt is not fastened.</p> <ul style="list-style-type: none"> ► Fasten your seat belt (▷ page 56). The warning tone ceases.
 <p>The red seat belt warning lamp lights up after the engine starts, as soon as the driver's or the front-passenger door is closed.</p>	<p>The driver or front passenger has not fastened their seat belt.</p> <ul style="list-style-type: none"> ► Fasten your seat belt (▷ page 56). The warning lamp goes out. <p>There are objects on the front-passenger seat.</p> <ul style="list-style-type: none"> ► Remove the objects from the front-passenger seat and stow them in a secure place. The warning lamp goes out.







Problem	Possible causes/consequences and ► Solutions
 <p>The red seat belt warning lamp flashes and an intermittent audible warning sounds.</p>	<p>The driver or front passenger has not fastened their seat belt. The car is being driven faster than 15 mph (25 km/h) or has briefly been driven faster than 15 mph (25 km/h).</p> <ul style="list-style-type: none">► Fasten your seat belt (▷ page 56). The warning lamp goes out and the intermittent warning tone ceases. <p>There are objects on the front-passenger seat. The car is being driven faster than 15 mph (25 km/h) or has briefly been driven faster than 15 mph (25 km/h).</p> <ul style="list-style-type: none">► Remove the objects from the front-passenger seat and stow them in a secure place. The warning lamp goes out and the intermittent warning tone ceases.





Safety systems





Problem	Possible causes/consequences and ► Solutions
<p> (USA only)  (Canada only)</p> <p>The red brake system warning lamp comes on while the engine is running. A warning tone also sounds.</p>	<p>There is not enough brake fluid in the brake fluid reservoir.</p> <p> WARNING</p> <p>The braking effect may be impaired. There is a risk of an accident.</p> <ul style="list-style-type: none"> ► Pull over and stop the vehicle safely as soon as possible, paying attention to road and traffic conditions. Do not continue driving under any circumstances. ► Secure the vehicle against rolling away (▷ page 164). ► Do not add brake fluid. Topping up will not remedy the malfunction. ► Consult a qualified specialist workshop. ► Observe the additional display messages in the multifunction display.
<p></p> <p>The yellow ABS warning lamp is lit while the engine is running.</p>	<p>ABS (Anti-lock Brake System) is deactivated due to a malfunction. BAS (Brake Assist), BAS PLUS, ESP® (Electronic Stability Program), PRE-SAFE®, PRE-SAFE® Brake, the HOLD function and hill start assist are therefore also deactivated, for example. ATTENTION ASSIST is deactivated.</p> <p> WARNING</p> <p>The brake system continues to function normally, but without the functions listed above. The wheels could therefore lock if you brake hard, for example.</p> <p>The steerability and braking characteristics may be severely affected. The braking distance in an emergency braking situation can increase.</p> <p>If ESP® is not operational, ESP® is unable to stabilize the vehicle. There is an increased risk of skidding and an accident.</p> <ul style="list-style-type: none"> ► Observe the additional display messages in the multifunction display. ► Drive on carefully. ► Visit a qualified specialist workshop. <p>If the ABS control unit is faulty, there is also a possibility that other systems, such as the navigation system or the automatic transmission, will not be available.</p>





Problem	Possible causes/consequences and ► Solutions
 <p>The yellow ABS warning lamp is lit while the engine is running.</p>	<p>ABS is temporarily unavailable. BAS, BAS PLUS, ESP[®], EBD (electronic brake force distribution), PRE-SAFE[®], PRE-SAFE[®] Brake, the HOLD function, hill start assist are therefore also deactivated, for example.</p> <p>Possible causes are:</p> <ul style="list-style-type: none"> • Self-diagnosis is not yet complete. • The on-board voltage may be insufficient. <p>ATTENTION ASSIST is deactivated.</p> <p> WARNING</p> <p>The brake system continues to function normally, but without the functions listed above. The front and rear wheels could therefore lock if you brake hard, for example.</p> <p>The steerability and braking characteristics may be severely affected. The braking distance in an emergency braking situation can increase.</p> <p>If ESP[®] is not operational, ESP[®] is unable to stabilize the vehicle. There is a risk of an accident.</p> <p>► Carefully drive a suitable distance, making slight steering movements at a speed above 12 mph (20 km/h). The functions mentioned above are available again when the warning lamp goes out.</p> <p>If the warning lamp is still on:</p> <ul style="list-style-type: none"> ► Observe the additional display messages in the multifunction display. ► Drive on carefully. ► Visit a qualified specialist workshop.

Problem	Possible causes/consequences and ► Solutions
 <p>The yellow ABS warning lamp is lit while the engine is running. A warning tone also sounds.</p>	<p>EBD is not available due to a malfunction. Therefore, ABS, BAS, BAS PLUS, ESP[®], PRE-SAFE[®], PRE-SAFE[®] Brake, the HOLD function and hill start assist are also unavailable, for example. ATTENTION ASSIST is deactivated.</p> <p> WARNING</p> <p>The brake system continues to function normally, but without the functions listed above. The front and rear wheels could therefore lock if you brake hard, for example.</p> <p>The steerability and braking characteristics may be severely affected. The braking distance in an emergency braking situation can increase.</p> <p>If ESP[®] is not operational, ESP[®] is unable to stabilize the vehicle. There is an increased risk of skidding and an accident.</p> <ul style="list-style-type: none"> ► Observe the additional display messages in the multifunction display. ► Drive on carefully. ► Visit a qualified specialist workshop.
<p> (USA only)</p> <p> (Canada only)</p> <p>  </p> <p>The red brake warning lamp, the yellow ESP[®] and ESP[®] OFF warning lamps and the yellow ABS warning lamp are lit while the engine is running.</p>	<p>ABS and ESP[®] are not available due to a malfunction. Therefore, BAS, BAS PLUS, EBD, PRE-SAFE[®], PRE-SAFE[®] Brake, the HOLD function and hill start assist, for example, are not available either. ATTENTION ASSIST is deactivated.</p> <p> WARNING</p> <p>The brake system continues to function normally, but without the functions listed above. The front and rear wheels could therefore lock if you brake hard, for example.</p> <p>The steerability and braking characteristics may be severely affected. The braking distance in an emergency braking situation can increase.</p> <p>If ESP[®] is not operational, ESP[®] is unable to stabilize the vehicle. There is an increased risk of skidding and an accident.</p> <ul style="list-style-type: none"> ► Observe the additional display messages in the multifunction display. ► Drive on carefully. ► Visit a qualified specialist workshop.



Problem	Possible causes/consequences and ► Solutions
  The yellow ESP® warning lamp flashes while the vehicle is in motion.	ESP® or traction control has intervened because there is a risk of skidding or at least one wheel has started to spin. Cruise control or DISTRONIC PLUS is deactivated. <ul style="list-style-type: none"> ▶ When pulling away, only depress the accelerator pedal as far as necessary. ▶ Ease off the accelerator pedal while the vehicle is in motion. ▶ Adapt your driving style to suit the road and weather conditions. ▶ Do not deactivate ESP®. For exceptions, see: (▷ page 68).
 The yellow ESP® OFF warning lamp is lit while the engine is running.	ESP® is deactivated. <p> WARNING</p> If ESP® is switched off, ESP® is unable to stabilize the vehicle. There is an increased risk of skidding and an accident. <ul style="list-style-type: none"> ▶ Reactivate ESP®. For exceptions, see: (▷ page 68). <ul style="list-style-type: none"> ▶ Adapt your driving style to suit the road and weather conditions. If ESP® cannot be activated: <ul style="list-style-type: none"> ▶ Drive on carefully. ▶ Have ESP® checked at a qualified specialist workshop.
 AMG vehicles only: The yellow SPORT handling mode warning lamp is lit while the engine is running.	SPORT handling mode is activated. <p> WARNING</p> When SPORT handling mode is switched on, ESP® is unable to stabilize the vehicle. There is an increased risk of skidding and an accident. <ul style="list-style-type: none"> ▶ Only switch to SPORT handling mode in accordance with the conditions written in the "Activating/deactivating SPORT handling mode" section (▷ page 69).

Problem	Possible causes/consequences and ► Solutions
   <p>The yellow ESP[®] and ESP[®] OFF warning lamps are lit while the engine is running.</p>	<p>ESP[®], BAS, BAS PLUS, PRE-SAFE[®], PRE-SAFE[®] Brake, the HOLD function and hill start assist are not available due to a malfunction. ATTENTION ASSIST is deactivated.</p> <p> WARNING</p> <p>The brake system continues to function normally, but without the functions listed above.</p> <p>The braking distance in an emergency braking situation can thus increase.</p> <p>If ESP[®] is not operational, ESP[®] is unable to stabilize the vehicle. There is an increased risk of skidding and an accident.</p> <ul style="list-style-type: none"> ► Observe the additional display messages in the multifunction display. ► Drive on carefully. ► Visit a qualified specialist workshop.

Problem	Possible causes/consequences and ► Solutions
 <p>The yellow ESP[®] and ESP[®] OFF warning lamps are lit while the engine is running.</p>	<p>ESP[®], BAS, PRE-SAFE[®], the HOLD function and hill start assist are temporarily unavailable. BAS PLUS and PRE-SAFE[®] Brake may also have failed. ATTENTION ASSIST is deactivated. Self-diagnosis is not yet complete.</p> <p> WARNING</p> <p>The brake system continues to function normally, but without the functions listed above. The braking distance in an emergency braking situation can thus increase. If ESP[®] is not operational, ESP[®] is unable to stabilize the vehicle. There is an increased risk of skidding and an accident.</p> <p>► Carefully drive a suitable distance, making slight steering movements at a speed above 12 mph (20 km/h). The functions mentioned above are available again when the warning lamp goes out.</p> <p>If the warning lamp is still on:</p> <ul style="list-style-type: none"> ► Observe the additional display messages in the multifunction display. ► Drive on carefully. ► Visit a qualified specialist workshop.
 <p>The red SRS warning lamp is lit while the engine is running.</p>	<p>There is a malfunction in the SRS (Supplemental Restraint System).</p> <p> WARNING</p> <p>The air bags or Emergency Tensioning Devices may either be triggered unintentionally or, in the event of an accident, may not be triggered. There is an increased risk of injury.</p> <ul style="list-style-type: none"> ► Drive on carefully. ► Have SRS checked at a qualified specialist workshop immediately. <p>For further information about the Supplemental Restraint System, see (► page 41).</p>





Engine	
Problem	Possible causes/consequences and ► Solutions
 <p>The yellow Check Engine warning lamp lights up while the engine is running.</p>	<p>There may be a malfunction, for example:</p> <ul style="list-style-type: none"> • in the engine management • in the fuel injection system • in the exhaust system • in the ignition system • in the fuel system <p>The emission limit values may be exceeded and the engine may be in emergency mode.</p> <p>► Have the vehicle checked as soon as possible at a qualified specialist workshop.</p> <p>i In some states, you must immediately visit a qualified specialist workshop as soon as the yellow Check Engine warning lamp lights up. This is due to the legal requirements in effect in these states. If in doubt, check whether such legal regulations apply in the state in which you are currently driving.</p>
 <p>The yellow reserve fuel warning lamp flashes while the vehicle is in motion. In addition, the  Check Engine warning lamp may light up.</p>	<p>The fuel system pressure is too low. The fuel filler cap is not closed correctly or the fuel system is leaking.</p> <p>► Observe the additional display messages in the multifunction display.</p> <p>► Check that the fuel filler cap is correctly closed.</p> <p>► If the fuel filler cap is not correctly closed: close the fuel filler cap.</p> <p>► If the fuel filler cap is closed: visit a qualified specialist workshop.</p>
 <p>The yellow reserve fuel warning lamp lights up while the engine is running.</p>	<p>The fuel level has dropped into the reserve range.</p> <p>► Refuel at the nearest gas station.</p>





Problem	Possible causes/consequences and ► Solutions
 <p>The red coolant warning lamp lights up while the engine is running and the coolant temperature gauge is at the start of the scale.</p>	<p>The temperature sensor for the coolant temperature gauge is defective.</p> <p>The coolant temperature is no longer being monitored. There is a risk of engine damage if the coolant temperature is too high.</p> <ul style="list-style-type: none">► Pull over and stop the vehicle safely and switch off the engine, paying attention to road and traffic conditions. Do not continue driving under any circumstances.► Secure the vehicle against rolling away (▷ page 164).► Consult a qualified specialist workshop.

Problem	Possible causes/consequences and ► Solutions
 <p>The red coolant warning lamp comes on while the engine is running.</p>	<p>The coolant level is too low.</p> <p>If the coolant level is correct, the airflow to the engine radiator may be blocked or the electric engine radiator fan may be malfunctioning.</p> <p>The coolant is too hot and the engine is no longer being cooled sufficiently.</p> <ul style="list-style-type: none"> ► Observe the additional display messages in the multifunction display. ► Pull over and stop the vehicle safely and switch off the engine, paying attention to road and traffic conditions. ► Secure the vehicle against rolling away (▷ page 164). ► Wait until the engine has cooled down. ► Make sure that the air supply to the engine radiator is not blocked, e.g. by snow, slush or ice. ► Check the coolant level and add coolant (▷ page 290). Observe the warning notes. ► If you need to add coolant more often than usual, have the engine coolant system checked. ► At coolant temperatures below 248 °F (120 °C) drive to the nearest qualified specialist workshop. ► Avoid subjecting the engine to heavy loads, e.g. driving in mountainous terrain, and stop-and-go traffic.
 <p>The red coolant warning lamp comes on while the engine is running. A warning tone also sounds.</p>	<p>The coolant temperature has exceeded 248 °F (120 °C). The airflow to the engine radiator may be blocked or the coolant level may be too low.</p> <p> WARNING</p> <p>The engine is not being cooled sufficiently and may be damaged. Do not drive when your engine is overheated. This can cause some fluids which may have leaked into the engine compartment to catch fire.</p> <p>Steam from the overheated engine can also cause serious burns which can occur just by opening the hood.</p> <p>There is a risk of injury.</p> <ul style="list-style-type: none"> ► Observe the additional display messages in the multifunction display. ► Pull over and stop the vehicle safely and switch off the engine, paying attention to road and traffic conditions. ► Secure the vehicle against rolling away (▷ page 164). ► Wait until the engine has cooled down.

Problem	Possible causes/consequences and ► Solutions
	<ul style="list-style-type: none"> ▶ Make sure that the air supply to the engine radiator is not blocked, e.g. by snow, slush or ice. ▶ Check the coolant level and add coolant (▷ page 290). Observe the warning notes. ▶ If you need to add coolant more often than usual, have the engine coolant system checked. ▶ At coolant temperatures below 248 °F (120 °C) drive to the nearest qualified specialist workshop. ▶ Avoid subjecting the engine to heavy loads, e.g. driving in mountainous terrain, and stop-and-go traffic.

Driving systems

Problem	Possible causes/consequences and ► Solutions
 <p>The red distance warning lamp lights up while the vehicle is in motion.</p>	<p> WARNING</p> <p>The distance to the vehicle in front is too small for the speed selected.</p> <p>There is a risk of an accident.</p> <ul style="list-style-type: none"> ▶ Increase the distance.
 <p>The red distance warning lamp lights up while the vehicle is in motion. A warning tone also sounds.</p>	<p> WARNING</p> <p>You are approaching a vehicle or a stationary obstacle in your line of travel at too high a speed.</p> <p>There is a risk of an accident.</p> <ul style="list-style-type: none"> ▶ Be prepared to brake immediately. ▶ Pay careful attention to the traffic situation. You may have to brake or take evasive action. <p>More information about DISTRONIC PLUS (▷ page 173) and PRE-SAFE® Brake (▷ page 71).</p>

Tires	
Problem	Possible causes/consequences and ► Solutions
 The yellow tire pressure monitor warning lamp (pressure loss/malfunction) is lit.	<p>The tire pressure monitor has detected a loss of pressure in at least one of the tires.</p> <p> WARNING</p> <p>With tire pressures which are too low, there is a risk of the following hazards:</p> <ul style="list-style-type: none"> • they may burst, especially as the load and vehicle speed increase. • they may wear excessively and/or unevenly, which may greatly impair tire traction. • the driving characteristics, as well as steering and braking, may be greatly impaired. <p>There is a risk of an accident.</p> <ul style="list-style-type: none"> ► Stop the vehicle without making any sudden steering or braking maneuvers. Pay attention to the traffic conditions as you do so. ► Secure the vehicle against rolling away (▷ page 164). ► Observe the additional display messages in the multifunction display. ► Check the tires and, if necessary, follow the instructions for a flat tire (▷ page 301). ► Check the tire pressure (▷ page 322). ► If necessary, correct the tire pressure.
 The yellow tire pressure monitor warning lamp (pressure loss/malfunction) flashes for approximately one minute and then remains lit.	<p>The tire pressure monitor is faulty.</p> <p> WARNING</p> <p>The system is possibly unable to recognize or register low tire pressure.</p> <p>There is a risk of an accident.</p> <ul style="list-style-type: none"> ► Observe the additional display messages in the multifunction display. ► Visit a qualified specialist workshop.

Useful information	262
Loading guidelines	262
Stowage areas	262
Features	267

Useful information

- i** This Operator's Manual describes all models and all standard and optional equipment of your vehicle available at the time of publication of the Operator's Manual. Country-specific differences are possible. Please note that your vehicle may not be equipped with all features described. This also applies to safety-related systems and functions.
- i** Read the information on qualified specialist workshops: (▷ page 25).

Loading guidelines

WARNING

If objects, luggage or loads are not secured or not secured sufficiently, they could slip, tip over or be flung around and thereby hit vehicle occupants. There is a risk of injury, particularly in the event of sudden braking or a sudden change in direction.

Always store objects so that they cannot be flung around. Secure objects, luggage or loads against slipping or tipping before the journey.

WARNING

Combustion engines emit poisonous exhaust gases such as carbon monoxide. Exhaust gases can enter the vehicle interior if the trunk lid is open when the engine is running, especially if the vehicle is in motion. There is a risk of poisoning.

Always switch off the engine before opening the trunk lid. Never drive with the trunk lid open.

The handling characteristics of a laden vehicle are dependent on the distribution of the load within the vehicle. For this reason, you should observe the following notes when transporting a load:

- Never exceed the maximum permissible gross vehicle weight or the gross axle weight rating of the vehicle (including occupants). The values are specified on the vehicle identification plate on the B-pillar of the driver's door.
- The trunk is the preferred place to carry objects.
- Position heavy loads as far forwards as possible and as low down in the trunk as possible.
- The load must not protrude above the upper edge of the seat backrests.
- Always place the load against the rear or front seat backrests. Make sure that the seat backrests are securely locked into place.
- Always place the load behind unoccupied seats if possible.
- Use the cargo tie down rings and the parcel nets to transport loads and luggage.
- Use cargo tie-down rings and fastening materials appropriate for the weight and size of the load.
- Secure the load with sufficiently strong and wear-resistant tie-downs. pad sharp edges for protection.

Stowage areas

Stowage space

Important safety notes

WARNING

If you do not correctly store objects in the vehicle interior, they can slip or be flung around, thus striking vehicle occupants. There is a risk of injury, especially when braking or abruptly changing directions.

- Always store objects so that they cannot be flung around in these or in similar situations.
- Always make sure that objects do not protrude from stowage compartments, parcel nets or stowage nets.
- Close lockable stowage compartments while driving.
- Stow and secure objects that are heavy, hard, pointy, sharp-edged, fragile or too large in the trunk.

Observe the loading guidelines (▷ page 262).

Stowage compartments in the front

Glove box

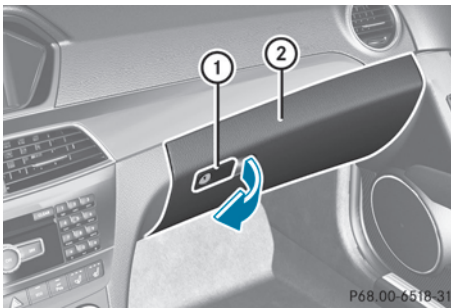

- ▶ **To open:** pull handle ① and open glove box flap ②.
- ▶ **To close:** fold glove box flap ② upwards until it engages.

The glove box can only be locked and unlocked using the mechanical key.

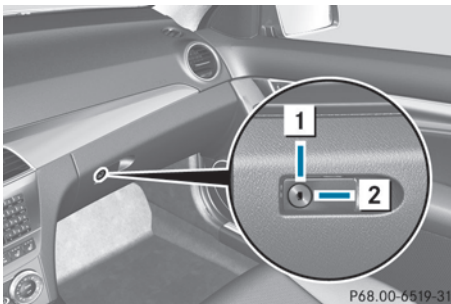

- ▶ **To lock:** insert the mechanical key into the lock and turn it 90° clockwise to position ②.
- ▶ **To unlock:** insert the mechanical key into the lock and turn it 90° counter-clockwise to position ①.

i The glove box can be cooled (▷ page 143).

Eyeglasses compartment

There is a compartment to stow eyeglasses in the headliner on the driver's side.

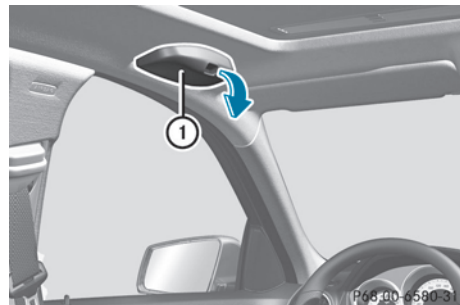

- ▶ **To open:** pull down eyeglasses compartment ① by the handle.

Stowage compartment under the armrest

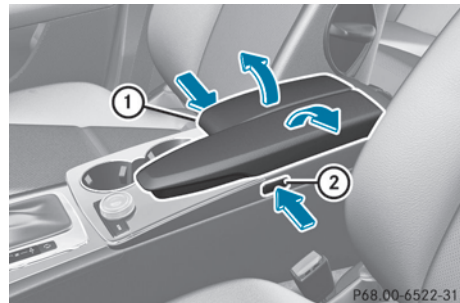

- ▶ **To open:** press left-hand button ② or right-hand button ①. The stowage compartment opens.

i Depending on the vehicle's equipment, a USB connection and an AUX IN connection or a Media Interface are installed in the stowage compartment. A Media Interface

is a universal interface for portable audio equipment, e.g. for an iPod® or MP3 player (see the separate Audio or COMAND Operating Instructions).

Storage compartment under the front seats

WARNING

If you exceed the maximum load for the stowage compartment, the cover may not be able to restrain the items. Items may be thrown out of the stowage compartment and hit vehicle occupants. There is a risk of injury, particularly in the event of sudden braking or a sudden change in direction.

Never exceed the maximum permissible load for the stowage compartment. Stow and secure heavy objects in the trunk.

The maximum permissible load of the stowage compartment is 3.3 lbs (1.5 kg).

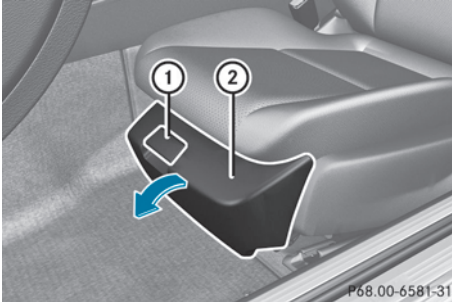

- ▶ **To open:** pull handle ① up and fold cover ② forwards.

Storage space in the rear

Storage compartment in the rear

! Do not sit on or support your body weight on the rear seat armrest when it is folded down, as you could otherwise damage it.

! Close the cover of the stowage compartment before folding the rear seat armrest back into the seat backrest.

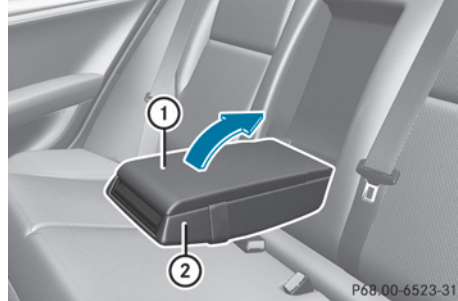

- ▶ **To open:** fold down seat armrest ②.
- ▶ Fold cover ① of the armrest upwards.

Storage net

Storage nets are located in the front-passenger footwell and on the left-hand side of the trunk.

Observe the loading guidelines (▶ page 262) and the safety notes regarding stowage spaces (▶ page 262).

Rear bench seat through-loading feature

Important safety notes

WARNING

If the rear bench seat/rear seat and seat backrest are not engaged they could fold forwards, e.g. when braking suddenly or in the event of an accident.

- The vehicle occupant would thereby be pushed into the seat belt by the rear bench seat/rear seat or by the seat backrest. The seat belt can no longer offer the intended level of protection and could even cause injuries.
- Objects or loads in the trunk cannot be restrained by the seat backrest.

There is an increased risk of injury.

Before every trip, make sure that the seat backrests and the rear bench seat/rear seat are engaged.

Observe the loading guidelines (▷ page 262). The left-hand and right-hand rear seat backrests can be folded down separately to increase the trunk capacity.

Folding the seat backrest forward

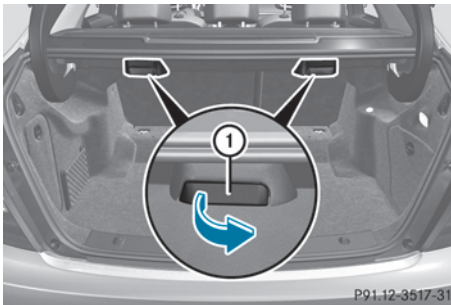

- ▶ Move the driver's or front-passenger seat forward if necessary.
- ▶ Open the trunk.
- ▶ Pull right-hand or left-hand rear seat backrest release handle ①. The corresponding rear seat backrest is released.
- ▶ Fully insert the rear seat backrest head restraints.

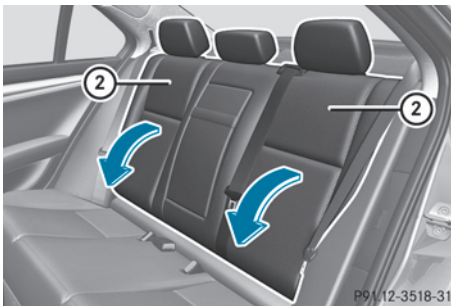

- ▶ Fold rear seat backrest ② forwards.
- ▶ Move the driver's or front-passenger seat back if necessary.

Folding the seat backrest back

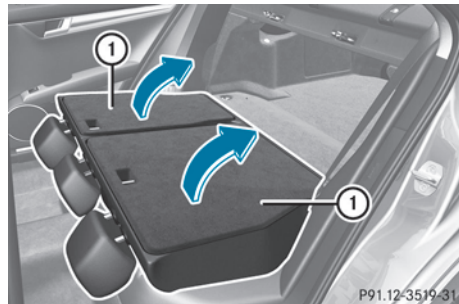

- ▶ Move the driver's or front-passenger seat forward if necessary.
- ⚠ Make sure that the seat belt does not become trapped when folding the rear seat backrest back. Otherwise, it could be damaged.
- ▶ Fold rear seat backrest ① back until it engages. If the rear seat backrest is not engaged and locked, this will be shown in the multifunction display in the instrument cluster. A warning tone also sounds.

i You should always engage the rear seat backrests if you do not need the through-loading feature. This will prevent unauthorized access to the trunk from the vehicle interior.

- ▶ Adjust the head restraints if necessary (▷ page 102).
- ▶ Move the driver's or front-passenger seat back if necessary.

Securing cargo

Cargo tie-down rings

Observe the following notes on securing loads:

- Observe the loading guidelines (▷ page 262).
- Secure the load using the cargo tie-down rings.

- Distribute the load on the cargo tie down rings evenly.
- Do not use elastic straps or nets to secure a load, as these are only intended as an anti-slip protection for light loads.
- Do not route tie-downs across sharp edges or corners.
- Pad sharp edges for protection.

There are four cargo tie down rings in the trunk.



Vehicle with through-loading feature in the rear bench seat

- ① Cargo tie-down rings

Bag hook

WARNING

The bag hooks cannot restrain heavy objects or items of luggage. Objects or items of luggage could be flung around and thereby hit vehicle occupants when braking or abruptly changing directions. There is a risk of injury. Only hang light objects on the bag hooks. Never hang hard, sharp-edged or fragile objects on the bag hooks.

- ❗ The bag hook can bear a maximum load of 11lbs (5kg) and should not be used to secure a load.

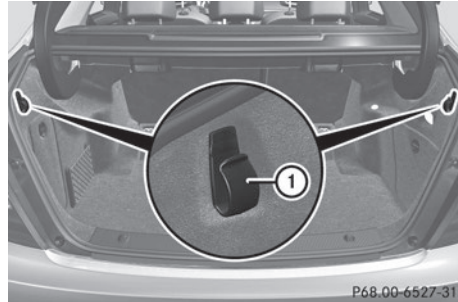

- ① Bag hook

Stowage well under the trunk floor

The TIREFIT kit, the vehicle tool kit, etc. are located in the stowage compartment.

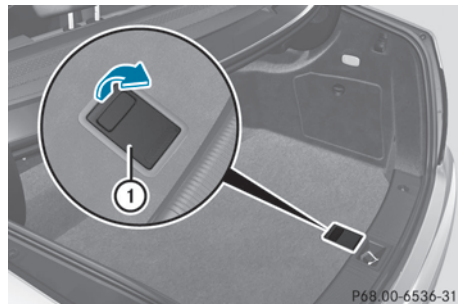

- ▶ **To open:** pull handle ① up.

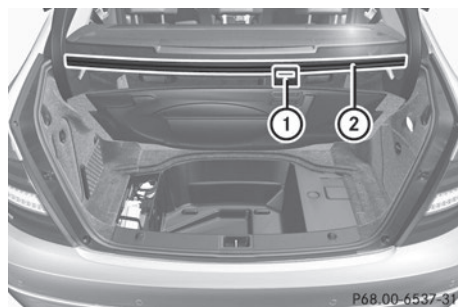

- ▶ Hook handle ① into rain trough ②.

- ❗ Unhook the handle before again before closing the trunk lid and clip it in securely to prevent the handle flap from protruding. Otherwise, you could damage the handle.

Roof carrier

Important safety notes

WARNING

When you load the roof, the center of gravity of the vehicle rises and the driving characteristics change. If you exceed the maximum roof load, the driving characteristics, as well as steering and braking, will be greatly impaired. There is a risk of an accident.

Never exceed the maximum roof load and adjust your driving style.

- !** Mercedes-Benz recommends that you only use roof carriers that have been tested and approved for Mercedes-Benz vehicles. This helps to prevent damage to the vehicle.

Position the load on the roof carrier in such a way that the vehicle will not sustain damage even when it is in motion.

Depending on the vehicle equipment, ensure that when the roof carrier is installed you can:

- raise the sliding sunroof fully
- open the panorama roof with power tilt/sliding panel fully
- open the trunk lid fully

- !** To avoid damaging or scratching the covers, do not use metallic or hard objects to open them.

The maximum roof load is 220 lbs(100 kg). An incorrectly secured roof carrier or roof load could become detached from the vehicle. Therefore, always comply with the installation instructions supplied by the manufacturer of the roof carrier.

Attaching the roof carrier

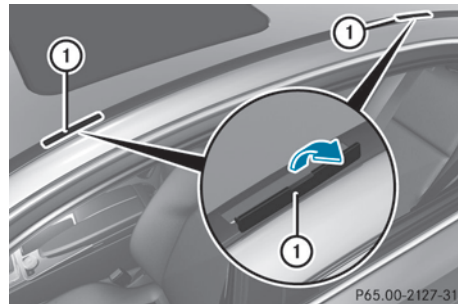

- ▶ Open covers ① carefully in the direction of the arrow.
- ▶ Fold covers ① upwards.
- ▶ Only secure the roof carrier to the anchorage points under covers ①.
- ▶ Observe the manufacturer's installation instructions.

Features

Cup holder

Important safety notes

- !** Only use the cup holders for containers of the right size and which have lids. The drinks could otherwise spill.

Cup holder in the front-compartment center console

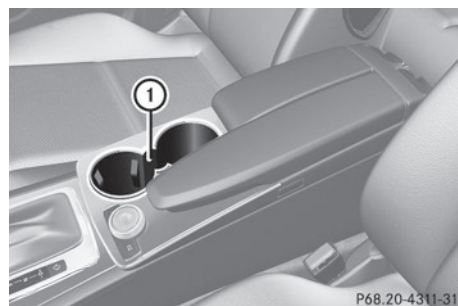

- ① Cup holder

Cup holder in the rear seat armrest

- ❗ Do not sit on or support your body weight on the rear seat armrest when it is folded down, as you could otherwise damage it.
- ❗ Close the cup holder before folding the rear seat armrest up. Otherwise, the cup holder could be damaged.

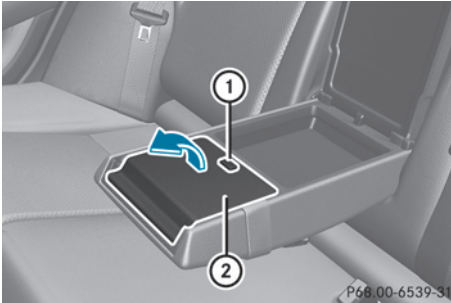

- ▶ Fold down the rear seat armrest.
- ▶ **To open:** raise the rear seat armrest cover.
- ▶ Press release catch (1).
- ▶ Cup holder (2) folds out forwards.
- ▶ Swing the rear seat armrest cover back down, if necessary.
- ▶ **To close:** raise the rear seat armrest cover.
- ▶ Swing cup holder (2) back until it engages.

Sun visors

Overview

WARNING

If the mirror cover of the vanity mirror is folded up when the vehicle is in motion, you could be blinded by incident light. There is a risk of an accident.

Always keep the mirror cover folded down while driving.

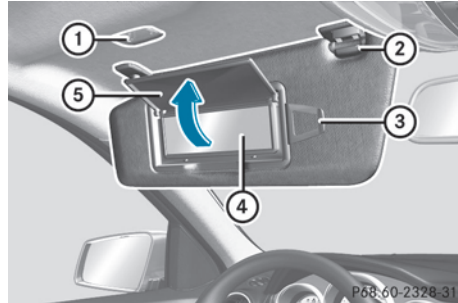

- ① Mirror light
- ② Bracket
- ③ Retaining clip, e.g. for a car park ticket
- ④ Vanity mirror
- ⑤ Mirror cover

Vanity mirror in the sun visor

Mirror light (1) only functions if the sun visor is clipped into bracket (2) and mirror cover (5) has been folded up.

Glare from the side

- ▶ Fold down the sun visor.
- ▶ Pull the sun visor out of retainer (2).
- ▶ Swing the sun visor to the side.

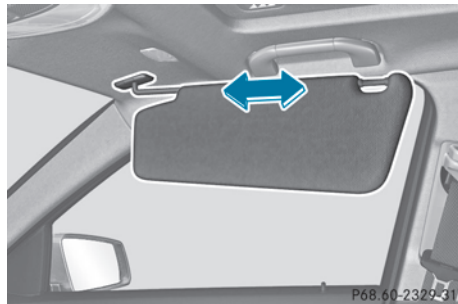

- ▶ Pull or push the sun visor in the direction of the arrow.

Roller sunblinds on the rear side windows

- ❗ Always guide the roller sunblind by hand. Do not let it snap back suddenly as this would damage the automatic roller mechanism.
- ❗ Do not drive the vehicle with the roller sunblind hooked in and the side windows opened simultaneously. The roller sunblind can jump out of the retainers and spring back suddenly when driving at high speeds, e.g. when driving on the freeway. This could damage the inertia reel. Therefore, either close the side window or retract the roller sunblind before driving at high speeds.

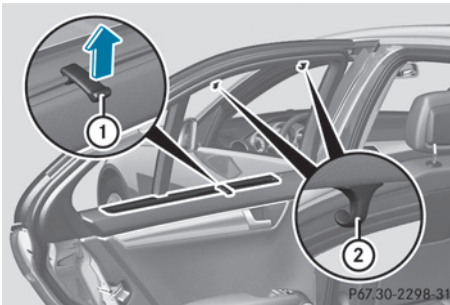

- ▶ **To extend:** pull the roller sunblind out by tab ① and hook it onto retainers ② at the top of the window.

Rear window roller sunblind (Sedan)

Important safety notes

WARNING

When extending or retracting, parts of the body could become trapped within the sweep of the roller sunblind. There is a risk of injury. When extending or retracting, make sure that no one has any parts of the body within the sweep of the roller sunblind. If someone becomes trapped, briefly press the button again. The opening or closing procedure will be stopped.

- ❗ Make sure that the roller sunblind can move freely. Otherwise, the roller sunblind or other objects could be damaged.

Extending/retracting the roller sunblind



- ▶ Turn the SmartKey to position 2 in the ignition lock (▷ page 147).
- ▶ **To extend or retract:** briefly press button ①. The roller sunblind fully extends or fully retracts.
- ▶ **To stop:** briefly press button ① again. The roller sunblind stops briefly and moves back into the out-of-use position.

Ashtray

Front ashtray

- ❗ The stowage space under the ashtray is not heat resistant. Before placing lit cigarettes in the ashtray, make sure that the ashtray is properly engaged. Otherwise, the stowage space could be damaged.
- i You can remove the ashtray insert and use the resulting compartment for stowage.

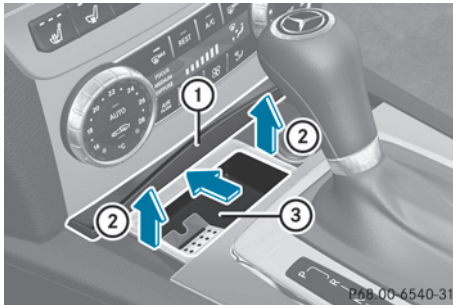

- ▶ **To open:** slide cover ① forwards until it engages.
- ▶ **To remove the insert:** hold insert ③ by the ribbing at the sides and lift it up ② and out.
- ▶ **To re-install the insert:** press insert ③ into the holder until it engages.
- ▶ **To close:** briefly press cover ① at the front. The cover moves back.

Rear-compartment ashtray

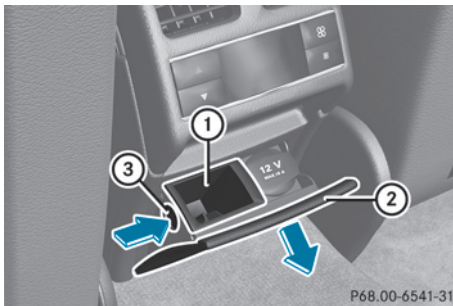

- ▶ **To open:** pull cover ② out by its top edge.
- ▶ **To remove the insert:** press release button ③ and lift the insert up and out.
- ▶ **To install the insert:** install insert ① from above into the holder and press down into the holder until it engages.

Cigarette lighter

⚠ WARNING

You can burn yourself if you touch the hot heating element or the socket of the cigarette lighter.

In addition, flammable materials can ignite if:

- the hot cigarette lighter falls
- a child holds the hot cigarette lighter to objects, for example

There is a risk of fire and injury.

Always hold the cigarette lighter by the knob. Always make sure that the cigarette lighter is out of reach of children. Never leave children unsupervised in the vehicle.

Your attention must always be focused on the traffic conditions. Only use the cigarette lighter when road and traffic conditions permit.

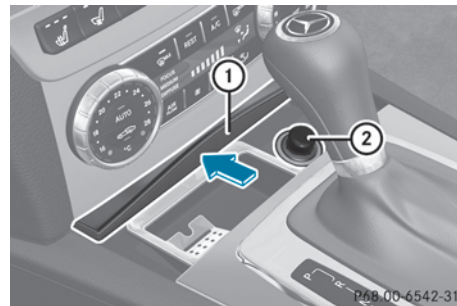

- ▶ Turn the SmartKey to position 2 in the ignition lock (▷ page 147).
- ▶ **To open:** slide cover ① forwards until it engages.
- ▶ Press in cigarette lighter ②. Cigarette lighter ② will pop out automatically when the heating element is red-hot.
- ▶ **To close:** briefly press cover ① at the front. The cover moves back.

12 V sockets

General notes

The sockets can be used for accessories with a maximum draw of 180 W (15 A).

Accessories include such items as lamps or chargers for mobile phones.

If you use the sockets for long periods when the engine is switched off, the battery may discharge.

- ▶ Turn the SmartKey to position **1** in the ignition lock (▷ page 147).

i An emergency cut-out ensures that the on-board voltage does not drop too low. If the on-board voltage is too low, the power to the sockets is automatically cut. This ensures that there is sufficient power to start the engine.

Socket in the rear-compartment center console

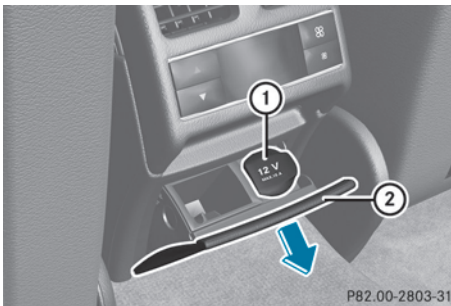

- ▶ Pull cover **(2)** out by its top edge.
- ▶ Lift up the cover of socket **(1)**.

115 V socket

Important safety notes

⚠ DANGER

When a suitable device is connected, the 115 V power socket will be carrying a high voltage. You could receive an electric shock if the connector cable or the 115 V power

socket is pulled out of the trim or is damaged or wet. There is a risk of fatal injury.

- Use only connector cables that are dry and free of damage.
- When the ignition is off, make sure that the 115 V power socket is dry.
- Have the 115 V power socket checked or replaced immediately at a qualified specialized workshop if it is damaged or has been pulled out of the trim.
- Never plug the connector cable into a 115 V power socket that is damaged or has been pulled out of the trim.

⚠ DANGER

If you reach into the power socket or plug inappropriate devices into the power socket, you could receive an electric shock. There is a risk of fatal injury.

Only connect appropriate devices to the power socket.

- ❗ Note that work and repairs on the 115 V power socket should only be carried out by qualified specialist personnel.

General notes

115 V power socket **(1)** provides an alternating voltage of 115 V so that small electronic devices can be connected. These devices, such as games consoles, chargers and laptops, should not consume more than a maximum of 150 watts altogether.

Requirements for operation of these devices:

- the electronic device that you connect has a suitable connector and conforms to standards specific to the country you are in.
- the plug of the electronic device is plugged into 115 V power socket **(1)**.
- the maximum wattage of the device to be connected must not exceed 150 watts.

- the on-board power supply is within a permissible voltage range.
- the 12 V sockets in the rear compartment are operational (▷ page 271).

Using the 115 V power socket

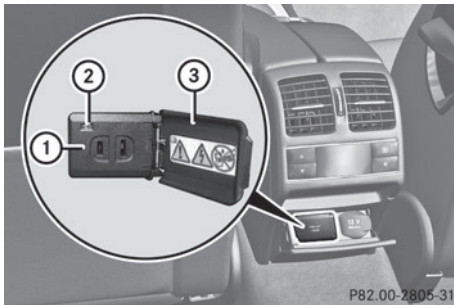

Stowage and features

- ▶ **To switch on:** switch the ignition on.
- ▶ Open flap ③.
- ▶ Insert the plug of the electronic device into 115 V power socket ①. Indicator lamp ② lights up.
- ▶ **To switch off:** remove the connector from 115 V socket ①. Ensure that you do not pull on the cord.

Problems with the 115 V power socket

Problem	Possible causes/consequences and ► Solutions
The warning lamp on the 115 V power socket is not lit.	<p>The on-board voltage is too low because the battery is too weak.</p> <ul style="list-style-type: none"> ► Start the engine. <p>or</p> <ul style="list-style-type: none"> ► Charge the battery (▷ page 304). <p>If the indicator lamp still does not light up:</p> <ul style="list-style-type: none"> ► Visit a qualified specialist workshop.
	<p>The temperature of the DC/AC converter is temporarily too high.</p> <ul style="list-style-type: none"> ► Remove the electronic device connector from the 115 V socket. ► Let the DC/AC converter cool down. <p>If the indicator lamp still does not light up after cooling down the converter:</p> <ul style="list-style-type: none"> ► Visit a qualified specialist workshop.
	<p>You have connected a small electronic device that has a constant nominal power of less than 150 W, but a very high switch-on current. This device will not work. If you connect such a device, the 115 V power socket will not supply it with power.</p> <ul style="list-style-type: none"> ► Connect a suitable device.

mbrace

General notes

You must have a license agreement to activate the mbrace service. Make sure that your system is activated and operational. To log in, press the  MB Info call button. If any of the steps mentioned are not carried out, the system may not be activated.

If you have questions about the activation, contact one of the following telephone hotlines:

- **USA:** Mercedes-Benz Customer Assistance Center at
1-800-FOR-MERCEDES (1-800-367-6372)
or 1-866-990-9007
- **Canada:** Customer Service at
1-888-923-8367

Shortly after successfully registering with the service, a user ID and password will be sent to you by post.



USA only: you can use this password to log onto the mbrace area under "Owners Online" at <http://www.mbusa.com>.

The system is available if:

- it has been activated and is operational
 - the corresponding mobile phone network is available for transmitting data to the Customer Center
 - a service subscription is available
 - the starter battery is sufficiently charged
- i** Determining the location of the vehicle on a map is only possible if:
- GPS reception is available.
 - the vehicle position can be forwarded to the Customer Assistance Center.

The mbrace system

To adjust the volume during a call, proceed as follows:

- ▶ Press the  or  button on the multifunction steering wheel.

or

- ▶ Use the volume controller of the audio system/COMAND.

The system offers various services, e.g:





- Automatic and manual emergency call
- Roadside Assistance call
- MB Info call

USA only: you can find information and a description of all available features under "Owners Online" at <http://www.mbusa.com>.

System self-test

After you have switched on the ignition, the system carries out a self-diagnosis.

A malfunction in the system has been detected if one of the following occurs:

- The indicator lamp in the SOS button does not come on during the system self-test.
- The indicator lamp in the  Roadside Assistance button does not light up during self-diagnosis of the system.
- The indicator lamp in the  MB Info call button does not light up during self-diagnosis of the system.
- The indicator lamp in one or more of the following buttons continues to light up red after the system self-diagnosis:
 - SOS button
 -  Roadside Assistance call button
 -  MB Info call button
- After the system self-diagnosis, the **Inoperative** or **Service Not Activated** message appears in the multifunction display.

If a malfunction is indicated as outlined above, the system may not operate as

expected. In the event of an emergency, help will have to be summoned by other means.

Have the system checked at the nearest authorized Mercedes-Benz Center or contact the following service hotlines:

- **USA:** Mercedes-Benz Customer Assistance Center at 1-800-FOR-MERcedes (1-800-367-6372) or 1-866-990-9007
- **Canada:** Customer Service at 1-888-923-8367

Emergency call

Important safety notes

WARNING

It can be dangerous to remain in the vehicle, even if you have pressed the SOS button in an emergency if:

- you see smoke inside or outside of the vehicle, e.g. if there is a fire after an accident
- the vehicle is on a dangerous section of road
- the vehicle is not visible or cannot easily be seen by other road users, particularly when dark or in poor visibility conditions

There is a risk of an accident and injury.

Leave the vehicle immediately in this or similar situations as soon as it is safe to do so. Move to a safe location along with other vehicle occupants. In such situations, secure the vehicle in accordance with national regulations, e.g. with a warning triangle.

You must have a license agreement to activate the mbrace service. Make sure that your system is activated and operational. To register, press the  MB Info call button. If any of the steps mentioned are not carried out, the system may not be activated.

If you have questions about the activation, contact one of the following telephone hotlines:

- **USA:** Mercedes-Benz Customer Assistance Center at
1-800-FOR-MERCEdes (1-800-367-6372)
or 1-866-990-9007
- **Canada:** Customer Service at
1-888-923-8367

General notes

An emergency call is dialed automatically if an air bag or Emergency Tensioning Device is triggered.

- ❗ You cannot end an automatically triggered emergency call yourself.

An emergency call can also be initiated manually.

As soon as the emergency call has been initiated, the indicator lamp in the SOS button flashes. The multifunction display shows the **Connecting Call** message.

The audio output is muted.

Once the connection has been made, the **Call Connected** message appears in the multifunction display.

All important information on the emergency is transmitted, for example:

- Current location of the vehicle (as determined by the GPS system)
- Vehicle identification number
- Information on the severity of the accident

Shortly after the emergency call has been initiated, a voice connection is automatically established between the Customer Assistance Center and the vehicle occupants.

- If the vehicle occupants respond, the Mercedes-Benz Customer Assistance Center attempts to get more information on the emergency.
- If there is no response from the vehicle occupants, an ambulance is immediately sent to the vehicle.

If no voice connection can be established to the Mercedes-Benz Customer Assistance Center, the system has been unable to initiate an emergency call.

This can occur, for example, if the relevant mobile phone network is not available. The indicator lamp in the SOS button flashes continuously.

The **Call Failed** message appears in the multifunction display and must be confirmed.

In this case, summon assistance by other means.

Making an emergency call

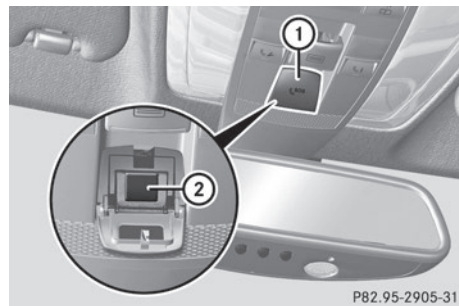

- ▶ **To initiate an emergency call manually:** press cover ① briefly to open.
- ▶ Press SOS button ② briefly. The indicator lamp in SOS button ② flashes until the emergency call is concluded.
- ▶ Wait for a voice connection to the Mercedes-Benz Customer Assistance Center.
- ▶ After the emergency call, close cover ①.

- ❗ If the mobile phone network is unavailable, mbrace will not be able to make the emergency call. If you leave the vehicle immediately after pressing the SOS button, you will not know whether mbrace placed the emergency call. In this case, always summon assistance by other means.

Roadside Assistance button

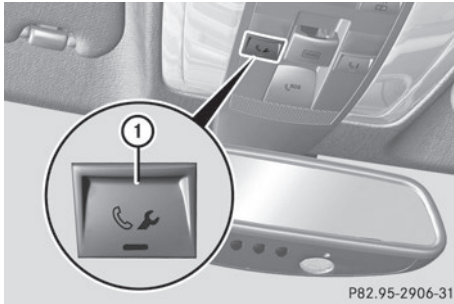

- ▶ Press Roadside Assistance button ①. This initiates a call to the Mercedes-Benz Customer Assistance Center. The indicator lamp in Roadside Assistance button ① flashes while the call is active. The multifunction display shows the **Connecting Call** message. The audio output is muted.

If a connection can be made, the **Call Connected** message appears in the multifunction display.

If a mobile phone network and GPS reception are available, the system transfers data to the Mercedes-Benz Customer Assistance Center, for example:

- Current location of the vehicle
- Vehicle identification number

- ❗ The audio system or COMAND display indicates that a call is active. During the call, you can change to the navigation menu by pressing the NAVI button on COMAND, for example.

Voice output is not available.

A voice connection is established between the Mercedes-Benz Customer Assistance Center and the vehicle occupants.

From the vehicle remote malfunction diagnosis, the Mercedes-Benz Customer Assistance Center can ascertain the nature of the problem (▷ page 279).

The Mercedes-Benz Customer Assistance Center either sends a qualified Mercedes-

Benz technician or makes arrangements for your vehicle to be transported to the nearest authorized Mercedes-Benz Center.

You may be charged for services such as repair work and/or towing.

Further details are available in your mbrace manual.

- ❗ The system has not been able to initiate a roadside assistance call, if:

- the indicator lamp for Roadside Assistance call button ① is flashing continuously.
- no voice connection to the Mercedes-Benz Customer Assistance Center was established.

This can occur if the relevant mobile phone network is not available, for example.

The **Call Failed** message appears in the multifunction display.

- ▶ **To end a call:** press the  button on the multifunction steering wheel.

or

- ▶ Press the corresponding button for ending a phone call on the audio system or on COMAND.

MB Info call button

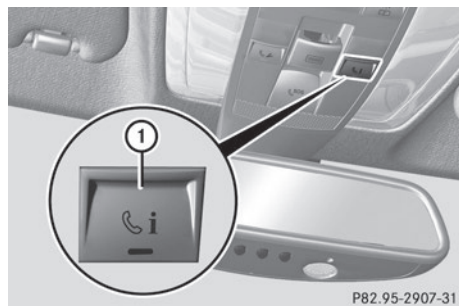

- ▶ Press MB Info call button ①. This initiates a call to the Mercedes-Benz Customer Assistance Center. The indicator lamp in MB Info call button ① flashes while the connection is being made. The multifunction display

shows the **Connecting Call** message. The audio system is muted.

If a connection can be made, the **Call Connected** message appears in the multifunction display.

If a mobile phone network and GPS reception are available, the system transfers data to the Mercedes-Benz Customer Assistance Center, for example:

- Current location of the vehicle
 - Vehicle identification number
- i** The audio system or COMAND display indicates that a call is active. During the call, you can change to the navigation menu by pressing the NAVI button on COMAND, for example.
- Voice output is not available.

A voice connection is established between the Mercedes-Benz Customer Assistance Center and the vehicle occupants.

You receive information about operating your vehicle, about the nearest authorized Mercedes-Benz Center and about other products and services from Mercedes-Benz.

USA only: you can find further information on the mbrace system under "Owners Online" at <http://www.mbusa.com>.

- i** The system has not been able to initiate an MB Info call, if:
- the indicator lamp in MB Info call button  is flashing continuously.
 - no voice connection to the Mercedes-Benz Customer Assistance Center was established.

This can occur if the relevant mobile phone network is not available, for example.

The **Call Failed** message appears in the multifunction display.

► **To end a call:** press the  button on the multifunction steering wheel.

or

► Press the corresponding button for ending a phone call on the audio system or on COMAND.

Call priority

When service calls are active, e.g. Roadside Assistance or MB Info calls, an emergency call can still be initiated. In this case, an emergency call will take priority and override all other active calls.

The indicator lamp of the respective button flashes until the call is ended.

An emergency call can only be terminated by the Mercedes-Benz Customer Assistance Center.

All other calls can be ended by pressing:

- the  button on the multifunction steering wheel
- the corresponding button on the audio system or on COMAND for ending a telephone call

- i** When a call is initiated, the audio system is muted. The mobile phone is no longer connected to COMAND. However, if you want to use your mobile phone, do so only when the vehicle is stationary and in a safe location.

Downloading destinations in COMAND

Downloading destinations

Destination Download gives you access to a data bank with over 15 million Points of Interest (POIs). These can be downloaded on the navigation system in your vehicle. If you know the destination, the address can be downloaded. Alternatively, you can obtain the location of Points of Interest (POIs)/ important destinations in the vicinity.

Furthermore, you can download routes with up to 20 way points.

You are prompted to confirm route guidance to the address entered.

The system calculates the route and subsequently starts the route guidance with the address entered.

- i** If you select **No**, the address can be saved in the address book.
- i** The destination download function is available if the relevant mobile phone network is available and data transfer is possible.
- i** The destination download function can only be used if the vehicle is equipped with a navigation system.

Route Assistance

This service is part of the mbrace PLUS Package and cannot be purchased separately.

- i** You can also use the Route Assistance function if your vehicle is not equipped with a navigation system.

Within the framework of this service, you receive a professional and reliable form of navigation support without having to leave your vehicle.

The customer service representative finds a suitable route depending on your vehicle's current position and the desired destination. You will then be guided live through the current route section.

Search & Send

"Search & Send" is a destination entry service. You can find further information on "Search & Send" in the separate COMAND operating instructions.

Vehicle remote opening

You can use the vehicle remote opening if you have unintentionally locked your vehicle and a replacement SmartKey is not available.

The vehicle can be opened by the Mercedes-Benz Customer Assistance Center.

The vehicle can be immediately opened remotely within four days of the ignition being turned off. After this time, the remote unlocking may be delayed by 15 to 60 minutes. After 30 days, the vehicle can no longer be opened remotely.

► Contact the following service hotlines:

- **USA:** Mercedes-Benz Customer Assistance Center at 1-800-FOR-MERCEdes (1-800-367-6372) or 1-866-990-9007

- **Canada:** Customer Service at 1-888-923-8367

You will be asked for your password.

► Return to your vehicle at the time agreed upon with the Mercedes-Benz Customer Assistance Center.

USA only: alternatively, the vehicle can be opened via:

- the Internet, under the "Owners Online" section
- the telephone application (e.g. iPhone®, Blackberry)

To do this, you will need your identification number and password.

- i** Vehicle remote opening is only possible if the corresponding mobile phone network is accessible.

Vehicle remote closing

The remote closing feature can be used when you have forgotten to lock the vehicle and you are no longer nearby.

The vehicle can then be locked by the Mercedes-Benz Customer Assistance Center.

The vehicle can be immediately remotely locked within four days of the ignition being turned off. After this time, the remote closing may be delayed by 15 to 60 minutes. After 30 days the vehicle can no longer be closed remotely.

► Contact the following service hotlines:

- **USA:** Mercedes-Benz Customer Assistance Center at

1-800-FOR-MERCEdes
(1-800-367-6372) or 1-866-990-9007

- **Canada:** Customer Service at 1-888-923-8367

You will be asked for your password.

The next time you are inside the vehicle and you switch on the ignition, the **Doors Locked Remotely** message appears in the multifunction display.

USA only: alternatively, the vehicle can be locked via:

- the Internet, under the "Owners Online" section
- the telephone application (e.g. iPhone®, Blackberry)

To do this, you will need your identification number and password.

- **i** The vehicle remote closing feature is available when the relevant mobile phone network is available and data connection is possible.

Stolen vehicle recovery service

If your vehicle has been stolen:

- ▶ Notify the police.
The police will issue a numbered incident report.
- ▶ This number will be forwarded to the Mercedes-Benz Customer Assistance Center together with your PIN.
The Mercedes-Benz Customer Assistance Center then tries to locate the system. The Mercedes-Benz Customer Assistance Center contacts you and the local law enforcement agency if the vehicle is located.

However, only the law enforcement agency is informed of the location of the vehicle.

- **i** If the anti-theft alarm system is activated for longer than 30 seconds, the Mercedes-Benz Customer Assistance Center is automatically informed.

Vehicle remote malfunction diagnosis

With the vehicle remote malfunction diagnosis (Vehicle Health Check), the Customer Assistance center can provide improved support for problems with your vehicle. During an existing call, vehicle data is transferred to the Customer Assistance center. The customer service representative can use the received data to decide what kind of assistance is required. You are then, for example, guided to the nearest authorized Mercedes-Benz Center or a recovery vehicle is called.

If vehicle data needs to be transferred during an MB Info call or a Roadside Assistance call, this is initiated by the Customer Assistance center. You will see the **Roadside Assistance Connected** message in the COMAND display. If the vehicle remote malfunction diagnosis can be started, the **Request for vehicle diagnosis received. Start vehicle diagnosis?** message appears in the display.

- ▶ Confirm the message with **Yes**.
- ▶ When the **Vehicle Diagnosis Please start ignition** message appears, turn the SmartKey to position **2** in the ignition lock (▷ page 147).
- ▶ When the **Please follow the instructions received by phone and move your vehicle to a safe position.** message appears, follow the customer service representative's instructions.
The message in the display disappears.
If you select **Cancel**, the vehicle remote malfunction diagnosis is canceled completely.
The vehicle operating state check begins.
You will see the **Vehicle diagnosis activated.** message.

When the diagnosis is completed, the **Send vehicle diagnostics data//(Voice connection may be//interrupted during data transfer)** message appears.

The vehicle data can now be sent to the Customer Assistance center.

- ▶ Press **OK** to confirm the message. The voice connection with the Customer Assistance center is terminated. You will see the **Vehicle Diagnosis: Transferring data...** message. The vehicle data is sent to the Customer Assistance center.

Depending on what the customer service representative agreed with you, the voice connection is re-established after the transfer is complete. If necessary, you will be contacted at a later time by another means, e.g. by e-mail or phone.

Further functions of the vehicle remote malfunction diagnosis include, for example:

- transfer of service data to the Customer Assistance center. If a service is overdue, the COMAND display shows a message about various special offers at your workshop.
- monthly status information e-mail on oil level, air pressure, maintenance, brakes, etc. If applicable, you will receive information on special offers in the e-mail. USA only: this information can also be called up under "Owners Online" at <http://www.mbUSA.com>.

Information on the data stored in the vehicle (> page 27).

Information on Roadside Assistance (> page 23).

Downloading routes

Downloading routes allows you to transfer and save predefined routes in the navigation system. To do this, an SD memory card must be inserted into the COMAND system. If no SD memory card is inserted, you must insert the card into the card slot on the COMAND system before saving.

A route can be prepared and sent either by a customer service representative or via the mbrace portal on the Internet.

Each route can include up to 20 way points. Once a route has been received by the navigation system, you will see the **<route name> has been saved to memory card. Do you want to start route guidance?** message in the COMAND display. The route is saved to the SD memory card.

- ▶ **To start route guidance:** select **Yes**. An overview of the route is shown in the display.
 - ❗ If you select **No**, the saved route can be called up later via the navigation menu.
- ▶ Select **Start**. Route guidance is started.
 - ❗ Downloaded and saved data can be called up again in COMAND. You can find further information in the separate COMAND Operating Instructions.

Speed alert

You can define the upper speed limit, which must not be exceeded by the vehicle.

If this selected speed is exceeded by the vehicle, a message will be sent to the Customer Assistance center. The Customer Assistance center then forwards this information to you.

You can select the way in which you receive this information beforehand. Possible options include text message, e-mail or an automated call.

The data you receive contains the following information:

- the location where the speed limit was exceeded
- the time at which the speed limit was exceeded
- the selected speed limit which was exceeded

Geo fencing

Geo fencing allows you to select areas which the vehicle should not enter or leave. You will be informed if the vehicle crosses the boundaries of the selected areas. You can select the way in which you receive this information beforehand. Possible options include text message, e-mail or an automated call.

The area can be determined as either a circle or a polygon with a maximum of ten corners. You can specify up to ten areas simultaneously. Different settings are possible for each area.

USA only: these settings can be called up under "Owners Online" at <http://www.mbusa.com>.

Alternatively, you can trigger an MB Info call and inform the customer service representative that you wish to activate geo fencing.

Currently inactive areas can be activated by text message.

Triggering the vehicle alarm

With this function, you can trigger the vehicle's panic alarm via text message. An alarm sounds and the exterior lighting flashes. Depending on the setting, the panic alarm lasts five or ten seconds. Afterwards, the alarm switches off.

Garage door opener

Important safety notes

WARNING

When you operate or program the garage door with the integrated garage door opener, persons in the range of movement of the garage door can become trapped or struck by the garage door. There is a risk of injury.

When using the integrated garage door opener, always make sure that nobody is

within the range of movement of the garage door.

WARNING

Combustion engines emit poisonous exhaust gases such as carbon monoxide. Inhaling these exhaust gases leads to poisoning. There is a risk of fatal injury. Therefore never leave the engine running in enclosed spaces without sufficient ventilation.

The HomeLink® garage door opener integrated in the rear-view mirror allows you to operate up to three different door and gate systems.

Use the integrated garage door opener only on garage doors that:

- have safety stop and reverse features and
- meet current U.S. federal safety standards

When programming a garage door opener, park the vehicle outside the garage.

-  Certain garage door drives are incompatible with the integrated garage door opener. If you have difficulty programming the integrated garage door opener, contact an authorized Mercedes-Benz Center.

Alternatively, you can call the following telephone assistance services:

- **USA:** Mercedes-Benz Customer Assistance Center at 1-800-FOR-MERCEdes
- **Canada:** Customer Service at 1-800-387-0100
- HomeLink® hotline 1-800-355-3515 (free of charge)

More information on HomeLink® and/or compatible products is also available online at <http://www.homelink.com>.

-  Notes on the declaration of conformity (▷ page 25).

USA: FCC ID: CB2HMIHL4

Canada: IC: 279B-HMIHL4

Programming

Programming buttons

Observe the "Important safety notes" (> page 281).

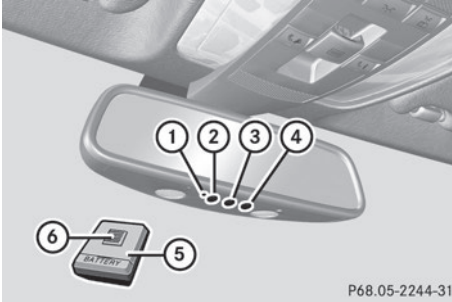

Integrated garage door opener in the rear-view mirror

Garage door remote control ⑤ is not part of the integrated garage door opener.

- ▶ The first time before programming, clear the integrated garage door opener memory (> page 284).
- ▶ Turn the SmartKey to position **2** in the ignition lock.
- ▶ Press and hold one of buttons ② to ④ on the integrated garage door opener. After a short time, indicator lamp ① lights up yellow.
 - ❗ Indicator lamp ① lights up yellow as soon as button ②, ③ or ④ is programmed for the first time. If the selected button has already been programmed, indicator lamp ① will only light up yellow after ten seconds have elapsed.
- ▶ Release button ②, ③ or ④. Indicator lamp ① flashes yellow.
- ▶ Point garage door remote control ⑤ towards buttons ② to ④ on the rear-view mirror at a distance of 2 to 8 inches (5 to 20 cm).
 - ❗ The required distance between remote control ⑤ and the integrated garage door opener depends on the garage door drive system. Several attempts might be

necessary. You should test every position for at least 25 seconds before trying another position.

- ▶ Press and hold button ⑥ on remote control ⑤ until indicator lamp ① lights up green. If indicator lamp ① lights up green or flashes, then programming has been successful.
- ▶ Release button ⑥ on remote control ⑤ for the garage door drive system.
- ▶ If indicator lamp ① lights up red: repeat the programming procedure for the corresponding button on the rear-view mirror. When doing so, vary the distance between remote control ⑤ and the rear-view mirror.

❗ If the indicator lamp flashes green after successful programming, the garage door system is using a rolling code. After programming, you must synchronize the garage door opener integrated in the rear-view mirror with the receiver of the garage door system.

Synchronizing the rolling code

Observe the "Important safety notes" (> page 281).

Your vehicle must be within reach of the garage door or exterior gate drive. Make sure that neither your vehicle nor any persons/objects are present within the sweep of the door or gate.

- ▶ Turn the SmartKey to position **2** in the ignition lock.
- ▶ Press the program button of the door or gate drive (see the door or gate drive operating instructions, e.g. under "programming of additional remote controls").

- i** Usually, you now have 30seconds to initiate the next step.
- ▶ Press previously programmed button ②, ③ or ④ of the integrated garage door opener until the door closes. The rolling code synchronization is then complete.

Notes on programming the remote control

Canadian radio frequency laws require a "break" (or interruption) of the transmission signals after broadcasting for a few seconds. Therefore, these signals may not last long enough for the integrated garage door opener. The signal is not recognized during programming. Comparable with Canadian law, some U.S. garage door openers also feature a "break".

Proceed as follows:

- if you live in Canada
- if you have difficulties programming the garage door opener (regardless of where you live) when using the programming steps
- ▶ Press and hold one of buttons ② to ④ on the integrated garage door opener. After a short time, indicator lamp ① lights up yellow.
- ▶ Release the button. Indicator lamp ① flashes yellow.
- ▶ Press button ⑥ of garage door remote control ⑤ for two seconds, then release it for two seconds.
- ▶ Press button ⑥ again for two seconds.
- ▶ Repeat this sequence on button ⑥ of remote control ⑤ until indicator lamp ① lights up green. If indicator lamp ① turns red, repeat the process.
- ▶ Continue with the other programming steps (see above).

Problems when programming

If you are experiencing problems programming the integrated garage door opener on the rear-view mirror, take note of the following instructions:

- Check the transmitter frequency of garage door drive remote control ⑤. This can usually be found on the back of the remote control. The integrated garage door opener is compatible with devices that have units which operate in the frequency range of 280to 433MHz.
- Replace the batteries in garage door remote control ⑤. This increases the likelihood that garage door remote control ⑤ will transmit a strong and precise signal to the integrated garage door opener in the rear-view mirror.
- When programming, hold remote control ⑤ at varying distances and angles from the button that you are programming. Try various angles at a distance between 2and 12 inches (5to 30 cm) or at the same angle but at varying distances.
- If another remote control for the same garage door drive is available, repeat the same programming steps with this remote control. Before performing these steps, make sure that new batteries have been installed in garage door drive remote control ⑤.
- Note that some remote controls only transmit for a limited amount of time (the indicator lamp on the remote control goes out). Press button ⑥ on remote control ⑤ again before transmission ends.
- Align the antenna cable of the garage door opener unit. This can improve signal reception/transmission.

Opening/closing the garage door

After it has been programmed, the integrated garage door opener performs the function of the garage door system remote control.

Please also read the operating instructions for the garage door system.

- ▶ Turn the SmartKey to position **2** in the ignition lock.
- ▶ Press button **②**, **③** or **④** which you have programmed to operate the garage door. Garage door system with a fixed code: indicator lamp **①** lights up green. Garage door system with a rolling code: indicator lamp **①** flashes green.

- i** The transmitter will transmit a signal as long as the button is pressed. The transmission is halted after a maximum of ten seconds and indicator lamp **①** lights up yellow. Press button **②**, **③** or **④** again if necessary.

Clearing the memory

- ▶ Turn the SmartKey to position **2** in the ignition lock.
- ▶ Press buttons **②** and **④**. The indicator lamp lights up yellow.
- ▶ Press and hold buttons **②** and **④** until the indicator lamp turns green.

- i** Make sure that you clear the memory of the integrated garage door opener before selling the vehicle.

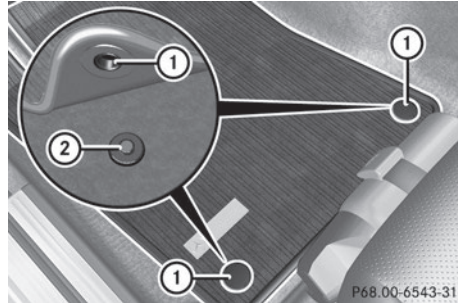

- ▶ Slide the seat backwards.
- ▶ **To install:** place the floor mat in the footwell.
- ▶ Press studs **①** onto retainers **②**.
- ▶ **To remove:** pull the floor mat off retainers **②**.
- ▶ Remove the floor mat.

Floor mat on the driver's side

WARNING

Objects in the driver's footwell can restrict the pedal travel or obstruct a depressed pedal. The operating and road safety of the vehicle is jeopardized. There is a risk of an accident. Make sure that all objects in the vehicle are stowed correctly, and that they cannot enter the driver's footwell. Install the floor mats securely and as specified in order to ensure sufficient clearance for the pedals. Do not use loose floor mats and do not place floor mats on top of one another.

Useful information	286
ASSYST PLUS	286
Engine compartment	287
Care	291

Useful information

- i** This Operator's Manual describes all models and all standard and optional equipment of your vehicle available at the time of publication of the Operator's Manual. Country-specific differences are possible. Please note that your vehicle may not be equipped with all features described. This also applies to safety-related systems and functions.
- i** Read the information on qualified specialist workshops: (> page 25).

ASSYST PLUS

Service messages

The ASSYST PLUS service interval display informs you of the next service due date. Information on the type of service and service intervals (see the separate Maintenance Booklet).

You can obtain further information from an authorized Mercedes-Benz Center or at <http://www.mbusa.com> (USA only).

- i** The ASSYST PLUS service interval display does not show any information on the engine oil level. Observe the notes on the engine oil level (> page 288).

The multifunction display shows a service message for several seconds, e.g.:

- Service A in .. Days
- Service A Due
- Service A Exceeded by ... Days

Depending on the operating conditions of the vehicle, the remaining time or distance until the next service due date is displayed.

The letter **A** or **B**, possibly in connection with a number or another letter, shows the type of service. **A** stands for a minor service and **B** for a major service.



You can obtain further information from an authorized Mercedes-Benz Center.

The ASSYST PLUS service interval display does not take into account any periods of time during which the battery is disconnected.





Maintaining the time-dependent service schedule:

- ▶ Note down the service due date displayed in the multifunction display before disconnecting the battery.
- or
- ▶ After reconnecting the battery, subtract the battery disconnection periods from the service date shown on the display.

Hiding a service message

- ▶ Press the  or  button on the steering wheel.

Displaying service messages

- ▶ Switch on the ignition.
- ▶ Press the  or  button on the steering wheel to select the **Service** menu.
- ▶ Press the  or  button to select the **ASSYST PLUS** submenu and confirm by pressing the  button. The service due date appears in the multifunction display.

Information about Service

Resetting the ASSYST PLUS service interval display

- i** If the ASSYST PLUS service interval display has been inadvertently reset, this setting can be corrected at a qualified specialist workshop.

Have service work carried out as described in the Maintenance Booklet. This may otherwise lead to increased wear and

damage to the major assemblies or the vehicle.

A qualified specialist workshop, e.g. an authorized Mercedes-Benz Center, will reset the ASSYST PLUS service interval display after the service work has been carried out. You can also obtain further information on maintenance work, for example.

Special service requirements

The specified maintenance interval takes only the normal operation of the vehicle into account. Under arduous operating conditions or increased load on the vehicle, maintenance work must be carried out more frequently, for example:

- regular city driving with frequent intermediate stops
- if the vehicle is primarily used to travel short distances
- use in mountainous terrain or on poor road surfaces
- if the engine is often left idling for long periods

Under these or similar conditions, have, for example, the air filter, engine oil and oil filter replaced or changed more frequently. Under arduous operating conditions, the tires must be checked more often. Further information can be obtained at a qualified specialist workshop, e.g. an authorized Mercedes-Benz Center.

Driving abroad

An extensive Mercedes-Benz Service network is also available in other countries. You can obtain further information from any authorized Mercedes-Benz Center.

Engine compartment

Hood

Important safety notes

WARNING

If the hood is unlatched, it may open up when the vehicle is in motion and block your view. There is a risk of an accident.

Never unlatch the hood while driving.

WARNING

When opening and closing the hood, it may suddenly fall into the closed position. There is a risk of injury to persons within range of movement of the hood.

Open and close the hood only when no one is within its range of movement.

WARNING

Opening the hood when the engine is overheated or when there is a fire in the engine compartment could expose you to hot gases or other service products. There is a risk of injury.

Let an overheated engine cool down before opening the hood. If there is a fire in the engine compartment, keep the hood closed and contact the fire department.

WARNING

The engine compartment contains moving components. Certain components, such as the radiator fan, may continue to run or start again suddenly when the ignition is off. There is a risk of injury.

If you need to do any work inside the engine compartment,

- switch off the ignition
- never reach into the area where there is a risk of danger from moving components, such as the fan rotation area
- keep clothing away from moving parts

⚠ WARNING

The ignition system and the fuel injection system work under high voltage. If you touch components which are under voltage, you could get an electric shock. There is a risk of injury.

Never touch components of the ignition system or fuel injection system when the ignition is switched on.

Opening the hood**⚠ WARNING**

Certain components in the engine compartment, such as the engine, radiator and parts of the exhaust system, can become very hot. Working in the engine compartment poses a risk of injury.

Where possible, let the engine cool down and touch only the components described in the following.

⚠ WARNING

When the hood is open and the windshield wipers are set in motion, you can be injured by the wiper linkage. There is a risk of injury. Always switch off the windshield wipers and the ignition before opening the hood.

- ❗ Make sure that the windshield wipers are not folded away from the windshield. You could otherwise damage the windshield wipers or the hood.

- ▶ Make sure that the windshield wipers are turned off.

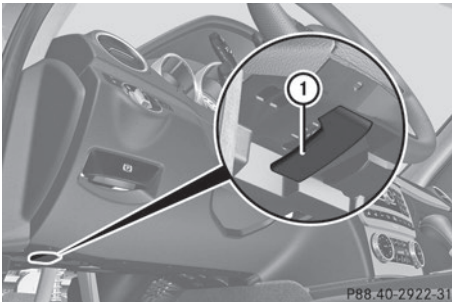

P88.40-2922-31

- ▶ Pull release lever ① on the hood. The hood is released.

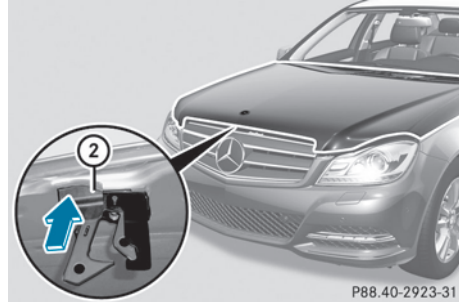

P88.40-2923-31

- ▶ Reach into the gap, pull hood catch handle ② up and lift the hood.

If you lift the hood by approximately 15 in (40 cm), the hood is opened and held open automatically by the gas-filled strut.

Closing the hood

- ▶ Lower the hood and let it fall from a height of approximately 8 in (20 cm).
- ▶ Check that the hood has engaged properly. If the hood can be raised slightly, it is not properly engaged. Open it again and close it with a little more force.

Engine oil**General notes on the oil level**

Depending on the driving style, the vehicle consumes up to 0.9 US qt (0.8 liters) of oil over a distance of 600 miles (1,000 km). The oil consumption may be higher than this when the vehicle is new or if you frequently drive at high engine speeds.

Depending on the engine, the oil dipstick may be in a different location.

When checking the oil level:

- park the vehicle on a level surface.
- the engine should be switched off for approximately five minutes if the engine is at normal operating temperature.
- if the engine is not at normal operating temperature, e.g. if the engine was only started briefly: wait about 30 minutes before carrying out the measurement.

Checking the oil level using the oil dipstick

WARNING

Certain components in the engine compartment, such as the engine, radiator and parts of the exhaust system, can become very hot. Working in the engine compartment poses a risk of injury.

Where possible, let the engine cool down and touch only the components described in the following.

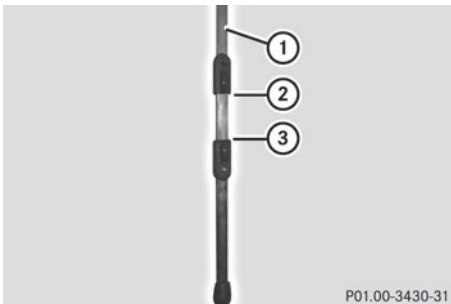
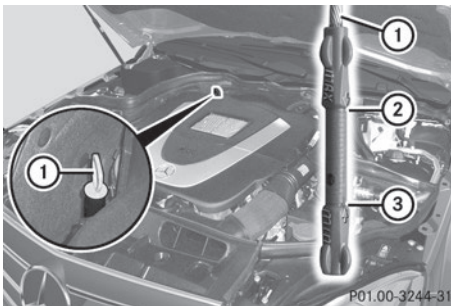

Example: AMG vehicles

- ▶ Park the vehicle on a level surface.

To check the oil level with the engine at operating temperature, switch the engine off and wait for approximately five minutes.

- ▶ Pull oil dipstick ① out of the dipstick guide tube.
- ▶ Wipe off oil dipstick ①.
- ▶ Slowly slide oil dipstick ① into the guide tube to the stop, and take it out again. If the level is between MIN mark ③ and MAX mark ②, the oil level is correct.
- ▶ If the oil level has dropped to MIN mark ③ or below, add 1.1 US qt (1.0 liter) engine oil.

Adding engine oil

WARNING

Certain components in the engine compartment, such as the engine, radiator and parts of the exhaust system, can become very hot. Working in the engine compartment poses a risk of injury.

Where possible, let the engine cool down and touch only the components described in the following.

WARNING

If engine oil comes into contact with hot components in the engine compartment, it may ignite. There is a risk of fire and injury. Make sure that engine oil is not spilled next to the filler neck. Let the engine cool down and thoroughly clean the engine oil off the components before starting the engine.

Environmental note

When adding oil, take care not to spill any. If oil enters the soil or waterways, it is harmful to the environment.

- ! Only use engine oils and oil filters that have been approved for vehicles with a service system. You can obtain a list of the engine oils and oil filters tested and approved in accordance with the Mercedes-Benz Specifications for Service

Products at any Mercedes-Benz Service center.

Damage to the engine or exhaust system is caused by the following:

- using engine oils and oil filters that have not been specifically approved for the service system
- replacing engine oil and oil filters after the interval for replacement specified by the service system has been exceeded
- using engine oil additives.

! Do not add too much oil. If the oil level is above the "max" mark on the dipstick, too much oil has been added. This can lead to damage to the engine or the catalytic converter. Have excess oil siphoned off.



Example: engine oil cap

- ▶ Turn cap ① counter-clockwise and remove it.
- ▶ Add engine oil.
If the oil level is at or below the MIN mark on the oil dipstick, add 1.1 US qt (1.0 l) of engine oil.
- ▶ Replace cap ① on the filler neck and turn clockwise.
Ensure that the cap locks into place securely.
- ▶ Check the oil level again with the oil dipstick (▷ page 289).

Further information on engine oil (▷ page 354).

Checking and adding other service products

Checking coolant level

⚠ WARNING

Certain components in the engine compartment, such as the engine, radiator and parts of the exhaust system, can become very hot. Working in the engine compartment poses a risk of injury.

Where possible, let the engine cool down and touch only the components described in the following.

⚠ WARNING

The engine cooling system is pressurized, particularly when the engine is warm. When opening the cap, you could be scalded by hot coolant spraying out. There is a risk of injury.

Let the engine cool down before opening the cap. Wear eye and hand protection when opening the cap. Open the cap slowly half a turn to allow pressure to escape.

Only check the coolant level when the vehicle is on a level surface and the engine has cooled down.

- ▶ Turn the SmartKey to position **2** in the ignition lock (▷ page 147).
On vehicles with KEYLESS-GO, press the Start/Stop button twice (▷ page 148).
- ▶ Check the coolant temperature display in the instrument cluster.
The coolant temperature must be below 158 °F (70 °C).

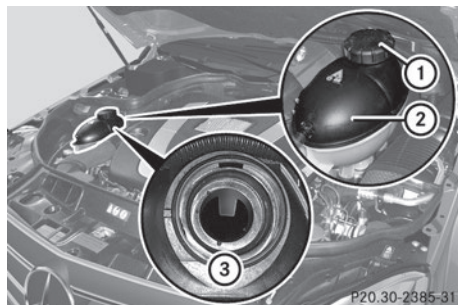

- ▶ Slowly turn cap ① half a turn counter-clockwise and allow excess pressure to escape.
- ▶ Turn cap ① further counter-clockwise and remove it.
If the coolant is at the level of marker bar ③ in the filler neck when cold, there is enough coolant in coolant expansion tank ②.
If the coolant level is approximately 0.6 in (1.5 cm) above marker bar ③ in the fuel filler neck when warm, there is enough coolant in expansion tank ②.
- ▶ If necessary, add coolant that has been tested and approved by Mercedes-Benz.
- ▶ Replace cap ① and turn it clockwise as far as it will go.

For further information on coolant, see (> page 356).

Adding washer fluid to the windshield washer system/headlamp cleaning system

WARNING

Certain components in the engine compartment, such as the engine, radiator and parts of the exhaust system, can become very hot. Working in the engine compartment poses a risk of injury.

Where possible, let the engine cool down and touch only the components described in the following.

WARNING

Windshield washer concentrate is highly flammable. If it comes into contact with hot engine components or the exhaust system it could ignite. There is a risk of fire and injury. Make sure that no windshield washer concentrate is spilled next to the filler neck.

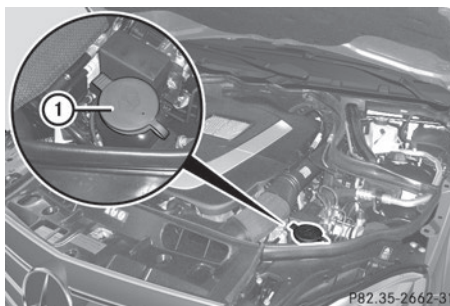

- ▶ **To open:** pull cap ① upwards by the tab.
- ▶ Add the premixed washer fluid.
- ▶ **To close:** press cap ① onto the filler neck until it engages.

The washer fluid reservoir is used for both the windshield washer system and the headlamp cleaning system.

If the washer fluid level drops below the recommended minimum of 1 liter, a message appears in the multifunction display prompting you to add washer fluid (> page 246).

Further information on windshield washer fluid/antifreeze (> page 357).

Care

General notes

- ❗ For cleaning your vehicle, do not use any of the following:

- dry, rough or hard cloths
- abrasive cleaning agents
- solvents
- cleaning agents containing solvents

Do not scrub.

Do not touch the surfaces or protective films with hard objects, e.g. a ring or ice scraper. You could otherwise scratch or damage the surfaces and protective film.

**Environmental note**

Dispose of empty packaging and cleaning cloths in an environmentally responsible manner.

- ❗ Do not park the vehicle for an extended period straight after cleaning it, particularly after having cleaned the wheels with wheel cleaner. Wheel cleaners could cause increased corrosion of the brake discs and brake pads/linings. For this reason, you should drive for a few minutes after cleaning. Braking heats the brake discs and the brake pads/linings, thus drying them. The vehicle can then be parked.

Regular care of your vehicle is a condition for retaining the quality in the long term.

Use care products and cleaning agents recommended and approved by Mercedes-Benz.

Exterior care**Automatic car wash****WARNING**

Braking efficiency is reduced after washing the vehicle. There is a risk of an accident.

After the vehicle has been washed, brake carefully while paying attention to the traffic conditions until full braking power is restored.

- ❗ If DISTRONIC PLUS or the HOLD function is activated, the vehicle brakes automatically in certain situations. To prevent damage to the vehicle, deactivate DISTRONIC PLUS and the HOLD function in the following or other similar situations:
 - when towing the vehicle
 - in the car wash
- ❗ Never clean your vehicle in a Touchless Automatic Car Wash as these use special cleaning agents. These cleaning agents can damage the paintwork or plastic parts.

- ❗ Make sure that the automatic transmission is in position **N** when washing your vehicle in a tow-through car wash. The vehicle could be damaged if the transmission is in another position.

- ❗ Make sure that:
 - the side windows and the sliding sunroof are fully closed.
 - the ventilation/heating is switched off (the OFF button has been pressed).
 - the windshield wiper switch is in position **0**.

Otherwise, the vehicle might be damaged.

You can wash the vehicle in an automatic car wash from the very start.

If the vehicle is very dirty, pre-wash it before cleaning it in an automatic car wash.

After using an automatic car wash, wipe off wax from the windshield and the wiper blades. This will prevent smears and reduce wiping noises caused by residue on the windshield.

Washing by hand

In some countries, washing by hand is only allowed at specially equipped washing bays. Observe the legal requirements in all countries concerned.

- ▶ Do not use hot water and do not wash the vehicle in direct sunlight.
- ▶ Use a soft sponge to clean.
- ▶ Use a mild cleaning agent, such as a car shampoo approved by Mercedes-Benz.
- ▶ Thoroughly hose down the vehicle with a gentle jet of water.
- ▶ Do not point the water jet directly towards the air inlet.
- ▶ Use plenty of water and rinse out the sponge frequently.
- ▶ Rinse the vehicle with clean water and dry thoroughly with a chamois.
- ▶ Do not let the cleaning agent dry on the paintwork.

When using the vehicle in winter, remove all traces of road salt deposits carefully and as soon as possible.

Power washers

WARNING

The water jet from a circular jet nozzle (dirt blasters) can cause invisible exterior damage to the tires or chassis components.

Components damaged in this way may fail unexpectedly. There is a risk of an accident.

Do not use power washers with circular jet nozzles to clean the vehicle. Have damaged tires or chassis components replaced immediately.

- !** Always maintain a distance of at least 11.8 in (30 cm) between the vehicle and the power washer nozzle. Information about the correct distance is available from the equipment manufacturer.

Move the power washer nozzle around when cleaning your vehicle.

Do not aim directly at any of the following:

- tires
- door gaps, roof gaps, joints, etc.
- electrical components
- battery
- connectors
- lights
- seals
- trim
- ventilation slots

Damaged seals or electrical components can lead to leaks or failures.

Cleaning the wheels

- !** Do not use acidic wheel cleaning products to remove brake dust. This could damage wheel bolts and brake components.
- !** Do not park the vehicle for an extended period straight after cleaning it, particularly after having cleaned the wheels with wheel

cleaner. Wheel cleaners could cause increased corrosion of the brake discs and brake pads/linings. For this reason, you should drive for a few minutes after cleaning. Braking heats the brake discs and the brake pads/linings, thus drying them. The vehicle can then be parked.

Cleaning the paintwork

Scratches, corrosive deposits, areas affected by corrosion and damage caused by inadequate care cannot always be completely repaired. In such cases, visit a qualified specialist workshop.

- ▶ Remove dirt immediately, where possible, while avoiding rubbing too hard.
- ▶ Soak insect remains with insect remover and rinse off the treated areas afterwards.
- ▶ Soak bird droppings with water and rinse off the treated areas afterwards.
- ▶ Remove coolant, brake fluid, tree resin, oils, fuels and greases by rubbing gently with a cloth soaked in petroleum ether or lighter fluid.
- ▶ Use tar remover to remove tar stains.
- ▶ Use silicone remover to remove wax.

- !** Do not affix:
 - stickers
 - films
 - magnetic plates or similar items
 to painted surfaces. You could otherwise damage the paintwork.

If water no longer forms "beads" on the paint surface, use the paint care products recommended and approved by Mercedes-Benz. This is the case approximately every three to five months, depending on the climate conditions and the care product used.

If the dirt has penetrated the paint surface or if the paintwork has become dull, then the paintwork should be cleaned. Use the cleaning product Paint Cleaner, which has been approved by Mercedes-Benz.

Do not use these care products in the sun or on the hood while the hood is hot.

- ▶ Use a suitable touch-up stick, e.g. MB Touch-Up Stick, to repair slight damage to the paintwork quickly and provisionally.

Matte finish care

If your vehicle has a clear matte finish, observe the following instructions in order to avoid damage to the paintwork due to incorrect care.

These notes also apply to light alloy wheels with a clear matte finish.

- ❗ Never polish the vehicle or the light alloy wheels. Polishing causes the finish to shine.

- ❗ The following may cause the paint to become shiny and thus reduce the matte effect:

- Vigorous rubbing with unsuitable materials.
- Frequent use of car washes.
- Washing the vehicle in direct sunlight.

- ❗ Never use paint cleaner, buffing or polishing products, or gloss preserver, e.g. wax. These products are only suitable for high-gloss surfaces. Their use on vehicles with matte finish leads to considerable surface damage (shiny, spotted areas).

Always have paintwork repairs carried out at a qualified specialist workshop.

- ❗ Do not use wash programs with a hot wax treatment under any circumstances.

- ❗ The vehicle should preferably be washed by hand using a soft sponge, car shampoo and plenty of water.

- ❗ Use only insect remover and car shampoo from the range of recommended and approved Mercedes-Benz care products.

Cleaning the windows

WARNING

You could become trapped by the windshield wipers if they start moving while cleaning the windshield or wiper blades. There is a risk of injury.

Always switch off the windshield wipers and the ignition before cleaning the windshield or wiper blades.

- ❗ Only fold the windshield wipers away from the windshield when vertical. Otherwise, you will damage the hood.

- ❗ Do not use dry cloths, abrasive products, solvents or cleaning agents containing solvents to clean the inside of the windows. Do not touch the insides of the windows with hard objects, e.g. an ice scraper or ring. There is otherwise a risk of damaging the windows.

- ❗ Clean the water drainage channels of the windshield and the rear window at regular intervals. Deposits such as leaves, petals and pollen may under certain circumstances prevent water from draining away. This can lead to corrosion damage and damage to electronic components.

- ▶ Clean the inside and outside of the windows with a damp cloth and a cleaning product that is recommended and approved by Mercedes-Benz.

Cleaning wiper blades

WARNING

You could become trapped by the windshield wipers if they start moving while cleaning the windshield or wiper blades. There is a risk of injury.

Always switch off the windshield wipers and the ignition before cleaning the windshield or wiper blades.

- ❗ Only fold the windshield wipers away from the windshield when vertical. Otherwise, you will damage the hood.
- ❗ Do not pull the wiper blade. Otherwise, the wiper blade could be damaged.
- ❗ Do not clean wiper blades too often and do not rub them too hard. Otherwise, the graphite coating could be damaged. This could cause wiper noise.
- ❗ Hold the wiper arm securely when folding back. The windshield could be damaged if the wiper arm smacks against it suddenly.
- ▶ Fold the windshield wiper arms away from the windshield.
- ▶ Carefully clean the wiper blades with a damp cloth.
- ▶ Fold the windshield wiper arms back again before switching on the ignition.

Cleaning the exterior lighting

- ❗ Only use cleaning agents or cleaning cloths which are suitable for plastic light lenses. Unsuitable cleaning agents or cleaning cloths could scratch or damage the plastic light lenses.
- ▶ Clean the plastic lenses of the exterior lighting using a wet sponge and a mild cleaning agent, e.g. Mercedes-Benz car shampoo. Or clean the exterior lighting with cleaning cloths.

Cleaning the mirror turn signals

- ❗ Only use cleaning agents or cleaning cloths that are suitable for plastic lenses. Unsuitable cleaning agents or cleaning cloths could scratch or damage the plastic lenses of the mirror turn signals.
- ▶ Clean the plastic lenses of the mirror turn signals using a wet sponge and a mild cleaning agent, e.g. Mercedes-Benz car shampoo. Cleaning cloths may be used as well.

Cleaning the sensors

- ❗ If you clean the sensors with a power washer, make sure that you keep a distance of at least 11.8 in (30 cm) between the vehicle and the power washer nozzle. Information about the correct distance is available from the equipment manufacturer.

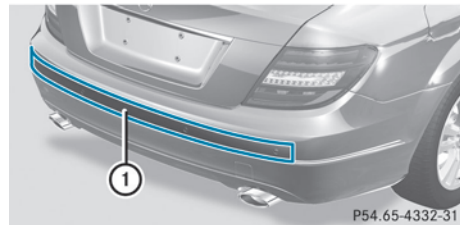
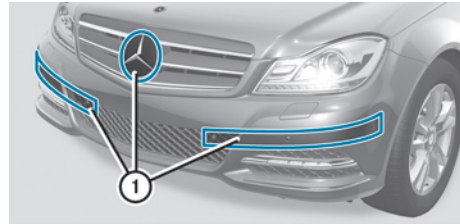

- ▶ Clean sensors ① of the driving systems with water, car shampoo and a soft cloth.

Cleaning the rear view camera

- ❗ Do not clean the camera lens and the area around the rear view camera with a power washer.

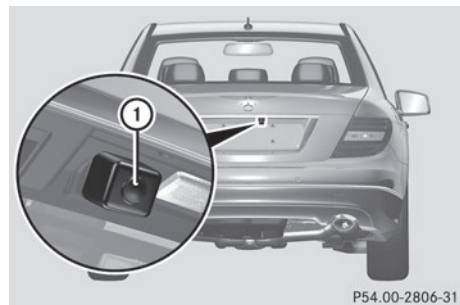

- ▶ Use clear water and a soft cloth to clean camera lens ①.

Cleaning the exhaust pipes

- ❗ Do not clean the exhaust pipe with acid-based cleaning agents such as sanitary cleansers or wheel cleaners.

Impurities combined with the effects of road grit and corrosive environmental factors may cause flash rust to form on the surface. You can restore the original shine of the exhaust tail pipe by cleaning it regularly, especially in winter and after washing.

- ▶ Clean the exhaust tail pipes with a chrome care product tested and approved by Mercedes-Benz.

Interior care

Cleaning the display

- ❗ For cleaning, do not use any of the following:

- alcohol-based thinner or gasoline
- abrasive cleaning agents
- commercially-available household cleaning agents

These may damage the display surface. Do not put pressure on the display surface when cleaning. This could lead to irreparable damage to the display.

- ▶ Before cleaning the display, make sure that it is switched off and has cooled down.
- ▶ Clean the display surface using a commercially available microfiber cloth and TFT/LCD display cleaner.
- ▶ Dry the display surface using a dry microfiber cloth.

Cleaning the plastic trim

WARNING

Care products and cleaning agents containing solvents cause surfaces in the cockpit to become porous. As a result, plastic parts may come loose in the event of air bag deployment. There is a risk of injury.

Do not use any care products and cleaning agents to clean the cockpit.

- ❗ Do not affix the following to plastic surfaces:

- stickers
- films
- scented oil bottles or similar items

You can otherwise damage the plastic.

- ❗ Do not allow cosmetics, insect repellent or sunscreen to come into contact with the plastic trim. This maintains the high-quality look of the surfaces.

- ▶ Wipe the plastic trim with a damp, lint-free cloth, e.g. a microfiber cloth.

- ▶ **Heavy soiling:** use care and cleaning products recommended and approved by Mercedes-Benz. The surface may change color temporarily. Wait until the surface is dry again.

Cleaning the steering wheel and gear or selector lever

- ▶ Thoroughly wipe with a damp cloth or use leather care agents that have been recommended and approved by Mercedes-Benz.

Cleaning genuine wood and trim elements

- ❗ Do not use solvent-based cleaning agents such as tar remover, wheel cleaners, polishes or waxes. There is otherwise a risk of damaging the surface.

- ❗ Do not use chrome polish on trim pieces. The trim pieces have a chrome look but are mostly made of anodized aluminum and can lose their shine if chrome polish is used. Use a damp, lint-free cloth instead when cleaning the trim pieces.

If the chrome-plated trim pieces are very dirty, you can use a chrome polish. If you are unsure as to whether the trim pieces

are chrome-plated or not, consult an authorized Mercedes-Benz Center.

- ▶ Wipe the wooden trim and trim pieces with a damp, lint-free cloth, e.g. a microfiber cloth.
- ▶ **Heavy soiling:** use car care and cleaning products recommended and approved by Mercedes-Benz.

Cleaning the seat covers

General notes

! Do not use microfiber cloths to clean genuine leather, artificial leather or Alcantara® covers. If used often, these can damage the cover.

i Note that regular care is essential to ensure that the appearance and comfort of the covers is retained over time.

Genuine leather seat covers

Leather is a natural product.

It exhibits natural surface characteristics, for example:

- Differences in the texture
- Signs of stretching and marking
- Slight nuances of color

These are characteristics of leather and not material defects.

! To retain the natural appearance of the leather, observe the following cleaning instructions:

- Clean genuine leather covers carefully with a damp cloth and then wipe the covers down with a dry cloth.
- Make sure that the leather does not become soaked. It may otherwise become rough and cracked.
- Only use leather care agents that have been tested and approved by Mercedes-Benz. You can obtain these from a qualified specialist workshop.

Seat covers of other materials

! Observe the following when cleaning:

- Clean artificial leather covers with a cloth moistened with a solution containing 1% detergent (e.g. dish washing liquid).
- Clean cloth covers with a microfiber cloth moistened with a solution containing 1% detergent (e.g. dish washing liquid). Rub carefully and always wipe entire seat sections to avoid leaving visible lines. Leave the seat to dry afterwards. Cleaning results depend on the type of dirt and how long it has been there.
- Clean Alcantara® covers with a damp cloth. Make sure that you wipe entire seat sections to avoid leaving visible lines.

Cleaning the seat belts

WARNING

Seat belts can become severely weakened if bleached or dyed. This could cause the seat belts to tear or fail, for instance, in the event of an accident. This poses an increased risk of injury or fatal injury.

Never bleach or dye the seat belts.

! Do not clean the seat belts using chemical cleaning agents. Do not dry the seat belts by heating at temperatures above 176 °F (80 °C) or in direct sunlight.

- ▶ Use clean, lukewarm water and soap solution.

Cleaning the headliner and carpets

- ▶ **Headliner:** if it is very dirty, use a soft brush or a cleaning agent recommended and approved by Mercedes-Benz.
- ▶ **Carpets:** use the carpet and textile cleaning agents recommended and approved by Mercedes-Benz.

Useful information	300
Where will I find...?	300
Flat tire	301
Battery (vehicle)	302
Jump-starting	306
Towing and tow-starting	308
Fuses	310

Useful information

- i** This Operator's Manual describes all models and all standard and optional equipment of your vehicle available at the time of publication of the Operator's Manual. Country-specific differences are possible. Please note that your vehicle may not be equipped with all features described. This also applies to safety-related systems and functions.
- i** Read the information on qualified specialist workshops: (> page 25).

Where will I find...?

First-aid kit

Depending on the vehicle's equipment, the first-aid kit is located either in an open stowage space or behind the cover on the left side.

- ▶ Open the trunk lid.

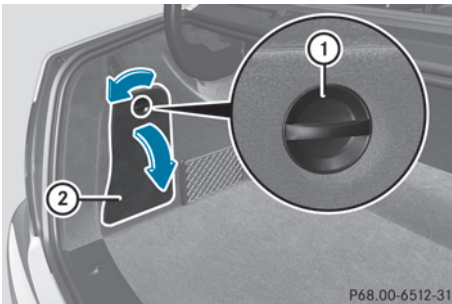

Example: first-aid kit behind the side trim panel

- ▶ **To open the cover:** turn rotary knob ① in the direction of the arrow and fold down cover ②.
- ▶ Remove the first-aid kit.

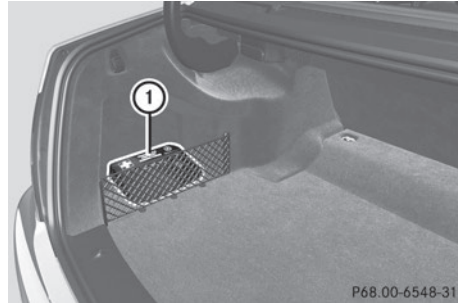

Example: first-aid kit in an open stowage space

- ▶ Remove first-aid kit ①.
- i** Check the expiration date on the first-aid kit at least once a year. Replace the contents if necessary, and replace missing items.

Vehicle tool kit

The vehicle tool kit can be found in the stowage well under the trunk floor.

- ▶ Lift the trunk floor upwards (> page 266).

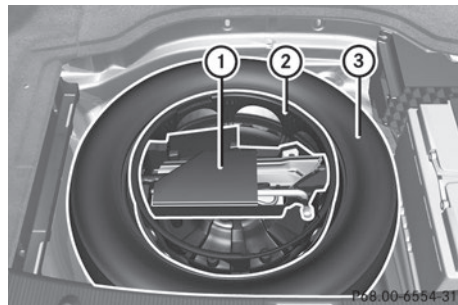

- ① Vehicle tool kit tray
- ② Stowage well
- ③ Spare wheel/"Minispare" emergency spare wheel

The vehicle tool kit contains:

- Folding wheel chock
- Fuse allocation chart
- Jack
- One pair of gloves

- Lug wrench
- Towing eye

Flat tire

Preparing the vehicle

Your vehicle may be equipped with:

- MOExtended tires (tires with run-flat properties) (▷ page 301)
Vehicle preparation is not necessary on vehicles with MOExtended tires.
- a "Minispare" emergency spare wheel
- an emergency spare wheel (only for certain countries) (▷ page 346)

Information on changing/mounting a wheel (▷ page 338).

- ▶ Stop the vehicle on solid, non-slippery and level ground, as far away as possible from traffic.
- ▶ Switch on the hazard warning lamps.
- ▶ Secure the vehicle against rolling away (▷ page 164).
- ▶ If possible, bring the front wheels into the straight-ahead position.
- ▶ Switch off the engine.
- ▶ **Vehicles without KEYLESS-GO:** remove the SmartKey from the ignition lock.
- ▶ **Vehicles with KEYLESS-GO:** open the driver's door.
The on-board electronics have status **0**, which is the same as the SmartKey having been removed.
- ▶ **Vehicles with KEYLESS-GO:** remove the Start/Stop button from the ignition lock (▷ page 148).
- ▶ All occupants must get out of the vehicle. Make sure that they are not endangered as they do so.
- ▶ Make sure that no one is near the danger area while a wheel is being changed. Anyone who is not directly assisting in the wheel change should, for example, stand behind the barrier.

- ▶ Get out of the vehicle. Pay attention to traffic conditions when doing so.
- ▶ Close the driver's door.

MOExtended tires (tires with run-flat properties)

General notes

With MOExtended tires (tires with run flat characteristics), you can continue to drive your vehicle even if there is a total loss of pressure in one or more tires. The affected tire must not show any clearly visible damage. You can recognize MOExtended tires by the MOExtended marking which appears on the sidewall of the tire. You will find this marking next to the tire size designation, the load-bearing capacity and the speed index (▷ page 332).

MOExtended tires may only be used in conjunction with an active tire pressure loss warning system or with an active tire pressure monitor.

If the pressure loss warning message appears in the multifunction display:

- Observe the instructions in the display messages (▷ page 242).
- Check the tire for damage.
- If driving on, observe the following notes.

The maximum driving distance is approximately 50 miles (80 km) when the vehicle is partially laden and approximately 18 miles (30 km) when the vehicle is fully laden.

In addition to the vehicle load, the driving distance possible depends upon:

- Speed
- Road condition
- Outside temperature

The driving distance possible in run-flat mode may be reduced by extreme driving conditions/maneuvers, or it can be increased through a moderate style of driving.

The maximum permissible distance which can be driven in run-flat mode is counted from the moment the tire pressure loss warning appears in the multifunction display.

You must not exceed a maximum speed of 50 mph (80 km/h).

i When replacing one or all tires, make sure that you use only tires:

- of the size specified for the vehicle and
- marked "MOExtended"

If a tire has gone flat and cannot be replaced with a MOExtended tire, a standard tire may be used as a temporary measure. Make sure that you use the proper size and type (summer or winter tire).

Important safety notes

WARNING

When driving in emergency mode, the driving characteristics deteriorate, e.g. when cornering, accelerating quickly and when braking. There is a risk of an accident.

Do not exceed the stated maximum speed. Avoid abrupt steering and driving maneuvers, and driving over obstacles (curbs, potholes, off-road). This applies in particular to a laden vehicle.

Stop driving in emergency mode if:

- you hear banging noises.
- the vehicle starts to shake.
- you see smoke and smell rubber.
- ESP® is intervening constantly.
- there are tears in the sidewalls of the tire.

After driving in emergency mode, have the wheel rims checked at a qualified specialist workshop with regard to their further use. The defective tire must be replaced in every case.

Battery (vehicle)

Important safety notes

Special tools and expert knowledge are required when working on the battery, e.g. removal and installing. You should therefore have all work involving the battery carried out at a qualified specialist workshop.

WARNING

Work carried out incorrectly on the battery can lead, for example, to a short circuit and thus damage the vehicle electronics. This can lead to function restrictions applying to safety-relevant systems, e.g. the lighting system, ABS (anti-lock braking system) or ESP® (Electronic Stability Program). The operating safety of your vehicle may be restricted. You could lose control of the vehicle, for example:

- braking
- in the event of abrupt steering maneuver and/or when the vehicle's speed is not adapted to the road conditions

There is a risk of an accident.

In the event of a short circuit or a similar incident, contact a qualified specialist workshop immediately. Do not drive any further. You should have all work involving the battery carried out at a qualified specialist workshop.

For further information about ABS and ESP®, see (> page 65) and (> page 67).

WARNING

Electrostatic build-up can lead to the creation of sparks, which could ignite the highly explosive gases of a battery. There is a risk of an explosion.

Before handling the battery, touch the vehicle body to remove any existing electrostatic build-up.

The highly flammable gas mixture forms when charging the battery as well as when jump-starting.

Always make sure that neither you nor the battery is electrostatically charged. A build-up of electrostatic charge can be caused, for example:

- by wearing clothing made from synthetic fibers
- due to friction between clothing and seats
- if you push or pull the battery across the carpet or other synthetic materials
- if you wipe the battery with a cloth

WARNING

Battery acid is caustic. There is a risk of injury. Avoid contact with the skin, eyes or clothing. Do not inhale any battery gases. Do not lean over the battery. Keep children away from batteries. Wash battery acid immediately with water and seek medical attention.

WARNING

During the charging process, a battery produces hydrogen gas. If a short circuit occurs or sparks are created, the hydrogen gas can ignite. There is a risk of an explosion.

- Make sure that the positive terminal of a connected battery does not come into contact with vehicle parts.
- Never place metal objects or tools on a battery.
- It is important that you observe the described order of the battery terminals when connecting and disconnecting a battery.
- When jump-starting, make sure that the battery poles with identical polarity are connected.
- It is particularly important to observe the described order when connecting and disconnecting the jumper cables.
- Never connect or disconnect the battery terminals while the engine is running.

WARNING

During charging and jump-starting, explosive gases can escape from the battery. There is a risk of an explosion.

Particularly avoid fire, open flames, creating sparks and smoking. Ensure there is sufficient ventilation while charging and jump-starting. Do not lean over a battery.



Environmental note



Batteries contain dangerous substances. It is against the law to dispose of them with the household rubbish. They must be collected separately and recycled to protect the environment.



Dispose of batteries in an environmentally friendly manner. Take discharged batteries to a qualified specialist workshop or a special collection point for used batteries.

-  Have the battery checked regularly at a qualified specialist workshop. Observe the service intervals in the Maintenance Booklet or contact a qualified specialist workshop for more information.
-  You should have all work involving the battery carried out at a qualified specialist workshop. In the exceptional case that it is necessary for you to disconnect the battery yourself, make sure that:
 - you switch off the engine and remove the SmartKey. On vehicles with KEYLESS-GO, ensure that the ignition is switched off. Check that all the indicator lamps in the instrument cluster are off. Otherwise, electronic components, such as the alternator, may be damaged.
 - you first remove the negative terminal clamp and then the positive terminal clamp. Never swap the terminal clamps.

Otherwise, the vehicle's electronic system may be damaged.

- the transmission is locked in position **P** after disconnecting the battery. The vehicle is secured against rolling away. You can then no longer move the vehicle.

The battery and the cover of the positive terminal clamp must be installed securely during operation.

Comply with safety precautions and take protective measures when handling batteries.



Risk of explosion.



Fire, open flames and smoking are prohibited when handling the battery. Avoid creating sparks.



Battery acid is caustic. Avoid contact with skin, eyes or clothing. Wear suitable protective clothing, especially gloves, apron and faceguard.

Rinse any acid spills immediately with clear water. Contact a physician if necessary.



Wear eye protection.



Keep children away.



Observe this Operator's Manual.

In order for the battery to achieve the maximum possible service life, it must always be sufficiently charged.

Have the battery condition of charge checked more frequently if you use the vehicle mainly for short trips or if you leave it standing idle for a lengthy period. Consult a qualified

specialist workshop if you wish to leave your vehicle parked for a long period of time.

Like other batteries, the vehicle battery may discharge over time if you do not use the vehicle. In this case, have the battery disconnected at a qualified specialist workshop. You can also charge the battery with a charger recommended by Mercedes-Benz. Contact a qualified specialist workshop for further information.

- i** Remove the SmartKey if you park the vehicle and do not require any electrical consumers. The vehicle will then use very little energy, thus conserving battery power.
- i** If the power supply has been interrupted, e.g. if you reconnect the battery, you will have to:
 - set the clock; see the separate operating instructions.
On vehicles with COMAND and a navigation system, the clock is set automatically.
 - reset the function for folding the exterior mirrors in/out automatically by folding the mirrors out once (▷ page 108)¹¹.

Charging the battery

WARNING

During charging and jump-starting, explosive gases can escape from the battery. There is a risk of an explosion.

Particularly avoid fire, open flames, creating sparks and smoking. Ensure there is sufficient ventilation while charging and jump-starting. Do not lean over a battery.

WARNING

Battery acid is caustic. There is a risk of injury. Avoid contact with the skin, eyes or clothing. Do not inhale any battery gases. Do not lean over the battery. Keep children away from

¹¹ This function is only available in vehicles for Canada.

batteries. Wash battery acid immediately with water and seek medical attention.

 **WARNING**

A discharged battery can freeze at temperatures below freezing point. When jump-starting the vehicle or charging the battery, gases can escape from the battery. There is a risk of an explosion.

Allow the frozen battery to thaw out before charging it or jump-starting.

- !** Only charge the installed battery with a battery charger which has been tested and approved by Mercedes-Benz. These battery chargers allow the battery to be charged while still installed in the vehicle.
- !** Only use battery chargers with a maximum charging voltage of 14.8 V.
- !** Only charge the battery using the jump-starting connection point.

The jump-starting connection point is in the engine compartment (▷ page 306).

- ▶ Open the hood.
- ▶ Connect the battery charger to the positive terminal and ground point in the same order as when connecting the donor battery in the jump-starting procedure (▷ page 306).
- ▶ Read the battery charger's operating instructions before charging the battery.

Jump-starting

For the jump-starting procedure, use only the jump-starting connection point, consisting of a positive terminal and a ground point, in the engine compartment.

WARNING

Battery acid is caustic. There is a risk of injury.

Avoid contact with the skin, eyes or clothing. Do not inhale any battery gases. Do not lean over the battery. Keep children away from batteries. Wash battery acid immediately with water and seek medical attention.

WARNING

During charging and jump-starting, explosive gases can escape from the battery. There is a risk of an explosion.

Particularly avoid fire, open flames, creating sparks and smoking. Ensure there is sufficient ventilation while charging and jump-starting. Do not lean over a battery.

WARNING

During the charging process, a battery produces hydrogen gas. If a short circuit occurs or sparks are created, the hydrogen gas can ignite. There is a risk of an explosion.

- Make sure that the positive terminal of a connected battery does not come into contact with vehicle parts.
- Never place metal objects or tools on a battery.
- It is important that you observe the described order of the battery terminals when connecting and disconnecting a battery.
- When jump-starting, make sure that the battery poles with identical polarity are connected.
- It is particularly important to observe the described order when connecting and disconnecting the jumper cables.
- Never connect or disconnect the battery terminals while the engine is running.

WARNING

Non-combusted fuel can collect in the exhaust system and ignite. There is a risk of fire. Avoid repeated and lengthy starting attempts.

! Avoid repeated and lengthy starting attempts. Otherwise, the catalytic converter could be damaged by the non-combusted fuel.

Do not start the vehicle using a rapid charging device. If your vehicle's battery is discharged, the engine can be jump-started from another vehicle or from a second battery using jumper cables. Observe the following points:

- The battery is not accessible in all vehicles. If the other vehicle's battery is not accessible, jump-start the vehicle using a second battery or a jump-starting device.
- You may only jump-start the vehicle when the engine and exhaust system are cold.
- Do not start the engine if the battery is frozen. Let the battery thaw first.
- Jump-starting may only be performed from batteries with a nominal voltage of 12 V.

- Only use jumper cables which have a sufficient cross-section and insulated terminal clamps.
- If the battery is fully discharged, leave the battery that is being used to jump-start connected for a few minutes before attempting to start. This charges the battery slightly.
- Make sure that the two vehicles do not touch.

Make sure that:

- the jumper cables are not damaged.
 - bare parts of the terminal clamp do not come into contact with other metal parts while the jumper cables are connected to the battery.
 - the jumper cables cannot come into contact with parts such as the V-belt pulley or the fan. These parts move when the engine is started and while it is running.
- ▶ Apply the parking brake firmly.
- ▶ Move the selector lever to position **P**.
- ▶ Switch off all electrical consumers, e.g. rear window defroster, lighting, etc.
- ▶ Open the hood.

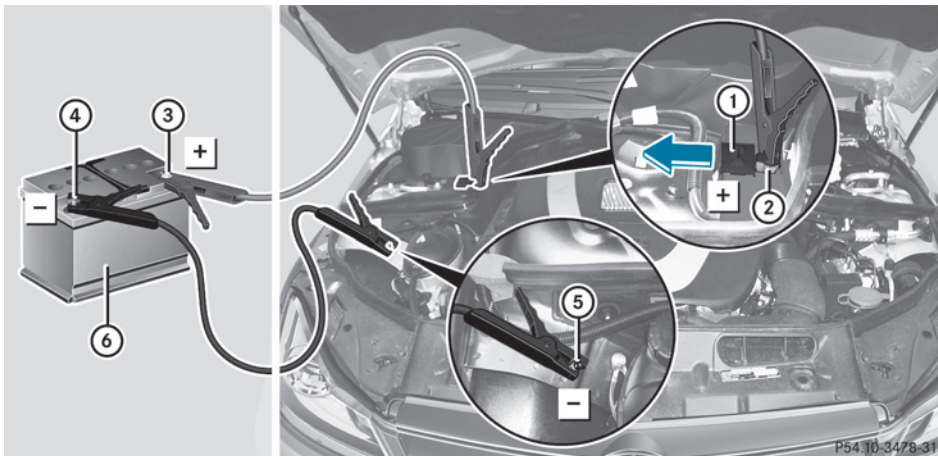

Position number ⑥ identifies the charged battery of the other vehicle or an equivalent jump-starting device.

- ▶ Slide cover ① of positive terminal ② in the direction of the arrow.
- ▶ Connect positive terminal ② on your vehicle to positive terminal ③ of donor battery ⑥ using the jumper cable, beginning with your own battery.
- ▶ Start the engine of the donor vehicle and run it at idling speed.
- ▶ Connect negative terminal ④ of donor battery ⑥ to ground point ⑤ of your vehicle using the jumper cable, connecting the jumper cable to battery of other vehicle ⑥ first.
- ▶ Start the engine.
- ▶ Before disconnecting the jumper cables, let the engine run for several minutes.
- ▶ First, remove the jumper cables from ground point ⑤ and negative terminal ④, then from positive clamp ② and positive terminal ③. Begin each time at the contacts on your own vehicle first.

- ▶ Close cover ① of positive terminal ② after removing the jumper cables.
- ▶ Have the battery checked at a qualified specialist workshop.
- i** Jump-starting is not considered to be a normal operating condition.
- i** Jumper cables and further information regarding jump-starting can be obtained at any qualified specialist workshop.

Towing and tow-starting

Important safety notes

⚠ WARNING

You can no longer steer the vehicle if the steering wheel lock has been engaged. There is a risk of an accident.

Always switch off the ignition when towing the vehicle with a tow cable or a tow bar.

⚠ WARNING

If the weight of the vehicle to be towed or tow-started is greater than the permissible gross weight of your vehicle:

- the towing eye could detach itself
- the vehicle/trailer combination could rollover.

There is a risk of an accident.

When towing or tow-starting another vehicle, its weight should not be greater than the permissible gross weight of your vehicle.

Information on your vehicle's gross vehicle weight rating can be found on the vehicle identification plate (▷ page 350).

- !** If DISTRONIC PLUS or the HOLD function is activated, the vehicle brakes automatically in certain situations. To prevent damage to the vehicle, deactivate DISTRONIC PLUS and the HOLD function in the following or other similar situations:
 - when towing the vehicle
 - in the car wash
- !** The vehicle can be towed a maximum of 30 miles (50km). The towing speed of 30 mph (50 km/h) must not be exceeded.

If the vehicle has to be towed more than 30 miles (50km), the entire vehicle must be raised and transported.

- !** Only secure the tow rope or tow bar at the towing eyes. Otherwise, the vehicle could be damaged.
- !** Do not use the towing eyes for recovery purposes as this could damage the vehicle. If in doubt, recover the vehicle with a crane.
- !** When towing, pull away slowly and smoothly. If the tractive power is too high, the vehicles could be damaged.
- !** Do not tow with sling-type equipment. This could damage the vehicle.
- !** On vehicles with KEYLESS-GO, use the SmartKey instead of the Start/Stop button. Turn the SmartKey to position **2** in the ignition lock and shift the automatic transmission to **N**. Then, turn the SmartKey back to **0** and leave it in the ignition lock.

It is better to have the vehicle transported than to have it towed.

The automatic transmission must be in position **N** when the vehicle is being towed.

The battery must be connected and charged. Otherwise, you:

- cannot turn the SmartKey to position **2** in the ignition lock
- cannot shift the automatic transmission to position **N**

Release the selector lever lock manually to move it out of position **P**(▷ page 161).

- i** Deactivate the automatic locking feature (▷ page 83). You could otherwise be locked out when pushing or towing the vehicle.

Installing/removing the towing eye

Installing the towing eye

WARNING

The exhaust tail pipe may be very hot. There is a risk of burns when removing the rear cover.

Do not touch the exhaust pipe. Take particular care when removing the rear cover.

- ▶ Remove the towing eye from the vehicle tool kit (▷ page 300).

The mountings for the removable towing eyes are located in the bumpers. They are at the front and at the rear, behind the covers.



- ▶ Press the mark on cover ① inwards in the direction of the arrow.
- ▶ Take cover ① off the opening.
- ▶ Screw in and tighten the towing eye clockwise to the stop.

Removing the towing eye

- ▶ Unscrew and remove the towing eye.
- ▶ Attach cover ① to the bumper and press until it engages.
- ▶ Place the towing eye in the vehicle tool kit.

Towing the vehicle with the rear axle raised

Only possible for vehicles without 4MATIC.

When towing your vehicle with the rear axle raised, it is important that you observe the safety instructions (▷ page 308).

- ❗ The ignition must be switched off if you are towing the vehicle with the rear axle raised. Intervention by ESP® could otherwise damage the brake system.
- ▶ Switch on the hazard warning lamps (▷ page 117).
- ▶ Turn the SmartKey to position **0** in the ignition lock and remove the SmartKey from the ignition lock.
- ▶ When leaving the vehicle, take the SmartKey or the KEYLESS-GO key with you.

Towing a vehicle with both axles on the ground

It is important that you observe the safety instructions when towing away your vehicle (▷ page 308).

- ▶ Switch on the hazard warning lamps (▷ page 117).
- i** When towing with the hazard warning lamps switched on, use the combination switch as usual to signal a change of direction. In this case, only the indicator lamps for the direction of travel flash. After resetting the combination switch, the hazard warning lamp starts flashing again.
- ▶ Turn the SmartKey to position **2** in the ignition lock.
- ▶ When the vehicle is stationary, depress the brake pedal and keep it depressed.
- ▶ Shift the automatic transmission to position **N**.
- ▶ Release the brake pedal.
- ▶ Release the parking brake.

Transporting the vehicle

The towing eye can be used to pull the vehicle onto a trailer or transporter for transporting purposes.

- ▶ Turn the SmartKey to position **2** in the ignition lock.
- ▶ Move the selector lever to **N**.

As soon as the vehicle has been loaded:

- ▶ Prevent the vehicle from rolling away by applying the parking brake.
- ▶ Move the selector lever to position **P**.
- ▶ Turn the SmartKey to position **0** in the ignition lock and remove the SmartKey from the ignition lock.
- ▶ Secure the vehicle.

❗ You may only secure the vehicle by the wheels, not by parts of the vehicle such as axle or steering components. Otherwise, the vehicle could be damaged.

Notes on 4MATIC vehicles

❗ Vehicles with 4MATIC must not be towed with either the front or the rear axle raised, as doing so will damage the transmission.

If the vehicle has transmission damage or damage to the front or rear axle, have it transported on a transporter or trailer.

In the event of damage to the electrical system

If the battery is defective, the automatic transmission will be locked in position **P**. To shift the automatic transmission to position **N**, you must provide power to the vehicle's electrical system in the same way as when jump-starting (▷ page 306).

Have the vehicle transported on a transporter or trailer.

Tow-starting (emergency engine starting)

❗ Vehicles with automatic transmission must not be started by tow-starting. This could otherwise damage the transmission.

You can find information on "Jump-starting" at (▷ page 306).

Fuses

Important safety notes

⚠ WARNING

If you manipulate or bridge a faulty fuse or if you replace it with a fuse with a higher amperage, the electric cables could be overloaded. This could result in a fire. There is a risk of an accident and injury.

Always replace faulty fuses with the specified new fuses having the correct amperage.

❗ Only use fuses that have been approved for Mercedes-Benz vehicles and which have the correct fuse rating for the system concerned. Otherwise, components or systems could be damaged.

The fuses in your vehicle serve to close down faulty circuits. If a fuse blows, all the components on the circuit and their functions stop operating.

Blown fuses must be replaced with fuses of the same rating, which you can recognize by the color and value. The fuse ratings are listed in the fuse allocation chart.

If a newly inserted fuse also blows, have the cause traced and rectified at a qualified specialist workshop, e.g. an authorized Mercedes-Benz Center.

Before changing a fuse

- ▶ Secure the vehicle against rolling away (▷ page 164).
- ▶ Switch off all electrical consumers.

▶ Turn the SmartKey to position **0** in the ignition lock and remove it (▷ page 147).

or

▶ On vehicles with KEYLESS-GO, make sure the ignition is switched off (▷ page 148).

All indicator lamps in the instrument cluster must be off.

The fuses are located in various fuse boxes:

- Fuse box on the driver's side of the dashboard
- Fuse box in the engine compartment on the left-hand side of the vehicle, when viewed in the direction of travel
- Fuse box in the trunk on the right-hand side of the vehicle, when viewed in the direction of travel

The fuse allocation chart is located in the vehicle tool kit in the stowage compartment under the trunk floor (▷ page 300).

Dashboard fuse box

- ❗ Do not use a pointed object such as a screwdriver to open the cover in the dashboard. You could damage the dashboard or the cover.
- ❗ Make sure that no moisture can enter the fuse box when the cover is open.
- ❗ When closing the cover, make sure that it is lying correctly on the fuse box. Moisture seeping in or dirt could otherwise impair the operation of the fuses.

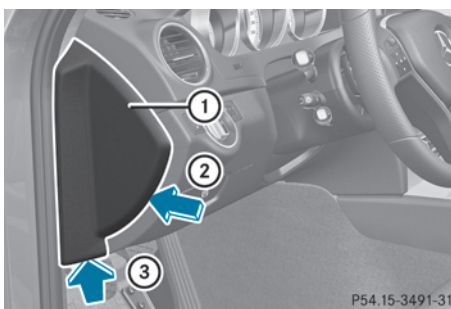

▶ **To open:** pull out cover ① slightly at the bottom in the direction of arrow ③.

▶ Pull cover ① outwards in the direction of arrow ② and remove it.

▶ **To close:** clip in cover ① on the front of the dashboard.

▶ Fold cover ① inwards until it engages.

Fuse box in the engine compartment

⚠ WARNING

When the hood is open and the windshield wipers are set in motion, you can be injured by the wiper linkage. There is a risk of injury. Always switch off the windshield wipers and the ignition before opening the hood.

❗ Make sure that no moisture can enter the fuse box when the cover is open.

❗ When closing the cover, make sure that it is lying correctly on the fuse box. Moisture seeping in or dirt could otherwise impair the operation of the fuses.

▶ Make sure that the windshield wipers are turned off.

▶ Open the hood.

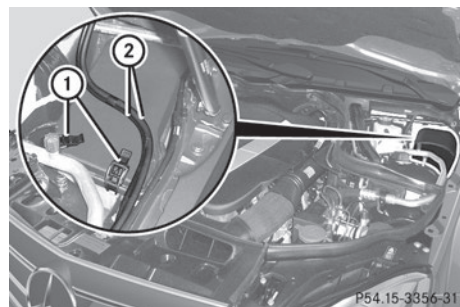

▶ Use a dry cloth to remove any moisture from the fuse box.

▶ **To open:** take lines ② from the guides.

▶ Open clamps ①.

▶ Remove the fuse box cover forwards.

- ▶ **To close:** check whether the rubber seal is lying correctly in the cover.
- ▶ Insert the cover at the rear of the fuse box into the retainer.
- ▶ Fold down cover and close clamps ①.
- ▶ Secure lines ② in the guides.
- ▶ Close the hood.

Fuse box in the trunk

- ❗ Make sure that no moisture can enter the fuse box when the cover is open.
- ❗ When closing the cover, make sure that it is lying correctly on the fuse box. Moisture seeping in or dirt could otherwise impair the operation of the fuses.
- ▶ Open the trunk lid.

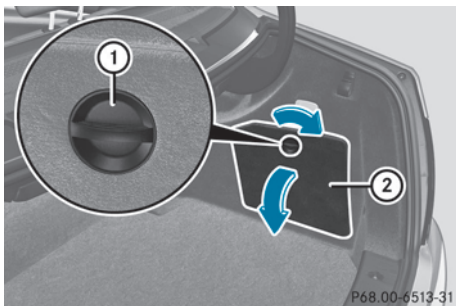

- ▶ **To open:** turn rotary catch ① clockwise.
- ▶ Open cover ② downwards in the direction of the arrow.

Useful information	314
Important safety notes	314
Operation	314
Winter operation	316
Tire pressure	318
Loading the vehicle	326
Maximum load rating	329
Uniform Tire Quality Grading Standards	330
Tire labeling	331
Definition of terms for tires and loading	335
Changing a wheel	338
Mounting a wheel	338
Wheel and tire combinations	342
Emergency spare wheel	346

Useful information

- i** This Operator's Manual describes all models and all standard and optional equipment of your vehicle available at the time of publication of the Operator's Manual. Country-specific differences are possible. Please note that your vehicle may not be equipped with all features described. This also applies to safety-related systems and functions.
- i** Read the information on qualified specialist workshops: (> page 25).

Important safety notes

WARNING

If wheels and tires of the wrong size are used, the wheel brakes or suspension components may be damaged. There is a risk of an accident.

Always replace wheels and tires with those that fulfill the specifications of the original part.

When replacing wheels, make sure to use the correct:

- designation
- model

When replacing tires, make sure to use the correct:

- designation
- manufacturer
- model

WARNING

A flat tire severely impairs the driving, steering and braking characteristics of the vehicle. There is a risk of accident.

Tires without run-flat characteristics:

- do not drive with a flat tire.
- immediately replace the flat tire with your emergency spare wheel or spare wheel, or consult a qualified specialist workshop.

Tires with run-flat characteristics:

- pay attention to the information and warning notices on MOExtended tires (tires with run-flat characteristics).

Accessories that are not approved for your vehicle by Mercedes-Benz or that are not being used correctly can impair operating safety.

Before purchasing and using non-approved accessories, visit a qualified specialist workshop and inquire about:

- suitability
- legal stipulations
- factory recommendations

Information on the dimensions and types of wheels and tires for your vehicle can be found in the "Wheel/tire combinations" section (> page 342).

Information on air pressure for the tires on your vehicle can be found:

- on the vehicle's Tire and Loading Information placard on the B-pillar
- on the tire pressure label on the fuel filler flap
- in the "Tire pressure" section

Modification work on the brake system and wheels is not permitted. The use of wheel spacers or brake dust shields is not permitted. This invalidates the general operating permit for the vehicle.

- i** Further information on wheels and tires can be obtained at any qualified specialist workshop.

Operation

Information on driving

- If the vehicle is heavily loaded, check the tire pressures and correct them if necessary.
- While driving, pay attention to vibrations, noises and unusual handling

characteristics, e.g. pulling to one side. This may indicate that the wheels or tires are damaged. If you suspect that a tire is defective, reduce your speed immediately. Stop the vehicle as soon as possible to check the wheels and tires for damage. Hidden tire damage could also be causing the unusual handling characteristics. If you find no signs of damage, have the tires and wheels checked at a qualified specialist workshop.

- When parking your vehicle, make sure that the tires do not get deformed by the curb or other obstacles. If it is necessary to drive over curbs, speed humps or similar elevations, try to do so slowly and at an obtuse angle. Otherwise, the tires, particularly the sidewalls, may be damaged.

Regular checking of wheels and tires

WARNING

Damaged tires can cause tire inflation pressure loss. As a result, you could lose control of your vehicle. There is a risk of accident.

Check the tires regularly for signs of damage and replace any damaged tires immediately.

- Regularly check the wheels and tires of your vehicle for damage at least once a month, as well as after driving off-road or on rough roads. Damaged wheels can cause a loss of tire pressure. Pay particular attention to damage such as:
 - cuts in the tires
 - punctures
 - tears in the tires
 - bulges on tires
 - deformation or severe corrosion on wheels
- Regularly check the tire tread depth and the condition of the tread across the whole width of the tire (▷ page 315). If necessary,

turn the front wheels to full lock in order to inspect the inner side of the tire surface.

- All wheels must have a valve cap to protect the valve against dirt and moisture. Do not mount anything onto the valve other than the standard valve cap or other valve caps approved by Mercedes-Benz for your vehicle. Do not use any other valve caps or systems, e.g. tire pressure monitoring systems.
- Regularly check the pressure of all the tires including the emergency spare wheel or the spare wheel, particularly prior to long trips, and correct the pressure as necessary (▷ page 318).

Observe the notes on the emergency spare wheel (▷ page 346).

The service life of tires depends, among other things, on the following factors:

- Driving style
- Tire pressure
- Distance covered

Important safety notes on the tire tread

WARNING

Insufficient tire tread will reduce tire traction. The tire is no longer able to dissipate water. This means that on wet road surfaces, the risk of hydroplaning increases, in particular where speed is not adapted to suit the driving conditions. There is a risk of accident.

If the tire pressure is too high or too low, tires may exhibit different levels of wear at different locations on the tire tread. Thus, you should regularly check the tread depth and the condition of the tread across the entire width of all tires.

Minimum tire tread depth for:

- Summer tires: $\frac{1}{8}$ in (3 mm)
- M+S tires: $\frac{1}{8}$ in (4 mm)

For safety reasons, replace the tires before the legally prescribed limit for the minimum tire tread depth is reached.

Treadwear indicators (TWI) are required by law. Six indicators are positioned on the tire tread. They are visible once the tread depth is approximately $\frac{1}{16}$ in (1.6 mm). If this is the case, the tire is so worn that it must be replaced.

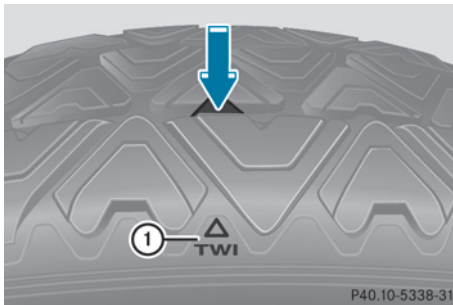

Bar indicator ① for tread wear is integrated into the tire tread.

Selecting, mounting and replacing tires

- Only mount tires and wheels of the same type and make.
Exception: it is permissible to install a different type or make in the event of a flat tire. Observe the "MOExtended tires (tires with run-flat characteristics)" section (▷ page 301).
- Only mount tires of the correct size onto the wheels.
- After mounting new tires, break them in at moderate speeds for the first 60 miles (100 km), as they only reach their full performance after this distance.
- Do not drive with tires which have too little tread depth, as this significantly reduces the traction on wet roads (hydroplaning).
- Replace the tires after six years at the latest, regardless of wear.

Observe the notes on the emergency spare wheel (▷ page 346).

MOExtended tires (tires with run-flat properties)

With MOExtended tires (tires with run flat characteristics), you can continue to drive your vehicle even if there is a total loss of pressure in one or more tires.

MOExtended tires may only be used in conjunction with an active tire pressure loss warning system or with an active tire pressure monitor and on wheels specifically tested by Mercedes-Benz.

Notes on driving with MOExtended tires in the event of a flat tire can be found in the "Breakdown assistance" section (▷ page 301).

Winter operation

Points to remember

Have your vehicle winterproofed at a qualified specialist workshop at the onset of winter. Observe the notes in the "Changing a wheel" section (▷ page 338).

Driving with summer tires

At temperatures below 45 °F (+7 °C), summer tires lose elasticity and therefore traction and braking power. Change the tires on your vehicle to M+S tires. Using summer tires at very cold temperatures could cause cracks to form, thereby damaging the tires permanently. Mercedes-Benz cannot accept responsibility for this type of damage.

M+S tires

WARNING

M+S tires with a tire tread depth of less than $\frac{1}{8}$ in (4 mm) are not suitable for use in winter

and do not provide sufficient traction. There is a risk of an accident.

M+S tires with a tread depth of less than $\frac{1}{8}$ in (4 mm) must be replaced immediately.

At temperatures below 45 °F (+7 °C), use winter tires or all-season tires. Both types of tire are identified by the M+S marking.

Only winter tires bearing the  snowflake symbol in addition to the M+S marking provide the best possible grip in wintry road conditions. Only these tires will allow driving safety systems such as ABS and ESP® to function optimally in winter. These tires have been developed specifically for driving in snow.

Use M+S tires of the same make and tread on all wheels to maintain safe handling characteristics.

Always observe the maximum permissible speed specified for the M+S tires you have mounted.

When you have mounted M+S tires:

- ▶ Check the tire pressures (▷ page 321).
- ▶ **Vehicles for Canada:** restart the tire pressure loss warning system (▷ page 321).
- ▶ **Vehicles for USA:** restart the tire pressure monitor (▷ page 322).

For more information on driving with the emergency spare wheel, see (▷ page 346).

Snow chains

WARNING

If snow chains are installed to the front wheels, they may drag against the vehicle body or chassis components. This could cause damage to the vehicle or the tires. There is a risk of an accident.

To avoid hazardous situations:

- never install snow chains to the front wheels
- always install snow chains in pairs to the rear wheels.

! On some tire sizes there is not enough space for snow chains. To avoid damage to the vehicle or tires, observe the "Wheel and tire combinations" section under "Tires and wheels".

! **Vehicles with steel wheels:** if you wish to mount snow chains on steel wheels, make sure that you remove the respective wheels' hubcaps first. The hubcaps may otherwise be damaged.

For safety reasons, Mercedes-Benz recommends that you only use snow chains that have been specially approved for your vehicle by Mercedes-Benz, or are of a corresponding standard of quality.

If you intend to mount snow chains, please bear the following points in mind:

- snow chains may not be mounted on all wheel/tire combinations. Permissible wheel-tire combinations (▷ page 342).
- only use snow chains when driving on roads completely covered by snow. Remove the snow chains as soon as possible when you come to a road that is not snow-covered.
- local regulations may restrict the use of snow chains. Observe the appropriate regulations if you wish to mount snow chains.
- do not exceed the maximum permissible speed of 30 mph (50 km/h).
- i** You may wish to deactivate ESP® (▷ page 68) when pulling away with snow chains installed. You can thereby allow the wheels to spin in a controlled manner, achieving an increased driving force (cutting action).

For more information on driving with the emergency spare wheel, see (▷ page 346).

Tire pressure

Tire pressure specifications

WARNING

Underinflated or overinflated tires pose the following risks:

- the tires may burst, especially as the load and vehicle speed increase.
- the tires may wear excessively and/or unevenly, which may greatly impair tire traction.
- the driving characteristics, as well as steering and braking, may be greatly impaired.

There is a risk of an accident.

Follow recommended tire inflation pressures and check the pressure of all the tires including the spare wheel:

- monthly, at least
- if the load changes
- before beginning a long journey
- under different operating conditions, e.g. off-road driving

If necessary, correct the tire pressure.

The recommended tire pressures for the tires mounted at the factory can be found on the labels described here.

1.) **Tire and Loading Information placard** on the B-pillar on the driver's side of the vehicle (▷ page 326).

The Tire and Loading Information placard contains the recommended tire pressures for cold tires on a fully loaded vehicle and for the maximum permissible vehicle speed.

-  The specifications given on the following Tire and Loading Information placard are examples. Tire pressure specifications are vehicle-specific and may deviate from the data shown here. The tire pressures applicable to your vehicle can be found on the Tire and Loading Information placard on your vehicle.

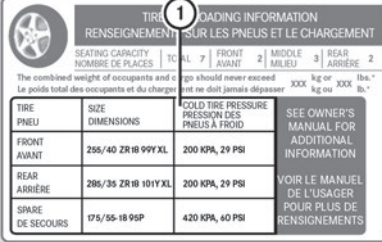

TIRE AND LOADING INFORMATION
RENSEIGNEMENTS SUR LES PNEUS ET LE CHARGEMENT

SEATING CAPACITY / NOMBRE DE PLACES: TOTAL 7 | FRONT / AVANT 2 | MIDDLE / MILIEU 3 | REAR / ARRIERE 2

The combined weight of occupants and cargo should never exceed XXX kg or XXX lbs. Le poids total des occupants et du chargement ne doit jamais dépasser XXX kg ou XXX lbs.

TIRE / PNEU	SIZE / DIMENSIONS	COLD TIRE PRESSURE / PRESSION DES PNEUS A FROID	SEE OWNER'S MANUAL FOR ADDITIONAL INFORMATION / VOIR LE MANUEL DE L'USAGER POUR PLUS DE RENSEIGNEMENTS
FRONT / AVANT	255/40 ZR18 99YXL	200 KPA, 29 PSI	
REAR / ARRIERE	285/35 ZR18 101YXL	200 KPA, 29 PSI	
SPARE / DE SECOURS	175/55-18 95P	420 KPA, 60 PSI	

P40.00-2205-31

① Recommended tire pressures

Option 2) **Tire pressure table** on the inside of the fuel filler flap.

The tire pressure table contains the recommended pressures for cold tires for various operating conditions, i.e. differing load and speed conditions.

-  Specifications shown in the examples of tire pressure tables are for illustration purposes only. Tire pressure specifications are vehicle-specific and may deviate from the data shown here. Tire pressure specifications applicable to your vehicle are located in your vehicle's tire pressure table.

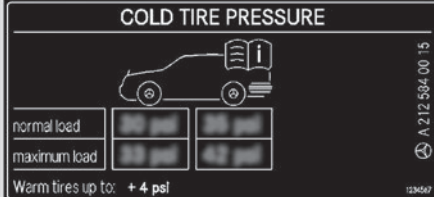

COLD TIRE PRESSURE

normal load	250 psi	250 psi
maximum load	350 psi	420 psi

Warm tires up to: + 4 psi

A 212 594 00 15

1234567

P40.00-2179-31

Example: tire pressure table for all tires permitted for this vehicle by the factory

If a tire size precedes a tire pressure, the tire pressure information following is only valid for that tire size. The load conditions "partially laden" and "fully laden" are defined in the table for different numbers of occupants and amounts of luggage. The actual number of seats may differ.

LUFTDRUCK PRESSURE PRESSION PRESIÓN			
für kalte Reifen		for cold tires	
195/55 R16	2.3 bar	33 psi	
215/45 R17	2.5 bar	36 psi	
215/40 R18	2.5 bar	36 psi	
Warme Reifen bis: Warm tires up to:		+ 30 kPa + 4 psi	
Preus échauffes jusqu'à: Neumáticos calientes hasta:		+ 30 kPa + 4 psi	

100 kPa = 1 bar

P40.00-2183-31

Example: tire pressure table with tire dimensions

Some tire pressure tables show only the rim diameters instead of the full tire size, e.g.

R18. The rim diameter is part of the tire size and can be found on the tire sidewall (▷ page 332).

Luftdruck für kalte Reifen			
Tire pressure cold tires		Pression des pneus froids	
R18	2.3 bar	33 psi	
R19	2.5 bar	36 psi	
bis up to 240 km/h / jusqu'à 150 mph		Wintererle: Winter tires: Neumáticos de invierno:	
Warme Reifen bis: Warm tires up to:		+ 30 kPa + 4 psi	
Preus échauffes jusqu'à: Neumáticos calientes hasta:		+ 30 kPa + 4 psi	

100 kPa = 1 bar

P40.00-2184-31

If the tire pressures have been set to the lower values for lighter loads and/or lower road speeds, the pressures should be reset to the higher values:

- if you want to drive with an increased load and/or
 - if you want to drive at higher road speeds.
- i** The tire pressures for increased loads and/or higher road speeds, shown in the tire pressure table, may have a negative effect on driving comfort.

Option 3) The **tire pressure for the emergency/collapsible spare wheel** (depending on vehicle equipment) can be found:

- printed in yellow on the rim of the emergency/collapsible spare wheel
- in the "Wheel and tire combinations" section (▷ page 342) in this Operator's Manual
- on the Tire and Loading Information placard on the B-pillar on the driver's side

If the tire pressure is not set correctly, this can lead to an excessive build up of heat and a sudden loss of pressure.

For more information, contact a qualified specialist workshop.

Important notes on tire pressure

⚠ WARNING

If the tire pressure drops repeatedly, the wheel, valve or tire may be damaged. Tire pressure that is too low may result in a tire blow-out. There is a risk of an accident.

- Check the tire for foreign objects.
- Check whether the wheel is losing air or the valve is leaking.

If you are unable to rectify the damage, contact a qualified specialist workshop.

⚠ WARNING

If you fit unsuitable accessories onto tire valves, the tire valves may be overloaded and malfunction, which can cause tire pressure loss. Due to their design, retrofitted tire pressure monitors keep the tire valve open. This can also result in tire pressure loss. There is a risk of an accident.

Only screw the standard valve cap or other valve caps approved by Mercedes-Benz for your vehicle onto the tire valve.

To test tire pressure, use a suitable tire pressure gauge. The outer appearance of a tire does not permit any reliable conclusion

about the tire pressure. On vehicles equipped with the electronic tire pressure monitoring system, the tire pressure can be checked using the on-board computer.

The tire temperature and pressure increase when the vehicle is in motion. This is dependent on the driving speed and the load. Therefore, you should only correct tire pressures when the tires are cold.

The tires are cold:

- if the vehicle has been parked without direct sunlight on the tires for at least three hours and
- if the vehicle has not been driven further than 1 mile (1.6 km)

The tire temperature changes depending on the outside temperature, the vehicle speed and the tire load. If the tire temperature changes by 18 °F (10 °C), the tire pressure changes by approximately 10 kPa (0.1 bar/ 1.5 psi). Take this into account when checking the pressure of warm tires and only correct the tire pressure if it is too low for the current operating conditions. If you check the tire pressure when the tires are warm, the resulting value will be higher than if the tires were cold. This is normal. Do not reduce the tire pressure to the value specified for cold tires. The tire pressure would otherwise be too low.

Observe the recommended tire pressures for cold tires:

- on the Tire and Loading Information placard on the B-pillar on the driver's side
- in the tire pressure table on the inside of the fuel filler flap
- printed in yellow on the rim of the emergency/collapsible spare wheel (depending on vehicle equipment)

Underinflated or overinflated tires

Underinflation

WARNING

Tires with pressure that is too low can overheat and burst as a consequence. In addition, they also suffer from excessive and/ or irregular wear, which can severely impair the braking properties and the driving characteristics. There is a risk of an accident.

Avoid tire pressures that are too low in all the tires, including the spare wheel.

Underinflated tires may:

- wear quickly and unevenly
- have an adverse effect on fuel consumption
- overheat, leading to tire defects
- have an adverse effect on handling characteristics

Overinflation

WARNING

Tires with excessively high pressure can burst because they are damaged more easily by road debris, potholes etc. In addition, they also suffer from irregular wear, which can severely impair the braking properties and the driving characteristics. There is a risk of an accident.

Avoid tire pressures that are too high in all the tires, including the spare wheel.

Overinflated tires may:

- have an adverse effect on handling characteristics
- wear quickly and unevenly
- be more susceptible to damage
- have an adverse effect on ride comfort
- increase the braking distance

Maximum tire pressures

Never exceed the maximum permissible tire inflation pressure. Always observe the

recommended tire pressure for your vehicle when adjusting the tire pressure (▷ page 318).

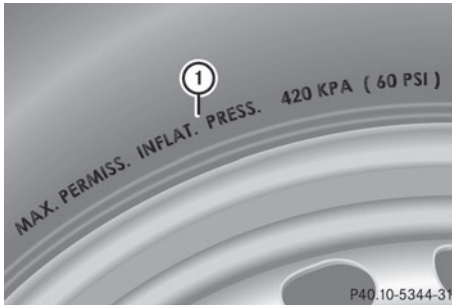

- ① Example: maximum permissible tire pressure
- ❗ The actual values for tires are vehicle-specific and may deviate from the values in the illustration.

Checking the tire pressures

Important safety notes

Observe the "tire pressure information" section (▷ page 318).

Information on air pressure for the tires on your vehicle can be found:

- on the vehicle's Tire and Loading Information placard on the B-pillar
- on the tire pressure label on the fuel filler flap
- in the "Tire pressure information" section

Checking tire pressures manually

To determine and set the correct tire pressure, proceed as follows:

- ▶ Remove the valve cap of the tire that is to be checked.
- ▶ Press the tire pressure gauge securely onto the valve.
- ▶ Read the tire pressure and compare it with the recommended value on the Tire and Loading Information placard on the B-pillar on the driver's side of your vehicle.

- ▶ If necessary, increase the tire pressure to the recommended value (▷ page 318).
- ▶ If the tire pressure is too high, release air by pressing down the metal pin in the valve using the tip of a pen, for example. Then, check the tire pressure again using the tire pressure gauge.
- ▶ Screw the valve cap onto the valve.
- ▶ Repeat these steps for the other tires.

Tire pressure loss warning system (Canada only)

General notes

While the vehicle is in motion, the tire pressure loss warning system monitors the set tire pressure using the rotational speed of the wheels. This enables the system to detect significant pressure loss in a tire. If the speed of rotation of a wheel changes as a result of a loss of pressure, a corresponding warning message will appear in the multifunction display.

You can recognize the tire pressure loss warning by the **Run Flat Indicator Active Press 'OK' to Restart** message which appears in the **Service** menu of the multifunction display. Information on the message display can be found in the "Restarting the tire pressure loss warning system" section (▷ page 322).

Important safety notes

The tire pressure warning system does not warn you of an incorrectly set tire pressure. Observe the notes on the recommended tire pressure (▷ page 318).

The tire pressure loss warning does not replace the need to regularly check the tire pressure. An even loss of pressure on several tires at the same time cannot be detected by the tire pressure loss warning system.

The tire pressure monitor is not able to warn you of a sudden loss of pressure, e.g. if the tire is penetrated by a foreign object. In the

event of a sudden loss of pressure, bring the vehicle to a halt by braking carefully. Avoid abrupt steering maneuvers.

The function of the tire pressure loss warning system is limited or delayed if:



- snow chains are mounted on your vehicle's tires.
- road conditions are wintry.
- you are driving on sand or gravel.
- you adopt a very sporty driving style (cornering at high speeds or driving with high rates of acceleration).
- you are driving with a heavy load (in the vehicle or on the roof).



Restarting the tire pressure loss warning system

Restart the tire pressure loss warning system if you have:

- changed the tire pressure
- changed the wheels or tires
- mounted new wheels or tires
- ▶ Before restarting, make sure that the tire pressures are set properly on all four tires for the respective operating conditions.

The recommended tire pressure can be found on the Tire and Loading Information placard on the B-pillar on the driver's side. A tire pressure table is also affixed to the fuel filler flap. The tire pressure loss warning system can only give reliable warnings if you have set the correct tire pressure. If an incorrect tire pressure is set, these incorrect values will be monitored.

- ▶ Observe the notes in the section on tire pressures (▷ page 318).
- ▶ Make sure that the SmartKey is in position 2 (▷ page 147) in the ignition lock.
- ▶ Press the  or  button on the steering wheel to select the **Service** menu.

- ▶ Press the  or  button on the steering wheel to select the **Tire Pressure** menu.

- ▶ Press the  button.

The **Run Flat Indicator Active Press 'OK' to Restart** message appears in the multifunction display.

If you wish to confirm the restart:

- ▶ Press the  button.

The **Tire Pressure Now OK?** message appears in the multifunction display.

- ▶ Press the  or  button to select **Yes**.

- ▶ Press the  button.



The **Run Flat Indicator Restarted** message appears in the multifunction display.

After a teach-in period, the tire pressure loss warning system will monitor the set tire pressures of all four tires.

If you wish to cancel the restart:

- ▶ Press the  button.

or

- ▶ If the **Tire Pressure Now OK?** message appears, use the  or  button to select **Cancel**.

- ▶ Press the  button.

The tire pressure values stored at the last restart will continue to be monitored.

Tire pressure monitor

General notes

If a tire pressure monitor is installed, the vehicle's wheels have sensors that monitor the tire pressures in all four tires. The tire pressure monitor warns you if the pressure drops in one or more of the tires. The tire pressure monitor only functions if the corresponding sensors are installed on all wheels.

Information on tire pressures is displayed in the multifunction display. After a few minutes

of driving, the current tire pressure of each tire is shown in the **Service** menu of the multifunction display.

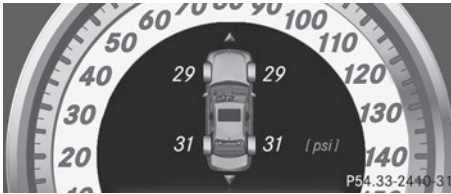

Example: current tire pressure display

For information on the message display, refer to the "Checking the tire pressure electronically" section (▷ page 324).

Important safety notes

WARNING

Each tire, including the spare (if provided), should be checked at least once a month when cold and inflated to the pressure recommended by the vehicle manufacturer on the Tire and Loading Information placard on the driver's door B-pillar or the tire pressure label on the inside of the fuel filler flap. If your vehicle has tires of a different size than the size indicated on the Tire and Loading Information placard or the tire pressure label, you should determine the proper tire pressure for those tires.

As an added safety feature, your vehicle has been equipped with a tire pressure monitoring system (TPMS) that illuminates a low tire pressure telltale when one or more of your tires are significantly underinflated.

Accordingly, when the low tire pressure telltale illuminates, you should stop and check your tires as soon as possible, and inflate them to the proper pressure. Driving on a significantly underinflated tire causes the tire to overheat and can lead to tire failure.

Underinflation also reduces fuel efficiency and tire tread life, and may affect the vehicle's handling and stopping ability.

Please note that the TPMS is not a substitute for proper tire maintenance, and it is the driver's responsibility to maintain correct tire

pressure, even if underinflation has not reached the level to trigger illumination of the TPMS low tire pressure telltale.

Your vehicle has also been equipped with a TPMS malfunction indicator to indicate if the system is not operating properly. The TPMS malfunction indicator is combined with the low tire pressure telltale. When the system detects a malfunction, the warning lamp will flash for approximately a minute and then remain continuously illuminated. This sequence will be repeated every time the vehicle is started as long as the malfunction exists.

When the malfunction indicator is illuminated, the system may not be able to detect or signal low tire pressure as intended. TPMS malfunctions may occur for a variety of reasons, including the installation of incompatible replacement or alternate tires or wheels on the vehicle that prevent the TPMS from functioning properly. Always check the TPMS malfunction telltale after replacing one or more tires or wheels on your vehicle to ensure that the replacement or alternate tires and wheels allow the TPMS to continue to function properly.

It is the driver's responsibility to set the tire pressure to that recommended for cold tires which is suitable for the operating situation (▷ page 318). Note that the correct tire pressure for the current operating situation must first be taught-in to the tire pressure monitor. If there is a substantial loss of pressure, the warning threshold for the warning message is aligned to the reference values taught-in. Restart the tire pressure monitor after adjusting the pressure of the cold tires (▷ page 325). The current pressures are saved as new reference values. As a result, a warning message will appear if the tire pressure drops significantly.

The tire pressure monitor does not warn you of an incorrectly set tire pressure. Observe the notes on the recommended tire pressure (▷ page 318).

The tire pressure monitor is not able to warn you of a sudden loss of pressure, e.g. if the tire is penetrated by a foreign object. In the event of a sudden loss of pressure, bring the vehicle to a halt by braking carefully. Avoid abrupt steering maneuvers.

The tire pressure monitor has a yellow warning lamp in the instrument cluster for indicating a pressure loss or malfunction. Whether the warning lamp flashes or lights up indicates whether a tire pressure is too low or the tire pressure monitor is malfunctioning:

- if the warning lamp is lit continuously, the tire pressure on one or more tires is significantly too low. The tire pressure monitor is not malfunctioning.
- if the warning lamp flashes for around a minute and then remains lit constantly, the tire pressure monitor is malfunctioning.

i In addition to the warning lamp, a message appears in the multifunction display.

Further information can be found on (> page 242).





If the tire pressure monitor is malfunctioning, it may take more than ten minutes for the tire pressure warning lamp to inform you of the malfunction by flashing for approximately one minute and then remaining lit. When the malfunction has been rectified, the tire pressure warning lamp goes out after a few minutes of driving.

The tire pressure values indicated by the on-board computer may differ from those measured at a gas station with a pressure gauge. The tire pressures shown by the on-board computer refer to those measured at sea level. At high altitudes, the tire pressure values indicated by a pressure gauge are higher than those shown by the on-board computer. In this case, do not reduce the tire pressures.

The operation of the tire pressure monitor can be affected by interference from radio transmitting equipment (e.g. radio

headphones, two-way radios) that may be being operated in or near the vehicle.

Checking the tire pressure electronically

- ▶ Make sure that the SmartKey is in position **2** in the ignition lock (> page 147).
- ▶ Press the  or  button on the steering wheel to select the **Service** menu.
- ▶ Press the  or  button to select **Tire Pressure**.
- ▶ Press the  button.
The current tire pressure of each tire is shown in the multifunction display.

If the vehicle has been parked for over 20 minutes, the **Tire pressures will be displayed after driving a few minutes** message appears.

After a teach-in process, the tire pressure monitor automatically detects new wheels or new sensors. As long as a clear allocation of the tire pressure value to the individual wheels is not possible, the **Tire Pressure Monitor Active** display message is shown instead of the tire pressure display. The tire pressures are already being monitored.

i If a spare wheel/emergency spare wheel is mounted, the system may continue to show the tire pressure of the wheel that has been removed for a few minutes. If this occurs, note that the value displayed for the position where the spare tire is mounted is not the same as the spare wheel/emergency spare wheel's current tire pressure.

Tire pressure monitor warning messages

If the tire pressure monitor detects a pressure loss in one or more tires, a warning message is shown in the multifunction display and the yellow tire pressure monitor warning lamp comes on.







- If the **Correct Tire Pressure** message appears in the multifunction display, the tire pressure in at least one tire is too low and must be corrected at the next opportunity.
- If the **Check Tires** message appears in the multifunction display, the tire pressure in one or more tires has dropped significantly and the tires must be checked.
- If the **Warning Tire Malfunction** appears in the multifunction display, the tire pressure in one or more tires has dropped suddenly and the tires must be checked.

Observe the instructions and safety notes in the display messages in the "Tires" section (▷ page 242).

- ❗ If the wheel positions on the vehicle are rotated, the tire pressures may be displayed for the wrong positions for a short time. This is rectified after a few minutes of driving, and the tire pressures are displayed for the correct positions.

Restarting the tire pressure monitor

When you restart the tire pressure monitor, all existing warning messages are deleted and the warning lamps go out. The monitor uses the currently set tire pressures as the reference values for monitoring. In most cases, the tire pressure monitor will automatically detect the new reference values after you have changed the tire pressure. However, you can also define reference values manually as described here. The tire pressure monitor then monitors the new tire pressure values.

- ▶ Set the tire pressure to the value recommended for the corresponding driving situation on the Tire and Loading Information placard on the driver's side B-pillar (▷ page 318).
Additional tire pressure values for different loads can also be found on the tire pressure table on the inside of the fuel filler flap (▷ page 318).
- ▶ Make sure that the tire pressure is correct on all four wheels.
- ▶ Make sure that the SmartKey is in position **2** in the ignition lock.
- ▶ Press the  or  button on the steering wheel to select the **Service** menu.
- ▶ Press the  or  button to select **Tire Pressure**.
- ▶ Press the  button.
The multifunction display shows the current tire pressure for the individual tires or the **Tire pressures will be displayed after driving a few minutes** message.
- ▶ Press the  button.
The **Use Current Pressures as New Reference Values** message appears in the multifunction display.

If you wish to confirm the restart:

- ▶ Press the  button.
The **Tire Press. Monitor Restarted** message appears in the multifunction display.

After driving for a few minutes, the system checks whether the current tire pressures are within the specified range. The new tire pressures are then accepted as reference values and monitored.

If you wish to cancel the restart:

- ▶ Press the  button.
The tire pressure values stored at the last restart will continue to be monitored.

Loading the vehicle

Instruction labels for tires and loads

WARNING

Overloaded tires can overheat, causing a blowout. Overloaded tires can also impair the steering and driving characteristics and lead to brake failure. There is a risk of accident.

Observe the load rating of the tires. The load rating must be at least half of the GAWR of your vehicle. Never overload the tires by exceeding the maximum load.

Two instruction labels on your vehicle show the maximum possible load.

- (1) The Tire and Loading Information placard is on the B-pillar on the driver's side. The Tire and Loading Information placard shows the maximum permissible number of occupants and the maximum permissible vehicle load. It also contains details of the tire sizes and corresponding pressures for tires mounted at the factory.
- (2) The vehicle identification plate is on the B-pillar on the driver's side. The vehicle identification plate informs you of the gross vehicle weight rating. It is made up of the vehicle weight, all vehicle occupants, the fuel and the cargo. You can also find information about the maximum gross axle weight rating on the front and rear axle.

The maximum gross axle weight rating is the maximum weight that can be carried by one axle (front or rear axle). Never exceed the maximum load or the maximum gross axle weight rating for the front or rear axle.

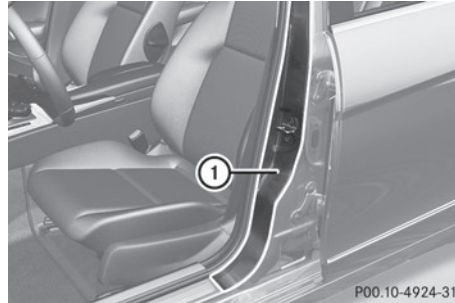

① B-pillar, driver's side

Maximum permissible load

-  The specifications shown on the Tire and Loading Information placard in the illustration are examples. The maximum permissible load is vehicle-specific and may deviate from the data shown here. The maximum permissible load that applies for your vehicle can be found on your vehicle's Tire and Loading Information placard.

TIRE		LOADING INFORMATION	
RENSEIGNEMENTS		SUR LES PNEUS ET LE CHARGEMENT	
SEATING CAPACITY NOMBRE DE PLACES	TOTAL	FRONT AVANT	MIDDLE MILIEU
7	7	2	2
The combined weight of occupants and cargo should never exceed Le poids total des occupants et du chargement ne doit jamais dépasser			
		XXX	kg or XXX lbs.* kg ou XXX lb.*
TIRE PNEU	SIZE DIMENSIONS	COLD TIRE PRESSURE PRESSION DES PNEUS À FROID	
FRONT AVANT	255/40 ZR18 99Y XL	200 KPA, 29 PSI	
REAR ARRIÈRE	285/35 ZR18 101Y XL	200 KPA, 29 PSI	
Spare DE SECOURS	175/55-18 95P	420 KPA, 40 PSI	
			SEE OWNER'S MANUAL FOR ADDITIONAL INFORMATION VOIR LE MANUEL DE L'USAGER POUR PLUS DE RENSEIGNEMENTS

P40.00-2206-31

- Specification for maximum permissible load ① is listed on the Tire and Loading Information placard: "The combined weight of occupants and cargo should never exceed XXX kilograms or XXX lbs."

The gross weight of all vehicle occupants, load, luggage and trailer load/noseweight (if applicable) must not exceed the specified value.

Number of seats

i The specifications shown on the Tire and Loading Information placard in the illustration are examples. The number of seats is vehicle-specific and can differ from the details shown. The number of seats in your vehicle can be found on the Tire and Loading Information placard.

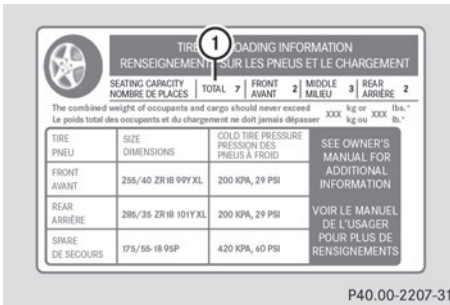

Maximum number of seats ① indicates the maximum number of occupants allowed to travel in the vehicle. This information can be found on the Tire and Loading Information placard.

Determining the correct load limit

Step-by-step instructions

The following steps have been developed as required of all manufacturers under Title 49, Code of U.S. Federal Regulations, Part 575 pursuant to the "National Traffic and Motor Vehicle Safety Act of 1966".

- ▶ **Step 1:** Locate the statement "The combined weight of occupants and cargo should never exceed XXX kg or XXX lbs." on your vehicle's Tire and Loading Information placard.
- ▶ **Step 2:** Determine the combined weight of the driver and passengers that will be riding in your vehicle.
- ▶ **Step 3:** Subtract the combined weight of the driver and passengers from XXX kilograms or XXX lbs.

▶ **Step 4:** The resulting figure equals the available amount of cargo and luggage load capacity. For example, if the "XXX" amount equals 1400 lbs and there will be five 150 lbs passengers in your vehicle, the amount of available cargo and luggage load capacity is 650 lbs (1 400 - 750 (5 x 150) = 650 lbs).

▶ **Step 5:** Determine the combined weight of luggage and cargo being loaded on the vehicle. That weight may not safely exceed the available cargo and luggage load capacity calculated in step 4.

▶ **Step 6 (if applicable):** If your vehicle will be towing a trailer, load from your trailer will be transferred to your vehicle. Refer to this Operator's Manual to determine how this reduces the available cargo and luggage load capacity of your vehicle (▷ page 329).

Example: steps 1 to 3

The following table shows examples on how to calculate total and cargo load capacities with varying seating configurations and number and size of occupants. The following examples use a load limit of 1 500 lbs (680 kg). **This is for illustration purposes only.** Make sure you are using the actual load limit for your vehicle stated on your vehicle's Tire and Loading Information placard (▷ page 327).

		Example 1	Example 2	Example 3
Step 1	Combined maximum weight of occupants and cargo (data from the Tire and Loading Information placard)	1500 lbs (680 kg)	1500 lbs (680 kg)	1500 lbs (680 kg)

		Example 1	Example 2	Example 3
Step 2	Number of people in the vehicle (driver and occupants)	5	3	1
	Distribution of the occupants	Front: 2 Rear: 3	Front: 1 Rear: 2	Front: 1
	Weight of the occupants	Occupant 1: 150 lbs (68 kg) Occupant 2: 180 lbs (82 kg) Occupant 3: 160 lbs (73 kg) Occupant 4: 140 lbs (63 kg) Occupant 5: 120 lbs (54 kg)	Occupant 1: 200 lbs (91 kg) Occupant 2: 190 lbs (86 kg) Occupant 3: 150 lbs (68 kg)	Occupant 1: 150 lbs (68 kg)
	Gross weight of all occupants	750 lbs (340 kg)	540 lbs (245 kg)	150 lbs (68 kg)

		Example 1	Example 2	Example 3
Step 3	Permissible load and trailer load/noseweight (maximum permissible load rating from the Tire and Loading Information placard minus the gross weight of all occupants)	1500 lbs (680 kg) - 750 lbs (340 kg) = 750 lbs (340 kg)	1500 lbs (680 kg) - 540 lbs (245 kg) = 960 lbs (435 kg)	1500 lbs (680 kg) - 150 lbs (68 kg) = 1350 lbs (612 kg)

The higher the weight of all the occupants, the smaller the maximum load for luggage. Further information can be found under "Towing a trailer" (> page 329).

Vehicle identification plate

Even if you have calculated the total load carefully, you should still make sure that the gross vehicle weight rating and the gross axle weight rating are not exceeded. Details can be found on the vehicle identification plate on the B-pillar on the driver's side of the vehicle (> page 326).

Permissible gross vehicle weight: the gross weight of the vehicle, all passengers, load and trailer load/noseweight (if applicable) must not exceed the permissible gross vehicle weight.

Gross axle weight rating: the maximum permissible weight that can be carried by one axle (front or rear axle).

To ensure that your vehicle does not exceed the maximum permissible values (gross vehicle weight and maximum gross axle weight rating), have your loaded vehicle (including driver, occupants, cargo, and full trailer load if applicable) weighed on a suitable vehicle weighbridge.

Trailer load/noseweight

The trailer load/noseweight affects the gross weight of the vehicle. If a trailer is attached,

the trailer load/noseweight is included in the load along with occupants and luggage. The trailer load/noseweight is usually approximately 10% of the gross weight of the trailer and its load.

Your Mercedes-Benz has been designed primarily to carry passengers and their luggage. Mercedes-Benz does not recommend towing a trailer with your vehicle.

Maximum load rating

Do not overload the tires by exceeding the specified load limit. The maximum permissible load can be found on the vehicle's Tire and Loading Information placard on the B-pillar on the driver's side (> page 326).



i The actual values for tires are vehicle-specific and may deviate from the values in the illustration.

Maximum tire load **①** is the maximum permissible weight for which the tire is approved.

i The actual values for tires are vehicle-specific and may deviate from the values in the illustration.

Where applicable, the tire grading information can be found on the tire sidewall between the tread shoulder and maximum tire width.

For example:

Treadwear	Traction	Temperature
200	AA	A

All passenger car tires must conform to the statutory safety requirements in addition to these grades.

Uniform Tire Quality Grading Standards

Overview of Tire Quality Grading Standards

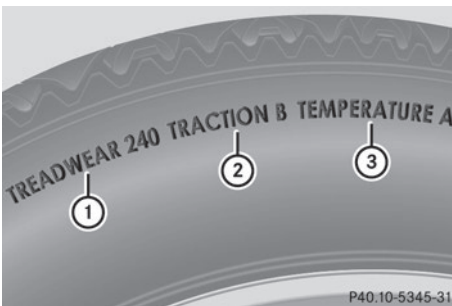

Uniform Tire Quality Grading Standards are U.S. government specifications. Their purpose is to provide drivers with uniform reliable information on tire performance data. Tire manufacturers have to grade tires using three performance factors: tread wear **①**, tire traction **②** and heat resistance **③**. All tires sold in North America are provided with the corresponding quality class mark on the sidewall of the tire, even though these regulations do not apply to Canada.

Treadwear

The treadwear grade is a comparative rating based on the wear rate of the tire when tested under controlled conditions on a specified U.S. government course. For example, a tire graded 150 would wear one and one-half times as well on the government course as a tire graded 100.

The relative performance of tires depends upon the actual conditions of their use, however, and may depart significantly from the norm, due to variations in driving habits, service practices and differences in road characteristics and climate conditions.

Traction

⚠ WARNING

The traction grade assigned to this tire is based on straight-ahead braking traction tests, and does not include acceleration, cornering, hydroplaning, or peak traction characteristics.

The traction grades, from highest to lowest, are AA, A, B, and C. Those grades represent the tire's ability to stop on a wet surface as measured under controlled conditions on

specified government test surfaces of asphalt and concrete. A tire marked C may have poor traction performance.

The safe speed on a wet, snow covered or icy road is always lower than on dry road surfaces.

You should pay special attention to road conditions when temperatures are around the freezing point.

Mercedes-Benz recommends a minimum tread depth of $\frac{1}{8}$ in (4 mm) for all four winter tires (▷ page 316) to maintain normal driving characteristics in winter. Winter tires can reduce the braking distance on snow-covered surfaces in comparison with summer tires. Stopping distance, however, is still considerably greater than when the road is not covered with ice or snow. Take appropriate care when driving.

! Avoid wheelspin. This can lead to damage to the drive train.

Temperature

! WARNING

The temperature grade for this tire is established for a tire that is properly inflated and not overloaded. Excessive speed, underinflation, or excessive loading, either separately or in combination, can cause excessive heat build-up and possible tire failure.

The temperature grades are A (the highest), B, and C. These represent the tire's resistance to the generation of heat and its ability to dissipate heat when tested under controlled conditions on a specified indoor laboratory test wheel. Sustained high temperature can cause the material of the tire to degenerate and reduce tire life, and excessive temperature can lead to sudden tire failure. The grade C corresponds to a level of performance which all passenger car tires must meet under the Federal Motor Vehicle Safety Standard No. 109. Grades B and A

represent higher levels of performance on the laboratory test wheel than the minimum required by law.

Tire labeling

Overview of tire labeling

The following markings are on the tire in addition to the tire name (sales designation) and the manufacturer's name:

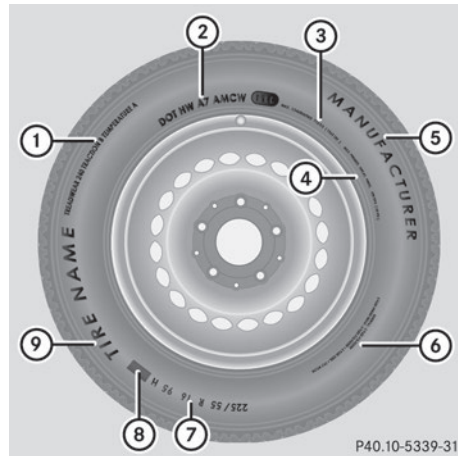

- ① Uniform Tire Quality Grading Standard (▷ page 335)
 - ② DOT, Tire Identification Number (▷ page 334)
 - ③ Maximum tire load (▷ page 329)
 - ④ Maximum tire pressure (▷ page 320)
 - ⑤ Manufacturer
 - ⑥ Tire material (▷ page 335)
 - ⑦ Tire size designation, load-bearing capacity and speed index (▷ page 332)
 - ⑧ Load index (▷ page 334)
 - ⑨ Tire name
- i** Tire data is vehicle-specific and may deviate from the data in the example.

Tire size designation, load-bearing capacity and speed rating

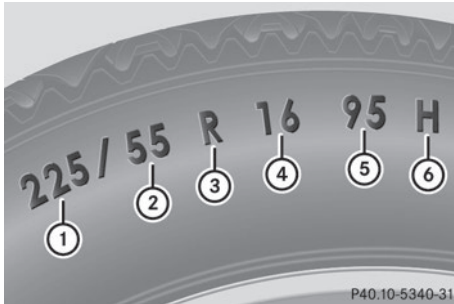

- ① Tire width
 - ② Nominal aspect ratio in %
 - ③ Tire code
 - ④ Rim diameter
 - ⑤ Load bearing index
 - ⑥ Speed rating
- i** Tire data is vehicle-specific and may deviate from the data in the example.

General: depending on the manufacturer's standards, the size imprinted in the tire wall may not contain any letters or may contain one letter that precedes the size description.

If there is no letter preceding the size description (as shown above): these are passenger vehicle tires according to European manufacturing standards.

If "P" precedes the size description: these are passenger vehicle tires according to U.S. manufacturing standards.

If "LT" precedes the size description: these are light truck tires according to U.S. manufacturing standards.

If "T" precedes the size description: these are compact emergency spare wheels at high tire pressure, to be used only temporarily in an emergency.

Tire width: tire width ① shows the nominal tire width in millimeters.

Height-width ratio: aspect ratio ② is the size ratio between the tire height and tire width and is shown in percent. The aspect

ratio is calculated by dividing the tire width by the tire height.

Tire code: tire code ③ specifies the tire type. "R" represents radial tires; "D" represents diagonal tires; "B" represents diagonal radial tires.

Optionally, tires with a maximum speed of over 149 mph (240 km/h) may have "ZR" in the size description, depending on the manufacturer (e.g. 245/40 ZR 18).

Rim diameter: rim diameter ④ is the diameter of the bead seat, not the diameter of the rim flange. The rim diameter is specified in inches (in).

Load-bearing index: load-bearing index ⑤ is a numerical code that specifies the maximum load-bearing capacity of a tire.

Do not overload the tires by exceeding the specified load limit. The maximum permissible load can be found on the vehicle's Tire and Loading Information placard on the B-pillar on the driver's side (▷ page 326).

Example:

Load-bearing index 91 indicates a maximum load of 1,356 lb (615 kg) that the tires can bear. For further information on the maximum tire load in kilograms and lbs, see (▷ page 329).

For further information on the load bearing index, see "Load index" (▷ page 334).

Speed rating: speed rating ⑥ specifies the approved maximum speed of the tire.

⚠ WARNING

Exceeding the stated tire load-bearing capacity and the approved maximum speed could lead to tire damage or the tire bursting. There is a risk of accident.

Therefore, only use tire types and sizes approved for your vehicle model. Observe the tire load rating and speed rating required for your vehicle.

Regardless of the speed rating, always observe the speed limits. Drive carefully and

adapt your driving style to the traffic conditions.

Summer tires	
Index	Speed rating
Q	up to 100 mph (160 km/h)
R	up to 106 mph (170 km/h)
S	up to 112 mph (180 km/h)
T	up to 118 mph (190 km/h)
H	up to 130 mph (210 km/h)
V	up to 149 mph (240 km/h)
W	up to 168 mph (270 km/h)
Y	up to 186 mph (300 km/h)
ZR...Y	up to 186 mph (300 km/h)
ZR...(..Y)	over 186 mph (300 km/h)
ZR	over 149 mph (240 km/h)

- Optionally, tires with a maximum speed of over 149 mph (240 km/h) may have "ZR" in the size description, depending on the manufacturer (e.g. 245/40 ZR 18). The service specification is made up of load-bearing index (5) and speed rating (6).
- If the size description of your tire includes "ZR" and there are no service specifications, ask the tire manufacturer in order to find out the maximum speed. If a service specification is available, the maximum speed is limited according to the speed rating in the service specification. Example: 245/40 ZR 18 97 Y. In this example, "97 Y" is the service specification. The letter "Y" represents the speed rating. The maximum speed of the tire is limited to 186 mph (300 km/h).
- The size description for all tires with maximum speeds of over 186 mph

(300 km/h) must include "ZR", **and** the service specification must be given in parentheses. Example: 275/40 ZR 18 (99 Y). Speed rating "(Y)" indicates that the maximum speed of the tire is over 186 mph (300 km/h). Ask the tire manufacturer about the maximum speed.

All-weather tires and winter tires	
Index	Speed rating
Q M+S ¹²	up to 100 mph (160 km/h)
T M+S ¹²	up to 118 mph (190 km/h)
H M+S ¹²	up to 130 mph (210 km/h)
V M+S ¹²	up to 149 mph (240 km/h)

- i** Not all tires with the M+S marking provide the driving characteristics of winter tires. In addition to the M+S marking, winter tires also have the  snowflake symbol on the tire wall. Tires with this marking fulfill the requirements of the Rubber Manufacturers Association (RMA) and the Rubber Association of Canada (RAC) regarding snow traction, and were specially developed for driving on snow.

An electronic speed limiter prevents your vehicle from exceeding the following speeds:

- all vehicles (except AMG vehicles): 130 mph (210 km/h)
- AMG vehicles: 155 mph (250 km/h)
- AMG vehicles with increased top speed: 174 mph (280 km/h)

The speed rating of tires mounted at the factory may be higher than the maximum speed that the electronic speed limiter permits.

Make sure that your tires have the required speed rating for your vehicle as specified in the "tires" section (▷ page 342), e.g. if you buy new tires.

¹² Or M+S  for winter tires.

Further information about reading tire data can be obtained from any qualified specialist workshop.

Load index



i Tire data is vehicle-specific and may deviate from the data in the example.

In addition to the load-bearing index, load index ① may be imprinted after the letters that identify speed rating ⑥ (▷ page 332) on the sidewall of the tire.

- If no specification is given: no text (as in the example above), represents a standard load (SL) tire
- XL or Extra Load: represents a reinforced tire
- Light Load: represents a light load tire
- C, D, E: represents a load range that depends on the maximum load that the tire can carry at a certain pressure

DOT, Tire Identification Number (TIN)

U.S. tire regulations prescribe that every manufacturer of new tires or retreader has to imprint a TIN in or on the sidewall of each tire produced.

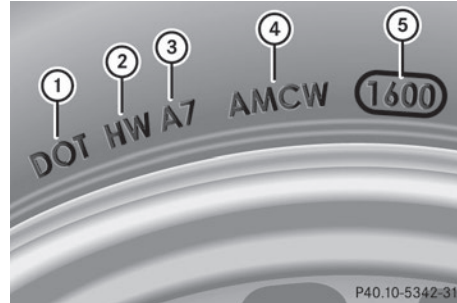

The TIN is a unique identification number. The TIN enables tire manufacturers to inform purchasers of recalls and other safety-relevant matters. It makes it possible for the purchaser to easily identify the affected tires. The TIN is made up of manufacturer identification code ②, tire size ③, tire type code ④ and manufacturing date ⑤.

i Tire data is vehicle-specific and may deviate from the data in the example.

DOT (Department of Transportation): tire symbol ① indicates that the tire complies with the requirements of the U.S. Department of Transportation.

Manufacturer identification code: manufacturer identification code ② provides details on the tire manufacturer. New tires have a code with two symbols. Retreaded tires have a code with four symbols.

For further information about retreaded tires, see (▷ page 314).

Tire size: identifier ③ describes the tire size.

Tire type code: tire type code ④ can be used by the manufacturer as a code to describe specific characteristics of the tire.

Date of manufacture: date of manufacture ⑤ provides information about the age of a tire. The first and second positions represent the week of manufacture, starting with "01" for the first calendar week. Positions three and four represent the year of manufacture. For example, a tire that is marked with "3208", was manufactured in week 32 in 2008.

Tire characteristics

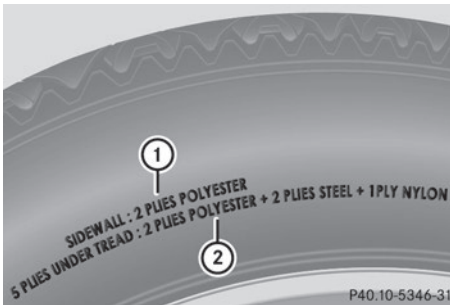

i Tire data is vehicle-specific and may deviate from the data in the example.

This information describes the type of tire cord and the number of layers in sidewall ① and under tire tread ②.

Definition of terms for tires and loading

Tire ply composition and material used

Describes the number of plies or the number of layers of rubber-coated fabric in the tire tread and sidewall. These are made of steel, nylon, polyester and other materials.

Bar

Metric unit for tire pressure. 14.5038 pounds per square inch (psi) and 100 kilopascals (kPa) are the equivalent of 1 bar.

DOT (Department of Transportation)

DOT marked tires fulfill the requirements of the United States Department of Transportation.

Normal occupant weight

The number of occupants for which the vehicle is designed multiplied by 68 kilograms (150 lbs).

Uniform Tire Quality Grading Standards

A uniform standard to grade the quality of tires with regards to tread quality, tire traction and temperature characteristics. Ratings are determined by tire manufacturers using U.S. government testing procedures. The ratings are molded into the sidewall of the tire.

Recommended tire pressure

The recommended tire pressure applies to the tires mounted at the factory.

The Tire and Loading Information placard contains the recommended tire pressures for cold tires on a fully loaded vehicle and for the maximum permissible vehicle speed.

The tire pressure table contains the recommended pressures for cold tires for various operating conditions, i.e. differing load and speed conditions.

Increased vehicle weight due to optional equipment

This is the combined weight of all standard and optional equipment available for the vehicle, regardless of whether it is actually installed on the vehicle or not.

Rim

This is the part of the wheel on which the tire is mounted.

GAWR (Gross Axle Weight Rating)

The GAWR is the maximum gross axle weight rating. The actual load on an axle must never exceed the gross axle weight rating. The gross axle weight rating can be found on the vehicle identification plate on the B-pillar on the driver's side.

Speed rating

The speed rating is part of the tire identification. It specifies the speed range for which the tire is approved.

GVW (Gross Vehicle Weight)

The gross vehicle weight includes the weight of the vehicle including fuel, tools, the spare wheel, accessories installed, occupants, luggage and the drawbar noseweight, if applicable. The gross vehicle weight must not exceed the gross vehicle weight rating GVWR as specified on the vehicle identification plate on the B-pillar on the driver's side.

GVWR (Gross Vehicle Weight Rating)

The GVWR is the maximum permissible gross weight of a fully loaded vehicle (the weight of the vehicle including all accessories, occupants, fuel, luggage and the drawbar noseweight, if applicable). The gross vehicle weight rating is specified on the vehicle identification plate on the B-pillar on the driver's side.

Maximum loaded vehicle weight

The maximum weight is the sum of the curb weight of the vehicle, the weight of the accessories, the total load limit and the weight of the optional equipment installed at the factory.

Kilopascal (kPa)

Metric unit for tire pressure. 6.9 kPa corresponds to 1 psi. Another unit for tire pressure is bar. 100 kilopascals (kPa) are the equivalent of 1 bar.

Load index

In addition to the load-bearing index, the load index may also be imprinted on the sidewall of the tire. This specifies the load-bearing capacity more precisely.

Curb weight

The weight of a vehicle with standard equipment including the maximum capacity of fuel, oil and coolant. It also includes the air-conditioning system and optional equipment if these are installed in the vehicle, but does not include passengers or luggage.

Maximum load rating

The maximum load rating in kilograms or pounds is the maximum weight for which a tire is approved.

Maximum permissible tire pressure

Maximum permissible tire pressure for one tire.

Maximum load on one tire

Maximum load on one tire. This is calculated by dividing the maximum axle load of one axle by two.

PSI (pounds per square inch)

A standard unit of measure for tire pressure.

Aspect ratio

Relationship between tire height and tire width in percent.

Tire pressure

This is pressure inside the tire applying an outward force to each square inch of the tire's surface. The tire pressure is specified in pounds per square inch (psi), in kilopascal (kPa) or in bar. The tire pressure should only be corrected when the tires are cold.

Tire pressure of cold tires

The tires are cold:

- if the vehicle has been parked without direct sunlight on the tires for at least three hours and
- if the vehicle has not been driven further than 1 mile (1.6 km)

Tread

The part of the tire that comes into contact with the road.

Bead

The tire bead ensures that the tire sits securely on the wheel. There are several steel wires in the bead to prevent the tire from coming loose from the wheel rim.

Sidewall

The part of the tire between the tread and the bead.

Weight of optional extras

The combined weight of those optional extras that weigh more than the replaced standard parts and more than 2.3 kg (5 lbs). These

optional extras, such as high-performance brakes, level control, a roof rack or a high-performance battery, are not included in the curb weight and the weight of the accessories.

TIN (Tire Identification Number)

This is a unique identifier which can be used by a tire manufacturer to identify tires, for example for a product recall, and thus identify the purchasers. The TIN is made up of the manufacturer's identity code, tire size, tire type code and the manufacturing date.

Load bearing index

The load bearing index (also load index) is a code that contains the maximum load bearing capacity of a tire.

Traction

Traction is the result of friction between the tires and the road surface.

Treadwear indicators

Narrow bars (tread wear bars) that are distributed over the tire tread. If the tire tread is level with the bars, the wear limit of $\frac{1}{16}$ in (1.6 mm) has been reached.

Occupant distribution

The distribution of occupants in a vehicle at their designated seating positions.

Total load limit

Nominal load and luggage load plus 68 kg (150 lbs) multiplied by the number of seats in the vehicle.

Changing a wheel

Flat tire

You can find information on what to do in the event of a flat tire in the "Flat tire" section (▷ page 301).

Information on driving with MOExtended tires in the event of a flat tire can be found under "MOExtended tires (tires with run-flat characteristics)" (▷ page 301).

Rotating the wheels

WARNING

Interchanging the front and rear wheels may severely impair the driving characteristics if the wheels or tires have different dimensions. The wheel brakes or suspension components may also be damaged. There is a risk of accident.

Rotate front and rear wheels only if the wheels and tires are of the same dimensions.

! On vehicles equipped with a tire pressure monitor, electronic components are located in the wheel.

Tire-mounting tools should not be used near the valve. This could damage the electronic components.

Only have tires changed at a qualified specialist workshop.

Always observe the instructions and safety notes in the "Mounting a wheel" section (▷ page 338).

The wear patterns on the front and rear tires differ, depending on the operating conditions. Rotate the wheels before a clear wear pattern has formed on the tires. Front tires typically wear more on the shoulders and the rear tires in the center.

If your vehicle's tire configuration allows, you can rotate the wheels according to the intervals in the tire manufacturer's warranty book in your vehicle documents. If no warranty book is available, the tires should be

rotated every 3,000 to 6,000 miles (5,000 to 10,000 km), or earlier if tire wear requires. Do not change the direction of wheel rotation.

Clean the contact surfaces of the wheel and the brake disc thoroughly every time a wheel is rotated. Check the tire pressures.

Information on changing tires and mounting the spare wheel (▷ page 338).

Direction of rotation

Tires with a specified direction of rotation have additional benefits, e.g. if there is a risk of hydroplaning. You will only gain these benefits if the correct direction of rotation is maintained.

An arrow on the sidewall of the tire indicates its correct direction of rotation.

Storing wheels

Store wheels that are not being used in a cool, dry and preferably dark place. Protect the tires from oil, grease, gasoline and diesel.

Cleaning the wheels

WARNING

The water jet from a circular jet nozzle (dirt blasters) can cause invisible exterior damage to the tires or chassis components.

Components damaged in this way may fail unexpectedly. There is a risk of an accident.

Do not use power washers with circular jet nozzles to clean the vehicle. Have damaged tires or chassis components replaced immediately.

Mounting a wheel

Preparing the vehicle

- ▶ Stop the vehicle on solid, non-slippery and level ground.
- ▶ Apply the parking brake.

- ▶ Bring the front wheels into the straight-ahead position.
- ▶ Move the selector lever to position **P**.
- ▶ Switch off the engine.
- ▶ **Vehicles without KEYLESS-GO:** remove the SmartKey from the ignition lock.
- ▶ **Vehicles with KEYLESS-GO:** open the driver's door. The on-board electronics have status **0**, which is the same as the SmartKey having been removed.
- ▶ **Vehicles with KEYLESS-GO:** remove the Start/Stop button from the ignition lock (> page 148).
- ▶ If included in the vehicle equipment, remove the tire-change tool kit from the vehicle.
- ▶ Secure the vehicle to prevent it from rolling away.

Securing the vehicle to prevent it from rolling away

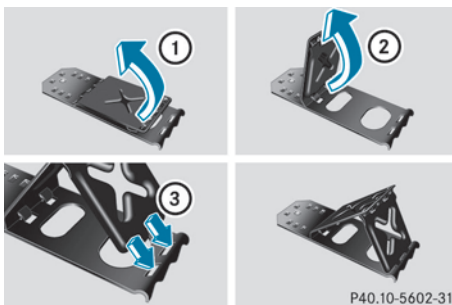

If your vehicle is equipped with a wheel chock, it can be found in the tire-change tool kit (> page 300).

The folding wheel chock is an additional safety measure to prevent the vehicle from rolling away, for example when changing a wheel.

- ▶ Fold both plates upwards ①.
- ▶ Fold out lower plate ②.
- ▶ Guide the lugs on the lower plate fully into the openings in base plate ③.



Securing the vehicle on level ground

- ▶ **On level ground:** place chocks or other suitable items under the front and rear of the wheel that is diagonally opposite the wheel you wish to change.

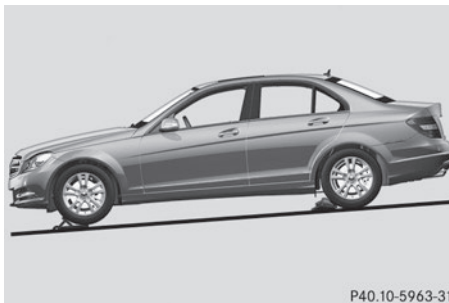

Securing the vehicle on slight downhill gradients

- ▶ **On light downhill gradients:** place chocks or other suitable items in front of the wheels of the front and rear axle.

Raising the vehicle

WARNING

If you do not position the jack correctly at the appropriate jacking point of the vehicle, the jack could tip over with the vehicle raised. There is a risk of injury.

Only position the jack at the appropriate jacking point of the vehicle. The base of the

jack must be positioned vertically, directly under the jacking point of the vehicle.

The following must be observed when raising the vehicle:

- to raise the vehicle, only use the vehicle-specific jack that has been tested and approved by Mercedes-Benz. If used incorrectly, the jack could tip over with the vehicle raised.
- the jack is designed only to raise and hold the vehicle for a short time while a wheel is being changed. It is not suited for performing maintenance work under the vehicle.
- avoid changing the wheel on uphill and downhill slopes.
- before raising the vehicle, secure it from rolling away by applying the parking brake and inserting wheel chocks. Never disengage the parking brake while the vehicle is raised.
- the jack must be placed on a firm, flat and non-slip surface. On a loose surface, a large, load-bearing underlay must be used. On a slippery surface, a non-slip underlay must be used, e.g. rubber mats.
- do not use wooden blocks or similar objects as a jack underlay. Otherwise, the jack will not be able to achieve its load-bearing capacity due to the restricted height.
- make sure that the distance between the underside of the tires and the ground does not exceed 1.2 inches (3 cm).
- never place your hands and feet under the raised vehicle.
- never lie under the raised vehicle.
- never start the engine when the vehicle is raised.
- never open or close a door or the trunk lid when the vehicle is raised.
- make sure that no persons are present in the vehicle when the vehicle is raised.

! The jack is designed exclusively for jacking up the vehicle at the jacking points. Otherwise, your vehicle could be damaged.



- Using lug wrench (1), loosen the bolts on the wheel you wish to change by about one full turn. Do not unscrew the bolts completely.

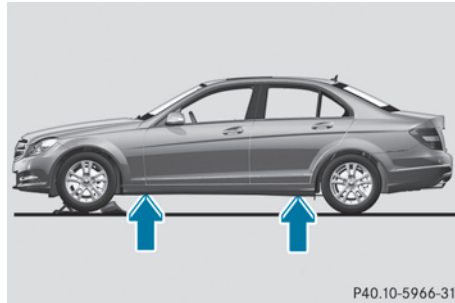

The jacking points are located just behind the wheel housings of the front wheels and just in front of the wheel housings of the rear wheels (arrows).

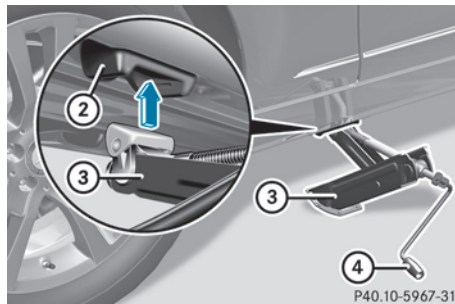

- Position jack (3) at jacking point (2).

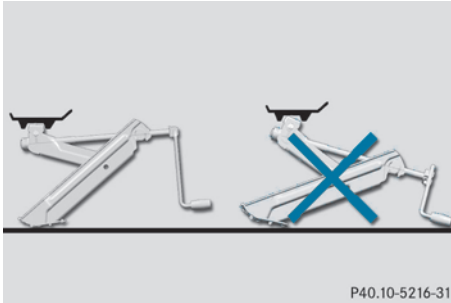

- ▶ Make sure the foot of the jack is directly beneath the jacking point.
- ▶ Turn crank ④ clockwise until jack ③ sits completely on jacking point ② and the base of the jack lies evenly on the ground.
- ▶ Turn crank ④ until the tire is raised a maximum of 1.2 in (3 cm) from the ground.

Removing a wheel

- ❗ Do not place wheel bolts in sand or on a dirty surface. The bolt and wheel hub threads could otherwise be damaged when you screw them in.
- ▶ Unscrew the wheel bolts.
- ▶ Remove the wheel.

Mounting a new wheel

⚠ WARNING

Oiled or greased wheel bolts or damaged wheel bolts/hub threads can cause the wheel bolts to come loose. As a result, you could lose a wheel while driving. There is a risk of accident.

Never oil or grease wheel bolts. In the event of damage to the threads, contact a qualified specialist workshop immediately. Have the damaged wheel bolts or hub threads replaced/renewed. Do not continue driving.

⚠ WARNING

If you tighten the wheel bolts or wheel nuts when the vehicle is raised, the jack could tip over. There is a risk of injury.

Only tighten the wheel bolts or wheel nuts when the vehicle is on the ground.

Always pay attention to the instructions and safety notes in the "Changing a wheel" section (> page 338).

Only use wheel bolts that have been designed for the wheel and the vehicle. For safety reasons, Mercedes-Benz recommends that you only use wheel bolts which have been approved for Mercedes-Benz vehicles and the respective wheel.

Be sure to use the original-length wheel bolts when re-mounting the original wheel after it has been repaired.

- ❗ To prevent damage to the paintwork, hold the wheel securely against the wheel hub while screwing in the first wheel bolt.

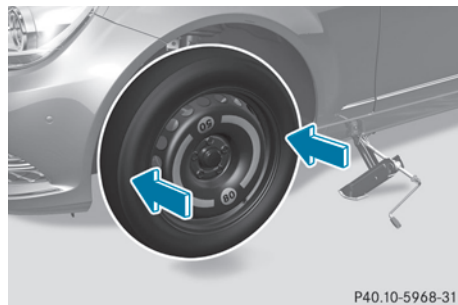

- ▶ Clean the wheel and wheel hub contact surfaces.
- ▶ Place the new wheel on the wheel hub and push it on.
- ▶ Tighten the wheel bolts until they are finger-tight.

Lowering the vehicle

WARNING

The wheels could work loose if the wheel nuts and bolts are not tightened to the specified tightening torque. There is a risk of accident.

Have the tightening torque immediately checked at a qualified specialist workshop after a wheel is changed.

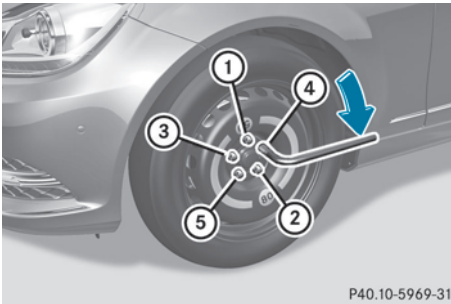

- ▶ Turn the crank of the jack counter-clockwise until the vehicle is once again standing firmly on the ground.
 - ▶ Place the jack to one side.
 - ▶ Tighten the wheel bolts evenly in a crosswise pattern in the sequence indicated (① to ⑤). The tightening torque must be **96 lb-ft (130 Nm)**.
 - ▶ Turn the jack back to its initial position and store it together with the rest of the tire-change tool kit in the trunk/cargo compartment.
 - ▶ Transport the faulty wheel in the trunk/cargo compartment.
- or
- ▶ Depending on the size of the wheel, you may also be able to secure the defective wheel in the spare wheel well. In this case, you will have to remove the stowage well casing from the spare wheel well and stow it securely in the trunk/cargo compartment.
 - ▶ Check the tire pressure of the newly mounted wheel and adjust it if necessary.

Observe the recommended tire pressure (▷ page 318).

- i** Vehicles with tire pressure monitor: all wheels mounted must be equipped with functioning sensors.

Wheel and tire combinations

General notes

- !** For safety reasons, Mercedes-Benz recommends that you only use tires and wheels which have been approved by Mercedes-Benz specifically for your vehicle.

These tires have been specially adapted for use with the control systems, such as ABS or ESP®, and are marked as follows:

- MO = Mercedes-Benz Original
- MOE = Mercedes-Benz Original Extended (tires featuring run-flat characteristics)
- MO1 = Mercedes-Benz Original (only certain AMG tires)

Mercedes-Benz Original Extended tires may only be used on wheels that have been specifically approved by Mercedes-Benz.

Only use tires, wheels or accessories tested and approved by Mercedes-Benz. Certain characteristics, e.g. handling, vehicle noise emissions or fuel consumption, may otherwise be adversely affected. In addition, when driving with a load, tire dimension variations could cause the tires to come into contact with the bodywork and axle components. This could result in damage to the tires or the vehicle.

Mercedes-Benz accepts no liability for damage resulting from the use of tires, wheels or accessories other than those tested and approved.

Information on tires, wheels and approved combinations can be obtained from any qualified specialist workshop.

- !** Retreaded tires are neither tested nor recommended by Mercedes-Benz, since

previous damage cannot always be detected on retreaded tires. As a result, Mercedes-Benz cannot guarantee vehicle safety if retreaded tires are mounted. Do not mount used tires if you have no information about their previous usage.

- i** The recommended pressures for various operating conditions can be found:
 - on the Tire and Loading Information placard with the recommended tire pressures on the B-pillar on the driver's side
 - in the tire pressure table on the inside of the fuel filler flap

Observe the notes on recommended tire pressures under various operating conditions (▷ page 318).

Check tire pressures regularly, and only when the tires are cold. Comply with the maintenance recommendations of the tire manufacturer in the vehicle document wallet.

- i** Notes on the vehicle equipment – always equip the vehicle with:
 - tires of the same size on a given axle (left/right)
 - the same type of tires at a given time (summer tires, winter tires, MOExtended tires)
- i** On the following pages, you can find information on approved wheel rims and tire sizes for equipping your vehicle with winter tires. Winter tires are not available at the factory as standard equipment or optional extras.

If you would like to equip your vehicle with approved winter tires, you may also, in certain circumstances, require rims of the appropriate size. The size of the approved winter tires may deviate from that of the standard tires. This is dependent on the model and the equipment installed at the factory.

The tires and wheel rims, as well as further information, can be obtained at a qualified specialist workshop.

- i** Overview of abbreviations used in the following tire tables:
 - BA: both axles
 - FA: front axle
 - RA: rear axle

In the following table, the wheel/tire combinations are assigned to the vehicle models through variants, e.g. V1, V2 etc.:

V1	C 250
V2	C 300, C 300 4MATIC
V3	C 350, C 350 4MATIC
V4	C 63 AMG

- i** Not all wheel and tire combinations are available at the factory for all countries.







Tires						
	Summer tires	Alloy wheels	V1	V2	V3	V4
BA	225/45 R17 91 W MOExtended ^{13, 14}	7.5 J x 17 H2 Wheel offset: 1.85 in (47 mm)	•	•	•	—
FA	225/45 R17 91 W MOExtended ¹³	7.5 J x 17 H2 Wheel offset: 1.85 in (47 mm)	•	•	•	—
RA	245/40 R17 91 W MOExtended ^{13, 15}	8.5 J x 17 H2 Wheel offset: 2.28 in (58 mm)				
FA	225/40 R18 92 Y XL	7.5 J x 18 H2 Wheel offset: 1.85 in (47 mm)	•	•	•	—
RA	255/35 R18 94 Y XL ¹⁵	8.5 J x 18 H2 Wheel offset: 2.13 in (54 mm)				
FA	225/40 R18 92 Y XL	8.0 J x 18 H2 Wheel offset: 1.97 in (50 mm)	•	•	•	—
RA	255/35 R18 94 Y XL ¹⁵	8.5 J x 18 H2 Wheel offset: 2.13 in (54 mm)				
FA	225/40 ZR18 92 Y XL	8.0 J x 18 H2 Wheel offset: 1.97 in (50 mm)	•	•	•	—
RA	255/35 ZR18 94 Y XL ¹⁵	8.5 J x 18 H2 Wheel offset: 2.13 in (54 mm)				
FA	235/40 ZR18 95 Y XL	8.0 J x 18 H2 Wheel offset: 1.77 in (45 mm)	—	—	—	•
RA	255/35 ZR18 94 Y XL ¹⁵	9.0 J x 18 H2 Wheel offset: 2.13 in (54 mm)				
FA	235/35 ZR19 XL	8.0 J x 19 H2 Wheel offset: 1.77 in (45 mm)	—	—	—	•
RA	255/30 ZR19 XL ¹⁵	9.0 J x 19 H2 Wheel offset: 2.13 in (54 mm)				

¹³ MOExtended tires (tires with run-flat characteristics) only in conjunction with an activated tire pressure loss warning system or tire pressure monitor.

¹⁴ Not in conjunction with sports suspension code 486, dynamic handling package code 483 and Sports package code 950/952.

¹⁵ Use of snow chains is not permitted. Observe the notes in the "Snow chains" section.

	All-weather tires	Alloy wheels	V1	V2	V3	V4
BA	205/55 R16 91 H M+S ¹⁶	7.0 J x 16 H2 Wheel offset: 1.69 in (43 mm)	•	–	–	–
BA	225/45 R17 91 H M+S ¹⁴	7.5 J x 17 H2 Wheel offset: 1.85 in (47 mm)	•	•	–	–
FA	225/45 R17 91 H M+S	7.5 J x 17 H2 Wheel offset: 1.85 in (47 mm)	•	•	•	–
RA	245/40 R17 91 H M+S ¹⁵	8.5 J x 17 H2 Wheel offset: 2.28 in (58 mm)				

	Winter tires	Alloy wheels	V1	V2	V3	V4
BA	205/55 R16 91 H M+S  ¹⁶	7.0 J x 16 H2 Wheel offset: 1.69 in (43 mm)	•	–	–	–
BA	225/45 R17 91 H M+S 	7.5 J x 17 H2 Wheel offset: 1.85 in (47 mm)	•	•	•	–
BA	225/45 R17 91 H M+S  MOExtended ¹³	7.5 J x 17 H2 Wheel offset: 1.85 in (47 mm)	•	•	•	–
BA	225/40 R18 92 V XL M+S 	8.0 J x 18 H2 Wheel offset: 1.77 in (45 mm)	–	–	–	•
BA	235/40 R18 95 V XL M+S  ¹⁵	8.0 J x 18 H2 Wheel offset: 1.77 in (45 mm)	–	–	–	•
FA	235/40 R18 95 V XL M+S 	8.0 J x 18 H2 Wheel offset: 1.77 in (45 mm)	–	–	–	•
RA	255/35 R18 94 V XL M+S  ¹⁵	9.0 J x 18 H2 Wheel offset: 2.13 in (54 mm)				

Wheels and tires

¹⁶ C 300 4MATIC: not in conjunction with Sports package code 950/952.

¹⁴ Not in conjunction with sports suspension code 486, dynamic handling package code 483 and Sports package code 950/952.

¹⁵ Use of snow chains is not permitted. Observe the notes in the "Snow chains" section.

¹³ MOExtended tires (tires with run-flat characteristics) only in conjunction with an activated tire pressure loss warning system or tire pressure monitor.

Emergency spare wheel

Important safety notes

WARNING

The wheel or tire size as well as the tire type of the spare wheel or emergency spare wheel and the wheel to be replaced may differ. Mounting an emergency spare wheel may severely impair the driving characteristics. There is a risk of an accident.

To avoid hazardous situations:

- adapt your driving style accordingly and drive carefully.
- never mount more than one spare wheel or emergency spare wheel that differs in size.
- only use a spare wheel or emergency spare wheel of a different size briefly.
- do not switch ESP® off.
- have a spare wheel or emergency spare wheel of a different size replaced at the nearest qualified specialist workshop. Observe that the wheel and tire dimensions as well as the tire type must be correct.

When using an emergency spare wheel or spare wheel of a different size, you must not exceed the maximum speed of 50 mph (80 km/h).

Snow chains must not be mounted on emergency spare wheels.

General notes

You should regularly check the pressure of the emergency spare wheel, particularly prior to long trips, and correct the pressure as necessary (▷ page 318). The applicable value is found on the wheel or under "Technical data" (▷ page 342).

- i** When you are driving with the collapsible spare wheel mounted, the tire pressure loss warning system or the tire pressure monitor cannot function reliably. Only restart the tire pressure loss warning system/the tire pressure monitor when the

damaged wheel has been replaced with a new wheel.

Vehicles with tire pressure monitor:

after mounting an emergency spare wheel, the system may still display the tire pressure of the removed wheel for a few minutes. The value displayed for the mounted emergency spare wheel is not the same as the current tire pressure of the emergency spare wheel.

An emergency spare wheel may also be mounted against the direction of rotation. Observe the time restriction on use as well as the speed limitation specified on the emergency spare wheel.

Replace the tires after six years at the latest, regardless of wear. This also applies to the emergency spare wheel.

"Minispare" emergency spare wheel

The "Minispare" emergency spare wheel can be found in the stowage well under the trunk floor.

- ▶ Lift the trunk floor upwards (▷ page 266).

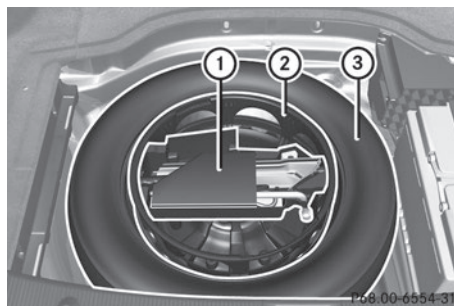

- ▶ Remove tool kit tray ①.
- ▶ Turn stowage tray ② counter-clockwise and remove it.
- ▶ Remove "Minispare" emergency spare wheel ③.

Always observe the instructions and safety notes in the "Mounting a wheel" section (▷ page 338).

Technical data					
"Minispare" emergency spare wheel ¹⁷					
Tires	Wheels	V1	V2	V3	V4
T 125/90 R16 98 M ¹⁸ Tire pressure: 420 kPa (4.2 bar/ 61 psi)	3.5 B x 16 H2 Wheel offset: 0.79 in (20 mm)	•	–	–	–
T 125/80 R17 99 M ¹⁹ Tire pressure: 420 kPa (4.2 bar/ 61 psi)	3.5 B x 17 H2 Wheel offset: 0.79 in (20 mm)	–	•	•	–
T 125/70 R18 99 M Tire pressure: 420 kPa (4.2 bar/ 61 psi)	3.5 B x 18 H2 Wheel offset: 0.79 in (20 mm)	–	–	–	•

i The specified tire pressure is printed in yellow on the emergency spare wheel.

¹⁷ Use of snow chains not permitted. Observe the notes in the section on snow chains.

¹⁸ C 300 4MATIC: Not in combination with Sports package code 950/952.

¹⁹ C 300 4MATIC: only in combination with Sports package code 950/952.

Useful information	350
Information regarding technical data	350
Warranty	350
Identification plates	350
Service products and filling capacities	351
Vehicle data	358

Useful information

- i** This Operator's Manual describes all models and all standard and optional equipment of your vehicle available at the time of publication of the Operator's Manual. Country-specific differences are possible. Please note that your vehicle may not be equipped with all features described. This also applies to safety-related systems and functions.
- i** Read the information on qualified specialist workshops: (> page 25).

Information regarding technical data

General information

- i** The data stated here specifically refers to a vehicle with standard equipment. Consult an authorized Mercedes-Benz Center for the data for all vehicle variants and trim levels.

Technical data

Warranty

Your vehicle is covered under the terms of the warranties printed in the Service and Warranty Information booklet.

Your authorized Mercedes-Benz Center will exchange or repair any defective parts originally installed in the vehicle in accordance with the terms of the following warranties:

- New Vehicle Limited Warranty
- Emission Systems Warranty
- Emission Performance Warranty
- California, Connecticut, Maine, Massachusetts, New York, Pennsylvania, Rhode Island and Vermont Emission Control System Warranty
- State warranty enforcement laws (Lemon Laws)

Replacement parts and accessories are covered by the Mercedes-Benz Parts and Accessories warranties. These are available at any authorized Mercedes-Benz Center.

- i** If you lose the Service and Warranty Information booklet, contact an authorized Mercedes-Benz Center to arrange a replacement. It will be mailed to you.

Identification plates

Vehicle identification plate with vehicle identification number (VIN)

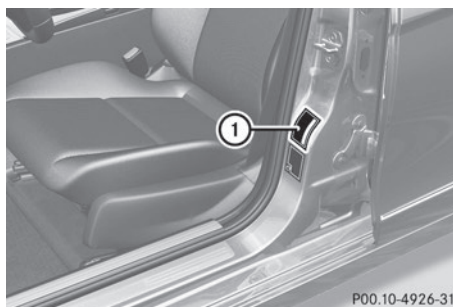

- ▶ Open the driver's door.
You will see vehicle identification plate ①.

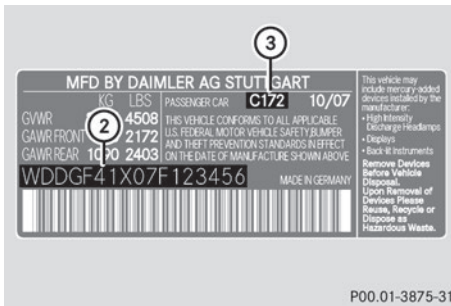

Example: vehicle identification plate (USA only)

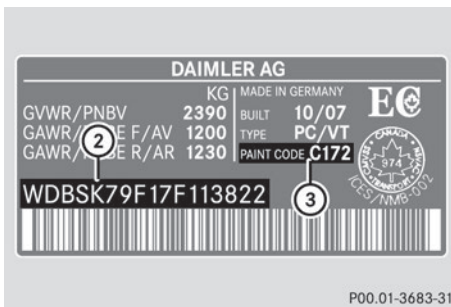

Example: vehicle identification plate (Canada only)

② VIN

③ Paint code

i The data shown on the identification plate is example data. This data is different for every vehicle and can deviate from the data shown here. You can find the data applicable to your vehicle on the vehicle identification plate.

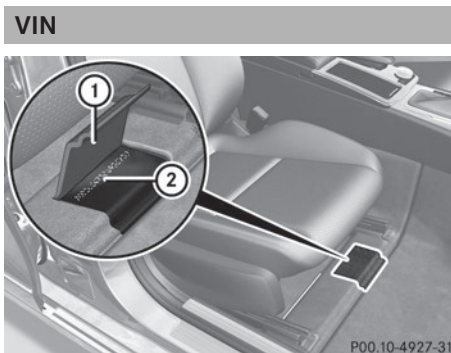

► Slide the right-hand front seat to its rearmost position.

► Fold floor covering ① upwards. You will see VIN ②.

The VIN can also be found in the following locations:

- on the lower edge of the windshield (▷ page 351)
- on the vehicle identification plate (▷ page 350)

Engine number

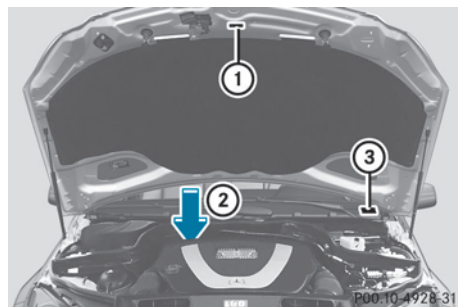

- ① Emission control information plate, including the certification of both federal and Californian emissions standards
- ② Engine number (stamped into the crankcase)
- ③ VIN (on the lower edge of the windshield)

Service products and filling capacities

Important safety notes

⚠ WARNING

Service products may be poisonous and hazardous to health. There is a risk of injury. Comply with instructions on the use, storage and disposal of service products on the labels of the respective original containers. Always store service products sealed in their original containers. Always keep service products out of the reach of children.

**Environmental note**

Dispose of service products in an environmentally responsible manner.

Service products include the following:

- Fuels
- Lubricants (e.g. engine oil, transmission oil)
- Coolant
- Brake fluid
- Windshield washer fluid
- Climate control system refrigerant

Comply with all valid regulations with respect to handling, storing, and disposing of service fluids.

Components and service products must be matched. You should therefore only use products that have been tested and approved by Mercedes-Benz.

Information about tested and approved products can be obtained from an authorized Mercedes-Benz Center or on the Internet at <http://bevo.mercedes-benz.com>.

You can recognize service products approved by Mercedes-Benz by the following inscription on the containers:

- MB-Freigabe (e.g. MB-Freigabe 229.51)
- MB Approval (e.g. MB Approval 229.51)

Other designations or recommendations indicate a level of quality or a specification in accordance with an MB Sheet number (e.g. MB 229.5). They have not necessarily been approved by Mercedes-Benz.

Fuel**Important safety notes****WARNING**

Fuel is highly flammable. If you handle fuel incorrectly, there is a risk of fire and explosion.

You must avoid fire, open flames, creating sparks and smoking. Switch off the engine

and, if applicable, the auxiliary heating before refueling.

**WARNING**

Fuel is poisonous and hazardous to health. There is a risk of injury.

You must make sure that fuel does not come into contact with your skin, eyes or clothing and that it is not swallowed. Do not inhale fuel vapors. Keep fuel away from children.

If you or others come into contact with fuel, observe the following:

- Wash away fuel from skin immediately using soap and water.
- If fuel comes into contact with your eyes, immediately rinse them thoroughly with clean water. Seek medical assistance without delay.
- If fuel is swallowed, seek medical assistance without delay. Do not induce vomiting.
- Immediately change out of clothing which has come into contact with fuel.

Tank capacity

Model	Total capacity
All models	17.4 US gal (66.0 l)

Model	Of which reserve
C 63 AMG	Approx. 3.7 US gal (14.0 l)
All other models	Approx. 2.1 US gal (8.0 l)

Gasoline

Fuel grade

! Do not use diesel to refuel vehicles with a gasoline engine. Do not switch on the ignition if you accidentally refuel with the wrong fuel. Otherwise, the fuel will enter the fuel system. Even small amounts of the wrong fuel could result in damage to the fuel system and the engine. Notify a qualified specialist workshop and have the fuel tank and fuel lines drained completely.

! Only refuel using unleaded gasoline with a minimum octane rating of 91.

! Only use the fuel recommended. Operating the vehicle with other fuels can lead to engine failure.

! Do not use the following:

- E85 (gasoline with 85% ethanol)
- E100 (100% ethanol)
- M15 (gasoline with 15% methanol)
- M30 (gasoline with 30% methanol)
- M85 (gasoline with 85% methanol)
- M100 (100% methanol)
- Gasoline with metalliferous additives
- Diesel

Do not mix such fuels with the fuel recommended for your vehicle. Do not use additives. This can otherwise lead to engine damage. This does not include cleaning additives for the removal and prevention of residue build-up. Gasoline may only be mixed with cleaning additives recommended by Mercedes-Benz; see "Additives". You can obtain further information from any authorized Mercedes-Benz Center.

! To ensure the longevity and full performance of the engine, only premium-grade unleaded gasoline must be used.

If standard premium-grade unleaded gasoline is unavailable and unleaded gasoline of a lower grade is used for refueling, observe the following precautions:

- only fill the fuel tank to half full with regular unleaded gasoline and fill the rest with premium-grade unleaded gasoline as soon as possible.
- do not drive at the maximum speed.
- avoid sudden acceleration and engine speeds above 3000 rpm.
- never refuel using fuel with an octane number lower than 87. Otherwise, engine failure could occur.

Using mixtures of methanol and ethanol is not permitted. E10 fuel or E15 fuel (unleaded gasoline with 10% or 15% ethanol) can be used.

You will usually find information about the fuel grade on the pump. If you cannot find the label on the pump, ask the staff for assistance.

i For further information, consult a qualified specialist workshop or on the Internet at <http://www.mbusa.com> (USA only).

Information on refueling (▷ page 162).

AMG vehicles

Additives

! Operating the engine with fuel additives added later can lead to engine failure. Do not mix fuel additives with fuel. This does not include additives for the removal and prevention of residue buildup. Gasoline must only be mixed with additives recommended by Mercedes-Benz. Comply with the instructions for use on the product label. More information about recommended additives can be obtained from any authorized Mercedes-Benz Center.

Mercedes-Benz recommends that you use fuel brands that have the additives.

The quality of the fuel available in some countries may not be sufficient. Residue could build up as a result. In such cases, and in consultation with an authorized Mercedes-Benz Center, the gasoline may be mixed with the cleaning additive recommended by Mercedes-Benz (part no. A000989254512). You must observe the notes and mixing ratios specified on the container.

Flexible Fuel vehicles

Important safety notes

WARNING

Fuel is highly flammable. If you handle fuel incorrectly, there is a risk of fire and explosion.

You must avoid fire, open flames, creating sparks and smoking. Switch off the engine and, if applicable, the auxiliary heating before refueling.

WARNING

Fuel is poisonous and hazardous to health. There is a risk of injury.

You must make sure that fuel does not come into contact with your skin, eyes or clothing and that it is not swallowed. Do not inhale fuel vapors. Keep fuel away from children.

If you or others come into contact with fuel, observe the following:

- Wash away fuel from skin immediately using soap and water.
- If fuel comes into contact with your eyes, immediately rinse them thoroughly with clean water. Seek medical assistance without delay.
- If fuel is swallowed, seek medical assistance without delay. Do not induce vomiting.
- Immediately change out of clothing which has come into contact with fuel.

Flexible Fuel vehicles can be refueled with the following fuel types:

- premium-grade unleaded gasoline
- E85 fuel
- a mixture of E85 fuel and premium-grade unleaded gasoline

 Flexible Fuel vehicles can be recognized by the **Ethanol up to E85** sticker on the inside of the fuel filler flap.

Fuel consumption

The energy content of E85 fuel is less than that of the same amount of premium-grade gasoline. The amount of fuel consumed when operating the vehicle with E85 fuel is therefore higher than with premium-grade gasoline.

Maintenance

Inform your authorized Mercedes-Benz Center that you are operating or have operated the vehicle with E85 fuel.

Low outside temperatures

If the outside temperature is below 32 °F (0 °C), the starting procedure can take noticeably longer when operating with E85 fuel.

E85 fuel is not suitable for use at outside temperatures under -4 °F (-20 °C).

Engine oil

General notes

 Never use engine oil or an oil filter of a specification other than is necessary to fulfill the prescribed service intervals. Do not change the engine oil or oil filter in order to achieve longer replacement intervals than those prescribed. You could otherwise cause engine damage or damage to the exhaust gas aftertreatment.

Follow the instructions in the service interval display regarding the oil change.

Otherwise, you may damage the engine and the exhaust gas aftertreatment.

When handling engine oil, observe the important safety notes on service products (▷ page 351).

The engine oils are matched to the performance of Mercedes-Benz engines and service intervals. You should therefore only use engine oils and oil filters that are approved for vehicles with maintenance systems.

For a list of approved engine oils and oil filters, consult an authorized Mercedes-Benz Center. Or visit the website <http://bevo.mercedes-benz.com>.

The table shows which engine oils have been approved for your vehicle.

Model	Engine model	MB Approval
C 250	271	229.5
C 300 (Canada only)	276	229.5
C 300 4MATIC	272	229.5
C 350 C 350 4MATIC (Canada only)	276	229.5
C 63 AMG	156	229.5

Use only SAE 0W-40 or SAE 5W-40 engine oils for AMG vehicles.

- i** MB approval is indicated on the oil containers.

Filling capacities

The following values refer to an oil change including the oil filter.

Model	Capacity
C 250	5.8 US qt (5.5 l)
C 63 AMG	With external oil cooler: 9.0 US qt (8.5 l)
All other models	6.9 US qt (6.5 l)

Additives

- !** Do not use any additives in the engine oil. This could damage the engine.

Engine oil viscosity

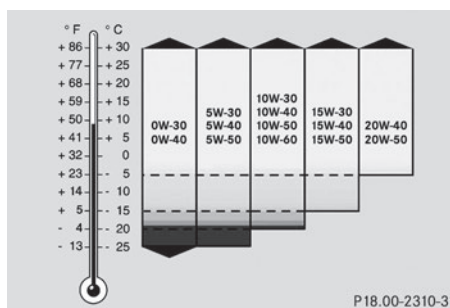

Viscosity describes the flow characteristics of a fluid. If an engine oil has a high viscosity, this means that it is thick; a low viscosity means that it is thin.

Select an engine oil with an SAE classification (viscosity) suitable for the prevailing outside temperatures. The table shows you which SAE classifications are to be used. The low-temperature characteristics of engine oils can deteriorate significantly, e.g. as a result of aging, soot and fuel deposits. It is therefore strongly recommended that you carry out regular oil changes using an approved engine oil with the appropriate SAE classification.

Brake fluid

⚠ WARNING

The brake fluid constantly absorbs moisture from the air. This lowers the boiling point of

the brake fluid. If the boiling point of the brake fluid is too low, vapor pockets may form in the brake system when the brakes are applied hard. This would impair braking efficiency. There is a risk of an accident.

You should have the brake fluid renewed at the specified intervals.

When handling brake fluid, observe the important safety notes on service products (▷ page 351).

The brake fluid change intervals can be found in the Maintenance Booklet.

Only use brake fluid approved by Mercedes-Benz according to MB Approval 331.0.

Information about approved brake fluid can be obtained at any qualified specialist workshop or on the Internet at <http://bevo.mercedes-benz.com>.

- i** Have the brake fluid regularly replaced at a qualified specialist workshop and the replacement confirmed in the Maintenance Booklet.

Coolant

Important safety notes

WARNING

If antifreeze comes into contact with hot components in the engine compartment, it may ignite. There is a risk of fire and injury.

Let the engine cool down before you add antifreeze. Make sure that antifreeze is not spilled next to the filler neck. Thoroughly clean the antifreeze from components before starting the engine.

- !** Only add coolant that has been premixed with the desired antifreeze protection. You could otherwise damage the engine. Further information on coolants can be found in the Mercedes-Benz Specifications for Service Products, MB Specifications for Service Products 310.1, e.g. on the Internet at

<http://bevo.mercedes-benz.com>. Or contact a qualified specialist workshop.

- !** Always use a suitable coolant mixture, even in countries where high temperatures prevail.

Otherwise, the engine cooling system is not sufficiently protected from corrosion and overheating.

- i** Have the coolant regularly replaced at a qualified specialist workshop and the replacement confirmed in the Maintenance Booklet.

Comply with the important safety precautions for service products when handling coolant (▷ page 351).

The coolant is a mixture of water and antifreeze/corrosion inhibitor. It performs the following tasks:

- corrosion protection
- antifreeze protection
- raising the boiling point

If the coolant has antifreeze protection down to -35 °F (-37 °C), the boiling point of the coolant during operation is approximately 266 °F (130 °C).

The antifreeze/corrosion inhibitor concentration in the engine cooling system should:

- be at least 50%. This will protect the engine cooling system against freezing down to approximately -35 °F (-37 °C).
- not exceed 55% (antifreeze protection down to -49 °F [-45 °C]). Otherwise, heat will not be dissipated as effectively.

If the vehicle has lost coolant, add equal amounts of water and antifreeze/corrosion inhibitor.

Mercedes-Benz recommends an antifreeze/corrosion inhibitor concentrate in accordance with MB Specifications for Service Products 310.1.

- i** When the vehicle is first delivered, it is filled with a coolant mixture that ensures

adequate antifreeze and corrosion protection.

- i** The coolant is checked with every maintenance interval at a qualified specialist workshop.

Filling capacities

Model	Capacity
C 250	Approx. 8.1 US qt (7.7 l)
C 350 4MATIC (Canada only)	Approx. 8.9 US qt (8.4 l)
C 63 AMG	Approx. 12.4 US qt (11.7 l)
All other models	Approx. 10.1 US gal (9.6 l)

- i** Use MB 325.0 or MB 326.0 corrosion inhibitor/antifreeze.

Windshield washer system

Important safety notes

WARNING

Windshield washer concentrate is highly flammable. If it comes into contact with hot engine components or the exhaust system it could ignite. There is a risk of fire and injury.

Make sure that no windshield washer concentrate is spilled next to the filler neck.

- !** Only use washer fluid that is suitable for plastic lamp lenses, e.g. MB SummerFit or MB WinterFit. Unsuitable washer fluid could damage the plastic lenses of the headlamps.
- !** Do not add distilled or de-ionized water to the washer fluid container. Otherwise, the level sensor may be damaged.
- !** Only MB SummerFit and MB WinterFit washer fluid should be mixed together. The

spray nozzles may otherwise become blocked.

When handling washer fluid, observe the important safety notes on service products (> page 351).

At temperatures above freezing:

- ▶ Fill the washer fluid reservoir with a mixture of water and windshield washer fluid, e.g. MB SummerFit.
- ▶ Add 1 part MB SummerFit to 100 parts water.

At temperatures below freezing:

- ▶ Fill the washer fluid reservoir with a mixture of water and washer fluid, e.g. MB WinterFit.

Adapt the mixing ratio to the outside temperature.

- Down to 14 °F (-10 °C): mix 1 part MB WinterFit to 2 parts water.
- Down to -4 °F (-20 °C): mix 1 part MB WinterFit to 1 part water.
- Down to -20.2 °F (-29 °C): mix 2 parts MB WinterFit to 1 part water.

- i** Add windshield washer fluid, e.g. MB SummerFit or MB WinterFit, to the washer fluid all year round.

Climate control system refrigerant

Important safety notes

The climate control system of your vehicle is filled with refrigerant R-134a.

The instruction label regarding the refrigerant type used can be found on the radiator cross member.

- !** Only the refrigerant R-134a and the PAG oil approved by Mercedes-Benz may be used. The approved PAG oil may not be mixed with any other PAG oil that is not approved for R-134a refrigerant. Otherwise, the climate control system may be damaged.

Service work, such as topping-up refrigerant or replacing components, may only be carried out by a qualified specialist workshop. All applicable regulations must be adhered to, SAE standard J639 included.

Always have work on the climate control system carried out at a qualified specialist workshop.

Refrigerant instruction label

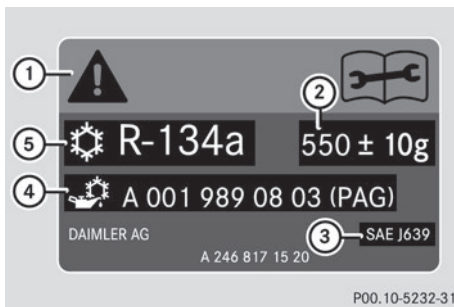

Example: refrigerant instruction label

- ① Warning symbol
- ② Refrigerant filling capacity
- ③ Applicable SAE standards
- ④ PAG oil part number
- ⑤ Type of refrigerant

Warning symbols ① indicate:

- possible dangers
- that it is necessary to have maintenance work carried out at a qualified specialist workshop

Filling capacities

Missing values were not available at time of going to print.

All models	Capacity
Refrigerant	20.8 ± 0.4 oz (590 ± 10 g)
PAG oil	4.2 oz (120 g)

Vehicle data

General notes

Please note that for the specified vehicle data:

- the heights specified may vary as a result of:
 - tires
 - load
 - condition of the suspension
 - optional equipment
- optional equipment reduces the maximum payload.

Dimensions and weights

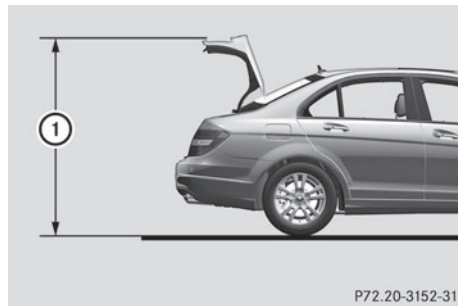

Model	① Opening height
All models	69.2 in (1757 mm)

Missing values were not available at time of going to print.

All models (except for AMG vehicles)	
Vehicle length	180.7 in (4591 mm)
Vehicle width including exterior mirrors	79.1 in (2008 mm)
Vehicle height	56.9 in (1444 mm)
Wheelbase	108.7 in (2760 mm)

All models (except for AMG vehicles)	
Turning radius	35.6 ft (10.84 m)
Maximum roof load	max. 220 lb (100 kg)
Maximum trunk load	max. 220 lb (100 kg)

C 63 AMG	
Vehicle length	185.1 in (4702 mm)
Vehicle width including exterior mirrors	79.1 in (2008 mm)
Vehicle height	56.4 in (1433 mm)
Wheelbase	108.9 in (2765 mm)
Turning radius	36.4 ft (11.10 m)
Maximum roof load	max. 220 lb (100 kg)
Maximum trunk load	max. 220 lb (100 kg)



2045843383

Order no. 6515079413 Part no. 2045843383 Edition A 2014