



B-Class

Operator's Manual



Mercedes-Benz

Symbols

Registered trademarks:

- Bluetooth® is a registered trademark of Bluetooth SIG Inc.
- DTS is a registered trademark of DTS, Inc.
- Dolby and MLP are registered trademarks of DOLBY Laboratories.
- BabySmart™, ESP® and PRE-SAFE® are registered trademarks of Daimler AG.
- HomeLink® is a registered trademark of Johnson Controls.
- iPod® and iTunes® are registered trademarks of Apple Inc.
- Logic7® is a registered trademark of Harman International Industries.
- Microsoft® and Windows media® are registered trademarks of Microsoft Corporation.
- SIRIUS is a registered trademark of Sirius XM Radio Inc.
- HD Radio is a registered trademark of iBiquity Digital Corporation.
- Gracenote® is a registered trademark of Gracenote, Inc.
- ZAGATSurvey® and related brands are registered trademarks of ZagatSurvey, LLC.

In this Operator's Manual you will find the following symbols:

WARNING

Warning notes make you aware dangers which could pose a threat to your health or life, or to the health and life of others.

Environmental note

Environmental notes provide you with information on environmentally aware actions or disposal.

- ! Notes on material damage alert you to dangers that could lead to damage to your vehicle.

- i Practical tips or further information that could be helpful to you.

▶ This symbol indicates an instruction that must be followed.

▶ Several of these symbols in succession indicate an instruction with several steps.

(▷ page) This symbol tells you where you can find more information about a topic.

▷▷ This symbol indicates a warning or an instruction that is continued on the next page.

Display This font indicates a display in the multifunction display/COMAND display.

Parts of the software in the vehicle are protected by copyright © 2005 The FreeType Project <http://www.freetype.org>. All rights reserved.

Welcome to the world of Mercedes-Benz

We urge you to read this Operator's Manual carefully and familiarize yourself with the vehicle before driving. For your own safety and a longer vehicle life, follow the instructions and warning notices in this manual. Ignoring them could result in damage to the vehicle or personal injury to you or others.

Vehicle damage caused by failure to follow instructions is not covered by the Mercedes-Benz Limited Warranty.

The equipment or product designation of your vehicle may vary depending on:

- Model
- Order
- Country specification
- Availability

Mercedes-Benz therefore reserves the right to introduce changes in the following areas:

- Design
- Equipment
- Technical features

The equipment in your vehicle may therefore differ from that shown in the descriptions and illustrations.

The following are integral components of the vehicle:

- Operator's Manual
- Maintenance Booklet
- Equipment-dependent supplements

Keep printed copies of the documents in the vehicle at all times. If you sell the vehicle, always pass the documents on to the new owner.

The technical documentation team at Daimler AG wishes you safe and pleasant motoring.

Mercedes-Benz USA, LLC
Mercedes-Benz Canada, Inc.
A Daimler Company

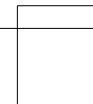
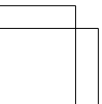
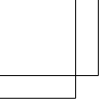

Index	4	At a glance	29
Introduction	21	Safety	39
		Opening and closing	73
		Seats, steering wheel and mirrors	91
		Lights and windshield wipers	103
		Climate control	121
		Driving and parking	135
		On-board computer and displays	189
		Stowage and features	249
		Maintenance and care	279
		Breakdown assistance	293
		Wheels and tires	311
		Technical data	345

1, 2, 3 ...

12 V socket

see Sockets

A**ABS (Anti-lock Braking System)**

Display message 208

Function/notes 63

Important safety notes 63

Warning lamp 239

Activating/deactivating cooling**with air dehumidification** 126**Active Parking Assist**

Canceling 179

Detecting parking spaces 176

Display message 228

Exiting a parking space 178

Function/notes 175

Important safety notes 175

Parking 177

ADAPTIVE BRAKE 69**Adaptive Brake Assist**

Display message 216

Function/notes 65

Adaptive brake lamps 67**Adaptive Highbeam Assist**

Display message 223

Function/notes 108

Switching on/off 109

Switching on/off (on-board

computer) 203

Additional speedometer 202**Additives (engine oil)** 350**Air bags**

Deployment 41

Display message 219

Front air bag (driver, front

passenger) 45

Important safety notes 43

Knee bag 45

PASSENGER AIR BAG OFF

indicator lamp 47

Safety guidelines 42

Side impact air bag 46

Window curtain air bag 47

Air-conditioning system

see Climate control

Air vents

Important safety notes 133

Rear 134

Setting 133

Setting the center air vents 133

Setting the side air vents 133

Alarm system

see ATA (Anti-Theft Alarm system)

Ambient lighting

Setting the brightness (on-board

computer) 204

Anti-lock braking system

see ABS (Anti-lock Braking System)

Anti-theft alarm system

see ATA (Anti-Theft Alarm system)

Ashtray 263**Assistance display (on-board****computer)** 199**Assistance menu (on-board****computer)** 199**ASSYST PLUS**

Displaying a service message 285

Hiding a service message 285

Notes 284

Resetting the service interval

display 285

Service message 284

Special service requirements 285

ATA (Anti-Theft Alarm system)

Activating/deactivating 70

Function 70

Switching off the alarm 70

ATTENTION ASSIST

Activating/deactivating 201

Display message 226

Function/notes 183

Audio menu (on-board computer) 196**Audio system**

see separate operating instructions

Authorized Centers

see Qualified specialist workshop

Authorized Mercedes-Benz Center

see Qualified specialist workshop

Authorized workshops

see Qualified specialist workshop

- AUTO lights**
 Display message 223
 see Lights
- Automatic engine start (ECO start/stop function)** 140
- Automatic engine switch-off (ECO start/stop function)** 139
- Automatic headlamp mode** 105
- Automatic transmission**
 Automatic drive program 147
 Changing gear 146
 DIRECT SELECT lever 143
 Display message 233
 Drive program display 144
 Driving tips 146
 Emergency running mode 150
 Engaging drive position 145
 Engaging neutral 144
 Engaging reverse gear 144
 Engaging the park position 144
 Holding the vehicle stationary on uphill gradients 146
 Kickdown 146
 Manual drive program 147
 Overview 143
 Problem (malfunction) 150
 Program selector button 146
 Pulling away 138
 Starting the engine 137
 Steering wheel paddle shifters 147
 Transmission position display 144
 Transmission positions 145
- Automatic transmission emergency mode** 150
- B**
- Backup lamp**
 Changing bulbs 115
 Display message 222
- Bag hook** 257
- BAS (Brake Assist System)** 64
- Battery (SmartKey)**
 Checking 76
 Important safety notes 76
 Replacing 76
- Battery (vehicle)**
 Charging 302
 Display message 225
 Important safety notes 299
 Jump starting 303
- Belt force limiter**
 Activation 55
 Function 55
- Blind Spot Assist**
 Activating/deactivating 201
 Display message 227
 Notes/function 184
- Brake Assist**
 see BAS (Brake Assist System)
- Brake fluid**
 Display message 214
 Notes 350
- Brake lamps**
 Adaptive 67
 Changing bulbs 115
 Display message 221
- Brakes**
 ABS 63
 Adaptive Brake Assist 65
 BAS 64
 Brake fluid (notes) 350
 Display message 208
 Driving tips 157
 Important safety notes 157
 Maintenance 158
 Parking brake 153
 Warning lamp 239
- Breakdown**
 see Flat tire
 see Towing away/tow-starting
- Bulbs**
 see Replacing bulbs
- C**
- Calling up a malfunction**
 see Display messages
- Car**
 see Vehicle
- Care**
 Carpets 291
 Car wash 286
 Display 290

- Exhaust pipe 290
- Exterior lights 289
- Gear or selector lever 290
- Interior 290
- Matte finish 288
- Notes 285
- Paint 287
- Plastic trim 290
- Power washer 287
- Rear view camera 289
- Roof lining 291
- Seat belt 291
- Seat cover 291
- Sensors 289
- Steering wheel 290
- Trim pieces 290
- Washing by hand 286
- Wheels 287
- Windows 288
- Wiper blades 288
- Wooden trim 290
- Cargo compartment cover** 258
- Cargo compartment enlargement** ... 254
 - Important safety notes 254
 - Notes on use 256
- Cargo compartment floor**
 - Height adjustment 260
 - Important safety notes 259
 - Opening/closing 259
 - Stowage well (under) 259
- Cargo net**
 - Attaching 259
 - Important safety information 259
- Cargo tie down rings** 257
- Car wash (care)** 286
- Center console**
 - Lower section 35
 - Upper section 34
- Central locking**
 - Automatic locking (on-board computer) 205
 - Locking/unlocking (SmartKey) 74
- Changing bulbs**
 - Brake lamps 115
 - Cornering light function 114
 - High-beam headlamps 113
 - License plate lighting 117
 - Low-beam headlamps 113
 - Parking lamps 113
 - Rear fog lamp 115
 - Reversing lamps 115
 - Standing lamps (front) 113
 - Tail lamps 115
 - Turn signals (front) 114
 - Turn signals (rear) 115
- Child-proof locks**
 - Important safety notes 61
 - Rear doors 62
- Children**
 - In the vehicle 56
 - Restraint systems 56
- Child seat**
 - LATCH-type (ISOFIX) child seat anchors 60
 - On the front-passenger seat 59
 - Top Tether 60
- Cigarette lighter** 264
- Climate control**
 - Automatic climate control 123
 - Automatic climate control (dual-zone) 125
 - Controlling automatically 128
 - Cooling with air dehumidification . . 126
 - Defrosting the windows 130
 - Defrosting the windshield 130
 - Important safety notes 122
 - Indicator lamp 128
 - Notes on using automatic climate control 125
 - Notes on using dual-zone automatic climate control 123
 - Overview of systems 122
 - Problems with cooling with air dehumidification 128
 - Problem with the rear window defroster 132
 - Refrigerant 352
 - Refrigerant filling capacity 353
 - Setting the air distribution 129
 - Setting the airflow 129
 - Setting the air vents 133
 - Setting the temperature 128
 - Switching air-recirculation mode on/off 132
 - Switching on/off 126
 - Switching residual heat on/off 132

- Switching the rear window defroster on/off 130
- Switching the ZONE function on/off 129
- Cockpit**
 - Overview 30
 - see Instrument cluster
- COLLISION PREVENTION ASSIST**
 - Activating/deactivating the distance warning function 200
 - Display message 208
 - Operation/notes 64
- COLLISION PREVENTION ASSIST PLUS**
 - Activating/deactivating 201
 - Display message 215
 - Operation/notes 66
- COMAND**
 - see separate operating instructions
- Combination switch** 106
- Compass**
 - Calibrating 277
 - Calling up 276
 - Setting 276
- Consumption statistics (on-board computer)** 194
- Convenience closing feature** 84
- Convenience opening feature** 84
- Coolant (engine)**
 - Checking the level 283
 - Display message 224
 - Filling capacity 352
 - Important safety notes 351
 - Temperature gauge 190
 - Warning lamp 245
- Cooling**
 - see Climate control
- Copyright** 27
- Cornering light function**
 - Changing bulbs 114
 - Display message 220
 - Function/notes 107
- Crash-responsive emergency lighting** 110
- Cruise control**
 - Activation conditions 161
 - Cruise control lever 161
 - Deactivating 162
 - Display message 230
 - Driving system 160
 - Function/notes 160
 - Important safety notes 161
 - Setting a speed 162
 - Storing and maintaining current speed 161
- Cup holder**
 - Center console 262
 - Important safety notes 261
 - Rear compartment 262
- Customer Assistance Center (CAC)** ... 25
- Customer Relations Department** 25

D

Dashboard

see Instrument cluster

Dashboard lighting

see Instrument cluster lighting

Data

see Technical data

Daytime running lamps

- Display message 223
- Switching on/off (on-board computer) 203
- Switching on/off (switch) 105

Dealerships

see Qualified specialist workshop

Declarations of conformity 24

Delayed switch-off

- Exterior lighting (on-board computer) 204
- Interior lighting 204

Diagnostics connection 24

Digital speedometer 195

DIRECT SELECT lever

see Automatic transmission

Display (cleaning instructions) 290

Display messages

- ASSYST PLUS 284
- Calling up (on-board computer) 207
- Driving systems 226
- Engine 224
- General notes 207
- Hiding (on-board computer) 207
- Lights 220

- Safety systems 208
- SmartKey 237
- Tires 231
- Vehicle 233
- Distance display (on-board computer)** 199
- Distance recorder** 193
 - see Odometer
 - see Trip odometer
- Distance warning function**
 - Activating/deactivating 200
 - Function/notes 64
 - Warning lamp 247
- DISTRONIC PLUS**
 - Activation conditions 164
 - Cruise control lever 164
 - Deactivating 167
 - Display message 228
 - Displays in the multifunction display 168
 - Driving tips 170
 - Function/notes 162
 - Important safety notes 163
 - Setting the specified minimum distance 167
 - Warning lamp 247
- Doors**
 - Automatic locking (on-board computer) 205
 - Automatic locking (switch) 80
 - Central locking/unlocking (SmartKey) 74
 - Control panel 37
 - Display message 235
 - Emergency locking 81
 - Emergency unlocking 81
 - Important safety notes 79
 - Opening (from inside) 79
- Drinking and driving** 155
- Drinks holder**
 - see Cup holder
- Drive program**
 - Automatic 147
 - Display (DIRECT SELECT lever) 144
 - Manual 147
- Driver's door**
 - see Doors
- Driving abroad**
 - Mercedes-Benz Service 285
 - Symmetrical low beam 104
- Driving on flooded roads** 159
- Driving safety systems**
 - ABS (Anti-lock Braking System) 63
 - ADAPTIVE BRAKE 69
 - Adaptive Brake Assist 65
 - Adaptive brake lamps 67
 - BAS (Brake Assist System) 64
 - COLLISION PREVENTION ASSIST 64
 - COLLISION PREVENTION ASSIST PLUS 66
 - Distance warning function 64
 - Electronic brake force distribution ... 69
 - ESP® (Electronic Stability Program) 67, 68
 - ETS (Electronic Traction System) 67
 - Important safety information 63
 - Overview 63
 - STEER CONTROL 70
- Driving systems**
 - Active Parking Assist 175
 - ATTENTION ASSIST 183
 - Blind Spot Assist 184
 - Cruise control 160
 - Display message 226
 - DISTRONIC PLUS 162
 - HOLD function 171
 - Lane Keeping Assist 186
 - Lane Tracking package 184
 - PARKTRONIC 172
 - Rear view camera 179
- Driving tips**
 - Automatic transmission 146
 - Brakes 157
 - Break-in period 136
 - Checking brake lining thickness 158
 - DISTRONIC PLUS 170
 - Downhill gradient 157
 - Drinking and driving 155
 - Driving abroad 104
 - Driving in winter 160
 - Driving on flooded roads 159
 - Driving on wet roads 159
 - Exhaust check 155
 - Fuel 155
 - General 155

- Hydroplaning 159
 - Icy road surfaces 160
 - Limited braking efficiency on
 - salted roads 157
 - Snow chains 315
 - Symmetrical low beam 104
 - Wet road surface 157
 - DVD audio (on-board computer)** 197
 - DVD video (on-board computer)** 197
- E**
- EASY-VARIO-PLUS system**
 - Cargo compartment enlargement .. 254
 - EBD (electronic brake force distribution)**
 - Display message 210
 - Function/notes 69
 - ECO display**
 - Function/notes 156
 - On-board computer 194
 - ECO start/stop function**
 - Automatic engine start 140
 - Automatic engine switch-off 139
 - Deactivating/activating 140
 - General information 139
 - Important safety notes 139
 - Introduction 138
 - Electronic Stability Program**
 - see ESP® (Electronic Stability Program)
 - Emergency release**
 - Driver's door 81
 - Vehicle 81
 - Emergency spare wheel**
 - General notes 342
 - Important safety notes 342
 - Removing 343
 - Technical data 343
 - Emergency Tensioning Devices**
 - Activation 41
 - Function 55
 - Safety guidelines 42
 - Emergency unlocking**
 - Tailgate 82
 - Emissions control**
 - Service and warranty information 22
- Engine**
 - Check Engine warning lamp 245
 - Display message 224
 - ECO start/stop function 138
 - Engine number 347
 - Irregular running 142
 - Jump-starting 303
 - Starting problems 142
 - Starting the engine with the
 - SmartKey 138
 - Switching off 153
 - Tow-starting (vehicle) 308
 - Engine electronics**
 - Problem (malfunction) 142
 - Engine oil**
 - Adding 282
 - Additives 350
 - Checking the oil level 281
 - Checking the oil level using the
 - dipstick 282
 - Display message 225
 - Filling capacity 350
 - Notes about oil grades 349
 - Notes on oil level/consumption 281
 - Viscosity 350
 - ESP® (Electronic Stability Program)**
 - Deactivating/activating 200
 - Deactivating/activating (notes) 68
 - Display message 208
 - ETS 67
 - Function/notes 67, 68
 - General notes 67
 - Important safety information 68
 - Warning lamp 241
 - ETS (Electronic Traction System)** 67
 - Exhaust check** 155
 - Exhaust pipe (cleaning instructions)** 290
 - Exterior lighting**
 - Setting options 104
 - see Lights
 - Exterior mirrors**
 - Adjusting 99
 - Dipping (automatic) 100
 - Folding in/out (automatically) 100
 - Folding in/out (electrically) 99

Folding in when locking (on-board computer)	206
Out of position (troubleshooting) ...	100
Setting	100
Storing settings (memory function)	101
Storing the parking position	100
Eyeglasses compartment	251

F

Filler cap

see Fuel filler flap

First-aid kit	294
----------------------------	-----

Flat tire

MOExtended tires	295
Preparing the vehicle	295
TIREFIT kit	296
see Emergency spare wheel	

Floormats	277
------------------------	-----

Fog lamps

Extended range	108
Switching on/off	105

Folding table	253
----------------------------	-----

Front fog lamps

Display message	222
Switching on/off	105

Front-passenger seat

Folding the backrest forward/back	253
-----------------------------------	-----

Fuel

Additives	349
Consumption statistics	194
Displaying the current consumption	194
Displaying the range	194
Driving tips	155
Fuel gauge	31
Grade (gasoline)	348
Important safety notes	348
Premium-grade unleaded gasoline .	348
Problem (malfunction)	152
Refueling	150
Tank content/reserve fuel	348

Fuel filler flap

Opening/closing	151
-----------------------	-----

Fuel level

Calling up the range (on-board computer)	194
--	-----

Fuel tank

Capacity	348
Problem (malfunction)	152

Fuses

Allocation chart	309
Before changing	308
Fuse box in the engine compartment	308
Fuse box in the front-passenger footwell	309
Important safety notes	308

G

Garage door opener

Clearing the memory	276
Important safety notes	273
Opening/closing the garage door ..	276
Programming (button in the rear-view mirror)	274

Gear or selector lever (cleaning

guidelines)	290
-------------------	-----

Genuine parts	21
----------------------------	----

Glove box	251
------------------------	-----

H

Handbrake

see Parking brake

Hazard warning lamps	107
-----------------------------------	-----

Display message	236
-----------------------	-----

Headlamps

Fogging up	109
see Automatic headlamp mode	

Head restraints

Adjusting	95
Adjusting (electrically)	96
Adjusting (manually)	95
Adjusting (rear)	96
Installing/removing (rear)	96

Heating

see Climate control

High-beam headlamps

Changing bulbs	113
Display message	221
Switching on/off	106

Hill start assist	138
--------------------------------	-----

HOLD function	
Deactivating	172
Display message	226
Function/notes	171
Hood	
Closing	281
Display message	235
Important safety notes	280
Opening	280
Hydroplaning	159

I

Ignition lock	
see Key positions	
Immobilizer	70
Indicator lamps	
see Warning and indicator lamps	
Instrument cluster	
Overview	31
Settings	202
Warning and indicator lamps	32
Instrument cluster lighting	190
Interior lighting	109
Automatic control	110
Delayed switch-off (on-board computer)	204
Emergency lighting	110
Manual control	110
Overview	109
Reading lamp	109
Setting the brightness of the ambient lighting (on-board computer)	204

J

Jack	
Storage location	294
Using	337
Jump starting (engine)	303

K

Kickdown	
Driving tips	146
Manual drive program	149
Knee bag	45

L

Lamps	
see Warning and indicator lamps	
Lane Keeping Assist	
Activating/deactivating	201
Display message	227
Function/information	186
Lane Tracking package	184
LATCH-type (ISOFIX) child seat anchors	60
License plate lamp	
Changing bulbs	117
License plate lamp (display message)	221
Light function, active	
Display message	223
Lighting	
Light switch	104
Lights	
Activating/deactivating the interior lighting delayed switch-off .	204
Automatic headlamp mode	105
Cornering light function	107
Display message	220
Driving abroad	104
Fog lamps	105
Fog lamps (extended)	108
Hazard warning lamps	107
High beam flasher	107
High-beam headlamps	106
Low-beam headlamps	105
Parking lamps	106
Rear fog lamp	106
Setting the brightness of the ambient lighting (on-board computer)	204
Standing lamps	106
Switching Adaptive Highbeam Assist on/off	203
Switching the daytime running lamps on/off (on-board computer)	203
Switching the daytime running lamps on/off (switch)	105
Switching the exterior lighting delayed switch-off on/off (on- board computer)	204

- Switching the surround lighting
 - on/off (on-board computer) 204
 - Turn signals 106
 - see Interior lighting
 - see Replacing bulbs
 - Light sensor (display message)** 223
 - Loading guidelines** 250
 - Locking**
 - see Central locking
 - Locking (doors)**
 - Automatic 80
 - Emergency locking 81
 - From inside (central locking button) 80
 - Locking centrally**
 - see Central locking
 - Locking verification signal (on-board computer)** 205
 - Low-beam headlights**
 - Changing bulbs 113
 - Display message 220
 - Setting for driving abroad (symmetrical) 104
 - Switching on/off 105
 - Lumbar support**
 - Adjusting the 4-way lumbar support 96
- M**
- M+S tires** 314
 - Malfunction message**
 - see Display messages
 - Matte finish (cleaning instructions)** 288
 - mbrace**
 - Call priority 269
 - Display message 214
 - Downloading destinations (COMAND) 269
 - Downloading routes 272
 - Emergency call 266
 - General notes 265
 - Geo fencing 273
 - Locating a stolen vehicle 271
 - MB info call button 268
 - Remote vehicle locking 271
 - Roadside Assistance button 267
 - Search & Send 270
 - Self-test 266
 - Speed alert 273
 - System 266
 - Triggering the vehicle alarm 273
 - Vehicle remote malfunction diagnosis 271
 - Vehicle remote unlocking 270
 - Mechanical key**
 - Function/notes 75
 - Locking vehicle 81
 - Unlocking the driver's door 81
 - Memory card (audio)** 197
 - Memory function** 101
 - Message memory (on-board computer)** 207
 - Messages**
 - see Display messages
 - Mirrors**
 - see Exterior mirrors
 - see Rear-view mirror
 - see Vanity mirror (in the sun visor)
 - Mobile phone**
 - Menu (on-board computer) 197
 - Modifying the programming (SmartKey)** 75
 - MOExtended tires** 295
 - Mounting wheels**
 - Lowering the vehicle 339
 - Mounting a new wheel 339
 - Preparing the vehicle 337
 - Raising the vehicle 337
 - Removing a wheel 339
 - Securing the vehicle against rolling away 337
 - MP3**
 - Operation 197
 - see separate operating instructions
 - Multifunction display**
 - Function/notes 192
 - Permanent display 203
 - Multifunction steering wheel**
 - Operating the on-board computer . 191
 - Overview 33

N**Navigation**

- Menu (on-board computer) 195
- see separate operating instructions

- Notes on breaking-in a new vehicle** 136

O**Occupant Classification System (OCS)**

- Faults 51
- Operation 47
- System self-test 50

Occupant safety

- Children in the vehicle 56
- Important safety notes 40

OCS

- Faults 51
- Operation 47
- System self-test 50

Oil

- see Engine oil

On-board computer

- Assistance menu 199
- Audio menu 196
- Convenience submenu 206
- Displaying a service message 285
- Display messages 207
- DISTRONIC PLUS 168
- Factory settings submenu 206
- Important safety notes 190
- Instrument cluster submenu 202
- Lighting submenu 203
- Menu overview 193
- Message memory 207
- Navigation menu 195
- Operation 191
- Service menu 202
- Settings menu 202
- Standard display 193
- Telephone menu 197
- Trip menu 193
- Vehicle submenu 205
- Video DVD operation 197

- Opening and closing the side trim panels** 114

Operating safety

- Declaration of conformity 24
- Important safety notes 23

Operating system

- see On-board computer

Operator's Manual

- Vehicle equipment 22

- Outside temperature display** 191

- Overhead control panel** 36

Override feature

- Rear side windows 62

P

- Paint code number** 346

- Paintwork (cleaning instructions)** ... 287

- Panic alarm** 40

Panorama roof with power tilt/sliding panel

- Opening/closing the roller
- sunblind 88
- Problem (malfunction) 88
- Resetting 88

Panorama sliding sunroof

- Important safety notes 86

- Parcel net** 253

- Parking** 152

- Important safety notes 152
- Parking brake 153
- Position of exterior mirror, front-passenger side 100
- Rear view camera 179
- see Active Parking Assist
- see PARKTRONIC

Parking aid

- Active Parking Assist 175
- see Exterior mirrors
- see PARKTRONIC

Parking brake

- Display message 211
- Electric parking brake 153
- Warning lamp 244

Parking lamps

- Switching on/off 106

- Parking lamps (changing bulbs)** 113

PARKTRONIC

- Deactivating/activating 174
- Driving system 172

- Function/notes 172
 - Important safety notes 172
 - Problem (malfunction) 175
 - Range of the sensors 173
 - Warning display 173
 - PASSENGER AIR BAG OFF**
 - Problems (malfunction) 219
 - PASSENGER AIR BAG OFF indicator lamp** 47
 - Plastic trim (cleaning instructions)** . 290
 - Power washers** 287
 - Power windows**
 - see Side windows
 - Program selector button** 146
 - Protection of the environment**
 - General notes 21
 - Pulling away**
 - Automatic transmission 138
- Q**
- Qualified specialist workshop** 25
- R**
- Radar sensor system**
 - Activating/deactivating 205
 - Display message 226
 - Radio**
 - Selecting a station 196
 - see separate operating instructions
 - Radio-wave reception/transmission in the vehicle**
 - Declaration of conformity 24
 - Reading lamp** 109
 - Rear compartment**
 - Setting the air vents 134
 - Rear fog lamp**
 - Changing bulbs 115
 - Display message 222
 - Switching on/off 106
 - Rear lamps**
 - Changing bulbs 115
 - see Lights
 - Rear seat**
 - Adjusting the angle of the backrests 256
 - Folding the backrest forwards/back (vehicles without the EASY-VARIO-PLUS system) 254
 - Folding the backrest forwards/back (vehicles with the EASY-VARIO-PLUS system) 255
 - Fore-and-aft adjustment 257
 - Rear view camera**
 - Cleaning instructions 289
 - Function/notes 179
 - Switching on/off 180
 - Rear-view mirror**
 - Anti-glare (manual) 99
 - Dipping (automatic) 100
 - Rear window defroster**
 - Problem (malfunction) 132
 - Switching on/off 131
 - Rear window wiper**
 - Replacing the wiper blade 119
 - Switching on/off 118
 - Refrigerant (air-conditioning system)**
 - Important safety notes 352
 - Refueling**
 - Fuel gauge 31
 - Important safety notes 150
 - Refueling process 151
 - see Fuel
 - Remote control**
 - Garage door opener 273
 - Programming (garage door opener) 274
 - Replacing bulbs**
 - Important safety notes 110
 - Overview of bulb types 111
 - Removing/replacing the cover (front wheel arch) 112
 - Reporting safety defects** 25
 - Reserve (fuel tank)**
 - see Fuel
 - Reserve fuel**
 - Display message 225
 - Warning lamp 245
 - see Fuel
 - Residual heat (climate control)** 132

- Restraint system**
 - see SRS (Supplemental Restraint System)
 - Reversing feature**
 - Panorama sliding sunroof 86
 - Roller sunblinds 87
 - Side windows 83
 - Roadside Assistance (breakdown)** 23
 - Roller sunblind**
 - Opening/closing 88
 - Panorama roof with power tilt/
sliding panel 87
 - Roof carrier** 261
 - Roof lining and carpets (cleaning guidelines)** 291
 - Roof load (maximum)** 353
 - Route (navigation)**
 - see Route guidance (navigation)
 - Route guidance (navigation)** 195
- S**
- Safety**
 - Children in the vehicle 56
 - Child restraint systems 56
 - Occupant Classification System (OCS) 47
 - Safety system**
 - see Driving safety systems
 - Seat**
 - Folding the backrest (rear compartment) forwards/back (vehicles without the EASY-VARIO-PLUS system) 254
 - Folding the backrest (rear compartment) forwards/back (vehicles with the EASY-VARIO-PLUS system) 255
 - Seat belts**
 - Adjusting the height 54
 - Belt force limiters 55
 - center rear-compartment seat 54
 - Cleaning 291
 - Correct usage 52
 - Emergency Tensioning Devices 55
 - Fastening 53
 - Important safety guidelines 52
 - Releasing 54
 - Safety guidelines 42
 - Warning lamp 237
 - Warning lamp (function) 55
 - Seats**
 - Adjusting (electrically) 95
 - Adjusting (manually) 94
 - Adjusting the 4-way lumbar support 96
 - Adjusting the head restraint 95
 - Cleaning the cover 291
 - Correct driver's seat position 92
 - Important safety notes 93
 - Seat heating problem 98
 - Storing settings (memory function) 101
 - Switching seat heating on/off 97
 - Sensors (cleaning instructions)** 289
 - Service menu (on-board computer)** . 202
 - Service products**
 - Brake fluid 350
 - Coolant (engine) 351
 - Engine oil 349
 - Fuel 348
 - Important safety notes 347
 - Refrigerant (air-conditioning system) 352
 - Washer fluid 352
 - Service work**
 - see ASSYST PLUS
 - Settings**
 - Factory (on-board computer) 206
 - On-board computer 202
 - Setting the air distribution** 129
 - Setting the airflow** 129
 - Side impact air bag** 46
 - Side marker lamp (display message)** 222
 - Side windows**
 - Cleaning 288
 - Convenience closing feature 84
 - Convenience opening feature 84
 - Important safety information 83
 - Opening/closing 83
 - Problem (malfunction) 85
 - Resetting 85
 - Sliding sunroof**
 - see Panorama roof with power tilt/sliding panel

- SmartKey**
 - Changing the battery 76
 - Changing the programming 75
 - Checking the battery 76
 - Convenience closing feature 84
 - Convenience opening feature 84
 - Display message 237
 - Door central locking/unlocking 74
 - Important safety notes 74
 - Loss 78
 - Mechanical key 75
 - Positions (ignition lock) 137
 - Problem (malfunction) 78
 - Starting the engine 138
 - SmartKey positions (ignition lock) ..** 137
 - Snow chains** 315
 - Sockets**
 - Center console 264
 - Luggage compartment 265
 - Points to observe before use 264
 - Rear compartment 265
 - Specialist workshop** 25
 - Speed, controlling**
 - see Cruise control
 - Speedometer**
 - Activating/deactivating the additional speedometer 202
 - Digital 195
 - In the Instrument cluster 31
 - Segments 191
 - Selecting the unit of measurement see Instrument cluster 202
 - SRS**
 - see SRS (Supplemental Restraint System)
 - SRS (Supplemental Restraint System)**
 - Display message 216
 - Introduction 40
 - Warning lamp 244
 - Warning lamp (function) 41
 - Standing lamps**
 - Changing bulbs 113
 - Display message 222
 - Switching on/off 106
 - Start/stop function**
 - see ECO start/stop function
 - Starting (engine)** 137
 - Status overview (on-board computer)** 199
 - STEER CONTROL** 70
 - Steering (display message)** 236
 - Steering wheel**
 - Adjusting (manually) 98
 - Button overview 33
 - Buttons (on-board computer) 191
 - Cleaning 290
 - Important safety notes 98
 - Paddle shifters 147
 - Steering wheel paddle shifters** 147
 - Stowage areas** 251
 - Stowage compartments**
 - Armrest (front) 252
 - Armrest (under) 252
 - Center console 251
 - Cup holders 261
 - Eyeglasses compartment 251
 - Glove box 251
 - Important safety information 251
 - Parcel net 253
 - Under driver's seat/front-passenger seat 252
 - Stowage space**
 - Center console (rear) 252
 - Summer tires** 314
 - Sun visor** 263
 - Surround lighting (on-board computer)** 204
 - Switching air-recirculation mode on/off** 132
 - Switching off the alarm (ATA)** 70
- T**
- Tachometer** 191
 - Tailgate**
 - Display message 235
 - Emergency unlocking 82
 - Important safety notes 81
 - Opening/closing (from outside) 82
 - Opening dimensions 353
 - Tail lamps**
 - Display message 221
 - see Lights
 - Tank content**
 - Fuel gauge 31

- Technical data**
 - Capacities 347
 - Emergency spare wheel 343
 - Information 346
 - Tires/wheels 340
 - Vehicle data 353
- TELEAID**
 - Call priority 269
 - Downloading destinations (COMAND) 269
 - Downloading routes 272
 - Emergency call 266
 - Geo fencing 273
 - Locating a stolen vehicle 271
 - MB info call button 268
 - Remote vehicle locking 271
 - Roadside Assistance button 267
 - Search & Send 270
 - Self-test 266
 - Speed alert 273
 - System 266
 - Triggering the vehicle alarm 273
 - Vehicle remote malfunction diagnosis 271
 - Vehicle remote unlocking 270
- Tele Aid**
 - General notes 265
- Telephone**
 - Accepting a call 198
 - Display message 236
 - Menu (on-board computer) 197
 - Number from the phone book 198
 - Redialing 198
 - Rejecting/ending a call 198
- Temperature**
 - Coolant 190
 - Outside temperature 191
 - Setting (climate control) 128
- Theft deterrent systems**
 - ATA (Anti-Theft Alarm system) 70
 - Immobilizer 70
- Through-loading** 253
- Time**
 - see separate operating instructions
- TIREFIT kit** 296
- Tire pressure**
 - Calling up (on-board computer) 320
 - Checking manually 319
 - Display message 231
 - Important safety notes 320
 - Maximum 318
 - Notes 317
 - Not reached (TIREFIT) 298
 - Reached (TIREFIT) 298
 - Recommended 315
- Tire pressure loss warning system**
 - General notes 319
 - Important safety notes 319
 - Restarting 319
- Tire pressure monitoring system**
 - Checking the tire pressure electronically 322
 - Function/notes 320
 - General notes 320
 - Important safety notes 320
 - Restarting 322
 - Warning lamp 248
 - Warning message 322
- Tires**
 - Aspect ratio (definition) 335
 - Average weight of the vehicle occupants (definition) 333
 - Bar (definition) 333
 - Changing a wheel 336
 - Characteristics 333
 - Checking 313
 - Definition of terms 333
 - Direction of rotation 336
 - Display message 231
 - Distribution of the vehicle occupants (definition) 335
 - DOT, Tire Identification Number (TIN) 332
 - DOT (Department of Transportation) (definition) 333
 - GAWR (Gross Axle Weight Rating) (definition) 334
 - GVW (Gross Vehicle Weight) (definition) 334
 - GVWR (Gross Vehicle Weight Rating) (definition) 334
 - Important safety notes 312
 - Increased vehicle weight due to optional equipment (definition) 333
 - Kilopascal (kPa) (definition) 334

- Labeling (overview) 329
 - Load bearing index (definition) 335
 - Load index 332
 - Load index (definition) 334
 - M+S tires 314
 - Maximum loaded vehicle weight
(definition) 334
 - Maximum load on a tire (definition) 334
 - Maximum permissible tire
pressure (definition) 334
 - Maximum tire load 327
 - Maximum tire load (definition) 334
 - MOExtended tires 314
 - Optional equipment weight
(definition) 335
 - PSI (pounds per square inch)
(definition) 334
 - Replacing 336
 - Service life 314
 - Sidewall (definition) 335
 - Speed rating (definition) 334
 - Storing 336
 - Structure and characteristics
(definition) 333
 - Summer tires 160, 314
 - Temperature 329
 - TIN (Tire Identification Number)
(definition) 335
 - Tire bead (definition) 335
 - Tire pressure (definition) 335
 - Tire pressures (recommended) 333
 - Tire size (data) 340
 - Tire size designation, load-bearing
capacity, speed rating 330
 - Tire tread 313
 - Tire tread (definition) 335
 - Total load limit (definition) 335
 - Traction 328
 - Traction (definition) 335
 - Tread wear 328
 - Uniform Tire Quality Grading
Standards 328
 - Uniform Tire Quality Grading
Standards (definition) 333
 - Unladen weight (definition) 334
 - Wear indicator (definition) 335
 - Wheel rim (definition) 333
 - see Flat tire
 - Top Tether** 60
 - Towing**
 - Important safety guidelines 305
 - Installing the towing eye 306
 - Removing the towing eye 306
 - Towing away**
 - With both axles on the ground 307
 - With front axle raised 307
 - Tow-starting**
 - Emergency engine starting 308
 - Important safety notes 305
 - Installing the towing eye 306
 - Removing the towing eye 306
 - Transmission**
 - see Automatic transmission
 - Transmission position display** 144
 - Transporting the vehicle** 307
 - Trim pieces (cleaning instructions)** . 290
 - Trip computer (on-board computer)** 194
 - Trip odometer**
 - Calling up 193
 - Resetting (on-board computer) 195
 - Trunk**
 - see Tailgate
 - Turn signals**
 - Changing bulbs (front) 114
 - Changing bulbs (rear) 115
 - Display message 220
 - Switching on/off 106
 - Type identification plate**
 - see Vehicle identification plate
- ## U
- Unlocking**
 - Emergency unlocking 81
 - From inside the vehicle (central
unlocking button) 80
- ## V
- Vanity mirror (in the sun visor)** 263
 - Vehicle**
 - Correct use 25
 - Data acquisition 26
 - Equipment 22
 - Individual settings 202
 - Limited Warranty 26

- Loading 323
 - Locking (in an emergency) 81
 - Locking (SmartKey) 74
 - Lowering 339
 - Maintenance 22
 - Parking for a long period 155
 - Pulling away 138
 - Raising 337
 - Reporting problems 25
 - Securing from rolling away 337
 - Towing away 305
 - Tow-starting 305
 - Transporting 307
 - Unlocking (in an emergency) 81
 - Unlocking (SmartKey) 74
 - Vehicle data 353
 - Vehicle data** 353
 - Vehicle dimensions** 353
 - Vehicle emergency locking** 81
 - Vehicle identification number**
see VIN
 - Vehicle identification plate** 346
 - Vehicle tool kit** 294
 - Video (DVD)** 197
 - VIN** 346
- W**
- Warning and indicator lamps**
 - ABS 239
 - Brakes 239
 - Check Engine 245
 - Coolant 245
 - Distance warning 247
 - DISTRONIC PLUS 247
 - ESP® 241
 - ESP® OFF 242
 - Fuel tank 245
 - Overview 32
 - PASSENGER AIR BAG OFF
indicator lamp 47
 - Reserve fuel 245
 - Seat belt 237
 - SRS 244
 - Tire pressure monitor 248
 - Warranty** 346
 - Washer fluid**
 - Display message 236
 - Wheel bolt tightening torque** 339
 - Wheel chock** 337
 - Wheels**
 - Changing a wheel 336
 - Checking 313
 - Cleaning 287
 - Cleaning (warning) 336
 - Emergency spare wheel 342
 - Important safety notes 312
 - Interchanging/changing 336
 - Mounting a new wheel 339
 - Mounting a wheel 337
 - Removing a wheel 339
 - Storing 336
 - Tightening torque 339
 - Wheel size/tire size 340
 - Window curtain air bag**
 - Display message 217
 - Operation 47
 - Windows**
see Side windows
 - Windshield**
 - Defrosting 130
 - Windshield washer system**
 - Adding washer fluid 284
 - Notes 352
 - Windshield wipers**
 - Display message 236
 - Problem (malfunction) 120
 - Rear window wiper 118
 - Replacing the wiper blades 118
 - Switching on/off 117
 - Winter driving**
 - Slippery road surfaces 160
 - Snow chains 315
 - Winter operation**
 - General notes 314
 - Winter tires**
 - M+S tires 314
 - Wiper blades**
 - Cleaning 288
 - Important safety notes 118
 - Replacing (rear window) 119
 - Replacing (windshield) 118
 - Wooden trim (cleaning instructions)** 290
 - Workshops**
see Qualified specialist workshop

Z

ZONE function

Switching on/off 129

Protection of the environment

General notes

Environmental note

Daimler's declared policy is one of comprehensive environmental protection.

The objectives are for the natural resources that form the basis of our existence on this planet to be used sparingly and in a manner that takes the requirements of both nature and humanity into account.

You too can help to protect the environment by operating your vehicle in an environmentally responsible manner.

Fuel consumption and the rate of engine, transmission, brake and tire wear are affected by these factors:

- operating conditions of your vehicle
- your personal driving style

You can influence both factors. You should bear the following in mind:

Operating conditions:

- avoid short trips as these increase fuel consumption.
- always make sure that the tire pressures are correct.
- do not carry any unnecessary weight.
- remove roof racks once you no longer need them.
- a regularly serviced vehicle will contribute to environmental protection. You should therefore adhere to the service intervals.
- always have service work carried out at a qualified specialist workshop.

Personal driving style:

- do not depress the accelerator pedal when starting the engine.
- do not warm up the engine when the vehicle is stationary.
- drive carefully and maintain a safe distance from the vehicle in front.
- avoid frequent, sudden acceleration and braking.

- change gear in good time and use each gear only up to $\frac{2}{3}$ of its maximum engine speed.
- switch off the engine in stationary traffic.
- keep an eye on the vehicle's fuel consumption.

Environmental concerns and recommendations

Wherever the operating instructions require you to dispose of materials, first try to regenerate or re-use them. Observe the relevant environmental rules and regulations when disposing of materials. In this way you will help to protect the environment.

Genuine Mercedes-Benz parts

Environmental note

Daimler AG also supplies reconditioned major assemblies and parts which are of the same quality as new parts. They are covered by the same Limited Warranty entitlements as new parts.

! Air bags and Emergency Tensioning Devices, as well as control units and sensors for these restraint systems, may be installed in the following areas of your vehicle:

- doors
- door pillars
- door sills
- seats
- cockpit
- instrument cluster
- center console

Do not install accessories such as audio systems in these areas. Do not carry out repairs or welding. You could impair the operating efficiency of the restraint systems.

Have aftermarket accessories installed at a qualified specialist workshop.

You could jeopardize the operating safety of your vehicle if you use parts, tires and wheels as well as accessories relevant to safety which have not been approved by Mercedes. This could lead to malfunctions in safety-relevant systems, e.g. the brake system. Use only genuine Mercedes-Benz parts or parts of equal quality. Only use tires, wheels and accessories that have been specifically approved for your vehicle.

Genuine Mercedes-Benz parts are subject to strict quality control. Every part has been specifically developed, manufactured or selected for and adapted to Mercedes-Benz vehicles. Only genuine Mercedes-Benz parts should therefore be used.

More than 300,000 different genuine Mercedes-Benz parts are available for Mercedes-Benz models.

All authorized Mercedes-Benz Centers maintain a supply of genuine Mercedes-Benz parts for necessary service and repair work. In addition, strategically located parts delivery centers provide quick and reliable parts service.

Always specify the vehicle identification number (VIN) (▷ page 346) when ordering genuine Mercedes-Benz parts.

Operator's Manual

Vehicle equipment

This Operator's Manual describes all models and all standard and optional equipment of your vehicle available at the time of going to print. Country-specific differences are possible. Bear in mind that your vehicle may not feature all functions described here. This also applies to safety-relevant systems and functions. The equipment in your vehicle may therefore differ from that shown in the descriptions and illustrations.

The original purchase agreement lists all systems installed in your vehicle.

Should you have any questions concerning equipment and operation, please consult an authorized Mercedes-Benz Center.

The Operator's Manual and Maintenance Booklet are important documents and should be kept in the vehicle.

Service and vehicle operation

Service and literature

Your vehicle is covered under the terms of the warranties printed in the Service and Warranty Information booklet. Your authorized Mercedes-Benz Center will exchange or repair any defective parts originally installed in the vehicle in accordance with the terms of the following warranties:

- New Vehicle Limited Warranty
- Emission Systems Warranty
- Emission Performance Warranty
- California, Connecticut, Maine, Massachusetts, New York, Pennsylvania, Rhode Island and Vermont Emission Control Systems Warranty
- State warranty enforcement laws (lemon laws)

Maintenance

The Service and Warranty Booklet describes all the necessary maintenance work which should be done at regular intervals.

Always have the Service and Warranty Booklet with you when you bring the vehicle to an authorized Mercedes-Benz Center. The service advisor will record every service for you in the Service and Warranty Booklet.

Roadside Assistance

The Mercedes-Benz Roadside Assistance Program offers technical help in the event of a breakdown. Calls to the toll-free Roadside Assistance Hotline are answered by our agents 24 hours a day, 365 days a year.

**1-800-FOR-MERCEdes(1-800-367-6372)
(USA)**

1-800-387-0100 (Canada)

For additional information, refer to the Mercedes-Benz Roadside Assistance Program brochure (USA) or the "Roadside Assistance" section in the Service and Warranty booklet (Canada). You will find both in your vehicle literature portfolio.

Change of address or change of ownership

In the event of a change of address, please send us the "Notification of Address Change" in the Service and Guarantee booklet or simply call the Mercedes-Benz Customer Assistance Center (USA) at the hotline number

1-800-FOR-MERCEdes(1-800-367-6372) or Customer Service Center (Canada) at 1-800-387-0100. This will assist us in contacting you in a timely manner should the need arise.

If you sell your Mercedes, please leave the entire literature in the vehicle so that it is available to the next owner.

If you have purchased a used car, please send us the "Notification of Used Car Purchase" in the Service and Guarantee booklet or simply call the Mercedes-Benz Customer Assistance Center (USA) at the hotline number 1-800-FOR-MERCEdes(1-800-367-6372) or Customer Service (Canada) at 1-800-387-0100.

Vehicle operation outside Canada

If you plan to operate your vehicle in foreign countries, please be aware that:

- service facilities or replacement parts may not be readily available.
- unleaded fuel for vehicles with a catalytic converter may not be available. Leaded fuel may cause damage to the catalytic converter.
- the fuel may have a considerably lower octane rating. Unsuitable fuel can cause engine damage.

Some Mercedes-Benz models are available for delivery in Europe through our European Delivery Program. For details, consult an authorized Mercedes-Benz Center or write to one of the following addresses.

In the USA

Mercedes-Benz USA, LLC
European Delivery Department
One Mercedes Drive
Montvale, NJ 07645-0350

In Canada

Mercedes-Benz Canada, Inc.
European Delivery Department
98 Vanderhoof Avenue
Toronto, Ontario M4G 4C9

Operating safety

Important safety notes

WARNING

If you do not have the prescribed service/maintenance work or any required repairs carried out, this can result in malfunctions or system failures. There is a risk of an accident.

Always have the prescribed service/maintenance work as well as any required repairs carried out at a qualified specialist workshop.

⚠ WARNING

If you switch off the ignition while driving, safety-relevant functions are only available with limitations, or not at all. This could affect, for example, the power steering and the brake boosting effect. You will require considerably more effort to steer and brake. There is a risk of an accident.

Do not switch off the ignition while driving.

⚠ WARNING

Modifications to electronic components, their software as well as wiring can impair their function and/or the function of other networked components. In particular, systems relevant to safety could also be affected. As a result, these may no longer function as intended and/or jeopardize the operating safety of the vehicle. There is an increased risk of an accident and injury.

Never tamper with the wiring as well as electronic components or their software. You should have all work to electrical and electronic equipment carried out at a qualified specialist workshop.

! There is a risk of damage to the vehicle if:

- the vehicle becomes stuck, e.g. on a high curb or an unpaved road
- you drive too fast over an obstacle, e.g. a curb or a hole in the road
- a heavy object strikes the undercarriage or parts of the chassis

In situations like this, the body, the undercarriage, chassis parts, wheels or tires could be damaged without the damage being visible. Components damaged in this way can unexpectedly fail or, in the case of an accident, no longer withstand the strain they are designed to. If the underbody paneling is damaged, combustible materials such as leaves, grass or twigs can gather between the underbody and the underbody paneling. If these materials come in contact with hot

parts of the exhaust system for an extended period, they can catch fire.

In such cases, have the vehicle checked and repaired immediately at a qualified specialist workshop. If on continuing your journey you notice that driving safety is impaired, pull over and stop the vehicle immediately, paying attention to road and traffic conditions. In such cases, visit a qualified specialist workshop.

Declarations of conformity**Vehicle components which receive and/or transmit radio waves**

USA: "The wireless devices of this vehicle comply with Part 15 of the FCC Rules. Operation is subject to the following two conditions: 1) These devices may not cause harmful interference, and 2) These devices must accept any interference received, including interference that may cause undesired operation. Changes or modifications not expressly approved by the party responsible for compliance could void the user's authority to operate the equipment."

Canada: "The wireless devices of this vehicle comply with Industry Canada license-exempt RSS standard(s). Operation is subject to the following two conditions: (1) These devices may not cause interference, and (2) These devices must accept any interference, including interference that may cause undesired operation of the device."

Diagnostics connection

The diagnostics connection is only intended for the connection of diagnostic equipment at a qualified specialist workshop.

⚠ WARNING

If you connect equipment to the diagnostics connection in the vehicle, it may affect the operation of the vehicle systems. As a result,

the operating safety of the vehicle could be affected. There is a risk of an accident.

Do not connect any equipment to a diagnostics connection in the vehicle.

WARNING

Objects in the driver's footwell can restrict the pedal travel or obstruct a depressed pedal. The operating and road safety of the vehicle is jeopardized. There is a risk of an accident.

Make sure that all objects in the vehicle are stowed correctly, and that they cannot enter the driver's footwell. Install the floor mats securely and as specified in order to ensure sufficient clearance for the pedals. Do not use loose floor mats and do not place floor mats on top of one another.

 If the engine is switched off and equipment on the diagnostics connection is used, the starter battery may discharge.

Connecting equipment to the diagnostics connection can lead to emissions monitoring information being reset, for example. This may lead to the vehicle failing to meet the requirements of the next emissions test during the main inspection.

Qualified specialist workshop

An authorized Mercedes-Benz Center is a qualified specialist workshop. It has the necessary specialist knowledge, tools and qualifications to correctly carry out the work required on your vehicle. This is especially the case for work relevant to safety.

Observe the notes in the Maintenance Booklet.

Always have the following work carried out at an authorized Mercedes-Benz Center:

- work relevant to safety
- service and maintenance work
- repair work

- alterations, installation work and modifications
- work on electronic components

Correct use

If you remove any warning stickers, you or others could fail to recognize certain dangers. Leave warning stickers in position.

Observe the following information when driving your vehicle:

- the safety notes in this manual
- the Technical Data section in this manual
- traffic rules and regulations
- laws and safety standards pertaining to motor vehicles

Problems with your vehicle

If you should experience a problem with your vehicle, particularly one that you believe may affect its safe operation, we urge you to contact an authorized Mercedes-Benz Center immediately to have the problem diagnosed and rectified. If the problem is not resolved to your satisfaction, please discuss the problem again with a Mercedes-Benz Center or contact us at one of the following addresses.

In the USA

Customer Assistance Center
Mercedes-Benz USA, LLC
One Mercedes Drive
Montvale, NJ 07645-0350

In Canada

Customer Relations Department
Mercedes-Benz Canada, Inc.
98 Vanderhoof Avenue
Toronto, Ontario M4G 4C9

Reporting safety defects

USA only:

The following text is published as required of manufacturers under Title 49, Code of U.S. Federal Regulations, Part 575 pursuant to the "National Traffic and Motor Vehicle Safety Act of 1966".

If you believe that your vehicle has a defect which could cause a crash or could cause injury or death, you should immediately inform the National Highway Traffic Safety Administration (NHTSA) in addition to notifying Mercedes-Benz USA, LLC.

If NHTSA receives similar complaints, it may open an investigation, and if it finds that a safety defect exists in a group of vehicles, it may order a recall and remedy campaign. However, NHTSA cannot become involved in individual problems between you, your dealer, or Mercedes-Benz USA, LLC.

To contact NHTSA, you may call the Vehicle Safety Hotline toll-free at 1-888-327-4236 (TTY: 1-800-424-9153); go to <http://www.safercar.gov>; or write to: Administrator, NHTSA, 400 Seventh Street, SW., Washington, DC 20590.

You can also obtain other information about motor vehicle safety from <http://www.safercar.gov>

Limited Warranty

! Follow the instructions in this manual about the proper operation of your vehicle as well as about possible vehicle damage. Damage to your vehicle that arises from culpable contraventions against these instructions is not covered either by the Mercedes-Benz Limited Warranty or by the New or Used-Vehicle Warranty.

Data stored in the vehicle

Information about electronic data acquisition in the vehicle

(Including notice pursuant to California Code § 9951)

Please note that your vehicle is equipped with devices that can record vehicle systems data. If your vehicle is equipped with mbrace (Canada: TELE AID), data is transmitted in the event of an accident.

This information helps, for example, to test vehicle systems after an accident and to continually improve vehicle safety. Daimler AG can access these data and submit them:

- for safety research or vehicle diagnosis purposes
- with the consent of the vehicle owner
- on the instruction of prosecuting authorities
- for use in arbitration of disputes that involve Daimler AG, its subsidiaries or its sales and service organizations
- as otherwise required or permitted by law

Please check your mbrace (Canada: TELE AID) purchase agreement to find out more about data that can be recorded and transmitted by this system.

This vehicle is equipped with an event data recorder (EDR). The main purpose of an EDR is to record data that will assist in understanding how a vehicle's systems performed in certain crash or near crash-like situations, such as during air bag deployment or when hitting a road obstacle. The EDR is designed to record data related to vehicle dynamics and safety systems for a short period of time, typically 30 seconds or less. The EDR in this vehicle is designed to record such data as:

- how various systems in your vehicle are operating
- whether or not the driver and passenger seat belts are fastened
- how far (if at all) the driver is depressing the accelerator and/or brake pedal and
- how fast the vehicle is traveling

This data can help provide a better understanding of the circumstances in which crashes and injuries occur. NOTE: EDR data

is recorded by your vehicle only if a non-trivial crash situation occurs; no data is recorded by the EDR under normal driving conditions and no personal data (e.g., name, gender, age, and crash location) are recorded. However, other parties, such as law enforcement, can combine the EDR data with the type of personal identification data routinely acquired during a crash investigation.

To read data recorded by an EDR, special equipment is required, and access to the vehicle or the EDR is needed. In addition to the vehicle manufacturer, other parties, such as law enforcement, who have the special equipment, can read the information if they have access to the vehicle or the EDR.

Information on copyright

General information

Information on license for free and open-source software used in your vehicle and its electronic components is available on the following website:

<http://www.mercedes-benz.com/opensource>

Dashboard 30
Instrument cluster 31
Multifunction steering wheel 33
Center console 34
Overhead control panel 36
Door control panel 37



Dashboard

At a glance



	Function	Page
①	Steering wheel paddle shifters	147
②	Combination switch	106
③	Instrument cluster	31
④	Horn	
⑤	DIRECT SELECT lever	143
⑥	PARKTRONIC warning display	172
⑦	Overhead control panel	36
⑧	Climate control systems	122

	Function	Page
⑨	Ignition lock	137
⑩	Adjusting the steering wheel	98
⑪	Cruise control lever	161
⑫	Electric parking brake	153
⑬	Light switch	104
⑭	Diagnostics connection	24
⑮	Opening the hood	280

Instrument cluster

Displays and controls



At a glance

Function	Page	Function	Page
① Speedometer with segments	191	④ Coolant temperature	190
② Multifunction display	192	⑤ Fuel gauge	
③ Tachometer	191	⑥ Instrument cluster lighting	190

Warning and indicator lamps



P54.33-2656-31







	Function	Page
①	Low-beam headlamps	105
②	Parking lamps	106
③	High-beam headlamps	106
④	ESP®	241
⑤	Electric parking brake (red)	244
⑥	Electric parking brake (yellow)	244
⑦	Distance warning	247
⑧	Turn signals	106
⑨	SRS	244







	Function	Page
⑩	Seat belt	237
⑪	Coolant	245
⑫	Rear fog lamp	106
⑬	Front fog lamps	105
⑭	Check Engine	245
⑮	Tire pressure monitor	248
⑯	Reserve fuel	245
⑰	ESP® OFF	241
⑱	ABS	239
⑲	Brakes	239

Multifunction steering wheel



At a glance

	Function	Page
①	Multifunction display	192
②	Audio/COMAND display; see the separate operating instructions	
③	 Switches on the Voice Control System; see the separate operating instructions	
④	 Rejects or ends a call Exits phone book/redial memory  Makes or accepts a call Switches to the redial memory   Adjusts the volume  Mute	197

	Function	Page
⑤	  Selects a menu   Selects a submenu or scrolls through lists  Confirms your selection Hides display messages	191
⑥	 Back Switches off the Voice Control System; see the separate operating instructions	191



P46.10-3181-31

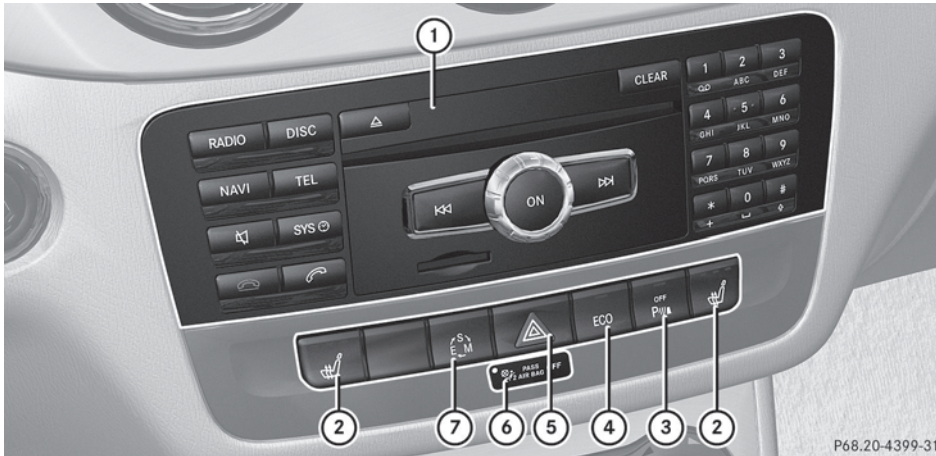

Center console

Center console, upper section

At a glance



	Function	Page
①	Audio system/COMAND; see the separate operating instructions	
②	 Seat heating	97
③	 PARKTRONIC	172
④	 ECO start/stop function	139

	Function	Page
⑤	 Hazard warning lamps	107
⑥	 PASSENGER AIR BAG OFF indicator lamp	47
⑦	 Selects the drive program	146

Center console, lower section

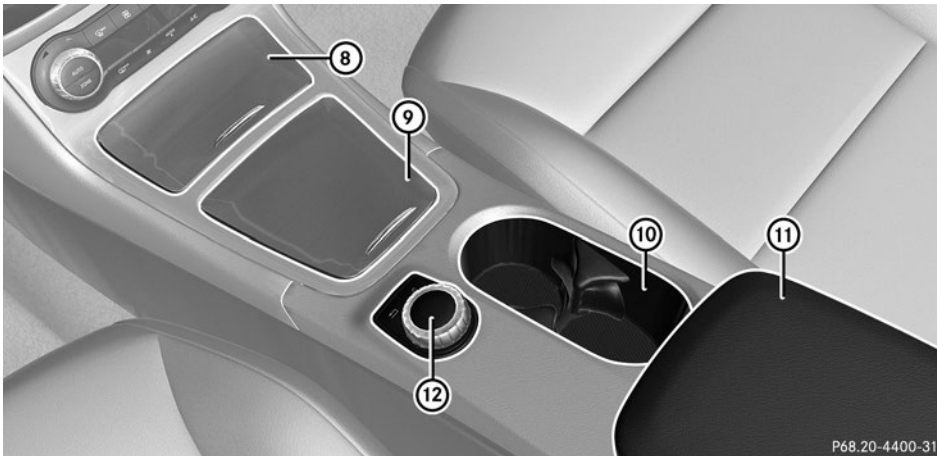







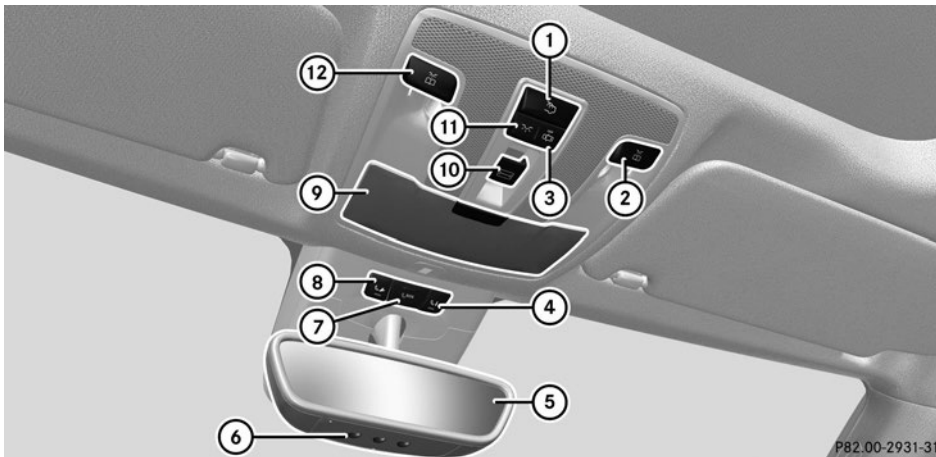

At a glance

	Function	Page		Function	Page
⑧	Ashtray	263	⑩	Cup holder	261
	Cigarette lighter	264		⑪	Stowage compartment
	Socket	264	⑫		Audio/COMAND controller; see the separate operating instructions
	Stowage compartment	251			
⑨	Stowage compartment	251			

Overhead control panel









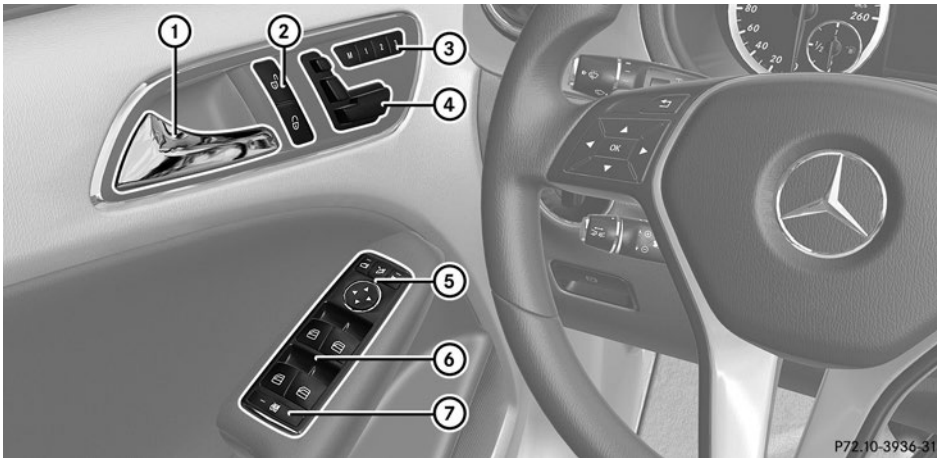



	Function	Page
①	 Switches the rear compartment interior lighting on/off	110
②	 Switches the right-hand reading lamp on/off	109
③	 Switches the front interior lighting/automatic interior lighting control off	110
④	 MB Info call button (mbrace system)	268
⑤	Rear-view mirror	99
⑥	Buttons for the garage door opener	276
⑦	 SOS button (mbrace system)	266



	Function	Page
⑧	 Roadside Assistance call button (mbrace system)	267
⑨	Eyeglasses compartment	251
⑩	 Opens/closes the panorama roof with power tilt/sliding panel with roller sunblinds	87
⑪	 Switches the front interior lighting on	110
⑫	 Switches the left-hand reading lamp on/off	109

Door control panel



At a glance

	Function	Page
①	Opens the door	79
②	  Unlocks/locks the vehicle	80
③	    Saves the seat and exterior mirror settings	101
④	Adjusts the seats electrically	95
⑤	    Adjusts and folds the exterior mirrors in/out electrically	99

	Function	Page
⑥	 Opens/closes the side windows	83
⑦	 Activates/deactivates the override feature for the side windows in the rear compartment	62

Useful information 40
Panic alarm 40
Occupant safety 40
Children in the vehicle 56
Driving safety systems 63
Theft deterrent locking system 70



Useful information

- i** This Operator's Manual describes all models and all standard and optional equipment of your vehicle available at the time of publication of the Operator's Manual. Country-specific differences are possible. Please note that your vehicle may not be equipped with all features described. This also applies to safety-related systems and functions.
- i** Read the information on qualified specialist workshops: (▷ page 25).

Panic alarm



- ▶ **To activate:** press **PANIC** button ① for at least one second.
An alarm sounds and the exterior lighting flashes.
 - ▶ **To deactivate:** press **PANIC** button ① again.
- or
- ▶ Insert the SmartKey into the ignition lock.

Occupant safety

Important safety notes

WARNING

Modifications to the restraint systems could result in them not functioning properly any more. The restraint systems could then no

longer protect vehicle occupants as they are designed to do and could fail in the event of an accident or activate unexpectedly, for example. There is an increased risk of injury. Never modify parts of the restraint systems. Do not attempt to modify the wiring as well as electronic components or their software.

If it is necessary to modify an air bag system to accommodate a person with disabilities, contact an authorized Mercedes-Benz center. USA only: for further information contact our Customer Assistance Center at 1-800-FOR-MERCEdes (1800-367-6372).

In this section, you will learn the most important facts about the restraint system components of the vehicle.

The restraint system consists of:

- Seat belts
- Child restraint systems
- LATCH-type (ISOFIX) child seat securing system

Additional protection is provided by:

- SRS (Supplemental Restraint System)
- Air bag system components with:
 - PASSENGER AIR BAG OFF indicator lamp
 - Front-passenger seat with Occupant Classification System (OCS)

Although the systems are independent, their protective functions work in conjunction with each other. Not all air bags are always deployed in an accident.

- i** For information on infants and children traveling with you in the vehicle restraint systems for infants and children, see "Children in the vehicle" (▷ page 56).

SRS (Supplemental Restraint System)

Introduction

Supplemental Restraint System (SRS) with:

- The  SRS warning lamp
- Air bags

- Air bag control unit (with crash sensors)
- Emergency Tensioning Device for the front seat belts and the outer seat belts in the rear
- Seat belt force limiter for the front seat belts and the outer seat belts in the rear

SRS reduces the risk of vehicle occupants coming into contact with parts of the vehicle's interior in the event of an accident. It can also reduce the forces to which vehicle occupants are subjected during an accident.

SRS warning lamp

WARNING

If SRS is malfunctioning, child restraint system components may be triggered unintentionally or might not be triggered at all in the event of an accident with a high rate of vehicle deceleration. There is an increased risk of injury, possibly even fatal.



Have SRS checked and repaired immediately at a qualified specialist workshop.

SRS functions are checked regularly when you switch on the ignition and when the engine is running. Therefore, malfunctions can be detected in good time.

The  SRS warning lamp in the instrument cluster lights up when the ignition is switched on. It goes out no later than a few seconds after the engine is started.

The SRS components are in operational readiness when the  SRS indicator lamp goes out while the engine is running.

There is a malfunction if:

- the  SRS warning lamp does not light up when the ignition is switched on
- the engine is running and the  SRS warning lamp does not go out after a few seconds
- the engine is running and the  SRS warning lamp lights up again

Triggering of Emergency Tensioning Devices and air bags

During the first stage of a collision, the air bag control unit evaluates important physical data relating to vehicle deceleration or acceleration, such as:

- duration
- direction
- magnitude

Based on the evaluation of this data, the air bag control unit pre-emptively triggers the Emergency Tensioning Device in the first stage.

If there is an even higher rate of vehicle deceleration or acceleration in a longitudinal direction, the front air bags are also deployed.

Your vehicle has adaptive, two-stage front air bags. The air bag control unit evaluates vehicle deceleration or acceleration in the event of a collision. In the first deployment stage, the front air bag is filled with enough propellant gas to reduce the risk of injuries. The front air bag is fully deployed if a second deployment threshold is reached within a few milliseconds.

The Emergency Tensioning Device and air bag triggering thresholds are variable and are adapted to the detected rate of deceleration or acceleration of the vehicle. This process is pre-emptive in nature. The triggering process must take place in good time at the start of the collision.

The rate of vehicle deceleration or acceleration and the direction of the force are essentially determined by:

- the distribution of forces during the collision
- the collision angle
- the deformation characteristics of the vehicle
- the characteristics of the object with which the vehicle has collided

Factors that can only be seen and measured after a collision has occurred do not play a

decisive role in the deployment of an air bag, nor do they provide an indication of air bag deployment.

The vehicle may be deformed significantly, e.g. the hood or the fender, without an air bag being deployed. This is the case if only parts which are relatively easily deformed are affected and the rate of deceleration is not high. Conversely, air bags may be deployed even though the vehicle suffers only minor deformation. This is the case if, for example, very rigid vehicle parts such as longitudinal body members are hit, and sufficient deceleration occurs as a result.

i The front Emergency Tensioning Devices can only be triggered if the seat belt tongues on the front seats are correctly engaged in the seat belt buckles.

i Not all air bags are deployed in an accident. The different air bag systems work independently of each other.

How the air bag system works is determined by predicting the severity of the accident, especially vehicle deceleration or acceleration, and the type of accident:

- head-on collision
- side impact
- rollover

Safety guidelines for seat belts, Emergency Tensioning Devices (ETDs) and air bags

WARNING

- Damaged seat belts or seat belts that have been subjected to stress in an accident must be replaced. Their anchoring points must also be checked. Only use seat belts installed or supplied by an authorized Mercedes-Benz Center.
- Air bags and pyrotechnic Emergency Tensioning Devices (ETDs) contain perchlorate material, which may require special handling and regard for the

environment. Check your national disposal guidelines. In California, see www.dtsc.ca.gov/HazardousWaste/Perchlorate/index.cfm.

- Air bags and ETDs are designed to function on a one-time-only basis. An air bag or ETD that has deployed must be replaced.
- Do not pass seat belts over sharp edges. They could tear.
- Do not make any modification that could change the effectiveness of the seat belts.
- Do not bleach or dye seat belts, as this may severely weaken them. In a crash, they may not be able to provide adequate protection.
- Do not make any modifications to the SRS wiring or components.
- Do not modify or remove any components or parts of the SRS.
- Do not install additional trim material, seat covers, badges, etc. to the:
 - padded steering wheel boss
 - knee bag covers
 - front-passenger air bag cover
 - outer side of front seat bolsters
 - outer seat bolsters of the rear bench seat backrest
 - roof frame trim
- Do not install additional electrical/ electronic equipment on or near SRS components and wiring.
- Keep the area between the air bags and occupants free of objects (e.g. packages, handbags, umbrellas etc.).
- Do not hang any objects such as coat hangers on the coat hooks or the grab handle above the door. These items may be thrown around in the vehicle and cause head and other injuries when the window curtain air bag is deployed.
- Air bag system components will be hot after an air bag has inflated. Do not touch them.
- Never rest your feet on the dashboard or the seat. Always keep both feet on the floor in front of the seat.

- Improper repair work on the SRS creates a risk of rendering the SRS inoperative or causing unintended air bag deployment. Work on the SRS must therefore only be performed by qualified technicians. Consult an authorized Mercedes-Benz Center.
- For your protection and the protection of others, when scrapping the air bag unit or ETD, our safety instructions must be followed. These are available from any authorized Mercedes-Benz Center.
- Given the considerable deployment speed, required inflation volume, and the material of the air bags, there is the possibility of abrasions or other, potentially more serious injuries resulting from air bag deployment.

If you sell your vehicle, Mercedes-Benz strongly recommends that you inform the subsequent owner that the vehicle is equipped with SRS. Also, refer them to the applicable section in the Operator's Manual.

Air bags

Important safety notes

NEVER use a rearward facing child restraint system on a seat protected by an ACTIVE AIR BAG in front of it, DEATH or SERIOUS INJURY to the CHILD can occur.

WARNING

Using unsuitable seat covers could restrict or even prevent deployment of the air bags integrated into the seats. Consequently, the air bags cannot protect vehicle occupants as they are designed to do. In addition, the function of the air bag deactivation system could be restricted. This poses an increased risk of injury or even fatal injury.

You should only use seat covers that have been approved for the respective seat by Mercedes-Benz.

WARNING

The air bag parts are hot after the airbag has been deployed. There is a risk of injury. Do not touch the air bag parts. Have the deployed air bags replaced at a qualified specialist workshop as soon as possible.

WARNING

Air bags are designed to reduce the incidence of injuries and fatalities in certain situations:

- frontal impacts (driver's and front-passenger front air bags and driver's knee bag)
- side impacts (side impact air bags and window curtain air bags)
- rollover (window curtain air bags)

However, no system available today can completely eliminate injuries and fatalities.

When the air bags are deployed, a small amount of powder is released. The powder generally does not constitute a health hazard and does not indicate that there is a fire in the vehicle. In order to prevent potential breathing difficulties, you should leave the vehicle as soon as it is safe to do so. If you have any breathing difficulty but cannot get out of the vehicle after the air bag inflates, then get fresh air by opening a window or door.

WARNING

In order to reduce the potential danger of injuries caused during the deployment of the front air bags, the driver and front passenger must always be correctly seated and wear their seat belts.

For maximum protection in the event of a collision, you must always be in the normal seat position with your back against the backrest. Fasten your seat belt and make sure that it is correctly positioned on your body.

As the air bag inflates with considerable speed and force, a proper seating position and correct positioning of the hands on the steering wheel will help to keep you at a safe distance from the air bag. Occupants who are not wearing their seat belt, are not seated properly or are too close to the air bag can be seriously injured or killed by an air bag, as it inflates with great force instantaneously:

- sit with the seat belt fastened correctly and in a position that is as upright as possible with your back against the backrest.
- move the driver's seat as far back as possible, still permitting proper operation of vehicle controls. The distance from the center of the driver's chest to the center of the air bag cover on the steering wheel must be at least 10 inches (25 cm). You should be able to accomplish this by adjusting the seat and steering wheel. If you have any difficulties, please contact an authorized Mercedes-Benz Center.
- do not lean your head or chest close to the steering wheel or dashboard.
- only hold the steering wheel on the outside. Placing hands and arms inside the rim can increase the risk and potential severity of hand/arm injury if the driver front air bag inflates.
- adjust the front-passenger seat as far back as possible from the dashboard when the seat is occupied.
- occupants, especially children, should never place their bodies or lean their heads in the area of the door where the side impact air bag inflates. This could result in serious or fatal injuries should the side impact air bag be deployed. Always sit as upright as possible, wear the seat belt properly and use an appropriately sized infant restraint, toddler restraint or booster seat recommended for the size and weight of the child.

Failure to follow these instructions can result in severe injuries to you or other occupants.

If you sell your vehicle, it is important that you make the buyer aware of this safety information. Be sure to give the buyer this Operator's Manual.

If the air bags are deployed, you will hear a bang, and a small amount of powder may also be released. Only in rare cases will the bang affect your hearing. The powder that is released generally does not constitute a health hazard and does not indicate that there is a fire in the vehicle. The dust might cause some temporary breathing difficulty for people with asthma or other breathing trouble. To avoid this, you may wish to get out of the vehicle as soon as it is safe to do so. You can also open the window to allow fresh air to enter the vehicle interior. The  SRS warning lamp lights up.

The air bag installation locations are identified by the AIR BAG symbol.

The air bags are deployed if the air bag control unit detects the need for deployment. Only in the event of such a situation will the air bags provide their supplemental protection.

If the driver and front passenger do not wear their seat belts, it is not possible for the air bags to provide their supplemental protection.

In the event of other types of impacts and impacts below air bag deployment thresholds, the air bags will not deploy. The driver and passenger will then be protected to the extent possible by a properly fastened seat belt. A properly fastened seat belt is also needed to provide the best possible protection in a rollover.

Air bags provide additional protection; they are not, however, a substitute for seat belts. All vehicle occupants must fasten their seat belts regardless of whether your vehicle is equipped with air bags or not.

It is important for your safety and that of your passenger to have deployed air bags replaced and to have any malfunctioning air bags repaired. This will help to make sure the air bags continue to perform their protective

function for the vehicle occupants in the event of a crash.

- i** After an air bag has been deployed, have the vehicle towed to the nearest qualified specialist workshop, even if your vehicle is ready to drive.

Front air bags

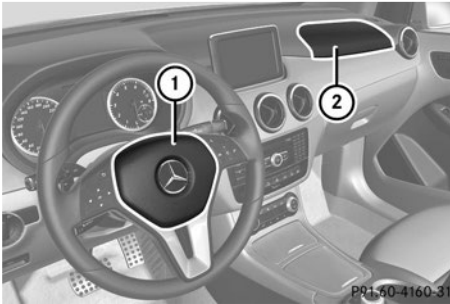

Driver's air bag ① deploys in front of the steering wheel; front-passenger front air bag ② deploys in front of and above the glove box.

The front air bags increase protection for the driver's and front passenger's head and chest.

They are deployed:

- at the start of an accident with a high rate of vehicle acceleration or deceleration in a longitudinal direction
- if the system determines that air bag deployment can offer additional protection to that provided by the seat belt
- independently of other air bags in the vehicle

The release time of the front air bags is dependent upon the use of the seat belt.

If the vehicle rolls over, the front air bags are generally not deployed.

Your vehicle has adaptive, two-stage front air bags. The air bag control unit evaluates vehicle deceleration or acceleration in the event of a collision. In the first deployment stage, the front air bag is filled with part of the total available propellant gas, thereby

reducing the risk of injury. If the air bag control unit recognizes within a few milliseconds that the vehicle is being braked or accelerated faster than originally predicted, the front air bag is filled with the maximum amount of propellant gas available.

The deployment of the front-passenger front air bag is also influenced by the weight category of the front passenger, which is determined by the Occupant Classification System (OCS) (▷ page 47).

The lighter the passenger-side occupant, the higher the vehicle deceleration rate required (predicted at the start of the impact) for second stage inflation of the front-passenger front air bag. In the second stage, the front air bags are inflated with the maximum amount of propellant gas available.

The front air bags are not deployed in situations where a low impact severity is predicted. You will then be protected by the fastened seat belt.

The front-passenger front air bag will only deploy if:

- the system, based on the OCS weight sensor readings, detects that the front-passenger seat is occupied
- the PASSENGER air bag OFF indicator lamp on the center console is not lit (▷ page 47)
- the air bag control unit predicts a high impact severity

Driver's knee bag

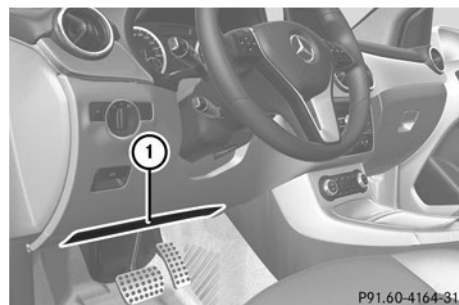

Driver's knee bag ① deploys under the steering column. The driver's knee bag is always deployed along with the driver's front air bag. The driver's knee bag is designed to operate together with the front air bags in frontal impacts if certain thresholds are exceeded. The driver's knee bag operates best in conjunction with correctly positioned and fastened seat belts.

Driver's knee bag ① increases the driver's protection against:

- knee injuries
- thigh injuries
- lower leg injuries

Side impact air bags

WARNING

Using unsuitable seat covers could restrict or even prevent deployment of the air bags integrated into the seats. Consequently, the air bags cannot protect vehicle occupants as they are designed to do. In addition, the function of the air bag deactivation system could be restricted. This poses an increased risk of injury or even fatal injury.

You should only use seat covers that have been approved for the respective seat by Mercedes-Benz.

WARNING

Sensors to control the air bags are located in the doors. Modifications or work not performed correctly to the doors or door paneling, as well as damaged doors, can lead to the function of the sensors being impaired. The air bags might therefore not function properly any more. Consequently, the air bags cannot protect vehicle occupants as they are designed to do. There is an increased risk of injury.

Never modify the doors or parts of the doors. Always have work on the doors or door paneling carried out at a qualified specialist workshop.

You should only use seat covers that have been approved for your vehicle by Mercedes-Benz. The seat covers must have a special tear seam for side impact air bags. Otherwise, the side impact air bags cannot deploy correctly and therefore cannot provide the intended protection in the event of an accident.

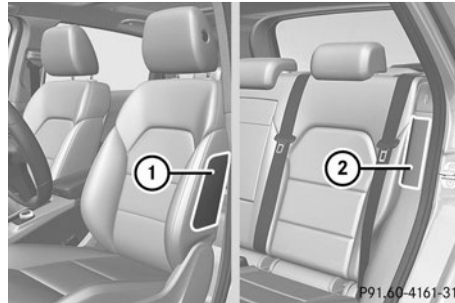

Front side impact air bags ① and rear side impact air bags ② deploy next to the outer seat cushions.

When deployed, the side impact air bags offer additional protection of the thorax for occupants on the front seats as well as also of the pelvis for the vehicle occupants on the side of the vehicle on which the impact occurs. However, they do not protect the:

- head
- neck
- arms

The side impact air bags are deployed:

- on the side on which an impact occurs
- at the start of an accident with a high rate of lateral vehicle deceleration or acceleration, e.g. in a side impact
- independently of the use of the seat belt
- independently of the front air bags
- independently of the ETDs

If the vehicle rolls over, the side impact air bags are generally not deployed. Side impact air bags are deployed if the system detects high vehicle deceleration or acceleration in a lateral direction and determines that side impact air bag deployment can offer

additional protection to that provided by the seat belt.

Side impact air bags will not deploy in side impacts which do not exceed the system's preset deployment thresholds for lateral acceleration/deceleration. You will then be protected by the fastened seat belt.

The side impact air bag on the front-passenger side is not deployed in the following situations:

- OCS has detected that the front-passenger seat is unoccupied.
- the front-passenger seat belt is not fastened.

The side impact air bag on the front-passenger side will deploy if the front-passenger seat belt is fastened, regardless of whether the front-passenger seat is occupied or not.

Window curtain air bags

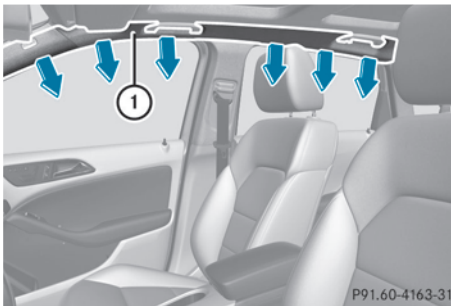

Window curtain air bags (1) enhance the level of protection for the head, but not chest or arms, of the vehicle occupants on the side of the vehicle on which the impact occurs.

Window curtain air bags (1) are integrated into the side of the roof frame and deployed in the area from the A-pillar to the C-pillar.

Window curtain air bags are deployed:

- at the start of an accident with a high rate of lateral vehicle deceleration or acceleration, e.g. in a side impact
- on the side on which an impact occurs



- on the driver's side and passenger side, in the event of a vehicle rollover and if the system determines that air bag deployment can offer the vehicle occupants additional protection to that provided by the seat belt
- independently of the use of the seat belt
- regardless of whether the front-passenger seat is occupied
- independently of the front air bags

Window curtain air bags (1) will not deploy in the event of impacts which do not exceed the system's preset deployment thresholds for vehicle acceleration/deceleration. You will then be protected by the fastened seat belt.

Occupant Classification System (OCS)

Method of operation



WARNING

If the  indicator lamp illuminates when an adult or someone larger than a small individual is in the front-passenger seat, have the front passenger reposition himself or herself in the seat until the  indicator lamp goes out.



In the event of a collision, the air bag control unit will not allow front-passenger front air bag deployment when the OCS has classified the front-passenger seat occupant as weighing as much as or less than a typical 12-month-old child in a standard child restraint or if the front-passenger seat is classified as being empty.





When the OCS senses that the front-passenger seat occupant is classified as being up to or less than the weight of a typical 12-month-old child in a standard child restraint, the  indicator lamp will illuminate when the engine is started and remain illuminated, indicating that the front-passenger front air bag is deactivated.



When the OCS senses that the front-passenger seat is classified as being empty,



the   indicator lamp will illuminate when the engine is started and remain illuminated, indicating that the front-passenger front air bag is deactivated.



When the OCS senses that the front-passenger seat occupant is classified as being heavier than the weight of a typical 12-month-old child seated in a standard child restraint or as being a small individual (such as a young teenager or a small adult), the

  indicator lamp will illuminate for approximately 6 seconds when the engine is started and then, depending on occupant weight sensor readings from the front-passenger seat, remain illuminated or go out.

With the   indicator lamp illuminated, the front-passenger front air bag is deactivated. With the   indicator lamp out, the front-passenger front air bag is activated.

When the OCS senses that the front-passenger seat occupant is classified as an adult or someone larger than a small individual, the   indicator lamp will illuminate for approximately 6 seconds when the engine is started and then go out, indicating that the front-passenger front air bag is activated.

If the   indicator lamp is illuminated, the front-passenger front air bag is deactivated and will not be deployed.

If the   indicator lamp is not illuminated, the front-passenger front air bag is activated and will be deployed:

- in the event of certain frontal impacts
- if impact exceeds a preset deployment threshold
- independently of the side impact air bags

If the front-passenger front air bag is deployed, the rate of inflation will be influenced by:

- the rate of relevant vehicle deceleration as assessed by the air bag control unit
- the front passenger's weight category as identified by OCS

WARNING

According to accident statistics, children are safer when properly restrained on the rear seats than on the front-passenger seat. Thus, we strongly recommend that children be placed in the rear seats whenever possible. Regardless of seating position, children 12 years old and under must be seated and properly secured in an appropriate infant restraint, toddler restraint, or booster seat recommended for the size and weight of the child.





The infant or child restraint must be properly secured with the vehicle's seat belt, the seat belt and Top Tether strap, or lower anchors and Top Tether strap, fully in accordance with the child seat manufacturer's instructions.

Occupants, especially children, should always sit as upright as possible, wear the seat belt properly and use an appropriately sized infant restraint, toddler restraint, or booster seat recommended for the size and weight of the child.

Children can be killed or seriously injured by an inflating air bag. Note the following important information when circumstances require you to place a child in the front-passenger seat:

- Your vehicle is equipped with air bag technology designed to deactivate the front-passenger front air bag in your vehicle when the system senses the weight of a typical 12-month-old child or less along with the weight of a standard appropriate child restraint on the front-passenger seat.
- A child in a rear-facing child restraint on the front-passenger seat will be seriously injured or even killed if the front-passenger front air bag inflates in a collision which could occur under some circumstances, even with the air bag technology installed in your vehicle. The only means to eliminate this risk completely is never to place a child in a rear-facing child restraint in the front-passenger seat. We therefore strongly recommend that you always place a child



in a rear-facing child restraint on the rear seat.

- If you install a rear-facing child restraint on the front-passenger seat, make sure the  indicator lamp is illuminated, indicating that the front-passenger front air bag is deactivated. Should the  indicator lamp not illuminate or go out while the restraint is installed, please check installation. Periodically check the  indicator lamp while driving to make sure that the  indicator lamp is illuminated. If the  indicator lamp goes out or remains out, do not transport a child on the front-passenger seat until the system has been repaired.

A child in a rear-facing child restraint on the front-passenger seat will be seriously injured or even killed if the front-passenger front air bag inflates.

- If you place a child in a forward-facing child restraint on the front-passenger seat:
 - move the seat as far back as possible
 - use the proper child restraint recommended for the age, size and weight of the child
 - secure child restraint with the vehicle's seat belt according to the child seat manufacturer's instructions
- For children larger than the typical 12-month-old child, the front-passenger front air bag may or may not be activated.

WARNING

If the red  SRS warning lamp in the instrument cluster and the  indicator lamp light up simultaneously, the OCS is malfunctioning. The front passenger front air bag will be deactivated in this case. Have the system checked by qualified technicians as soon as possible. Contact an authorized Mercedes-Benz Center.

Only have the seat repaired or replaced at an authorized Mercedes-Benz Center.

In order to ensure proper operation of the air bag system and OCS:

- Sit with the seat belt properly fastened in a position that is as upright as possible with your back against the seat backrest.
- When seated, a passenger should not position him/herself in such a way as to cause the passenger's weight to be lifted from the seat cushion as this may result in the OCS being unable to correctly approximate the passenger's weight category.
- Read and observe all warnings in this chapter.



If the SmartKey is removed from the ignition lock or is in position **0**, PASSENGER AIR BAG OFF indicator lamp **1** does not light up.

The Occupant Classification System (OCS) categorizes the occupant on the front-passenger seat using a weight sensor.

The front-passenger front air bag is deactivated automatically for certain weight categories.

The PASSENGER AIR BAG OFF indicator lamp shows you the current status.

The system does not deactivate:

- the side impact air bag
- the window curtain air bag
- the Emergency Tensioning Devices

To be classified correctly, the front passenger must sit:

- with the seat belt fastened correctly
- in a position that is as upright as possible with their back against the seat backrest
- with their feet on the floor

The OCS weight sensor reading is affected if the occupant's weight is transferred, e.g. by leaning on the armrest.

If the front-passenger seat, the seat cover or the seat cushion are damaged, have the necessary repair work carried out at a qualified specialist workshop.

For safety reasons, Mercedes-Benz recommends that you only use seat accessories that have been approved by Mercedes-Benz.

Both the driver and the front passenger should always observe the PASSENGER AIR BAG OFF indicator lamp as an indication of whether or not the front passenger is positioned correctly. Observe also the air bag display messages that can be displayed in the instrument cluster (▷ page 219).

If the driver's air bag deploys, this does not mean that the front-passenger front air bag will also deploy.

The OCS may have detected that the seat:



- is empty or occupied by the weight of a typical child up to twelve months old, seated in a child restraint system.
- is occupied by a small individual, such as a young teenager or a small adult.
- is occupied by a child in a child restraint system whose weight is greater than that of a typical twelve month old child.

These are examples of when the OCS deactivates the front-passenger front air bag. Deactivation takes place although the collision fulfills the criteria for deploying the driver's air bag.

For further information, see "Air bag display messages" (▷ page 219).

System self-test

WARNING

If the   indicator lamp does not illuminate, the system is not functioning. You must contact an authorized Mercedes-Benz Center before seating any child on the front passenger seat.

WARNING

Never place anything between seat cushion and child seat (e.g. a pillow), since it reduces the effectiveness of the OCS. The underside and rear side child restraint system must be placed entirely on the seat cushion and the backrest of the front-passenger seat backrest.

If necessary, adjust the tilt of the passenger seat backrest.

An incorrectly mounted child seat could cause injuries to the child in case of an accident, instead of increasing protection for the child.

Follow the manufacturer's instructions for installation of child restraint systems.

The PASSENGER AIR BAG OFF indicator lamp lights up:

- if you turn the SmartKey in the ignition lock to position **1** or **2**
- if an adult is seated properly on the front-passenger seat and the OCS classifies the occupant as an adult

The PASSENGER AIR BAG OFF indicator lamp goes out again after approximately six seconds.

If the seat is not occupied and the OCS detects that the front-passenger seat is empty, the PASSENGER AIR BAG OFF indicator lamp will continue to light up. The PASSENGER AIR BAG OFF indicator lamp will not go out.

For further information, see "Problems with the Occupant Classification System" (▷ page 51).

Problems with the Occupant Classification System

Problem	Possible causes/consequences and ► Solutions
<p>The PASSENGER AIR BAG OFF indicator lights up and remains on.</p> <p>The person on the front-passenger seat:</p> <ul style="list-style-type: none"> • has the weight of a typical adult • has been determined by the system not to be a child 	<p>The OCS is malfunctioning.</p> <ul style="list-style-type: none"> ► Make sure that the front passenger is sitting in a correct, upright position. ► Have the OCS checked as soon as possible at a qualified specialist workshop. ► Observe the additional display messages in the multifunction display (▷ page 219).

WARNING

If the  indicator lamp illuminates and remains illuminated when the weight of a typical adult or someone larger than a small individual has been detected on the passenger seat, do not allow any occupant to use the passenger seat until the system has been repaired.

Problem	Possible causes/consequences and ► Solutions
<p>The PASSENGER AIR BAG OFF indicator lamp does not light up and/or stays on.</p> <p>The front-passenger seat is:</p> <ul style="list-style-type: none"> • unoccupied • occupied with the weight of a child up to twelve months old in a child restraint system 	<p>The OCS is malfunctioning.</p> <ul style="list-style-type: none"> ► Make sure there is nothing between the seat cushion and the child seat. ► Make sure that the backrest and base of the child restraint system are resting securely on the front-passenger seat. If necessary, adjust the position of the front-passenger seat. ► When installing the child restraint system, make sure that the seat belt is tight. Do not pull the seat belt tight with the front-passenger seat adjustment. This could result in the seat belt being pulled too tightly. ► Check the installation of the child restraint system. ► Make sure that no objects are applying additional weight onto the seat. ► If the PASSENGER AIR BAG OFF indicator lamp remains off, have the OCS checked immediately at a qualified specialist workshop. Do not transport a child on the front-passenger seat until the OCS has been repaired. ► Observe the additional display messages in the multifunction display (▷ page 219).

⚠ WARNING

If the  indicator lamp does not illuminate or remains out with the weight of a typical 12-month-old child in a standard child restraint or less, or is unoccupied, on the front-passenger seat, do not transport a child on the front-passenger seat until the system has been repaired.

Seat belts**Important safety notes****⚠ WARNING**

The seat belt does not offer the intended level of protection if the backrest is not in the upright position. When braking or in the event of an accident, you could slide underneath the seat belt and sustain abdomen or neck injuries, for example. This poses an increased risk of injury or even fatal injury.

Adjust the seat properly before beginning your journey. Always make sure that the seat is in the upright position.

⚠ WARNING

Seat belts cannot protect as intended, if:

- they are damaged, extremely dirty, bleached or dyed
- the seat belt buckle is damaged or extremely dirty
- the Emergency Tensioning Devices or the belt anchorage has been modified.

Damage caused to seat belts in an accident may not be visible, e.g. by splinters of glass. Modified or damaged seat belts can tear or fail, for example in the event of an accident. Modified Emergency Tensioning Devices may be deployed unintentionally or fail to be deployed when required. There is an increased risk of injury, possibly even fatal.

Never modify seat belts, Emergency Tensioning Devices, seat belt anchorages and inertia reels. Ensure that seat belts are not damaged or worn and are clean.

Only use seat belts that have been approved for your vehicle by Mercedes-Benz.

The use of seat belts and infant and child restraint systems is required by law in:

- all 50 states
- the U.S. territories
- the District of Columbia
- all Canadian provinces

Even where this is not required by law, all vehicle occupants should correctly fasten their seat belts before starting the journey.

- **i** See "Children in the vehicle" (▷ page 56) for further information on infants and children traveling in the vehicle as well as on child restraint systems.

Proper use of the seat belts**⚠ WARNING****USE SEAT BELTS PROPERLY**

- Seat belts can only work when used properly. Never wear seat belts in any other way than as described in this section, as that could result in serious injuries in the event of an accident.
- Each occupant should wear their seat belt at all times, because seat belts help reduce the likelihood of and potential severity of injuries in accidents, including rollovers. The integrated restraint system includes SRS (driver front air bag, driver's side knee bag, front-passenger front air bag, side impact air bags, window curtain air bags for the side windows), Emergency Tensioning Devices, seat belt force limiters, and front seat knee bolsters.

The system is designed to enhance the protection offered to properly belted occupants in certain frontal (front air bags, driver's side knee bag and ETDs) and side (side impact air bags, window curtain air

bags, and ETDs) impacts which exceed preset deployment thresholds and in certain rollovers (window curtain air bags and ETDs).

- Never wear the shoulder belt under your arm, across your neck or off your shoulder. In a frontal crash, your body would move too far forward. That would increase the chance of head and neck injuries. The seat belt would also apply too much force to the ribs or abdomen, which could severely injure internal organs such as your liver or spleen.

Adjust the seat belt so that the shoulder section is located as close as possible to the middle of the shoulder. It should not touch the neck. Never pass the shoulder portion of the seat belt under your arm. For this purpose, you can adjust the height of the seat belt outlet.

- Position the lap belt as low as possible on your hips and not across the abdomen. If the lap belt is positioned across your abdomen, it could cause serious injuries in a crash.
- Never wear seat belts over rigid or breakable objects in or on your clothing, such as eyeglasses, pens, keys etc., as these might cause injuries.
- Make sure the seat belt is always fitted snugly. Take special care of this when wearing loose clothing.
- Never use a seat belt for more than one person at a time. Do not fasten a seat belt around a person and another person or other objects at the same time.
- Seat belts should not be worn twisted. In a crash, you would not have the full width of the seat belt to distribute impact forces. The twisted seat belt against your body could cause injuries.
- Pregnant women should also always use a lap-shoulder belt. The lap belt portion should be positioned as low as possible on the hips to avoid any possible pressure on the abdomen.

- Place the seat backrest in a position that is as upright as possible.
- Check your seat belt during travel to make sure it is properly positioned.
- Never place your feet on the instrument panel, dashboard, or on the seat. Always keep both feet on the floor in front of the seat.
- When using a seat belt to secure infant restraints, toddler restraints, or children in booster seats, always follow the child seat manufacturer's instructions.

WARNING

Do not pass seat belts over sharp edges. They could tear.

Do not allow the seat belt to get caught in the door or in the seat adjustment mechanism. This could damage the seat belt.

Never attempt to make modifications to seat belts. This could impair the effectiveness of the seat belts.

Fastening seat belts

WARNING

According to accident statistics, children are safer when properly restrained on the rear seats than on the front-passenger seat. Thus, we strongly recommend that children be placed in the rear seat whenever possible. Regardless of seating position, children 12 years old and under must be seated and properly secured in an appropriately sized child restraint system or booster seat recommended for the size and weight of the child. For additional information, see the "Children in the vehicle" section.

A child's risk of serious or fatal injuries is significantly increased if the child restraints are not properly secured in the vehicle and/or the child is not properly secured in the child restraint.

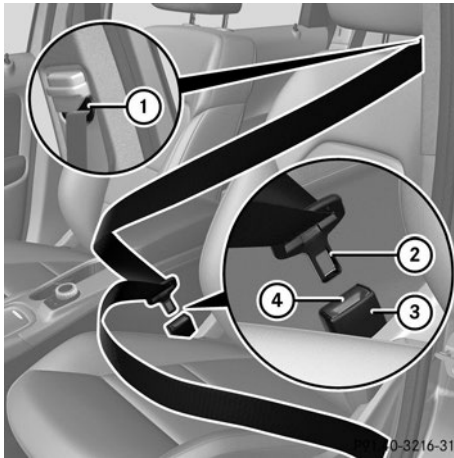

- ▶ Adjust the seat and move the backrest to an almost vertical position (▷ page 92).
- ▶ Pull the seat belt smoothly through belt sash guide ①.
- ▶ Without twisting it, guide the shoulder section of the seat belt across the middle of your shoulder and the lap section across your pelvis.
- ▶ Engage belt tongue ② in buckle ③.
- ▶ If necessary, adjust the seat belt to the appropriate height (▷ page 54).
- ▶ If necessary, pull upwards on the shoulder section of the seat belt to tighten the belt across your body.

Information on releasing the seat belt with release button ④ (▷ page 54).

Belt height adjustment



You can adjust the seat belt height on the front seats. Adjust the belt to a height that allows the upper part of the seat belt to be routed across the center of your shoulder.

- ▶ **To raise:** slide the belt sash guide upwards. The belt sash guide engages in various positions.
- ▶ **To lower:** press and hold belt sash guide release ①.
- ▶ Slide the belt sash guide downwards.
- ▶ Release belt sash guide release ① and make sure that the belt sash guide has engaged.

Using the seat belt for the center rear-compartment seat

If the left-hand rear seat backrest is folded down and back up again, the rear center seat belt may lock. The seat belt can then not be pulled out.

- ▶ **To release the rear center seat belt:** pull the seat belt out approximately 1 in (25 mm) at the belt outlet on the backrest and then release it again. The seat belt is retracted and released.

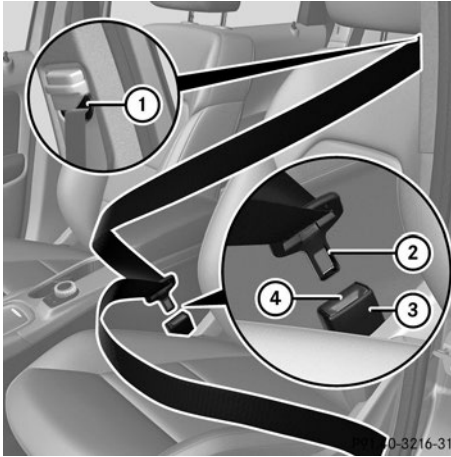

Releasing seat belts

- ❗ Make sure that the seat belt is fully rolled up. Otherwise, the seat belt or belt tongue will be trapped in the door or in the seat mechanism. This could damage the door, the door trim panel and the seat belt. Damaged seat belts can no longer fulfill their protective function and must be replaced. Visit a qualified specialist workshop.





- ▶ Press release button ④ on belt buckle ③.
- ▶ Guide belt tongue ② back to belt sash guide ①.

Belt warning for the driver and front passenger

Every time the engine is started, the  seat belt warning lamp lights up for six seconds. It lights up regardless of whether the driver's and front-passenger seat belts have already been fastened. If the driver's and front-passenger seat belts have already been fastened, the  seat belt warning lamp then goes out.

If the driver's seat belt is not fastened when the engine is started, an additional warning tone will sound. This warning tone stops after a maximum of six seconds or once the driver's seat belt is fastened.

If after six seconds, the driver or front passenger have not fastened their seat belts and the doors are closed:

- the  seat belt warning lamp remains lit as long as the driver's or front-passenger's seat belt is not fastened and
- if a vehicle speed of 15 mph (25 km/h) is exceeded, the  seat belt warning lamp begins to flash. A warning tone also sounds

with increasing intensity for a maximum of 60 seconds or until the driver or front passenger have fastened their seat belts.

If the driver/front passenger unfasten their seat belt while the vehicle is in motion, the  seat belt warning lamp lights up and a warning tone sounds again.

The warning tone ceases even if the driver or front-passenger seat belt has still not been fastened after 60 seconds. The  seat belt warning lamp stops flashing but remains illuminated.

After the vehicle comes to a standstill, the warning tone is reactivated. The  seat belt warning lamp flashes again if the vehicle speed exceeds 15 mph (25 km/h).

The  seat belt warning lamp only goes out if:

- both the driver and the front passenger have fastened their seat belts.
- or
- the vehicle is stationary and a door is open.

i For more information on the  seat belt warning lamp, see "Warning and indicator lamps in the instrument cluster, seat belts" (▶ page 237).

Emergency Tensioning Devices, seat belt force limiters

WARNING

Pyrotechnic Emergency Tensioning Devices that have been deployed are no longer operational and are unable to perform their intended protective function. This poses an increased risk of injury or even fatal injury.

Therefore, have pyrotechnic Emergency Tensioning Devices which have been triggered immediately replaced at a qualified specialist workshop.

! If the front-passenger seat is not occupied, do not engage the seat belt tongue in the buckle on the front-passenger seat. Otherwise, the Emergency

Tensioning Device could be triggered in the event of an accident.

The front seat belts and the outer seat belts in the rear are equipped with Emergency Tensioning Devices and seat belt force limiters.

The ETDs tighten the seat belts in an accident, pulling them close against the body.

The ETDs do not correct incorrect seat positions or incorrectly fastened seat belts.

The ETDs do not pull vehicle occupants back towards the backrest.

The ETDs can only be activated when:

- the ignition is switched on.
- the restraint systems are operational; see " SRS warning lamp" (▷ page 41).
- the belt tongue is engaged in the buckle on each of the front seat belts.

The ETDs on the outside seats in the rear compartment are triggered independently of the lock status of the seat belts.

The ETDs are triggered depending on the type and severity of an accident:

- in the event of a head-on or rear-end collision if the vehicle decelerates or accelerates rapidly in a longitudinal direction during the initial stages of the impact.
- in the event of a side impact if the vehicle decelerates or accelerates rapidly in a lateral direction on the side opposite to the impact.
- in certain situations where the vehicle rolls over if the system determines that it can provide additional protection.

If the ETDs are deployed, you will hear a bang, and a small amount of powder may also be released. Only in rare cases will the bang affect your hearing. The powder that is released generally does not constitute a health hazard and does not indicate that there is a fire in the vehicle. The dust might cause some temporary breathing difficulty for people with asthma or other breathing trouble. To avoid this, you may wish to get out

of the vehicle as soon as it is safe to do so. You can also open the window to allow fresh air to enter the vehicle interior. The  SRS warning lamp lights up.

If the seat belt is also equipped with a seat belt force limiter and this is triggered, the force exerted by the seat belt on the vehicle occupant is reduced.

The seat belt force limiters for the front seats are synchronized with the front air bags, which take on a part of the deceleration force. This results in the force exerted on the occupant being distributed over a greater area.

Children in the vehicle

Child restraint systems

Important safety notes







WARNING

According to accident statistics, children are safer when properly restrained in the rear seating positions than in the front seating position. Thus, we strongly recommend that children be placed in the rear seats whenever possible. Regardless of seating position, children 12 years old and under must be seated and properly secured in an appropriate infant restraint, toddler restraint, or booster seat recommended for the size and weight of the child.

The infant or child restraint must be properly secured with the vehicle's seat belt, the seat belt and top tether strap, or lower anchors and top tether strap, fully in accordance with the child seat manufacturer's instructions.

Occupants, especially children, should always sit as upright as possible, wear the seat belt properly and use an appropriately sized infant restraint, toddler restraint, or booster seat recommended for the size and weight of the child.

Children can be killed or seriously injured by an inflating air bag. Note the following important information when circumstances require you to place a child in the front passenger seat:

- Your vehicle is equipped with air bag technology designed to deactivate the front passenger front air bag in your vehicle when the system senses the weight of a typical 12-month-old child or less along with the weight of a standard appropriate child restraint on the front passenger seat.
- For children larger than the typical 12-month-old child, the front passenger front air bag may or may not be activated. Always make sure the  **PASS AIR BAG OFF** indicator lamp is illuminated, indicating that the front passenger front air bag is deactivated.
- A child in a rear-facing child restraint on the front passenger seat will be seriously injured or even killed if the front passenger front air bag inflates in a collision which could occur under some circumstances, even with the air bag technology installed in your vehicle. The only means to completely eliminate this risk is to never place a child in a rear-facing child restraint in the front seat. We therefore strongly recommend that you always place a child in a rear-facing child restraint in a backseat.
- If you must install a rear-facing child restraint on the front passenger seat because circumstances require you to do so, make sure the  **PASS AIR BAG OFF** indicator lamp is illuminated, indicating that the front passenger front air bag is deactivated. Should the  **PASS AIR BAG OFF** indicator lamp not illuminate or go out while the restraint is installed, please check installation. Periodically check the  **PASS AIR BAG OFF** indicator lamp while driving to make sure the  **PASS AIR BAG OFF** indicator lamp is illuminated. If the  **PASS AIR BAG OFF** indicator lamp goes out or remains out, do not transport a child on the front passenger seat until the system has been repaired.

A child in a rear-facing child restraint on the front passenger seat will be seriously injured or even killed if the front passenger front air bag inflates.

- If you have to place a child in a forward-facing child restraint on the front passenger seat, move the seat as far back as possible, use the proper child restraint recommended for the age, size and weight of the child, and secure child restraint with the vehicle's seat belt according to the child seat manufacturer's instructions.

WARNING

If the child restraint system is installed incorrectly on a suitable seat, it cannot protect as intended. The child cannot then be restrained in the event of an accident, heavy braking or sudden changes of direction. There is an increased risk of injury, possibly even fatal.

Make sure that you observe the child restraint system manufacturer's installation instructions and the notes on use. Please ensure, that the base of the child restraint system is always resting completely on the seat cushion. Never place objects, e.g. cushions, under or behind the child restraint system. Only use child restraint systems with the original cover designed for them. Only replace damaged covers with genuine covers.

WARNING

If the child restraint system is installed incorrectly or is not secured, it can come loose in the event of an accident, heavy braking or a sudden change in direction. The child restraint system could be thrown about, striking vehicle occupants. There is an increased risk of injury, possibly even fatal. Always install child restraint systems properly, even if they are not being used. Make sure that you observe the child restraint system manufacturer's installation instructions.

 **WARNING**

Child restraint systems or their securing systems which have been damaged or subjected to a load in an accident can no longer protect as intended. The child cannot then be restrained in the event of an accident, heavy braking or sudden changes of direction. There is an increased risk of injury, possibly even fatal.

Replace child restraint systems which have been damaged or subjected to a load in an accident as soon as possible. Have the securing systems on the child restraint system checked at a qualified specialist workshop, before you install a child restraint system again.

 **WARNING**

Infants and small children should never share a seat belt with another occupant. In the event of an accident, they could be crushed between the occupant and seat belt.

A child's risk of serious or fatal injuries is significantly increased if the child restraints are not properly secured in the vehicle and/or the child is not properly secured in the child restraint.

Children that are too large for a child restraint must travel in seats using normal seat belts. Position the shoulder belt across the chest and shoulder, not the face or neck. A booster seat may be necessary to achieve proper seat belt positioning for children over 41 lbs (18 kg) until they reach a height where a lap/shoulder belt fits properly without a booster seat.

When the child restraint is not in use, remove it from the vehicle or secure it with the seat belt to prevent the child restraint from becoming a projectile in the event of an accident.

 **WARNING**

If children are left unsupervised in the vehicle, they could:

- open the doors, thus endangering other people or road users.
- get out and disrupt traffic.
- operate the vehicle's equipment.

Additionally, children could set the vehicle in motion if, for example, they:

- release the parking brake.
- shifting the automatic transmission out of park position **P**
- Start the engine.

There is a risk of an accident and injury.

When leaving the vehicle, always take the SmartKey with you and lock the vehicle. Never leave children or animals unattended in the vehicle. Always keep the SmartKey out of reach of children.

 **WARNING**

If persons, particularly children are subjected to prolonged exposure to extreme heat or cold, there is a risk of injury, possibly even fatal. Never leave children unattended in the vehicle.

 **WARNING**

If the child restraint system is subjected to direct sunlight, parts may get very hot. Children may burn themselves on these parts, particularly on the metal parts of the child restraint system. There is a risk of injury.

If you leave the vehicle, taking the child with you, always ensure that the child restraint system is not exposed to direct sunlight. Protect it with a blanket, for example. If the child restraint system has been exposed to direct sunlight, let it cool down before securing the child in it. Never leave children unattended in the vehicle.

If an infant or child is traveling in the vehicle:

- Secure the child with a child or infant seat restraint system appropriate to the age and weight of the child.
- Make sure that the infant or child is properly secured at all times while the vehicle is in motion.

Mercedes-Benz recommends that you always properly secure all infants and children with a child or infant seat restraint system for the trip.

The use of seat belts and infant and child restraint systems is required by law in:

- all 50 states
- the U.S. territories
- the District of Columbia
- all Canadian provinces

Infants and children must always be seated in an appropriate infant or child restraint system recommended for the size and weight of the child. The infant or child restraint system must be properly secured in accordance with the manufacturer's instructions.

All infant or child restraint systems must meet the following standards:

- U.S. Federal Motor Vehicle Safety Standards 213 and 225
- Canadian Motor Vehicle Safety Standards 213 and 210.2

Confirmation that the child restraint system corresponds to the standards can be found on an instruction label on the child restraint system. This confirmation can also be found in the installation instructions that are included with the child restraint system.

Always read and follow the manufacturer's instructions when using an infant or child restraint system or booster seat.

Observe the warning labels in the vehicle interior or on the infant or child restraint.

Child restraint system on the front-passenger seat

WARNING

If the front-passenger air bag is not disabled:

- a child secured in a child restraint system on the front-passenger seat could be seriously or even fatally injured by the front-passenger air bag deploying. This is especially a risk if the child is in the immediate vicinity of the front-passenger air bag when it deploys.
- never secure a child on the front-passenger seat in a rearward-facing child restraint system. Only secure a rearward-facing child restraint system on a suitable rear seat.
- always move the front-passenger seat to the rearmost position if you secure a child in a forward-facing child restraint system on the front-passenger seat.

The front-passenger air bag is not disabled:

- on vehicles without an air bag deactivation system on the front-passenger seat.
- on vehicles with an air bag deactivation system on the front-passenger seat, unless a child restraint system with transponders for an air bag deactivation system is installed on the front-passenger seat
- on vehicles with an air bag deactivation system on the front-passenger seat, if the PASSENGER AIR BAG OFF indicator lamp  is not lit.

To make you aware of this danger, a corresponding warning sticker has been affixed on the dashboard and on both sides of the sun visor on the front-passenger side.

Information about recommended child restraint systems is available at any authorized Mercedes-Benz Center.



Example: warning notice on the front-passenger sun visor



Warning symbol for a rearward-facing child restraint system

NEVER use a rearward facing child restraint on a seat protected by an ACTIVE AIR BAG in front of it, DEATH or SERIOUS INJURY to the CHILD can occur.

LATCH-type (ISOFIX) child seat anchors in the rear

WARNING

LATCH-type (ISOFIX) child restraint systems do not offer sufficient protective effect for children whose weight is greater than 48 lbs (22 kg) who are secured using the safety belt integrated in the child restraint system. In the event of an accident, a child might not be restrained correctly. This poses an increased risk of injury or even fatal injury.

If the child weighs more than 48 lbs (22 kg), only use LATCH-type (ISOFIX) child restraint systems with which the child is also secured with the vehicle seat belt. Also secure the

child restraint system with the Top Tether belt, if available.

When installing a child restraint system, be sure to observe the manufacturer's installation instructions and the instructions for correct use of the child restraint system.

 When installing the LATCH-type (ISOFIX) child restraint system, make sure that the seat belt for the center seat does not get trapped. Otherwise, the seat belt could be damaged.

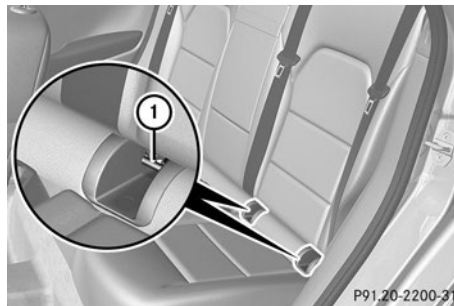

► Install the LATCH-type (ISOFIX) child restraint system. Comply with the child restraint system manufacturer's instructions when installing the LATCH-type (ISOFIX) child restraint system.

LATCH-type (ISOFIX) is a standardized securing system for specially designed child restraint systems on the rear seats. Securing rings ① for two LATCH-type (ISOFIX) child restraint systems are installed on the left and right of the rear seats.

Non-LATCH-type (ISOFIX) child seats may also be used and can be installed using the vehicle's seat belt system. Install the child seat according to the manufacturer's instructions.

Top Tether

Important safety notes

WARNING

If the rear seat backrests are not locked, they could fold forwards in the event of an

accident, heavy braking or sudden changes of direction. As a result, child restraint systems cannot perform their intended protective function. Rear seat backrests that are not locked can also cause additional injuries, e.g. in the event of an accident. This poses an increased risk of injury or even fatal injury. Always lock rear seat backrests after installing a Top Tether belt. Observe the lock verification indicator. Adjust the rear seat backrests so that they are positioned vertically.

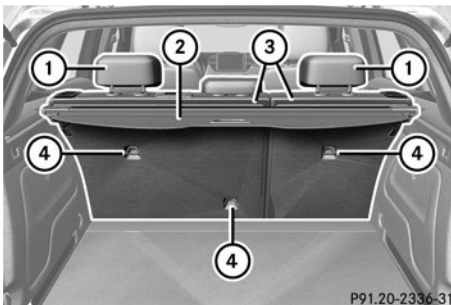

P91.20-2336-31

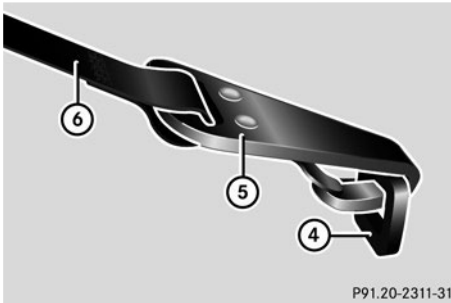

P91.20-2311-31

Top Tether provides an additional connection between a child restraint system, secured with a LATCH-type (ISOFIX) child seat mount, and the rear seat. This helps reduce the risk of injury even further. If the child restraint system is installed with Top Tether, this should always be used.

The Top Tether anchorage points are installed on the rear side of the rear seat backrests.

- ▶ Move head restraint ① upwards.
- ▶ Release rear seat backrest ③ and fold it forwards (▷ page 254).

- ▶ Route Top Tether belt ⑥ under head restraint ① between the two head restraint bars.

- ▶ Hook Top Tether hook ⑤ of Top Tether belt ⑥ into Top Tether anchorage ④.

Make sure that:

- Top Tether hook ⑤ is hooked into Top Tether anchorage ④ as shown.
- Top Tether belt ⑥ is not twisted.
- Top Tether belt ⑥ is routed between rear seat backrest ③ and cargo compartment cover ② if cargo compartment cover ② is installed.

- ▶ Swing back rear seat backrest ③ until it engages.

The red lock verification indicator is no longer visible.

- ▶ Move head restraint ① back down again slightly if necessary (▷ page 96). Make sure that you do not interfere with the correct routing of Top Tether belt ⑥.

- ▶ Install the LATCH-type (ISOFIX) child restraint system with Top Tether. Comply with the manufacturer's installation instructions when doing so. Make sure that Top Tether belt ⑥ is tight.

Child-proof locks

Important safety notes

WARNING

If children are left unsupervised in the vehicle, they could:

- open the doors, thus endangering other people or road users.
- get out and disrupt traffic.
- operate the vehicle's equipment.

Additionally, children could set the vehicle in motion if, for example, they:

- release the parking brake.
- shifting the automatic transmission out of park position **P**
- Start the engine.

There is a risk of an accident and injury.

When leaving the vehicle, always take the SmartKey with you and lock the vehicle. Never leave children or animals unattended in the vehicle. Always keep the SmartKey out of reach of children.

WARNING

If persons, particularly children are subjected to prolonged exposure to extreme heat or cold, there is a risk of injury, possibly even fatal. Never leave children unattended in the vehicle.

WARNING

If children are traveling in the vehicle, they could:

- open doors, thus endangering other people or road users
- exit the vehicle and be caught by oncoming traffic
- operate vehicle equipment and become trapped

There is a risk of an accident and injury.

Always activate the child-proof locks and override feature if children are traveling in the vehicle. When leaving the vehicle, always take the key with you and lock the vehicle. Never leave children unattended in the vehicle.

You can activate the following child-proof locks:

- rear doors (> page 62)
- rear side windows (> page 62)

Child-proof locks for the rear doors

WARNING

Children could open a rear door from inside the vehicle. This could result in serious injuries or an accident. Therefore, when children ride in the rear always secure the rear doors with the child-proof locks.

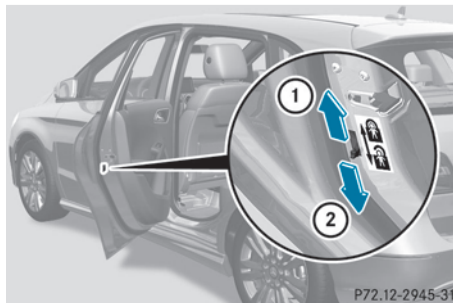

You secure each door individually with the child-proof locks on the rear doors. A door secured with a child-proof lock cannot be opened from inside the vehicle. When the vehicle is unlocked, the door can be opened from the outside.

- ▶ **To activate:** press the child-proof lock lever up in the direction of arrow ①.
- ▶ Make sure that the child-proof locks are working properly.
- ▶ **To deactivate:** press the child-proof lock lever down in the direction of arrow ②.

Override feature for the rear side windows

WARNING

When children ride on the vehicle's rear seats, activate the override switch. Otherwise, the children could be injured, e.g. by trapping themselves in the rear side window.

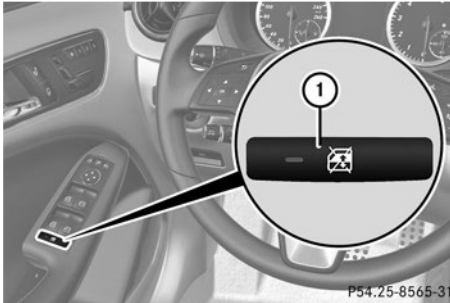

- **To activate/deactivate:** press button ①. If indicator lamp is lit, operation of the rear side windows is disabled. Operation is only possible using the switches in the driver's door. If the indicator lamp is off, operation is possible using the switches in the rear compartment.

Driving safety systems

Overview of driving safety systems

In this section, you will find information about the following driving safety systems:

- ABS (Anti-lock Braking System) (▷ page 70)
- BAS (Brake Assist System) (▷ page 64)
- COLLISION PREVENTION ASSIST (adaptive Brake Assist and distance warning signal) (▷ page 64)
- Adaptive brake lights (▷ page 67)
- ESP® (Electronic Stability Program) (▷ page 67)
- EBD (Electronic Brake force Distribution) (▷ page 69)
- ADAPTIVE BRAKE (▷ page 69)
- STEER CONTROL (▷ page 70)

Important safety notes

If you fail to adapt your driving style or become distracted, the driving safety systems can neither reduce the risk of

accident nor override the laws of physics. Driving safety systems are merely aids designed to assist driving. You are responsible for the distance to the vehicle in front, for vehicle speed and for braking in good time. Always adapt your driving style to suit the prevailing road, weather and traffic conditions and maintain a safe distance from the vehicle in front. Drive carefully.

- i** The driving safety systems described only work as effectively as possible when there is adequate contact between the tires and the road surface. Pay particular attention to the information regarding tires, recommended minimum tire tread depths etc. in the "Wheels and tires" section (▷ page 312).

In wintry driving conditions, always use winter tires (M+S tires) and if necessary, snow chains. Only in this way will the driving safety systems described in this section work as effectively as possible.

ABS (Anti-lock Braking System)

General information

ABS regulates brake pressure in such a way that the wheels do not lock when you brake. This allows you to continue steering the vehicle when braking.

The  ABS warning lamp in the instrument cluster lights up when the ignition is switched on. It goes out when the engine is running.

Important safety notes

- i** Observe the "Important safety notes" section for driving safety systems (▷ page 63).

WARNING

If ABS is faulty, the wheels could lock when braking. The steerability and braking characteristics may be severely impaired. Additionally, further driving safety systems

are deactivated. There is an increased danger of skidding and accidents.

Drive on carefully. Have ABS checked immediately at a qualified specialist workshop.

When ABS is malfunctioning, other systems, including driving safety systems, will also become inoperative. Observe the information on the ABS warning lamp (▷ page 239) and display messages which may be shown in the instrument cluster (▷ page 208).

ABS works from a speed of about 5 mph (8 km/h), regardless of road-surface conditions. ABS works on slippery roads, even if you only brake gently.

Braking

- ▶ **If ABS intervenes:** continue to depress the brake pedal vigorously until the braking situation is over.
- ▶ **To make a full brake application:** depress the brake pedal with full force.

If ABS intervenes when braking, you will feel a pulsing in the brake pedal.

The pulsating brake pedal can be an indication of hazardous road conditions, and functions as a reminder to take extra care while driving.

BAS (Brake Assist System)

General information

BAS operates in emergency braking situations. If you depress the brake pedal quickly, BAS automatically boosts the braking force, thus shortening the stopping distance.

Important safety notes

- ❗ Observe the "Important safety notes" section (▷ page 63).

WARNING

If BAS is malfunctioning, the braking distance in an emergency braking situation is increased. There is a risk of an accident.

In an emergency braking situation, depress the brake pedal with full force. ABS prevents the wheels from locking.

Braking

- ▶ Keep the brake pedal firmly depressed until the emergency braking situation is over. ABS prevents the wheels from locking.

The brakes will function as usual once you release the brake pedal. BAS is deactivated.

COLLISION PREVENTION ASSIST

General notes

COLLISION PREVENTION ASSIST consists of the Adaptive Brake Assist and the distance warning function, which are described in the following.

Distance warning function

Important safety notes

- ❗ Observe the "Important safety notes" section for driving safety systems (▷ page 63).

WARNING

The distance warning function does not react:

- to people or animals
- to oncoming vehicles
- to crossing traffic
- when cornering

Thus, the distance warning function cannot provide a warning in all critical situations. There is a risk of an accident.

Always pay careful attention to the traffic situation and be ready to brake.

⚠ WARNING

The distance warning function cannot always clearly identify objects and complex traffic situations.

In such cases, the distance warning function may:

- give an unnecessary warning
- not give a warning

There is a risk of an accident.

Always pay careful attention to the traffic situation and do not rely solely on the distance warning function.

Function

▶ **To activate/deactivate:** activate or deactivate the distance warning function in the on-board computer (▷ page 200).

Vehicles with a monochrome multifunction display: when the distance warning function is activated, the  symbol appears in the status overview in the multifunction display.

Vehicles with a color multifunction display: when the distance warning function is deactivated, the  symbol appears in the assistance graphic in the multifunction display.

The distance warning function can help you to minimize the risk of a front-end collision with a vehicle ahead or reduce the effects of such a collision. If the distance warning function detects that there is a risk of a collision, you will be warned visually and acoustically. Without your intervention, the distance warning function cannot prevent a collision.

Starting at a speed of around 4 mph (7 km/h), the distance warning function warns you if you rapidly approach a vehicle in front. An intermittent warning tone will then sound, and the  distance warning lamp will light up in the instrument cluster.

▶ Brake immediately in order to increase the distance from the vehicle in front.

or

▶ Take evasive action provided it is safe to do so.

Due to the nature of the system, particularly complicated but non-critical driving conditions may also cause the system to display a warning.

With the help of the radar sensor system, the distance warning function can detect obstacles that are in the path of your vehicle for an extended period of time.

From a speed of around 40 mph (70 km/h), the distance warning function can also react to stationary obstacles, such as stopped or parked vehicles.

If you approach an obstacle and the distance warning function detects a risk of a collision, the system will initially alert you both visually and acoustically.

In particular, the detection of obstacles can be impaired if:

- dirt on the sensors or anything else covering the sensors
- snow or heavy rain
- interference by other radar sources
- there are strong radar reflections, for example in parking garages
- a narrow vehicle traveling in front, e.g. a motorbike
- a vehicle traveling in front on a different line relative to the center of your vehicle

Following damage to the front end of the vehicle, have the configuration and operation of the radar sensor checked at a qualified specialist workshop. This also applies to collisions at low speeds where there is no visible damage to the front of the vehicle.

Adaptive Brake Assist

- ▶ **i** Observe the "Important safety notes" section for driving safety systems (▷ page 63).

⚠ WARNING

Adaptive Brake Assist cannot always clearly identify objects and complex traffic situations. In these cases, Adaptive Brake Assist may not intervene. There is a risk of an accident.

Always pay careful attention to the traffic situation and be ready to brake.

⚠ WARNING

Adaptive Brake Assist does not react:

- to people or animals
- to oncoming vehicles
- to crossing traffic
- to stationary obstacles
- when cornering

As a result, Adaptive Brake Assist may not intervene in all critical conditions. There is a risk of an accident.

Always pay careful attention to the traffic situation and be ready to brake.

Due to the nature of the system, particularly complicated but non-critical driving conditions may also cause Brake Assist to intervene.

Adaptive Brake Assist aids you in braking during hazardous situations at speeds above 4 mph (7 km/h) and uses the radar sensor system to evaluate the traffic situation.

With the help of a sensor system, adaptive Brake Assist can detect obstacles that are in the path of your vehicle for an extended period of time.

Should you approach an obstacle and Adaptive Brake Assist has detected a risk of collision, Adaptive Brake Assist calculates the braking force necessary to avoid a rear-end collision. Should you apply the brakes vigorously, Adaptive Brake Assist will automatically increase the braking force to a level suitable for the traffic conditions.

- ▶ Keep the brake pedal depressed until the emergency braking situation is over. ABS prevents the wheels from locking.

The brakes will work normally again if:

- you release the brake pedal
- there is no longer any danger of a rear-end collision.
- no obstacle is detected in front of your vehicle

Adaptive Brake Assist is then deactivated.

Up to vehicle speeds of around 155 mph (250 km/h), adaptive Brake Assist is capable of reacting to moving objects that have already been recognized as such at least once over the period of observation. Adaptive Brake Assist does not react to stationary obstacles.

If Adaptive Brake Assist is not available due to a malfunction in the radar sensor system, the brake system remains available with full brake boosting effect and BAS.

In particular, the detection of obstacles can be impaired if there is:

- dirt on the sensors or anything else covering the sensors
- snow or heavy rain
- interference by other radar sources
- there are strong radar reflections, for example in parking garages
- a narrow vehicle traveling in front, e.g. a motorbike
- a vehicle traveling in front on a different line relative to the center of your vehicle

Following damage to the front end of the vehicle, have the configuration and operation of the radar sensor checked at a qualified specialist workshop. This also applies to collisions at low speeds where there is no visible damage to the front of the vehicle.

COLLISION PREVENTION ASSIST PLUS**General information**

COLLISION PREVENTION ASSIST PLUS is only available on vehicles with DISTRONIC. COLLISION PREVENTION ASSIST PLUS extends the functionality of COLLISION PREVENTION ASSIST with an automatic

braking function. COLLISION PREVENTION ASSIST PLUS can help you to minimize the risk of a front-end collision with a vehicle ahead or reduce the effects of such a collision. If COLLISION PREVENTION ASSIST PLUS detects that there is a risk of a collision, you will be warned visually and acoustically. In critical situations COLLISION PREVENTION ASSIST PLUS also initiates automatic braking.

Function

► **To activate/deactivate:** activate or deactivate COLLISION PREVENTION ASSIST PLUS in the on-board computer (▷ page 201).

If COLLISION PREVENTION ASSIST PLUS is deactivated, the  symbol appears in the assistance graphics display.

If the driver's seat belt is fastened, COLLISION PREVENTION ASSIST PLUS can brake automatically within a speed range of between 4 mph (7 km/h) and 124 mph (200 km/h).

COLLISION PREVENTION ASSIST PLUS can also react to stationary obstacles with automatic braking within a speed range of between 4 mph (7 km/h) and 19 mph (30 km/h).

In particular, the detection of obstacles can be impaired if:

- dirt on the sensors or anything else covering the sensors
- snow or heavy rain
- interference by other radar sources
- there are strong radar reflections, for example in parking garages
- a narrow vehicle traveling in front, e.g. a motorbike
- a vehicle traveling in front on a different line relative to the center of your vehicle

Following damage to the front end of the vehicle, have the configuration and operation of the radar sensor checked at a qualified specialist workshop. This also applies to

collisions at low speeds where there is no visible damage to the front of the vehicle.

Adaptive brake lights

Adaptive Brake Assist warns following traffic in an emergency braking situation:

- by means of flashing brake lamps
- by activating the hazard warning lamps

If you brake sharply from a speed of more than 70 km/h to a standstill, the hazard warning lamps are activated automatically. If the brakes are applied again, the brake lamps light up continuously. The hazard warning lamps switch off automatically if you travel faster than 10 km/h. You can also switch off the hazard warning lamps using the hazard warning button (▷ page 107).

ESP® (Electronic Stability Program)

General notes

- ❗ Observe the "Important safety notes" section (▷ page 63).

ESP® monitors driving stability and traction, i.e. power transmission between the tires and the road surface.

If ESP® detects that the vehicle is deviating from the direction desired by the driver, one or more wheels are braked to stabilize the vehicle. The engine output is also modified to keep the vehicle on the desired course within physical limits. ESP® assists the driver when pulling away on wet or slippery roads. ESP® can also stabilize the vehicle during braking.

ETS (Electronic Traction System)

- ❗ Observe the "Important safety notes" section (▷ page 63).

ETS traction control is part of ESP®.

ETS brakes the drive wheels individually if they spin. This enables you to pull away and accelerate on slippery surfaces, for example

if the road surface is slippery on one side. In addition, more drive torque is transferred to the wheel or wheels with traction.

ETS remains active when you deactivate ESP®.

Important safety notes

WARNING

If ESP® is malfunctioning, ESP® is unable to stabilize the vehicle. Additionally, further driving safety systems are deactivated. This increases the risk of skidding and an accident.

Drive on carefully. Have ESP® checked at a qualified specialist workshop.

! When testing the electric parking brake on a braking dynamometer, switch off the ignition. Application of the brakes by ESP® may otherwise destroy the brake system.

! Vehicles with 4MATIC: switch off the ignition when the electric parking brake is being tested on a brake dynamometer.



Application of the brakes by ESP® may otherwise destroy the brake system.

! Vehicles with 4MATIC: function or performance tests may only be carried out on a 2-axle dynamometer. Before you operate the vehicle on such a dynamometer, please consult a qualified workshop. You could otherwise damage the drive train or the brake system.

! Do not tow vehicles with 4MATIC with the front or rear axle raised.

When towing your vehicle with the front axle raised, observe the notes on ESP® (> page 307).

ESP® is deactivated if the  ESP® OFF warning lamp in the instrument cluster lights up continuously when the engine is running.

If the  ESP® warning lamp and the  ESP® OFF warning lamp are lit

continuously, ESP® is not available due to a malfunction.

Observe the information on warning lamps (> page 241) and display messages which may be shown in the instrument cluster (> page 208).

i Only use wheels with the recommended tire sizes. Only then will ESP® function properly.

Characteristics of ESP®

General information

If the  ESP warning lamp goes out before beginning the journey, ESP® is automatically active.

If ESP® intervenes, the  ESP® warning lamp flashes in the instrument cluster.

If ESP® intervenes:

- ▶ Do not deactivate ESP® under any circumstances.
- ▶ Only depress the accelerator pedal as far as necessary when pulling away.
- ▶ Adapt your driving style to suit the prevailing road and weather conditions.

ECO start/stop function

The ECO start/stop function switches the engine off automatically when the vehicle stops moving. The engine starts automatically when the driver wants to pull away again. ESP® remains in its previously selected status. **Example:** if ESP® was deactivated before the engine was switched off, ESP® remains deactivated when the engine is switched on again.

Deactivating/activating ESP®

Important safety notes

i Observe the "Important safety notes" section (> page 63).

You can select between the following states of ESP®:

- ESP® is activated.
- ESP® is deactivated.

WARNING

If you deactivate ESP®, ESP® no longer stabilizes the vehicle. There is an increased risk of skidding and an accident.

Only deactivate ESP® in the situations described in the following.

It may be best to deactivate ESP® in the following situations:

- when using snow chains
- in deep snow
- on sand or gravel

i Activate ESP® as soon as the situations described above no longer apply. ESP® will otherwise not be able to stabilize the vehicle if the vehicle starts to skid or a wheel starts to spin.

! Avoid spinning the driven wheels for an extended period with ESP® deactivated. You could otherwise damage the drivetrain.

Deactivating/activating ESP®

You can deactivate or activate ESP® via the on-board computer.

▶ **To deactivate:** (> page 200).

The  ESP® OFF warning lamp in the instrument cluster lights up.

▶ **To activate:** (> page 200).

The  ESP® OFF warning lamp in the instrument cluster goes out.

Characteristics when ESP® is deactivated

If ESP® is deactivated and one or more wheels start to spin, the  ESP® warning lamp in the instrument cluster flashes. In such situations, ESP® will not stabilize the vehicle.

If you deactivate ESP®:

- ESP® no longer improves driving stability.
- engine torque is no longer limited and the drive wheels are able to spin.
The spinning of the wheels results in a cutting action for better traction on loose surfaces.
- traction control is still activated.
- ESP® still provides support when you brake.

EBD (electronic brake force distribution)

General information

EBD monitors and controls the brake pressure on the rear wheels to improve driving stability while braking.

Important safety notes

i Observe the "Important safety notes" section for driving safety systems (> page 63).

WARNING

If EBD has malfunctioned, the rear wheels can still lock, e.g. under full braking. This increases the risk of skidding and an accident. You should therefore adapt your driving style to the different handling characteristics. Have the brake system checked at a qualified specialist workshop.

Observe information regarding indicator and warning lamps (> page 239) as well as display messages (> page 210).

ADAPTIVE BRAKE

ADAPTIVE BRAKE enhances braking safety and offers increased braking comfort. In addition to the braking function, ADAPTIVE BRAKE also has the HOLD function (> page 171) and hill start assist

(▷ page 138). For further information, see Driving tips (▷ page 157).

STEER CONTROL

General information

STEER CONTROL helps you by transmitting a noticeable steering force to the steering wheel in the direction required for vehicle stabilization.

This steering assistance is provided in particular if:

- both right wheels or both left wheels are on a wet or slippery road surface when you brake.
- the vehicle starts to skid.

Important safety notes

If ESP® is malfunctioning, you will not receive steering support from STEER CONTROL. Power steering will, however, continue to function.

Theft deterrent locking system

Immobilizer

The immobilizer prevents your vehicle from being started without the correct SmartKey.

- ▶ **To activate:** remove the SmartKey from the ignition lock.
- ▶ **To deactivate:** switch on the ignition.

When leaving the vehicle, always take the SmartKey with you and lock the vehicle. The engine can be started by anyone with a valid SmartKey that is left inside the vehicle.

- ❗ The immobilizer is always deactivated when you start the engine.

In the event that the engine cannot be started when the starter battery is fully charged, the immobilizer may be faulty. Contact an authorized Mercedes-Benz Center or call 1-800-FOR-MERCEdes (in the USA) or 1-800-387-0100 (in Canada).

ATA (anti-theft alarm system)



- ▶ **To arm:** lock the vehicle with the SmartKey. Indicator lamp ① flashes. The alarm system is armed after approximately 15 seconds.

- ▶ **To disarm:** unlock the vehicle with the SmartKey.

or

- ▶ Insert the SmartKey into the ignition lock.



A visual and audible alarm is triggered if the alarm system is armed and you open:

- the vehicle with the mechanical key
- a door
- the tailgate
- the hood

- ▶ **To stop the alarm:** insert the SmartKey into the ignition lock.

The alarm is switched off.

or

- ▶ Press the  or  button on the SmartKey.

The alarm is switched off.

The alarm is not switched off, even if you close the open door that triggered it, for example.

i If the alarm stays on for more than 30 seconds, the mbrace emergency call system automatically sends a message to the Customer Assistance Center by text message or data connection. The emergency call system sends the message provided that:

- you have subscribed to the mbrace service.
- the mbrace service has been activated properly.
- the necessary mobile phone network is available.

Useful information	74
SmartKey	74
Doors	79
Cargo compartment	81
Side windows	83
Panorama roof with power tilt/ sliding panel	86

Useful information

- i** This Operator's Manual describes all models and all standard and optional equipment of your vehicle available at the time of publication of the Operator's Manual. Country-specific differences are possible. Please note that your vehicle may not be equipped with all features described. This also applies to safety-related systems and functions.
- i** Read the information on qualified specialist workshops: (> page 25).

SmartKey

Important safety notes

WARNING

If children are left unsupervised in the vehicle, they could:

- open the doors, thus endangering other people or road users.
 - get out and disrupt traffic.
 - operate the vehicle's equipment.
- Additionally, children could set the vehicle in motion if, for example, they:
- release the parking brake.
 - shifting the automatic transmission out of park position **P**
 - Start the engine.

There is a risk of an accident and injury.

When leaving the vehicle, always take the SmartKey with you and lock the vehicle. Never leave children or animals unattended in the vehicle. Always keep the SmartKey out of reach of children.

WARNING

If persons, particularly children are subjected to prolonged exposure to extreme heat or cold, there is a risk of injury, possibly even fatal. Never leave children unattended in the vehicle.

WARNING

If you attach heavy or large objects to the SmartKey, the SmartKey could be unintentionally turned in the ignition lock. This could cause the engine to be switched off. There is a risk of an accident.

Do not attach any heavy or large objects to the SmartKey. Remove any bulky key rings before inserting the SmartKey into the ignition lock.



- !** Keep the SmartKey away from strong magnetic fields. Otherwise, the remote control function could be affected. Strong magnetic fields can occur in the vicinity of powerful electrical installations.

Do not keep the SmartKey:

- with electronic devices, e.g. a mobile phone or another SmartKey
- with metallic objects, e.g. coins or metal foil
- inside metallic objects, e.g. a metal case

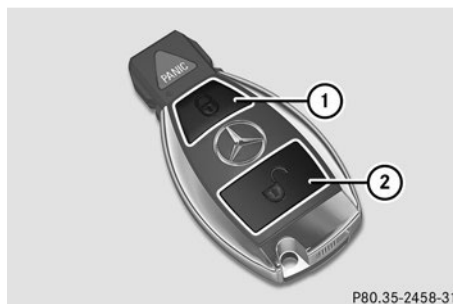
SmartKey functions



- ①  To lock the vehicle
- ②  To unlock the vehicle

► **To unlock centrally:** press button ②.

If you do not open the vehicle within approximately 40 seconds of unlocking:

- the vehicle is locked again.
- the theft deterrent locking system is armed again.

- ▶ **To lock centrally:** press button ①.

The SmartKey centrally locks/unlocks:





- the doors
- the tailgate
- the fuel filler flap

The turn signals flash once when unlocking and three times when locking.

- ① When it is dark, the surround lighting also comes on if it is activated in the on-board computer (▷ page 204).
- ① You can also set an audible signal to confirm that the vehicle has been locked. The audible signal can be activated and deactivated using the on-board computer (▷ page 205).





Changing the settings of the locking system

You can change the settings of the locking system. When you then unlock the vehicle only the driver's door and the fuel filler flap are unlocked. This is useful if you frequently travel on your own.

- ▶ **To change the setting:** press and hold down the  and  buttons simultaneously for approximately six seconds until the battery check lamp (▷ page 76) flashes twice.
- ① If the setting of the locking system is changed within the signal range of the vehicle, pressing the  or  button:

- locks or
- unlocks the vehicle

The SmartKey now functions as follows:

- ▶ **To unlock the driver's door:** press the  button once.
- ▶ **To unlock centrally:** press the  button twice.
- ▶ **To lock centrally:** press the  button.
- ▶ **To restore the factory settings:** press and hold down the  and  buttons

simultaneously for approximately six seconds until the battery check lamp flashes twice (▷ page 76).



Mechanical key

General notes

If the vehicle can no longer be unlocked with the SmartKey, use the mechanical key.

If you use the mechanical key to unlock and open the driver's door, the anti-theft alarm system will be triggered (▷ page 70).

There are several ways to turn off the alarm:

- ▶ Press the  or  button on the SmartKey.

or

- ▶ Insert the SmartKey into the ignition lock.

If you unlock the vehicle using the mechanical key, the fuel filler flap will not be unlocked automatically.

- ▶ **To unlock the fuel filler flap:** insert the SmartKey into the ignition lock.

Removing the mechanical key

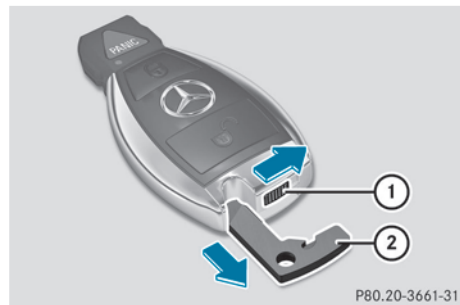

- ▶ Push release catch ① in the direction of the arrow and at the same time remove mechanical key ② from the SmartKey.

For further information about:

- unlocking the driver's door (▷ page 81)
- unlocking the cargo compartment (▷ page 82)
- locking the vehicle (▷ page 81)

SmartKey battery

Important safety notes

WARNING

Batteries contain toxic and corrosive substances. If batteries are swallowed, it can result in severe health problems. There is a risk of fatal injury.



Keep batteries out of the reach of children. If a battery is swallowed, seek medical attention immediately.

The SmartKey batteries contain perchlorate material, which may require special handling and regard for the environment. National guidelines must be observed during disposal. In California, see www.dtsc.ca.gov/HazardousWaste/Perchlorate/index.cfm.

Mercedes-Benz recommends that you have the batteries replaced at a qualified specialist workshop.



Checking the battery



- ▶ Press the  or  button. The battery is working properly if battery check lamp ① lights up briefly.

The battery is discharged if battery check lamp ① does not light up briefly.

- ▶ Change the battery (▷ page 76).

i If the SmartKey battery is checked within the signal reception range of the vehicle, pressing the  or  button:

- locks or
- unlocks the vehicle

i You can get a battery at any qualified specialist workshop.

Replacing the battery

You require a CR 2025 3 V cell battery.

- ▶ Take the mechanical key out of the SmartKey (▷ page 75).

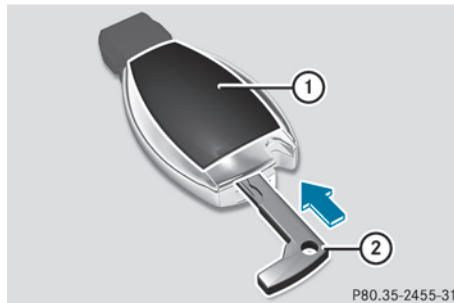



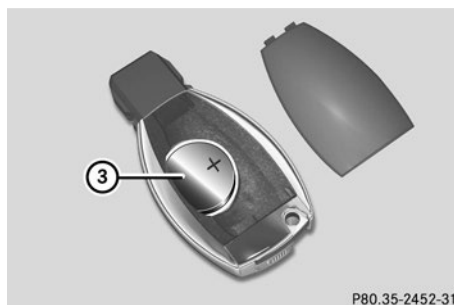

- ▶ Press mechanical key ② into the opening in the SmartKey in the direction of the arrow until battery tray cover ① opens. When doing so, do not hold cover ① shut.
- ▶ Remove battery tray cover ①.



- ▶ Repeatedly tap the SmartKey against your palm until battery ③ falls out.
- ▶ Insert the new battery with the positive terminal facing upwards. Use a lint-free cloth to do so.
- ▶ Make sure that the surface of the battery is free from lint, grease and all other forms of contamination.
- ▶ Insert the front tabs of battery tray cover ① and then press to close it.
- ▶ Insert the mechanical key into the SmartKey.
- ▶ Check the function of all SmartKey buttons on the vehicle.

Problems with the SmartKey

Problem	Possible causes/consequences and ► Solutions
<p>You cannot lock or unlock the vehicle using the SmartKey.</p>	<p>The SmartKey battery is discharged or nearly discharged.</p> <ul style="list-style-type: none"> ► Try again to lock/unlock the vehicle using the remote control function of the SmartKey. Point the tip of the SmartKey at the driver's door handle from close range and press the  or  button. <p>If this does not work:</p> <ul style="list-style-type: none"> ► Check the SmartKey battery and replace it if necessary (▷ page 76). ► Unlock (▷ page 81) or lock (▷ page 81) the vehicle using the mechanical key. <p>There is interference from a powerful source of radio waves.</p> <ul style="list-style-type: none"> ► Try again to lock/unlock the vehicle using the remote control function of the SmartKey. Point the tip of the SmartKey at the driver's door handle from close range and press the  /  button. <p>The SmartKey is faulty.</p> <ul style="list-style-type: none"> ► Unlock (▷ page 81) or lock (▷ page 81) the vehicle using the mechanical key. ► Have the SmartKey checked at a qualified specialist workshop.
<p>You have lost a SmartKey.</p>	<ul style="list-style-type: none"> ► Have the SmartKey deactivated at a qualified specialist workshop. ► Report the loss immediately to the vehicle insurers. ► If necessary, have the locks changed as well.
<p>You have lost the mechanical key.</p>	<ul style="list-style-type: none"> ► Report the loss immediately to the vehicle insurers. ► If necessary, have the locks changed as well.

Problem	Possible causes/consequences and ► Solutions
The engine cannot be started using the SmartKey.	<p>The on-board voltage is too low.</p> <ul style="list-style-type: none"> ► Switch off non-essential consumers, e.g. seat heating or interior lighting, and try to start the engine again. <p>If this does not work:</p> <ul style="list-style-type: none"> ► Check the starter battery and charge it if necessary (► page 299). <p>or</p> <ul style="list-style-type: none"> ► Jump-start the vehicle (► page 303). <p>or</p> <ul style="list-style-type: none"> ► Consult a qualified specialist workshop.
The engine cannot be started using the SmartKey.	<p>The steering lock is mechanically blocked.</p> <ul style="list-style-type: none"> ► Remove the SmartKey and reinsert it into the ignition lock. While doing this, turn the steering wheel in both directions.

Doors

Important safety notes

WARNING

If children are left unsupervised in the vehicle, they could:

- open the doors, thus endangering other people or road users.
- get out and disrupt traffic.
- operate the vehicle's equipment.

Additionally, children could set the vehicle in motion if, for example, they:

- release the parking brake.
- shifting the automatic transmission out of park position **P**
- Start the engine.

There is a risk of an accident and injury.

When leaving the vehicle, always take the SmartKey with you and lock the vehicle. Never leave children or animals unattended in the vehicle. Always keep the SmartKey out of reach of children.

WARNING

If persons, particularly children are subjected to prolonged exposure to extreme heat or cold, there is a risk of injury, possibly even fatal. Never leave children unattended in the vehicle.

You should preferably place luggage or loads in the cargo compartment. Observe the loading guidelines (► page 250).

Unlocking and opening doors from the inside

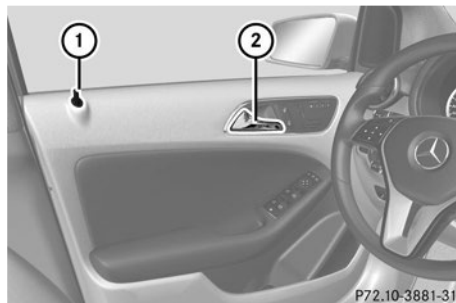

P72.10-3881-31

- ▶ **To unlock a front door:** pull door handle ②.
Locking knob ① pops up.
The door is unlocked and can be opened.
- ▶ **To open a front door:** pull door handle ②.
- ▶ **To unlock a rear door:** pull up locking knob ①.
The door is unlocked and can be opened.
- ▶ **To open a rear door:** pull door handle ②.

You can open a door from inside the vehicle even if it has been locked. You can open the rear doors from inside the vehicle unless they are secured by the child-proof lock (▷ page 62).

If the vehicle has previously been locked with the SmartKey, opening a door from the inside will trigger the anti-theft alarm system. Switch off the alarm (▷ page 70).

Centrally locking and unlocking the vehicle from the inside

You can centrally lock or unlock the vehicle from the inside. This can be useful if you wish to lock the vehicle before pulling away, for example.

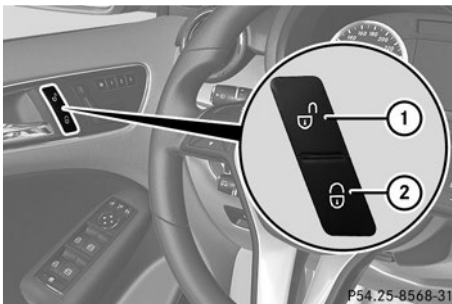

- ▶ **To unlock:** press button ①.
- ▶ **To lock:** press button ②.
The vehicle locks when all the doors and the tailgate are closed.

Meanwhile, the fuel filler flap will not be locked or unlocked.

You cannot unlock the vehicle centrally from the inside if the vehicle has been locked with the SmartKey.

You can open a door from inside the vehicle even if it has been locked. You can open the rear doors from inside the vehicle unless they are secured by the child-proof lock (▷ page 62).

If the vehicle has previously been locked with the SmartKey, opening a door from the inside will trigger the anti-theft alarm system. Switch off the alarm (▷ page 70).

If the vehicle has been locked using the locking button for the central locking, or has been locked automatically, and a door is opened from the inside:

- the vehicle will be fully unlocked if it had previously been fully unlocked
- only the door which has been opened from the inside is unlocked if only the driver's door had been previously unlocked

Automatic locking feature

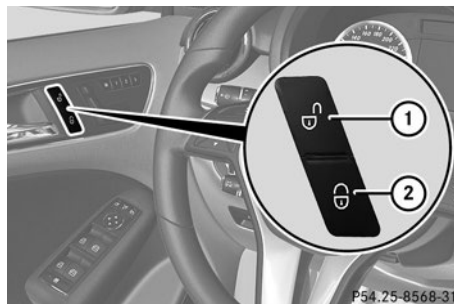

- ▶ **To deactivate:** press and hold button ① for about five seconds until a tone sounds.
- ▶ **To activate:** press and hold button ② for about five seconds until a tone sounds.

i If you press one of the two buttons and do not hear a tone, the relevant setting has already been selected.

The vehicle is locked automatically when the ignition is switched on and the wheels are turning.

You could therefore lock yourself out if:

- the vehicle is being pushed.
- the vehicle is being towed.
- the vehicle is on a roller dynamometer.

You can also switch the automatic locking function on and off using the on-board computer (▷ page 205).

Unlocking the driver's door (mechanical key)

If the vehicle can no longer be unlocked with the SmartKey, use the mechanical key.

If you use the mechanical key to unlock and open the driver's door, the anti-theft alarm system will be triggered (▷ page 70).

- ▶ Take the mechanical key out of the SmartKey (▷ page 75).
- ▶ Insert the mechanical key into the lock of the driver's door as far as it will go.

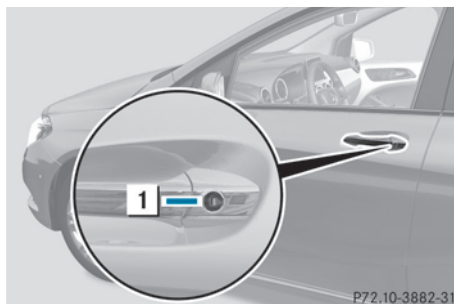

- ▶ Turn the mechanical key counter-clockwise to position **1**.
The door is unlocked.
- ▶ Turn the mechanical key back and remove it.
- ▶ Insert the mechanical key into the SmartKey.

Locking the vehicle (mechanical key)

If the vehicle can no longer be locked with the SmartKey, use the mechanical key.

- ▶ Open the driver's door.
- ▶ Close the front-passenger door, the rear doors and the tailgate.
- ▶ Press the locking button (▷ page 80).
- ▶ Check whether the locking knobs on the front-passenger door and the rear doors are still visible. Press down the locking knobs manually, if necessary (▷ page 79).
- ▶ Close the driver's door.
- ▶ Take the mechanical key out of the SmartKey (▷ page 75).
- ▶ Insert the mechanical key into the lock of the driver's door as far as it will go.

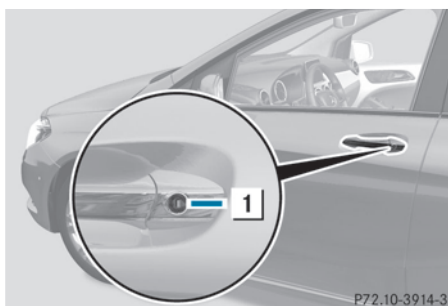

- ▶ Turn the mechanical key clockwise as far as it will go to position **1**.
- ▶ Turn the mechanical key back and remove it.
- ▶ Make sure that the doors and the tailgate are locked.
- ▶ Insert the mechanical key into the SmartKey.

i If you lock the vehicle as described above, the fuel filler flap is not locked. The anti-theft alarm system is not armed.

Cargo compartment

Important safety notes

⚠ WARNING

Combustion engines emit poisonous exhaust gases such as carbon monoxide. If the tailgate is open when the engine is running,

particularly if the vehicle is moving, exhaust fumes could enter the passenger compartment. There is a risk of poisoning. Turn off the engine before opening the tailgate. Never drive with the tailgate open.

WARNING

If persons, particularly children are subjected to prolonged exposure to extreme heat or cold, there is a risk of injury, possibly even fatal. Never leave children unattended in the vehicle.

! The tailgate swings upwards and to the rear when opened. Therefore, make sure that there is sufficient clearance above and behind the tailgate.

i The opening dimensions of the tailgate can be found in the "Vehicle data" section (▷ page 353).

You should preferably place luggage or loads in the cargo compartment. Observe the loading guidelines (▷ page 250).

Do not leave the SmartKey in the cargo compartment. You could otherwise lock yourself out.

The tailgate can be:

- opened and closed manually from outside
- unlocked from inside with the mechanical key

Opening/closing from outside

Opening

- ▶ Press the  button on the SmartKey.

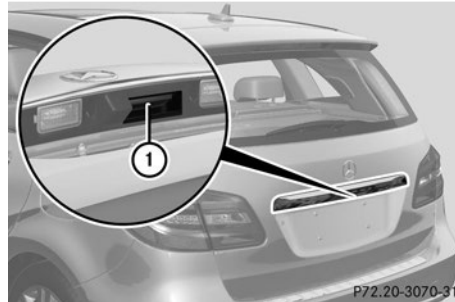

- ▶ Pull handle ①.
- ▶ Raise the tailgate.

Closing

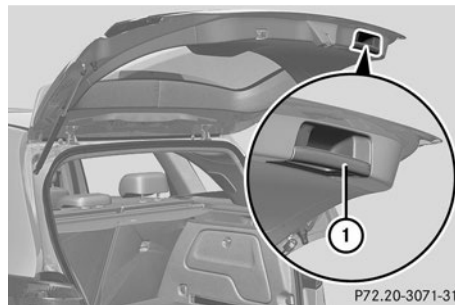

- ▶ Pull the tailgate down using handle ①.
- ▶ Allow the tailgate to drop into the lock.
- ▶ If necessary, lock the vehicle with the  button on the SmartKey.

Tailgate emergency release

If the tailgate can no longer be opened from outside the vehicle, use the emergency release on the inside of the tailgate.

! The tailgate swings upwards and to the rear when opened. Therefore, make sure that there is sufficient clearance above and behind the tailgate.

i The opening dimensions of the tailgate can be found in the "Vehicle data" section (▷ page 353).

You can reach the emergency release via the cargo compartment. Fold the rear backrests forward (▷ page 254).

- ▶ Take the mechanical key out of the SmartKey (▷ page 75).

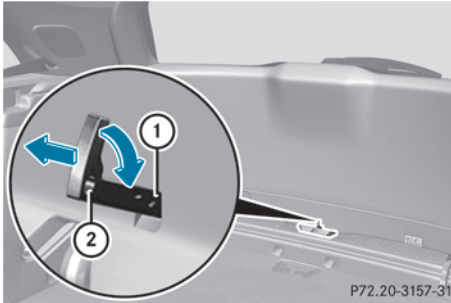

- ▶ Insert mechanical key ② into the opening in paneling ①.
 - ▶ Turn mechanical key ② 90° clockwise.
 - ▶ Push mechanical key ② in the direction of the arrow and open the tailgate.
- i** When you lock the vehicle (▷ page 81), the cargo compartment is also locked.

Side windows

Important safety notes

WARNING

While opening the side windows, body parts in the closing area could become trapped. There is a risk of injury.

Make sure that no body parts are in close proximity during the closing procedure. If somebody becomes trapped, release the switch or press the switch to open the side window again.

WARNING

If children operate the side windows they could become trapped, particularly if they are left unsupervised. There is a risk of injury.

Activate the override feature for the rear side windows. When leaving the vehicle, always

take the SmartKey with you and lock the vehicle. Never leave children unsupervised in the vehicle.

Side window reversing feature

The side windows are equipped with an automatic reversing feature. If a solid object blocks or restricts a side window during the closing process, the side window opens again automatically. However, the automatic reversing feature is only an aid and does not relieve you of the responsibility of paying attention when closing a side window.

WARNING

The reversing feature does not react:

- to soft, light and thin objects, e.g. small fingers
- over the last 1/6 in(4 mm) of the closing movement
- during resetting
- when closing the side window again manually immediately after automatic reversing

This means that the reversing feature cannot prevent someone being trapped in these situations. There is a risk of injury.

Make sure that no body parts are in close proximity during the closing procedure. If someone becomes trapped, press the switch to open the side window again.

Opening and closing the side windows

The switches for all side windows are located on the driver's door. There is also a switch on each door for the corresponding side window. The switches on the driver's door take precedence.

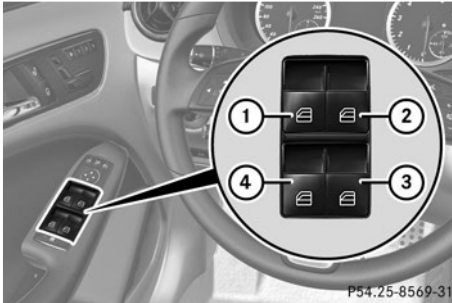

- ① Front left
- ② Front right
- ③ Rear right
- ④ Rear left

i When the override feature for the side windows is activated (> page 62), the side windows cannot be operated from the rear.

- ▶ Turn the SmartKey to position **1** or **2** in the ignition lock.
- ▶ **To open:** press the corresponding switch.
- ▶ **To open fully:** press the corresponding switch beyond the point of resistance. Automatic closing is started.
- ▶ **To close:** pull the corresponding switch.
- ▶ **To close fully:** pull the corresponding switch beyond the pressure point. Automatic closing is started.
- ▶ **To interrupt the automatic opening/closing:** press/pull the corresponding switch again.

i If you press the switch beyond the point of resistance, an automatic opening/closing process is started in the corresponding direction. You can stop automatic operation by operating the switch again.



i You can continue to operate the side windows after you switch off the engine or remove the SmartKey. This function is available for up to five minutes or until the driver's or front-passenger door is opened.

Convenience opening

You can ventilate the vehicle before you start driving. To do this, the SmartKey is used to carry out the following functions simultaneously:

- unlock the vehicle
- open the side windows
- open the panorama roof with power tilt/sliding panel and the roller sunblinds

i The convenience opening feature can only be operated using the SmartKey. The SmartKey must be close to the driver's door handle.

- ▶ Point the tip of the SmartKey at the driver's door handle.
- ▶ Press and hold the  button until the side windows and the panorama roof with power tilt/sliding panel are in the desired position. If the roller sunblinds of the panorama roof with power tilt/sliding panel are closed, the roller sunblinds are opened first.
- ▶ Press and hold the  button again until the panorama roof with power tilt/sliding panel is in the desired position.
- ▶ **To interrupt convenience opening:** release the  button.

Convenience closing feature

WARNING



When the convenience closing feature is operating, parts of the body could become trapped in the closing area of the side window and the sliding sunroof. There is a risk of injury.

Observe the complete closing procedure when the convenience closing feature is operating. Make sure that no body parts are in close proximity during the closing procedure.



When you lock the vehicle, you can simultaneously:

- close the side windows
- close the panorama roof with power tilt/sliding panel

On vehicles with a panorama roof with power tilt/sliding panel, you can then close the roller sunblinds.

- ▶  The SmartKey must be close to the driver's door handle.
- ▶ Point the tip of the SmartKey at the driver's door handle.
- ▶ Press and hold the  button until the side windows and the panorama roof with power tilt/sliding panel are fully closed.
- ▶ Make sure that all the side windows and the panorama roof with power tilt/sliding panel are closed.

On vehicles with a panorama roof with power tilt/sliding panel:

- ▶ Press and hold the  button again until the roller sunblinds of the panorama roof with power tilt/sliding panel close.
- ▶ **To interrupt convenience closing:** release the  button.

Resetting the side windows

You must reset each side window if:

- the side window opens again slightly after being closed fully.
- the side window can no longer be fully opened or closed.
- ▶ Close all the doors.
- ▶ Turn the SmartKey to position **1** or **2** in the ignition lock.
- ▶ Pull the corresponding switch on the door control panel until the side window is completely closed (▷ page 83).
- ▶ Hold the switch for an additional second.

If the side window opens again slightly:

- ▶ Immediately pull the corresponding switch on the door control panel until the side window is completely closed (▷ page 83).
- ▶ Hold the switch for an additional second.
- ▶ If the corresponding side window remains closed after the button has been released, the side window has been reset correctly. If this is not the case, repeat the steps above again.

Problems with the side windows

WARNING

If you close a side window again immediately after it has been blocked or reset, the side window closes with increased or maximum force. The reversing feature is then not active. Parts of the body could be trapped in the closing area in the process. This poses an increased risk of injury or even fatal injury.

Make sure that no parts of the body are in the closing area. To stop the closing process, release the switch or push the switch again to reopen the side window.

Problem: a side window cannot be closed because it is blocked by objects, e.g. leaves in the window guide.

- ▶ Remove the objects.
- ▶ Close the side window.

Problem: a side window cannot be closed and you cannot see the cause. If a side window is obstructed during closing and reopens again slightly:

- ▶ Immediately after the window blocks, pull the corresponding switch again until the side window has closed. The side window is closed with increased force.

If a side window is obstructed again during closing and reopens again slightly:

- ▶ Immediately after the window blocks, pull the corresponding switch again until the side window has closed.
The side window is closed without the anti-entrapment feature.

Panorama roof with power tilt/sliding panel

Important safety notes

In the following section, the term "sliding sunroof" refers to the panorama roof with power tilt/sliding panel.

WARNING

While opening and closing the sliding sunroof, body parts in close proximity could become trapped. There is a risk of injury.

Make sure that no body parts are in close proximity during the opening and closing procedures.

If somebody becomes trapped:

- release the switch immediately, or
- during automatic operation, push the switch briefly in any direction

The opening or closing procedure will be stopped.

WARNING

If children operate the sliding sunroof they could become trapped, particularly if they are left unsupervised. There is a risk of injury.

When leaving the vehicle, always take the SmartKey with you and lock the vehicle. Never leave children unsupervised in the vehicle.

- ❗ Only open the sliding sunroof if it is free of snow and ice. Otherwise, malfunctions may occur.

Do not allow anything to protrude from the sliding sunroof. Otherwise, the seals could be damaged.

- ❗ The weather can change abruptly. It could start to rain or snow. Make sure that the sliding sunroof is closed when you leave the vehicle. The vehicle electronics can be damaged if water enters the vehicle interior.

- i Resonance noises can occur in addition to the usual airflow noises when the sliding sunroof is open. They are caused by minor pressure fluctuations in the vehicle interior. Change the position of the sliding sunroof or open a side window slightly to reduce or eliminate these noises.

Sliding sunroof reversing feature

The sliding sunroof is equipped with an automatic reversing feature. If a solid object blocks or restricts the sliding sunroof during the closing process, the sliding sunroof opens again automatically. However, the automatic reversing feature is only an aid and does not relieve you of the responsibility of paying attention when closing the sliding sunroof.

WARNING

The reversing feature does not react:

- to soft, light and thin objects, e.g. small fingers
- over the last 1/6 in(4 mm) of the closing movement
- during resetting
- when closing the sliding sunroof again manually immediately after automatic reversing

This means that the reversing feature cannot prevent someone being trapped in these situations. There is a risk of injury.

Make sure that no body parts are in close proximity during the closing procedure.

If somebody becomes trapped:

- release the switch immediately, or
- during automatic operation, push the switch briefly in any direction

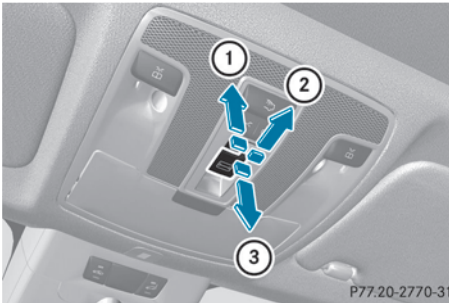

The closing process is stopped.

Operating the sliding sunroof



Overhead control panel

- ① To raise
- ② To open
- ③ To close/lower

- ▶ Turn the SmartKey to position **1** or **2** in the ignition lock.
- ▶ Make sure that the roller sunblinds are open.
- ▶ Press or pull the  switch in the corresponding direction.
- ▶ **i** If you press the  switch beyond the point of resistance, an automatic opening/closing process is started in the corresponding direction. You can stop automatic operation by operating the switch again.

The automatic raising feature is available only when the sliding sunroof is closed.

- ▶ **i** You can continue to operate the sliding sunroof after switching off the engine or removing the SmartKey from the ignition lock. This function remains active for five minutes or until you open a front door.

Operating the roller sunblinds for the sliding sunroof

Important safety notes

WARNING

When opening or closing the roller sunblind, parts of the body could be trapped between

the roller sunblind and the frame or sliding sunroof. There is a risk of injury.

When opening or closing make sure that no parts of the body are in the sweep of the roller sunblind.

If somebody becomes trapped:

- release the switch immediately, or
- during automatic operation, push the switch briefly in any direction

The opening or closing procedure will be stopped.

The roller sunblinds shield the vehicle interior from sunlight. The two roller sunblinds can only be opened and closed together when the sliding sunroof is closed.

Roller sunblind reversing feature

The roller sunblinds are equipped with an automatic reversing feature. If a solid object blocks or restricts a roller sunblind during the closing process, the roller sunblind opens again automatically. However, the automatic reversing feature is only an aid and does not relieve you of the responsibility of paying attention when closing the roller sunblinds.

WARNING

The reversing feature does not react:

- to soft, light and thin objects, e.g. small fingers
- when closing the roller sunblind again manually immediately after automatic reversing

This means that the reversing feature cannot prevent someone being trapped in these situations. There is a risk of injury.

When closing make sure that no parts of the body are in the sweep of the roller sunblind.

If somebody becomes trapped:

- release the switch immediately, or
- during automatic operation, push the switch briefly in any direction

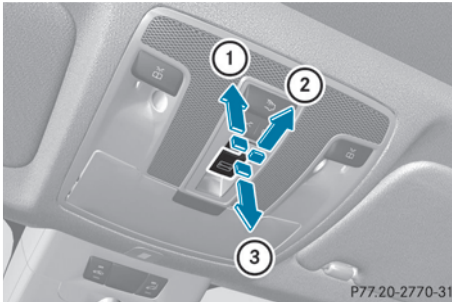

The closing process is stopped.

Opening and closing





Overhead control panel



- ① To open
- ② To open
- ③ To close

- ▶ Turn the SmartKey to position **1** or **2** in the ignition lock.
- ▶ Press or pull the  switch in the corresponding direction.
- ▶ **i** If you press the  switch beyond the point of resistance, an automatic opening/closing process is started in the corresponding direction. You can stop automatic operation by operating the switch again.

Resetting the sliding sunroof and the roller sunblinds

If the sliding sunroof or the roller sunblinds do not move smoothly, reset the sliding sunroof and the roller sunblinds:

- ▶ Turn the SmartKey to position **1** or **2** in the ignition lock.
- ▶ Press the  switch to the point of resistance in the direction of arrow **②** and hold it until the sliding sunroof has opened about 4 in (10 cm).
- ▶ Pull the  switch repeatedly to the point of resistance in the direction of arrow **③** until the sliding sunroof is fully closed.
- ▶ Keep the  switch pulled for an additional second.

- ▶ Press the  switch to the point of resistance in the direction of arrow **②** and hold it until the roller sunblinds are open about 4 in (10 cm).
- ▶ Pull the  switch repeatedly to the point of resistance in the direction of arrow **③** until the roller sunblinds are fully closed.
- ▶ Keep the  switch pulled for an additional second.
- ▶ Make sure that the sliding sunroof (▷ page 87) and the roller sunblinds (▷ page 88) can be fully opened and closed again.
- ▶ If this is not the case, repeat the steps above again.

Problems with the sliding sunroof

WARNING

If you do not reset the sliding sunroof after a malfunction or voltage supply interruption, then the backing up function will malfunction or not work. The sliding sunroof closes with increased or maximum force. Parts of the body could be trapped in the closing area in the process. This poses an increased risk of injury or even fatal injury.

In such or similar situations always make sure that no parts of the body are in the closing area. Always reset the sliding sunroof after a malfunction or voltage supply interruption.

- ▶ **i** If the sliding sunroof still cannot be opened or closed as a result of a malfunction, contact a qualified specialist workshop.

Problem: the sunroof cannot be closed and you cannot see the cause. If the sliding sunroof is obstructed during closing and reopens again slightly:

- ▶ Immediately after it blocks, pull the  switch down again to the point of

resistance until the sliding sunroof is closed

The sliding sunroof is closed with increased force.

If the sliding sunroof is obstructed again during closing and then reopens slightly:

- ▶ Immediately after it blocks, pull the  switch down again to the point of resistance until the sliding sunroof is closed
The sliding sunroof is closed without the anti-entrapment feature.

Useful information	92
Correct driver's seat position	92
Seats	93
Steering wheel	98
Mirrors	99
Memory functions	101

Useful information

- i** This Operator's Manual describes all models and all standard and optional equipment of your vehicle available at the time of publication of the Operator's Manual. Country-specific differences are possible. Please note that your vehicle may not be equipped with all features described. This also applies to safety-related systems and functions.
- i** Read the information on qualified specialist workshops: (▷ page 25).

Correct driver's seat position

⚠ WARNING

You could lose control of your vehicle if you do the following while driving:

- adjust the driver's seat, head restraint, steering wheel or mirrors
- fasten the seat belt

There is a risk of an accident.

Adjust the driver's seat, head restraint, steering wheel and mirror and fasten your seat belt before starting the engine.



Observe the safety guidelines on seat adjustment (▷ page 93).

- ▶ Make sure that seat ③ is adjusted properly.
 - Manual seat adjustment (▷ page 94)
 - Electrical seat adjustment (▷ page 95)
 When adjusting the seat, make sure that:
 - you are as far away from the driver's air bag as possible.
 - you are sitting in a normal upright position.
 - you can fasten the seat belt properly.
 - you have moved the backrest to an almost vertical position.
 - you have set the seat cushion angle so that your thighs are gently supported.
 - you can depress the pedals properly.
- ▶ Check whether the head restraint is adjusted properly (▷ page 95).

When doing so, make sure that you have adjusted the head restraint so that the back of your head is supported at eye level by the center of the head restraint.

Observe the safety guidelines on steering wheel adjustment (▷ page 98).

- ▶ Make sure that steering wheel ① is adjusted properly.

Adjusting the steering wheel (▷ page 98)

When adjusting the steering wheel, make sure that:

 - you can hold the steering wheel with your arms slightly bent.
 - you can move your legs freely.
 - you can see all the displays in the instrument cluster clearly.

Observe the safety guidelines for seat belts (▷ page 52).

- ▶ Check whether you have fastened seat belt ② properly (▷ page 53).

The seat belt should:

- fit snugly across your body
 - be routed across the middle of your shoulder
 - be routed in your pelvic area across the hip joints
- ▶ Before starting off, adjust the rear-view mirror and the exterior mirrors (> page 99) in such a way that you have a good view of road and traffic conditions.
- ▶ **Vehicles with a memory function:** save the seat and exterior mirror settings (> page 101).

Seats

Important safety notes

WARNING

Children could become trapped if they adjust the seats, particularly when unattended. There is a risk of injury.

When leaving the vehicle, always take the SmartKey with you and lock the vehicle. Never leave children unsupervised in the vehicle.

WARNING

You could lose control of your vehicle if you do the following while driving:

- adjust the driver's seat, head restraint, steering wheel or mirrors
- fasten the seat belt

There is a risk of an accident.

Adjust the driver's seat, head restraint, steering wheel and mirror and fasten your seat belt before starting the engine.

WARNING

If you adjust the seat height carelessly, you or other vehicle occupants could be trapped and thereby injured. Children in particular could accidentally press the electrical seat adjustment buttons and become trapped. There is a risk of injury.

While moving the seats, make sure that your hands or other body parts do not get under the lever assembly of the seat adjustment system.

WARNING

When you adjust a seat, you or other vehicle occupants could become trapped, e.g. on the seat guide rail. There is a risk of injury.

Make sure when adjusting a seat that no one has any body parts in the sweep of the seat.

WARNING

The seat belt does not offer the intended level of protection if the backrest is not in the upright position. When braking or in the event of an accident, you could slide underneath the seat belt and sustain abdomen or neck injuries, for example. This poses an increased risk of injury or even fatal injury.

Adjust the seat properly before beginning your journey. Always make sure that the seat is in the upright position.

WARNING

If head restraints are not installed and adjusted correctly, they cannot provide protection as intended. There is an increased risk of injury in the head and neck area, e.g. in the event of an accident or when braking.

Always drive with the head restraints installed. Before driving off, make sure for every vehicle occupant that the center of the head restraint supports the back of the head at about eye level.

WARNING

According to accident statistics, children are safer when properly restrained on the rear seats than on the front-passenger seat. Thus, we strongly recommend that children be placed in the rear seat whenever possible. Regardless of seating position, children 12 years old and under must be seated and properly secured in an appropriately sized child restraint system or booster seat

recommended for the size and weight of the child. For additional information, see the "Children in the vehicle" section.

A child's risk of serious or fatal injuries is significantly increased if the child restraints are not properly secured in the vehicle and/or the child is not properly secured in the child restraint.

! To avoid damage to the seats and the seat heating, observe the following information:

- keep liquids from spilling on the seats. If liquid is spilled on the seats, dry them as soon as possible.
- if the seat covers are damp or wet, do not switch on the seat heating. The seat heating should also not be used to dry the seats.
- clean the seat covers as recommended; see the "Interior care" section.
- do not transport heavy loads on the seats. Do not place sharp objects on the seat cushions, e.g. knives, nails or tools. The seats should only be occupied by passengers, if possible.
- when the seat heating is in operation, do not cover the seats with insulating materials, e.g. blankets, coats, bags, seat covers, child seats or booster seats.

! Make sure that there are no objects in the footwell or behind the seats when resetting the seats. There is a risk that the seats and/or the objects could be damaged.

i The head restraints in the front and rear seats can be removed.¹

For more information, contact a qualified specialist workshop.

i Further related subjects:

- Luggage compartment enlargement (folding down the rear seats)
(▷ page 254)

Adjusting the seats manually

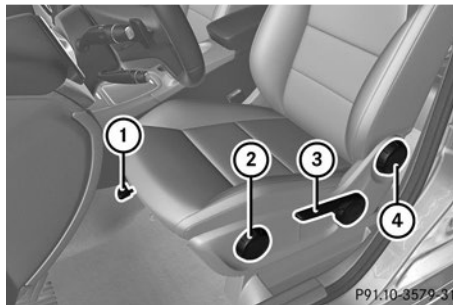

Seat fore-and-aft adjustment

- ▶ Lift handle ① and slide the seat forwards or backwards.
- ▶ Release lever ① again.
Make sure that you hear the seat engage in position.

Backrest angle

- ▶ Relieve the pressure on the backrest.
- ▶ Turn handwheel ④ forwards or backwards.

Seat height

- ▶ Pull handle ③ upwards or push it down repeatedly until the seat has reached the desired height.

Seat cushion angle

Adjust the angle so that your thighs are lightly supported.

- ▶ Turn handwheel ② forwards or backwards.

¹ Not on vehicles with sports seats.

Adjusting the seats electrically

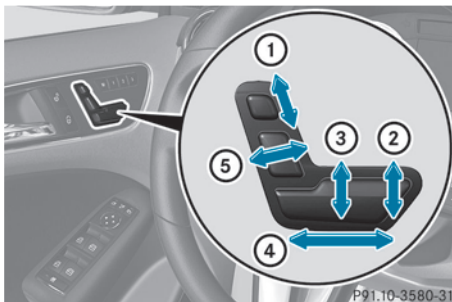

- ① Head restraint height²
- ② Seat cushion angle
- ③ Seat height
- ④ Seat fore-and-aft adjustment
- ⑤ Backrest angle

i You can store the seat settings using the memory function (▷ page 101).

Adjusting the head restraints

⚠ WARNING

You could lose control of your vehicle if you do the following while driving:

- adjust the driver's seat, head restraint, steering wheel or mirrors
- fasten the seat belt

There is a risk of an accident.

Adjust the driver's seat, head restraint, steering wheel and mirror and fasten your seat belt before starting the engine.

⚠ WARNING

If head restraints are not installed and adjusted correctly, they cannot provide protection as intended. There is an increased risk of injury in the head and neck area, e.g. in the event of an accident or when braking.

Always drive with the head restraints installed. Before driving off, make sure for every vehicle occupant that the center of the

head restraint supports the back of the head at about eye level.

Adjusting the head restraints manually

Adjusting the head restraint height

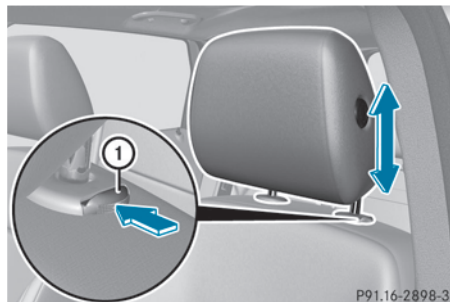

- ▶ **To raise:** pull the head restraint up to the desired position.
- ▶ **To lower:** press release catch ① in the direction of the arrow and push the head restraint down to the desired position.

Adjusting the fore/aft position of the head restraint

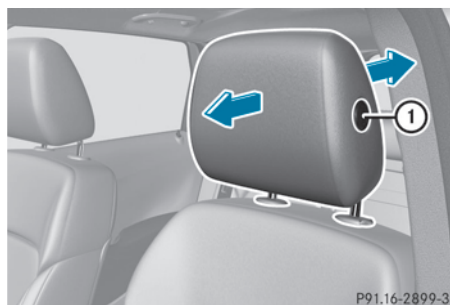

² Not available on vehicles with sports seats.

With this function you can adjust the distance between the head restraint and the back of the seat occupant's head.

- ▶ **To adjust forwards:** pull the head restraint forwards in the direction of the arrow until it engages.
There are several notches.
- ▶ **To move backwards:** press and hold release button ① and push the head restraint backwards.
- ▶ When the head restraint is in the desired position, release the button and make sure that the head restraint is engaged in position.

Adjusting the height of the head restraints electrically

- ▶ **To adjust the head restraint height:** slide the switch for head restraint adjustment (▷ page 95) up or down in the direction of the arrow.

Rear seat head restraints

Adjusting the rear seat head restraint height

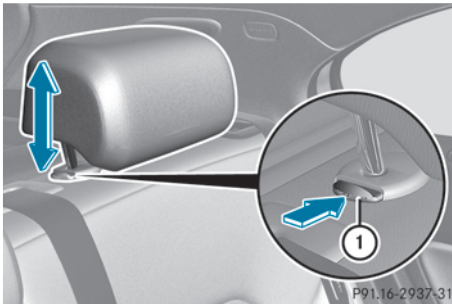

- ▶ **To raise:** pull the head restraint up to the desired position.
- ▶ **To lower:** press release catch ① and push the head restraint down until it is in the desired position.

Removing and installing the rear seat head restraints

⚠ WARNING

If head restraints are not installed and adjusted correctly, they cannot provide protection as intended. There is an increased risk of injury in the head and neck area, e.g. in the event of an accident or when braking. Always drive with the head restraints installed. Before driving off, make sure for every vehicle occupant that the center of the head restraint supports the back of the head at about eye level.

The rear head restraints on the outer seats can be removed and re-installed.

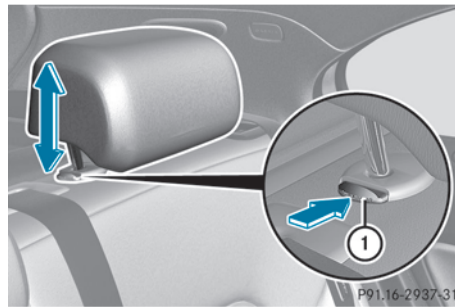

- ▶ Fold the seat backrest slightly forwards in order to remove the head restraint (▷ page 254).
- ▶ **To remove:** pull the head restraint up to the stop.
- ▶ Press release catch ① and pull the head restraint out of the guides.
- ▶ **To re-install:** insert the head restraint so that the notches on the bar are on the left when viewed in the direction of travel.
- ▶ Push the head restraint down until you hear it engage in position.

Adjusting the 4-way lumbar support

You can adjust the contour of the front seat backrests individually to provide optimum support for your back.

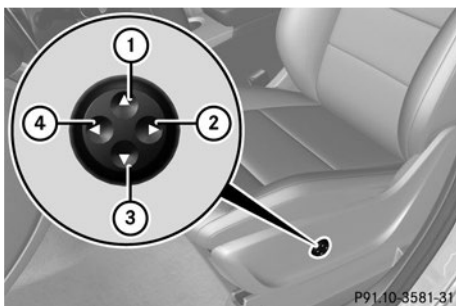

- ① To raise the backrest contour
- ② To soften the backrest contour
- ③ To lower the backrest contour
- ④ To harden the backrest contour

Switching the seat heating on/off

Activating/deactivating

WARNING

Repeatedly switching on the seat heating can cause the seat cushion and backrest pads to become very hot. The health of persons with limited temperature sensitivity or a limited ability to react to excessively high temperatures may be affected or they may even suffer burn-like injuries. There is a risk of injury.

Therefore, do not switch the seat heating on repeatedly.



The three red indicator lamps in the button indicate the heating level you have selected.

The system automatically switches down from level **3** to level **2** after approximately eight minutes.

The system automatically switches down from level **2** to level **1** after approximately ten minutes.

The system automatically switches off approximately 20 minutes after it is set to level **1**.

- ▶ Turn the SmartKey to position **1** or **2** in the ignition lock (▶ page 137).
- ▶ **To switch on:** press button ① repeatedly until the desired heating level is set.
- ▶ **To switch off:** press button ① repeatedly until all the indicator lamps go out.

- ❗ If the battery voltage is too low, the seat heating may switch off.

Problems with the seat heating

Problem	Possible causes/consequences and ► Solutions
The seat heating has switched off prematurely or cannot be switched on.	<p>The on-board voltage is too low because too many electrical consumers are switched on.</p> <p>► Switch off electrical consumers that you do not need, such as the rear window defroster or interior lighting.</p> <p>Once the battery is sufficiently charged, the seat heating will switch back on automatically.</p>

Steering wheel

Important safety notes

⚠ WARNING

You could lose control of your vehicle if you do the following while driving:

- adjust the driver's seat, head restraint, steering wheel or mirrors
- fasten the seat belt

There is a risk of an accident.

Adjust the driver's seat, head restraint, steering wheel and mirror and fasten your seat belt before starting the engine.

⚠ WARNING

Children could injure themselves if they adjust the steering wheel. There is a risk of injury.

When leaving the vehicle, always take the SmartKey with you and lock the vehicle. Never leave children unsupervised in the vehicle.

Adjusting the steering wheel

⚠ WARNING

If the steering wheel is unlocked while the vehicle is in motion, it could change position unexpectedly. This could cause you to lose control of the vehicle. There is a risk of an accident.

Before starting off, make sure the steering wheel is locked. Never unlock the steering wheel while the vehicle is in motion.

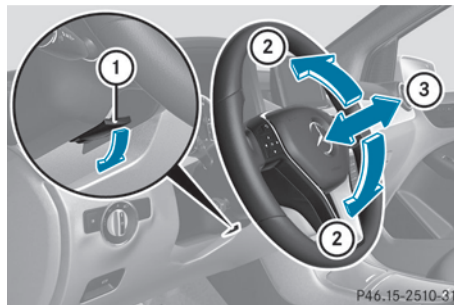

- ① Release lever
 - ② To adjust the steering wheel height
 - ③ To adjust the steering wheel position (fore-and-aft adjustment)
- Push release lever ① down completely. The steering column is unlocked.
 - Adjust the steering wheel to the desired position.
 - Push release lever ① up completely. The steering column is locked.
 - Check if the steering column is locked. When doing so, try to push the steering wheel up or down or try to move it in the fore-and-aft direction.

Mirrors

Rear-view mirror

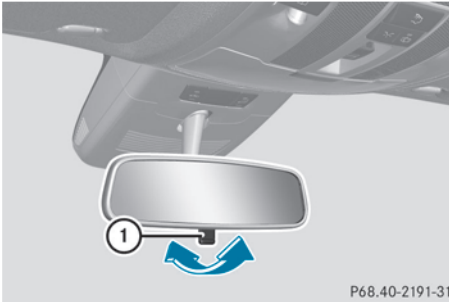

- ▶ **Anti-glare mode:** flick anti-glare lever (1) forwards or back.

Exterior mirrors

Adjusting the exterior mirrors

WARNING

The exterior mirror on the front-passenger side reduces the size of the image. Visible objects are actually closer than they appear. This means that you could misjudge the distance from road users traveling behind, e.g. when changing lane. There is a risk of an accident.

For this reason, always make sure of the actual distance from the road users traveling behind by glancing over your shoulder.

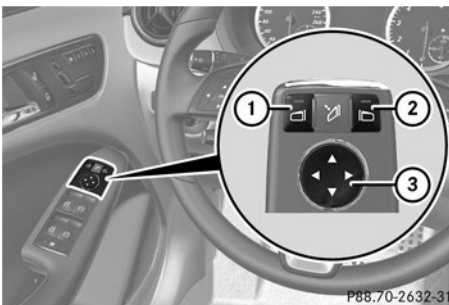

- ▶ Turn the SmartKey to position **1** or **2** in the ignition lock (▷ page 137).
- ▶ Press button (1) for the left-hand exterior mirror or button (2) for the right-hand exterior mirror.
The indicator lamp in the corresponding button lights up in red.
The indicator lamp goes out again after some time. You can adjust the selected mirror using adjustment button (3) as long as the indicator lamp is lit.
- ▶ Press adjustment button (3) up, down, or to the left or right until you have adjusted the exterior mirror to the correct position. You should have a good overview of traffic conditions.

The convex exterior mirrors provide a larger field of vision.

The exterior mirrors are automatically heated after starting the vehicle if the rear window defroster is switched on and the outside temperature is low. Heating takes a maximum of 10 minutes.

- i** You can also heat up the exterior mirrors manually by switching on the rear window defroster.

Folding the exterior mirrors in or out electrically



- ▶ Turn the SmartKey to position **1** or **2** in the ignition lock (▷ page 137).
- ▶ Briefly press button (1).
Both exterior mirrors fold in or out.

- i** Make sure that the exterior mirrors are always folded out fully while driving. They could otherwise vibrate.
- i** If you are driving faster than 30 mph (47 km/h), you can no longer fold in the exterior mirrors.

Setting the exterior mirrors

If the battery has been disconnected or completely discharged, the exterior mirrors must be reset. The exterior mirrors will otherwise not fold in when you select the "Fold in mirrors when locking" function in the on-board computer (▷ page 206).

- ▶ Turn the SmartKey to position **1** in the ignition lock (▷ page 137).
- ▶ Briefly press button **①**.

Folding the exterior mirrors in or out automatically

If the "Fold in mirrors when locking" function is activated in the on-board computer (▷ page 206):

- the exterior mirrors fold in automatically as soon as you lock the vehicle from the outside.
- the exterior mirrors fold out again automatically as soon as you unlock the vehicle and then open the driver's or front-passenger door.

- i** If the exterior mirrors have been folded in manually, they do not fold out.

Exterior mirror pushed out of position

If an exterior mirror has been pushed out of position, proceed as follows:

- ▶ **Vehicles without electrically folding exterior mirrors:** move the exterior mirror into the correct position manually.
- ▶ **Vehicles with electrically folding exterior mirrors:** press and hold mirror-folding button (▷ page 99) until you hear a

click and then the mirrors engage in position.

The mirror housing is engaged again and you can adjust the exterior mirrors as usual (▷ page 99).

Automatic anti-glare mirrors

The "Automatic anti-glare mirrors" function is only available if the vehicle is equipped with the "Mirrors package".

The rear-view mirror and the exterior mirror on the driver's side automatically go into anti-glare mode if:

- the ignition is switched on and
- incident light from headlamps strikes the sensor in the rear-view mirror.

The mirrors do not go into anti-glare mode if reverse gear is engaged or the interior lighting is switched on.

Parking position for the exterior mirror on the front-passenger side

General notes

The "Parking position of the exterior mirror on the front-passenger side" function is only available if the vehicle is equipped with the "Mirrors package".

Setting and storing the parking position

Using reverse gear

You can position the front-passenger side exterior mirror in such a way that you can see the rear wheel on that side as soon as you engage reverse gear. You can store this position.

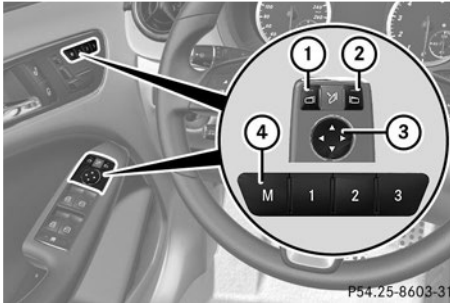

- ▶ Make sure that the vehicle is stationary.
 - ▶ Turn the SmartKey to position **2** in the ignition lock (▷ page 137).
 - ▶ Press button **②** for the exterior mirror on the front-passenger side.
 - ▶ Engage reverse gear.
The exterior mirror on the front-passenger side moves to the preset parking position.
 - ▶ Use adjustment button **③** to adjust the exterior mirror. You should see the rear wheel and the curb in the exterior mirror. The parking position is stored.
- i** If you shift the transmission to another position, the exterior mirror on the front-passenger side returns to the driving position.

Using the memory button

You can position the front-passenger side exterior mirror in such a way that you can see the rear wheel on that side as soon as you engage reverse gear. You can store this position. This setting can be stored using memory button **M** **④**.

- ▶ Make sure that the vehicle is stationary.
- ▶ Turn the SmartKey to position **2** in the ignition lock (▷ page 137).
- ▶ Press button **②** for the exterior mirror on the front-passenger side.
- ▶ Use adjustment button **③** to adjust the exterior mirror. You should see the rear wheel and the curb in the exterior mirror.

- ▶ Press memory button **M** **④** and one of the arrows on adjustment button **③** within three seconds.
The parking position is stored if the exterior mirror does not move.
- ▶ If the mirror moves out of position, repeat the steps.

Calling up a stored parking position setting

- ▶ Turn the SmartKey to position **2** in the ignition lock (▷ page 137).
- ▶ Adjust the exterior mirror on the front-passenger side with the corresponding button (▷ page 99).
- ▶ Engage reverse gear.
The exterior mirror on the front-passenger side moves to the stored parking position.

The exterior mirror on the front-passenger side moves back to its original position:

- as soon as you exceed a speed of 9 mph (15 km/h)
- about ten seconds after you have disengaged reverse gear
- if you press button **①** for the exterior mirror on the driver's side

Memory functions

Storing settings

⚠ WARNING

If you use the memory function on the driver's side while driving, you could lose control of the vehicle as a result of the adjustments being made. There is a risk of an accident.

Only use the memory function on the driver's side when the vehicle is stationary.

⚠ WARNING

When the memory function adjusts the seat, you and other vehicle occupants – particularly children – could become trapped. There is a risk of injury.

While the memory function is making adjustments, make sure that no one has any body parts in the sweep of the seat. If somebody becomes trapped, immediately release the memory function position button. The adjustment process is stopped.

WARNING

Children could become trapped if they activate the memory function, particularly when unattended. There is a risk of injury. When leaving the vehicle, always take the SmartKey with you and lock the vehicle. Never leave children unsupervised in the vehicle.

With the memory function, you can store up to three different settings, e.g. for three different people.

The following settings are stored as a single memory preset:

- position of the seat, backrest and head restraint
- driver's side: position of the exterior mirrors on the driver's and front-passenger sides

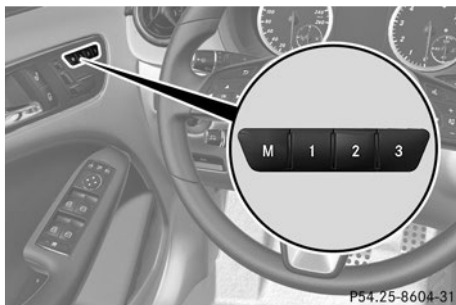

- ▶ Adjust the seat (▷ page 95).
- ▶ Adjust the exterior mirror on the driver's side (▷ page 99).
- ▶ Briefly press the **M** memory button and then press storage position button **1**, **2** or **3** within three seconds.

The settings are stored in the selected preset position. A tone sounds when the settings have been completed.

Calling up a stored setting

- ▶ Press and hold the relevant storage position button **1**, **2** or **3** until the seat and exterior mirrors are in the stored position.
- i** The setting procedure is interrupted as soon as you release the storage position button.

Useful information	104
Exterior lighting	104
Interior lighting	109
Replacing bulbs	110
Windshield wipers	117

Useful information

- i** This Operator's Manual describes all models and all standard and optional equipment of your vehicle available at the time of publication of the Operator's Manual. Country-specific differences are possible. Please note that your vehicle may not be equipped with all features described. This also applies to safety-related systems and functions.
- i** Read the information on qualified specialist workshops: (▷ page 25).

Exterior lighting

General notes

For reasons of safety, Mercedes-Benz recommends that you drive with the lights switched on even during the daytime. In some countries, operation of the headlamps varies due to legal requirements and self-imposed obligations.

Driving abroad

Conversion to symmetrical low beam

Switch the headlamps to symmetrical low beam in countries in which traffic drives on the opposite side of the road from the country where the vehicle is registered. This prevents glare to oncoming traffic. When using symmetrical lights, the edge of the road is not lit as widely and as far ahead as normal.

Have the headlamps converted at a qualified specialist workshop as close to the border as possible before driving in these countries.

Conversion to asymmetrical low beam after returning

Have the headlamps converted back to asymmetrical low-beam headlamps at a qualified specialist workshop as soon as possible after crossing the border again.

Setting the exterior lighting

Setting options

Exterior lighting can be set using:

- the light switch
- the combination switch (▷ page 106)
- the on-board computer (▷ page 203)

Light switch

Operation

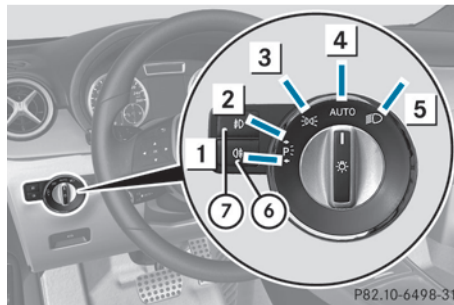

- 1** Left-hand standing lamps
- 2** Right-hand standing lamps
- 3** Parking lamps, license plate and instrument cluster lighting
- 4** **AUTO** Automatic headlamp mode, controlled by the light sensor
- 5** Low-beam/high-beam headlamps
- 6** Rear fog lamp
- 7** Fog lamp (only vehicles with front fog lamps)

If you hear a warning tone when you leave the vehicle, the lights may still be switched on.

- Turn the light switch to **AUTO**.

The exterior lighting (except the parking/standing lamps) switches off automatically if you:

- remove the SmartKey from the ignition lock
- open the driver's door with the SmartKey in position **0**.

Automatic headlamp mode

WARNING

When the light switch is set to **AUTO**, the low-beam headlamps may not be switched on automatically if there is fog, snow or other causes of poor visibility due to the weather conditions such as spray. There is a risk of an accident.

In such situations, turn the light switch to .

The automatic headlamp feature is only an aid. The driver is responsible for the vehicle's lighting at all times.

AUTO is the favored light switch setting. The light setting is automatically selected according to the brightness of the ambient light (exception: poor visibility due to weather conditions such as fog, snow or spray):

- SmartKey in position **1** in the ignition lock: the parking lamps are switched on or off automatically depending on the brightness of the ambient light.
- With the engine running: if you have activated the daytime running lamps function via the on-board computer, the daytime running lamps or the low-beam headlamps and parking lamps are switched on or off automatically depending on the brightness of the ambient light.

► **To switch on automatic headlamp mode:** turn the light switch to **AUTO**.

The daytime running lamps improve the visibility of your vehicle during the day. The daytime running lamps function is required by law in Canada.

When the engine is running and the vehicle is stationary: if you move the selector lever from a drive position to **P**, the daytime running lamps/low-beam headlamps go out after three minutes.



When the engine is running, the vehicle is stationary and in bright ambient light: if you turn the light switch to , the daytime running lamps and parking lamps switch on.

If the engine is running and you turn the light switch to , the manual settings take precedence over the daytime running lamps.

Low-beam headlamps

Even if the light sensor does not detect that it is dark, the parking lamps and low-beam headlamps switch on when the ignition is switched on and the light switch is set to the  position. This is a particularly useful function in the event of rain and fog.

► **To switch on the low-beam headlamps:** turn the SmartKey in the ignition lock to position **2** or start the engine.



► Turn the light switch to .
The green  indicator lamp in the instrument cluster lights up.

Front fog lamps

In conditions where visibility is poor due to fog, snow or rain, the fog lamps improve visibility as well as making it easier for other road users to see you. They can be operated together with the parking lamps or together with the parking lamps and low-beam headlamps.

► **To switch on the front fog lamps:** turn the SmartKey in the ignition lock to position **2** or start the engine.

► Turn the light switch to  or **AUTO**.

► Press the  button.
The green  indicator lamp in the instrument cluster lights up.





► **To switch off the front fog lamps:** press the  button.

The green  indicator lamp in the instrument cluster goes out.



Only vehicles with front fog lamps are equipped with the "fog lamp" function; information on the fog lamp function for vehicles with Intelligent Light System (> page 108).



Rear fog lamp

The rear fog lamp improves visibility of your vehicle for the traffic behind in the event of thick fog. Please take note of the country-specific regulations for the use of rear fog lamps.

- ▶ **To switch on the rear fog lamps:** turn the SmartKey in the ignition lock to position **2** or start the engine.
- ▶ Turn the light switch to  or **AUTO**.
- ▶ Press the  button.
The yellow  indicator lamp in the instrument cluster lights up.
- ▶ **To switch off the rear fog lamp:** press the  button.
The yellow  indicator lamp in the instrument cluster goes out.



Parking lamps

! If the battery has been excessively discharged, the parking lamps or standing lamps are automatically switched off to enable the next engine start. Always park your vehicle safely and sufficiently lit according to legal standards. Avoid the continuous use of the  parking lamps for several hours. If possible, switch on the  right or the  left standing lamp.

- ▶ **To switch on:** turn the light switch to .
The green  indicator lamp in the instrument cluster lights up.

Standing lamps

Switching on the standing lamps ensures the corresponding side of the vehicle is illuminated.

- ▶ **To switch on the standing lamps:** the SmartKey is not in the ignition lock or it is in position **0**.
- ▶ Turn the light switch to  (left-hand side of the vehicle) or  (right-hand side of the vehicle).

Combination switch

Turn signal

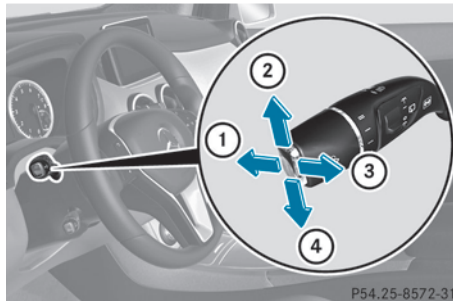



- ① High-beam headlamps
- ② Turn signal, right
- ③ High-beam flasher
- ④ Turn signal, left

- ▶ **To indicate briefly:** press the combination switch briefly to the pressure point in the direction of arrow ② or ④.
The corresponding turn signal flashes three times.
- ▶ **To indicate:** press the combination switch beyond the pressure point in the direction of arrow ② or ④.

High-beam headlamps

- ▶ **To switch on the high-beam headlamps:** turn the SmartKey in the ignition lock to position **2** or start the engine.
- ▶ Turn the light switch to  or **AUTO**.
- ▶ Press the combination switch beyond the pressure point in the direction of arrow ①.
In the **AUTO** position, the high-beam headlamps are only switched on when it is dark and the engine is running.

The blue  indicator lamp in the instrument cluster lights up when the high-beam headlamps are switched on.

- ▶ **To switch off the high-beam headlamps:** move the combination switch back to its normal position. The blue  indicator lamp in the instrument cluster goes out.

i Vehicles with Adaptive Highbeam Assist: when Adaptive Highbeam Assist is active, it controls activation of the high-beam headlamps (▶ page 108).

High-beam flasher

- ▶ **To switch on:** turn the SmartKey in the ignition lock to position **1** or **2** or start the engine.
- ▶ Pull the combination switch in the direction of arrow **③**.

Hazard warning lamps



The hazard warning lamps automatically switch on if:

- an air bag is deployed
 - the vehicle decelerates rapidly from a speed of more than 45mph (70 km/h) and comes to a standstill
- ▶ **To switch on the hazard warning lamps:** press button **①**. All turn signals flash. If you now switch on a turn signal using the combination switch,

only the turn signal lamp on the corresponding side of the vehicle will flash.

- ▶ **To switch off the hazard warning lamps:** press button **①**.

The hazard warning lamps switch off automatically if the vehicle reaches a speed of over 6mph (10km/h) again after a full brake application.

i The hazard warning lamps still operate if the ignition is switched off.

Cornering light function



The cornering light function improves the illumination of the road over a wide angle in the direction you are turning, enabling better visibility in tight bends, for example. The cornering light function can only be activated when the low-beam headlamps are switched on.

Active:

- if you are driving at speeds below 25 mph (40 km/h) and switch on the turn signal or turn the steering wheel.
- if you are driving at speeds between 25 mph (40 km/h) and 45 mph (70 km/h) and turn the steering wheel.

Not active: if you are driving at speeds above 25 mph (40 km/h) or switch off the turn signal or turn the steering wheel to the straight-ahead position.

The cornering lamp may remain lit for a short time, but is automatically switched off after no more than three minutes.

Extended range fog lamps

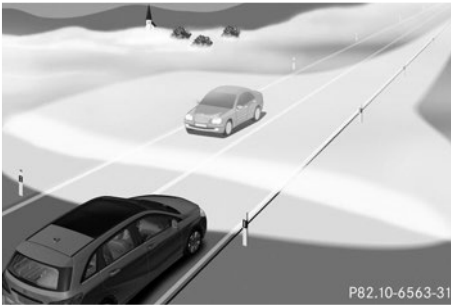

The extended range fog lamps reduce the glare experienced by the driver and improve the illumination of the edge of the road.

Active: if you are driving at speeds below 40 mph (70 km/h) and you switch on the rear fog lamp.

Not active: if, following activation, you are driving at speeds above 60 mph (100 km/h) or if you switch off the rear fog lamp.

Adaptive Highbeam Assist

Important safety notes

WARNING

Adaptive Highbeam Assist does not recognize road users:

- who have no lights, e.g. pedestrians
- who have poor lighting, e.g. cyclists
- whose lighting is blocked, e.g. by a barrier

In very rare cases, Adaptive Highbeam Assist may fail to recognize other road users that have lights, or may recognize them too late. In this or similar situations, the automatic high-beam headlamps will not be deactivated or activated regardless. There is a risk of an accident.

Always carefully observe the traffic conditions and switch off the high-beam headlamps in good time.

Adaptive Highbeam Assist cannot take into account road, weather or traffic conditions.

Adaptive Highbeam Assist is only an aid. You are responsible for adjusting the vehicle's lighting to the prevailing light, visibility and traffic conditions.

In particular, the detection of obstacles can be restricted if there is:

- poor visibility, e.g. due to fog, heavy rain or snow
- dirt on the sensors or the sensors are obscured

General notes

You can use this function to set the headlamps to change between low beam and high beam automatically. The system recognizes vehicles with their lights on, either approaching from the opposite direction or traveling in front of your vehicle, and consequently switches the headlamps from high beam to low beam.

The system automatically adapts the low-beam headlamp range depending on the distance to the other vehicle. Once the system no longer detects any other vehicles, it reactivates the high-beam headlamps.

The system's optical sensor is located behind the windshield near the overhead control panel.



Switching Adaptive Highbeam Assist on/off

- ▶ **To activate:** activate the Adaptive Highbeam Assist function using the on-board computer (▷ page 203).
- ▶ Turn the light switch to **AUTO**.
- ▶ Press the combination switch beyond the pressure point in the direction of arrow ① (▷ page 106).

The  indicator lamp in the multifunction display lights up if it is dark and the light sensor activates the low-beam headlamps.

If you are driving at speeds above approximately 28 mph (45 km/h):



The headlamp range is set automatically depending on the distance between the vehicle and other road users.

If you are driving at speeds above approximately 35 mph (55 km/h) and no other road users have been detected:

The high-beam headlamps are switched on automatically. The  indicator lamp in the instrument cluster also lights up.

If you are driving at speeds below approximately 30 mph (45 km/h) or other

road users have been detected or the roads are adequately lit:

The high-beam headlamps are switched off automatically. The  indicator lamp in the instrument cluster goes out. The  indicator lamp in the multifunction display remains lit.

- ▶ **To deactivate:** move the combination switch back to its normal position. The  indicator lamp in the multifunction display goes out.

Headlamps fogged up on the inside

The headlamps may fog up on the inside if there is high atmospheric humidity.

- ▶ Switch on the lights and drive off. The level of moisture diminishes, depending on the length of the journey and the weather conditions (humidity and temperature).

If the level of moisture does not diminish:



- ▶ Have the headlamps checked at a qualified specialist workshop.

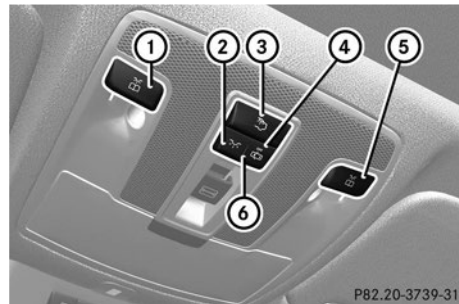

Interior lighting

Overview of interior lighting



Front overhead control panel

- ①  To switch the left-hand front reading lamp on/off
- ②  To switch the front interior lighting on

- ③  To switch the on/off
- ④  To switch the front interior lighting/automatic interior lighting control off
- ⑤  To switch the right-hand front reading lamp on/off
- ⑥ To switch the automatic interior lighting control on

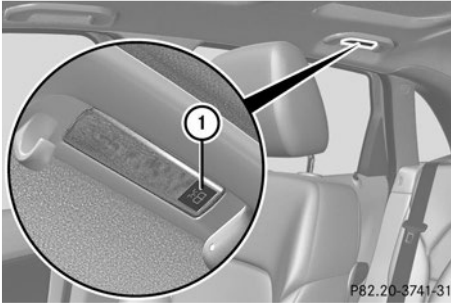

Rear-compartment overhead control panel

- ① To switch the reading lamp on/off

Interior lighting control

Important notes

In order to prevent the vehicle's battery from discharging, the interior lighting functions are automatically deactivated after some time unless the SmartKey is in position **2** in the ignition lock.

The brightness of the ambient lighting may be set using the on-board computer (> page 204).

Automatic interior lighting control





- ▶ **To switch on:** set the switch to center position ⑥.
- ▶ **To switch off:** set the switch to the  position.

The interior lighting automatically switches on if you:

- unlock the vehicle
- open a door
- remove the SmartKey from the ignition lock.

The interior light is activated for a short while when the SmartKey is removed from the ignition lock. You can activate this delayed switch-off using the on-board computer (> page 204).

Manual interior lighting control

- ▶ **To switch the front interior lighting on:** set the switch to the  position.
- ▶ **To switch the interior lighting off:** set the switch to the  position or (if the door is closed) to the center position.
- ▶ **To switch the interior lighting on/off:** press the  button.
- ▶ **To switch the reading lamps on/off:** press the  button.

Crash-responsive emergency lighting

The interior lighting is activated automatically if the vehicle is involved in an accident.

- ▶ **To switch off the crash-responsive emergency lighting:** press the hazard warning lamp button.
- or
- ▶ Lock and then unlock the vehicle using the key.

Replacing bulbs

Important safety notes

Xenon bulbs

DANGER

Xenon bulbs carry a high voltage. You can get an electric shock if you remove the cover of

the Xenon bulb and touch the electrical contacts. There is a risk of fatal injury.

Never touch the parts or the electrical contacts of the Xenon bulb. Always have work on the Xenon bulbs carried out at a qualified specialist workshop.

If your vehicle is equipped with Xenon bulbs, you can recognize this by the following: the cone of light from the Xenon bulbs moves from the top to the bottom and back again when you start the engine. For this to be observed, the lights must be switched on before starting the engine.

Bulbs and lamps are an important aspect of vehicle safety. You must therefore make sure that these function correctly at all times. Have the headlamp setting checked regularly.

Other bulbs

WARNING

Bulbs, lamps and connectors can get very hot when operating. If you change a bulb, you could burn yourself on these components. There is a risk of injury.

Allow these components to cool down before changing a bulb.

Do not use a bulb that has been dropped or if its glass tube has been scratched.

The bulb may explode if:

- you touch it
- it is hot
- you drop it
- you scratch it

Only operate bulbs in enclosed lamps designed for that purpose. Only install spare bulbs of the same type and the specified voltage.

Marks on the glass tube reduce the service life of the bulbs. Do not touch the glass tube with your bare hands. If necessary, clean the glass tube when cold with alcohol or spirit and rub it off with a lint-free cloth.

Protect bulbs from moisture during operation. Do not allow bulbs to come into contact with liquids.

There are bulbs other than the Xenon bulbs that you cannot replace. Replace only the bulbs listed (▷ page 111). Have the bulbs that you cannot replace yourself changed at a qualified specialist workshop.

If you require assistance changing bulbs, consult a qualified specialist workshop.

If the new bulb still does not light up, consult a qualified specialist workshop.

Bulbs and lamps are an important aspect of vehicle safety. You must therefore make sure that these function correctly at all times. Have the headlamp setting checked regularly.

Overview: changing bulbs/bulb types

You can change the following bulbs. The bulb type can be found in the legend.

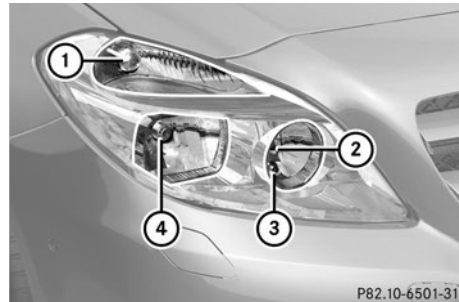

Vehicles with halogen headlamps

- ① Turn signal lamp: 3457
- ② High-beam headlamp: H7 55 W
- ③ Parking lamp/standing lamp: W 5 W LL
- ④ Low-beam headlamp: H7 55 W

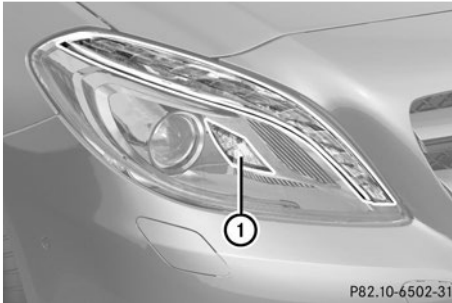

Vehicles with Bi-Xenon headlamps

- ① Cornering lamp: H7 55 W

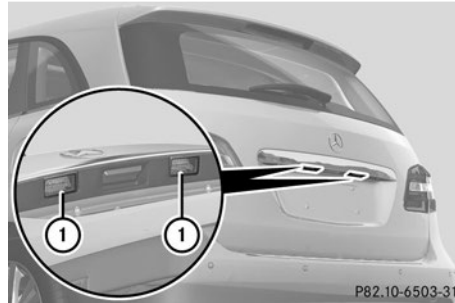

License plate lamp (vehicles with halogen headlamps)

- ① License plate lamp: C 5 W

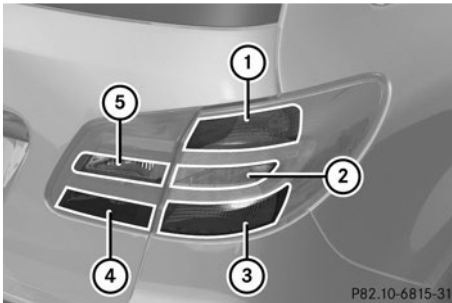

Tail lamps (vehicles with halogen headlamps)

- ① Tail lamp/turn signal lamp/brake lamp: P 21 W
 ② Inoperative
 ③ Side marker lamp: P 21 W
 ④ Rear fog lamp: P 21 W
 ⑤ Backup lamp: W 16 W

Changing the front bulbs

Removing and installing the cover in the front wheel housing

You must remove the cover from the front wheel housing before you can change the front bulbs.

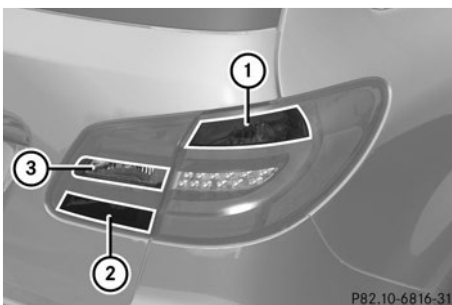
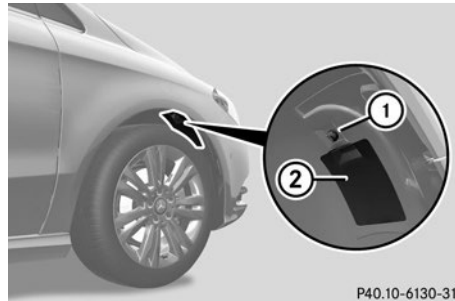

Tail lamps (vehicles with Bi-Xenon headlamps)

- ① Turn signal lamp/brake lamp: P 21 W
 ② Rear fog lamp: H 21 W
 ③ Backup lamp: W 16 W

- ▶ **To remove:** switch off the lights.
- ▶ Turn the front wheels inwards.
- ▶ Turn rotary knob ① through 90°. Cover ② is released.
- ▶ Push cover ② down.
- ▶ **To install:** push cover ② up.
- ▶ Turn rotary knob ① through 90°. Cover ② is locked.

Low-beam headlamps (halogen headlamps)

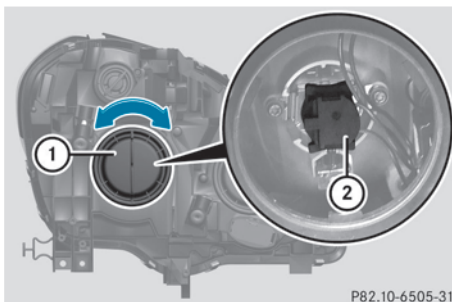

- ▶ Remove the cover in the front wheel housing (▷ page 112).
- ▶ Turn housing cover ① counter-clockwise and pull it out.
- ▶ Turn bulb holder ② counter-clockwise and pull it out.
- ▶ Take the bulb out of bulb holder ②.
- ▶ Insert the new bulb into bulb holder ②.
- ▶ Insert bulb holder ② into the lamp and turn it clockwise.
- ▶ Align housing cover ① and turn it clockwise until it engages.
- ▶ Replace the cover in the front wheel housing (▷ page 112).

High-beam headlamps (halogen headlamps)

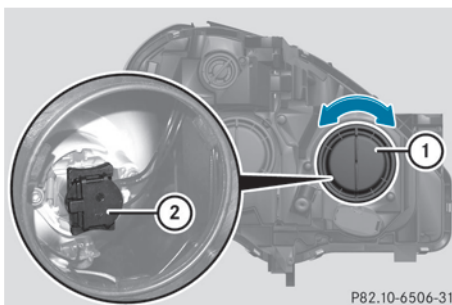

- ▶ Switch off the lights.
- ▶ Open the hood.

- ▶ Turn housing cover ① counter-clockwise and pull it out.
- ▶ Turn bulb holder ② counter-clockwise and pull it out.
- ▶ Take the bulb out of bulb holder ②.
- ▶ Insert the new bulb into bulb holder ②.
- ▶ Insert bulb holder ② into the lamp and turn it clockwise.
- ▶ Align housing cover ① and turn it clockwise until it engages.

Parking lamps/standing lamps (halogen headlamps)

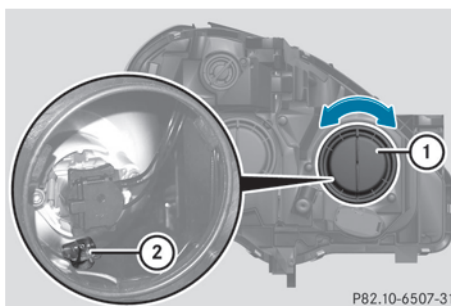

- ▶ Switch off the lights.
- ▶ Open the hood.
- ▶ Turn housing cover ① counter-clockwise and pull it out.
- ▶ Pull out bulb holder ②.
- ▶ Take the bulb out of bulb holder ②.
- ▶ Insert the new bulb into bulb holder ②.
- ▶ Insert bulb holder ②.
- ▶ Align housing cover ① and turn it clockwise until it engages.

Turn signals (halogen headlamps)

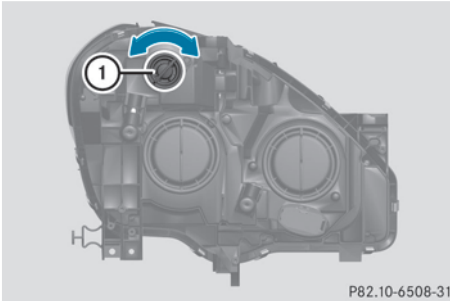

- ▶ Switch off the lights.
- ▶ Open the hood.
- ▶ Turn bulb holder ① counter-clockwise and pull it out.
- ▶ Take the bulb out of bulb holder ①.
- ▶ Insert the new bulb into bulb holder ①.
- ▶ Insert bulb holder ① and turn it clockwise until it engages.

Cornering light function (Bi-Xenon headlamps)

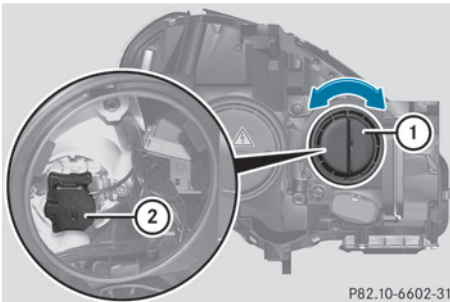

- ▶ Switch off the lights.
- ▶ Open the hood.
- ▶ Turn housing cover ① counter-clockwise and pull it out.
- ▶ Turn bulb holder ② counter-clockwise and pull it out.
- ▶ Take the bulb out of bulb holder ②.
- ▶ Insert the new bulb into bulb holder ②.

- ▶ Insert bulb holder ② into the lamp and turn it clockwise.
- ▶ Align housing cover ① and turn it clockwise until it engages.

Changing the rear bulbs

Opening and closing the side trim panels

You must open the side trim panel in the cargo compartment before you can change the bulbs in the tail lamps.

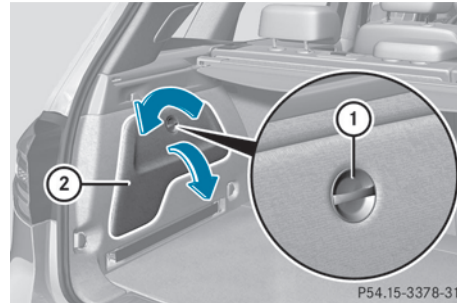

Left-hand side trim panel

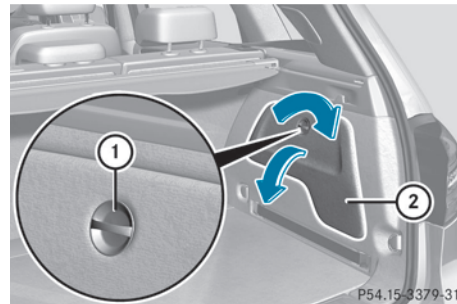

Right-hand side trim panel

- ▶ **To open:** turn release knob ① 90° in the direction of the arrow and remove side trim panel ②.
- ▶ **To close:** insert side trim panel ② and turn release knob ① 90° in the opposite direction to the arrow.

Tail lamp

Turn signal lamp/tail lamp and brake lamp

- ▶ Switch off the lights.
- ▶ Open the cargo compartment.
- ▶ Open the side trim panel (▷ page 114).

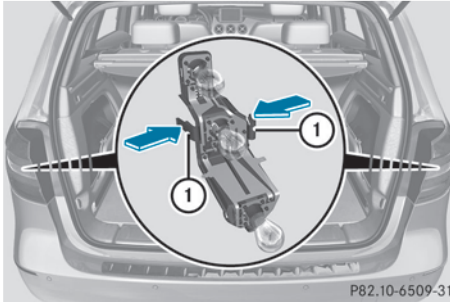

- ▶ Press retaining lugs ① simultaneously in the direction of the arrow and pull the bulb holder out.

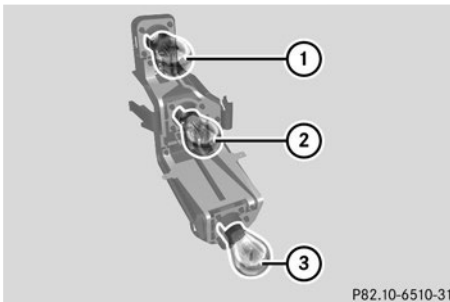

Bulb holder

- ① Tail lamp/brake lamp³
- ② Inoperative lamps (vehicles without LEDs)
- ③ Side marker lamp (vehicles without LEDs)

- ▶ Lightly press the corresponding bulb into the holder, turn it counter-clockwise and remove it from the bulb holder.
- ▶ Insert the corresponding new bulb into the bulb holder and turn it clockwise.

³ Vehicles with LEDs: turn signal/brake light only.

- ▶ Attach the bulb holder and press firmly. The retaining lugs on the bulb holder engage audibly.
- ▶ Close the side trim panel (▷ page 114).

Backup lamp and rear fog lamp

Due to their location, have the bulbs in the backup lamp and rear fog lamp in the tailgate changed at a qualified specialist workshop.

- ▶ Switch off the lights.
- ▶ Open the tailgate.

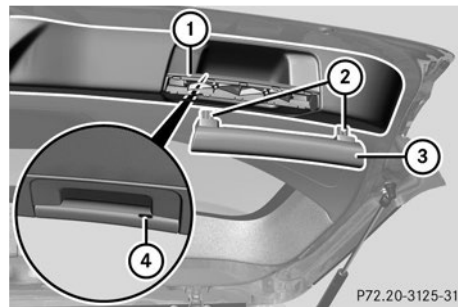

- ▶ In recess ④ on the inside of the closing handle, pry off and remove the upper section of handle ③ with a flat and smooth object, e.g. a screwdriver.
- ▶ Pull the lower section of handle ① using a sharp, sudden movement to remove it from the trim and then place it to one side.

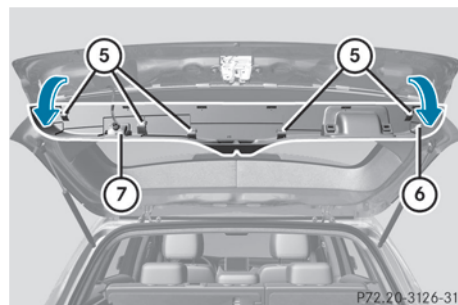

- ▶ Reach under the right-hand side of trim ⑥ and apply a gentle jolting force along the entire length of the trim in order to unclip it.

- ▶ Pull out connector ⑦ of the surround lighting by releasing the latches.
- ▶ Place trim ⑥ to one side.

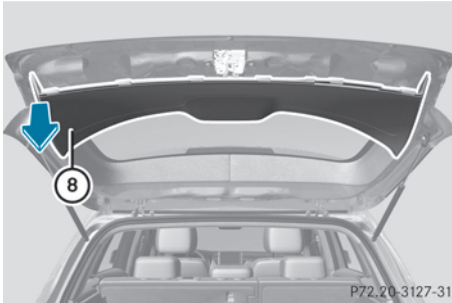

- ▶ On the side where the bulb is to be changed, unclip the remaining part of trim ⑧ from the assembly using a sudden, sharp movements, until bulb holder ⑨ is accessible.

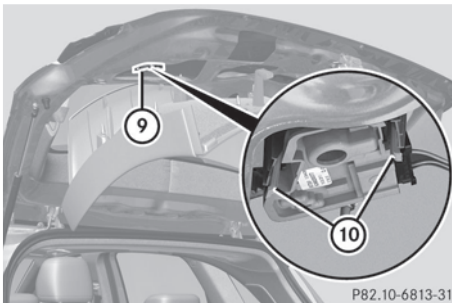

- ▶ Remove bulb holder ⑨ using both sides of lever ⑩.

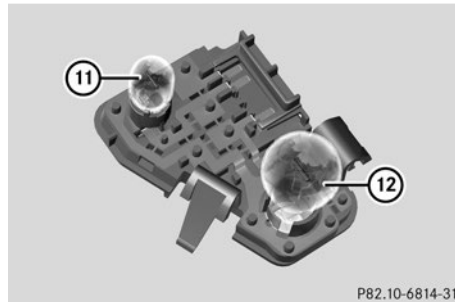

Bulb holder

- ▶ **Rear fog lamp** ⑪: lightly press the corresponding bulb into holder ⑨, turn it counter-clockwise and remove it from bulb holder ⑨.
- ▶ Insert the new bulb into bulb holder ⑨ and turn it clockwise.
- ▶ **Backup lamp** ⑫: remove the bulb from bulb holder ⑨.
- ▶ Insert the new bulb into bulb holder ⑨.
- ▶ Re-insert bulb holder ⑨ until you hear engage audibly.
- ▶ Position trim ⑧ and engage it in place by tapping it with your hand.
- ▶ Before beginning the installation, check that all the metal clips are inserted in the parts placed to one side: 2 clips ② in the upper part of handle ③ and 5 clips ⑤ in trim ⑥.
- ▶ If not, remove the missing metal clips from the metal openings in the tailgate and insert them in the appropriate places.
- ▶ Take trim ⑥ and connect plug connector ⑦ to the surround lighting.

i The surround lighting only illuminates when the tailgate has been shut and reopened.

- ▶ Position trim ⑥ and engage it in place by tapping it with your hand, starting from the outside.
- ▶ Clip in the lower section of handle ① again.
- ▶ Insert and engage the upper section of handle ③ into lower section ①.

License plate lamp

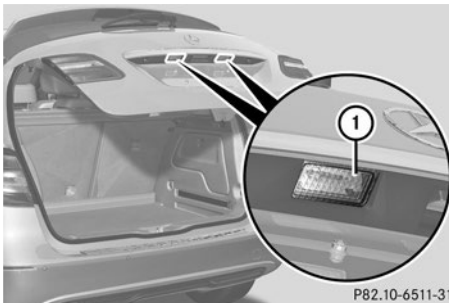

P82.10-6511-31

- ▶ Switch off the lights.
- ▶ Open the tailgate.
- ▶ Position a screwdriver on lamp lens ① from the outside.
- ▶ Lever out lamp lens ① and remove it.
- ▶ Replace the bulb.
- ▶ Insert lamp lens ① into the license plate lamp and press it in until it engages.

Windshield wipers

Switching the windshield wipers on/off

! Do not operate the windshield wipers when the windshield is dry, as this could damage the wiper blades. Moreover, dust that has collected on the windshield can scratch the glass if wiping takes place when the windshield is dry.

If it is necessary to switch on the windshield wipers in dry weather conditions, always use washer fluid when operating the windshield wipers.

! If the windshield wipers leave smears on the windshield after the vehicle has been washed in an automatic car wash, wax or other residues may be the reason for this. Clean the windshield using washer fluid after washing the vehicle in an automatic car wash.

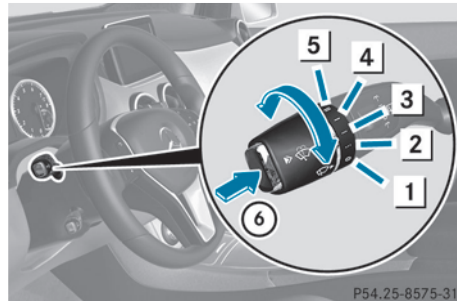

P54.25-8575-31

Combination switch

- ① 0 Windshield wiper off
- ② ... Intermittent wipe, low (rain sensor set to low sensitivity)
- ③ Intermittent wipe, high (rain sensor set to high sensitivity)
- ④ — Continuous wipe, slow
- ⑤ = Continuous wipe, fast
- ⑥ / To wipe the windshield using washer fluid

- ▶ Switch on the ignition.
- ▶ Turn the combination switch to the corresponding position.

! Vehicles with a rain sensor: if the windshield becomes dirty in dry weather conditions, the windshield wipers may be activated inadvertently. This could then damage the windshield wiper blades or scratch the windshield.

For this reason, you should always switch off the windshield wipers in dry weather.

Vehicles with a rain sensor: in the ... or position, the appropriate wiping frequency is automatically set according to the intensity of the rain. In the position, the rain sensor is more sensitive than in



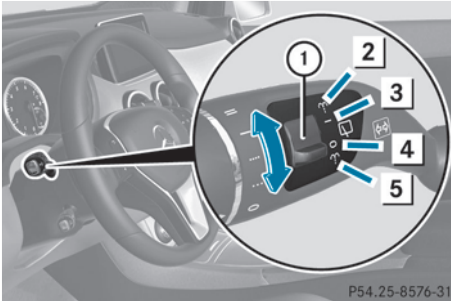

the  position, causing the windshield wipers to wipe more frequently.

If the wiper blades are worn, the windshield will no longer be wiped properly. This could prevent you from observing the traffic conditions. Replace the wiper blades twice a year, ideally in spring and fall.

Switching the rear window wiper on/off



Combination switch

- ①  Switch
- ②  To wipe with washer fluid
- ③  To switch on intermittent wiping
- ④  To switch off intermittent wiping
- ⑤  To wipe with washer fluid

- ▶ Turn the SmartKey to position **1** or **2** in the ignition lock.
- ▶ Turn switch ① on the combination switch to the corresponding position. When the rear window wiper is switched on, the icon appears in the instrument cluster.

Replacing the wiper blades

Important safety notes

WARNING

If the windshield wipers begin to move while you are changing the wiper blades, you could be trapped by the wiper arm. There is a risk of injury.

Always switch off the windshield wipers and ignition before changing the wiper blades.

- ❗ To avoid damaging the wiper blades, make sure that you touch only the wiper arm of the wiper.
- ❗ Never open the hood/tailgate if a wiper arm has been folded away from the windshield/rear window. Never fold a windshield wiper arm without a wiper blade back onto the windshield/rear window. Hold the windshield wiper arm firmly when you change the wiper blade. If you release the wiper arm without a wiper blade and it falls onto the windshield/rear window, the windshield/rear window may be damaged by the force of the impact. Mercedes-Benz recommends that you have the wiper blades changed at a qualified specialist workshop.

Changing the windshield wiper blades

Removing the wiper blades

- ▶ Remove the SmartKey from the ignition lock.
- ▶ Fold the wiper arm away from the windshield.

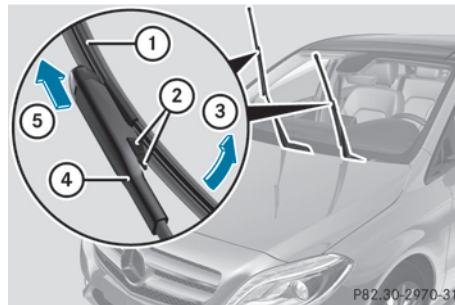

- ▶ Press both release clips ②.
- ▶ Fold wiper blade ① in the direction of arrow ③ away from wiper arm ④.
- ▶ Remove wiper blade ① in the direction of arrow ⑤.

Installing the wiper blades

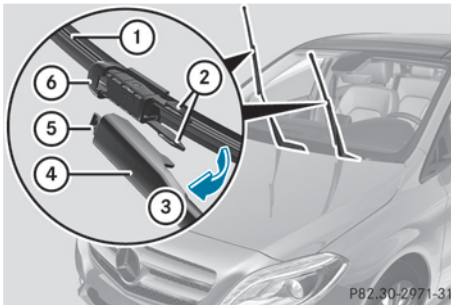

- ▶ Position new wiper blade ① with recess ⑥ on lug ⑤.
- ▶ Fold wiper blade ① in the direction of arrow ③ onto the wiper arm, until retaining clips ② engage in bracket ④.
- ▶ Make sure that wiper blade ① is seated correctly.
- ▶ Fold the wiper arm back onto the windshield.

- ▶ Hold wiper arm ① and press wiper blade ② in the direction of the arrow until it releases.
- ▶ Remove wiper blade ②.

Installing a wiper blade

- ▶ Place new wiper blade ② onto wiper arm ①.
- ▶ Hold wiper arm ① and press wiper blade ② in the opposite direction to the arrow until it engages.
- ▶ Make sure that wiper blade ② is seated correctly.
- ▶ Position wiper blade ② parallel to wiper arm ①.
- ▶ Fold wiper arm ① back onto the rear window.

Replacing the rear window wiper blade

Removing a wiper blade

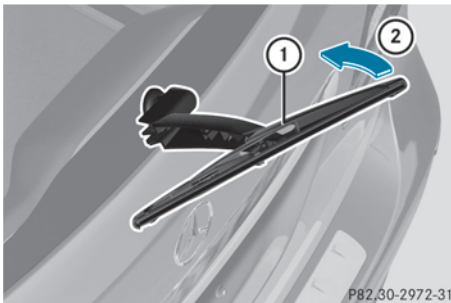

- ▶ Remove the SmartKey from the ignition lock.
- ▶ Fold wiper arm ① away from the rear window until it engages.
- ▶ Position wiper blade ② at a right angle to wiper arm ①.

Problems with the windshield wipers

Problem	Possible causes/consequences and ► Solutions
The windshield wipers are jammed.	Leaves or snow, for example, may be obstructing the windshield wiper movement. The wiper motor has been deactivated. <ul style="list-style-type: none"> ► For safety reasons, you should remove the SmartKey from the ignition lock. ► Remove the cause of the obstruction. ► Switch the windshield wipers back on.
The windshield wipers fail completely.	The windshield wiper drive is malfunctioning. <ul style="list-style-type: none"> ► Select another wiper speed on the combination switch. ► Have the windshield wipers checked at a qualified specialist workshop.
The windshield washer fluid from the spray nozzles no longer hits the center of the windshield.	The spray nozzles are misaligned. <ul style="list-style-type: none"> ► Have the spray nozzles adjusted at a qualified specialist workshop.

Useful information	122
Overview of climate control systems	122
Operating the climate control systems	126
Setting the air vents	133

Useful information

- i** This Operator's Manual describes all models and all standard and optional equipment of your vehicle available at the time of publication of the Operator's Manual. Country-specific differences are possible. Please note that your vehicle may not be equipped with all features described. This also applies to safety-related systems and functions.
- i** Read the information on qualified specialist workshops: (> page 25).

Overview of climate control systems

Important safety notes

Observe the settings recommended on the following pages. The windows could otherwise fog up.

To prevent the windows from fogging up:

- switch off climate control only briefly
- switch on air-recirculation mode only briefly
- switch on the cooling with air dehumidification function
- switch on the defrost windshield function briefly, if required

The automatic climate control regulates the temperature and the humidity of the vehicle interior and filters out undesirable substances from the air.

Automatic climate control/dual-zone automatic climate control is only operational when the engine is running. Optimum operation is only achieved with the side windows and panorama roof with power tilt/sliding panel closed.

The residual heat function can only be activated or deactivated with the ignition switched off (> page 132).

- i** Ventilate the vehicle for a brief period during warm weather, e.g. using the convenience opening feature (> page 84).

This will speed up the cooling process and the desired vehicle interior temperature will be reached more quickly.

- i** The integrated filter filters out most particles of dust and soot and completely filters out pollen. With dual-zone automatic climate control, gaseous pollutants and odors will also be reduced. A clogged filter reduces the amount of air supplied to the vehicle interior. For this reason, you should always observe the interval for replacing the filter, which is specified in the Maintenance Booklet. As it depends on environmental conditions, e.g. heavy air pollution, the interval may be shorter than stated in the Maintenance Booklet.
- i** It is possible that the dehumidification function of the climate control system may be activated automatically an hour after the SmartKey has been removed. The vehicle is then ventilated for 30 minutes.

Control panel for climate control

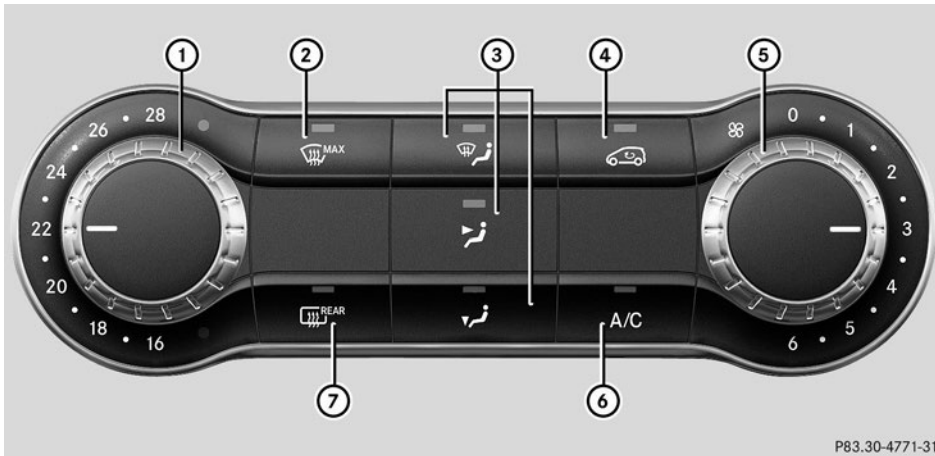

P83.30-4771-31

- ① To set the temperature (▷ page 128)
- ② To defrost the windshield (▷ page 130)
- ③ To set the air distribution (▷ page 129)
- ④ To activate/deactivate air-recirculation mode (▷ page 132)
- ⑤ To set the airflow (▷ page 129)
- ⑥ To switch cooling with air dehumidification on/off (▷ page 126)
- ⑦ To switch the rear window defroster on/off (▷ page 130)

Notes on using climate control

Automatic climate control

The following contains notes and recommendations on optimum use of the automatic climate control.

- Switch on the air-conditioning system by turning control knob ⑤ clockwise to the desired position (except position 0).
- Set the temperature to 22 °C.
- **Recommendation for preventing fogged up windows with low outside temperatures or rain:** switch on for the air distribution and switch and off if possible (▷ page 129). In air-recirculation mode, switch off (▷ page 132).

Set airflow control ⑤ to a setting between 3 and 6 (▷ page 129).

- **Recommendation for rapid cooling or heating of the vehicle interior:** briefly set airflow control ⑤ to a setting between 3 and 6 (▷ page 129).
- **Recommendation for a constant vehicle interior temperature:** set airflow control ⑤ to a setting between 1 and 3 (▷ page 129).
- **Recommendation for air distribution in the winter:** set and (▷ page 129).
- **Recommendation for air distribution in the summer:** set or and (▷ page 129).

- Only use the "Windshield defrosting" function briefly until the windshield is clear again.

- Only use air-recirculation mode briefly, e.g. if there are unpleasant outside odors or when in a tunnel. The windows could otherwise fog up, since no fresh air is drawn into the vehicle in air-recirculation mode.
- **Vehicles with COMAND:** if you change the settings of the climate control system, the climate status display appears for three seconds at the bottom of the screen in the COMAND display. See also the separate COMAND operating instructions. You will see the current settings of the various climate control functions.

ECO start/stop function

During automatic engine switch-off, the ECO start/stop function only operates at a reduced capacity. If you require the full climate control output, you can switch off the ECO start/stop function by pressing the ECO button (▷ page 140).

Control panel for dual-zone automatic climate control

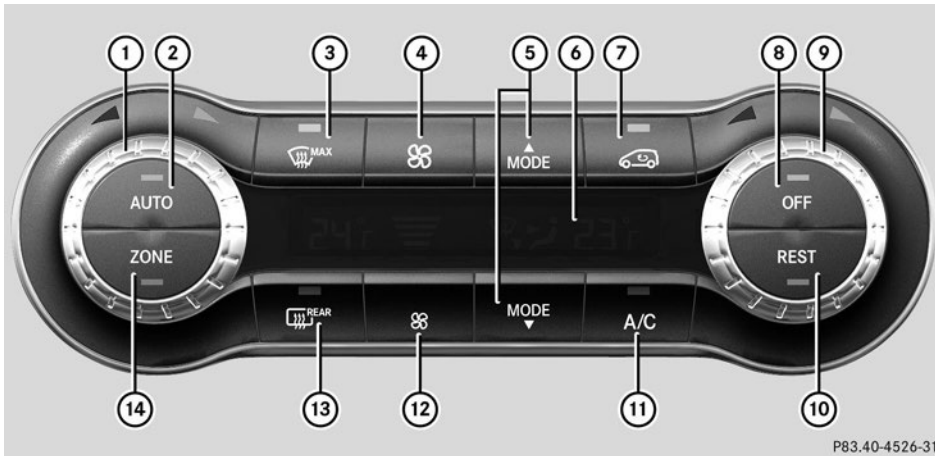

- ① To set the temperature, left (▷ page 128)
- ② To set climate control to automatic (▷ page 128)
- ③ To defrost the windshield (▷ page 130)
- ④ To increase the airflow (▷ page 129)
- ⑤ To set the air distribution (▷ page 129)
- ⑥ Display
- ⑦ To activate/deactivate air-recirculation mode (▷ page 132)
- ⑧ To switch climate control on/off (▷ page 126)
- ⑨ To set the temperature, right (▷ page 128)
- ⑩ To switch the residual heat function on/off (▷ page 132)
- ⑪ To switch cooling with air dehumidification on/off (▷ page 126)
- ⑫ To reduce the airflow (▷ page 129)
- ⑬ To switch the rear window defroster on/off (▷ page 130)
- ⑭ To switch the ZONE function on/off (▷ page 129)

Notes on using dual-zone automatic climate control

Automatic climate control

The following contains instructions and recommendations to enable you to get the most out of your automatic climate control.

- Activate climate control using the **AUTO** and **A/C** buttons. The indicator lamps in the **AUTO** and **A/C** buttons light up.
- Set the temperature to 22 °C.
- Only use the "Windshield defrosting" function briefly until the windshield is clear again.
- Only use air-recirculation mode briefly, e.g. if there are unpleasant outside odors or when in a tunnel. The windows could otherwise fog up, since no fresh air is drawn into the vehicle in air-recirculation mode.
- Use the ZONE function to adopt the temperature settings on the driver's side

for the front-passenger side as well. The indicator lamp in the **ZONE** button goes out.

- Use the residual heat function if you want to heat or ventilate the vehicle interior when the ignition is switched off. The residual heat function can only be activated or deactivated with the ignition switched off.
- **Vehicles with COMAND:** if you change the settings of the climate control system, the climate status display appears for three seconds at the bottom of the screen in the COMAND display. See also the separate COMAND operating instructions. You will see the current settings of the various climate control functions.

ECO start/stop function

During automatic engine switch-off, the ECO start/stop function only operates at a reduced capacity. If you require the full climate control output, you can switch off the ECO start/stop function by pressing the ECO button (▷ page 140).

Operating the climate control systems

Switching climate control on/off

General notes

When the climate control is switched off, the air supply and air circulation are also switched off. The windows could fog up. Therefore, switch off climate control only briefly

Automatic climate control

- ▶ Turn the SmartKey to position **2** in the ignition lock (▷ page 137).
- ▶ **To switch on:** turn control **5** clockwise to the desired position (except position **0**) (▷ page 123).
- ▶ **To switch off:** turn control **5** counter-clockwise to position **0** (▷ page 123).

Dual-zone automatic climate control

- ▶ Turn the SmartKey to position **2** in the ignition lock (▷ page 137).
- ▶ **To switch on:** press the **AUTO** button. The indicator lamp in the **AUTO** button lights up. Airflow and air distribution are set to automatic mode.

or

- ▶ Press the **OFF** button. The indicator lamp in the **OFF** button goes out. The previously selected settings are restored.
- ▶ **To switch off:** press the **OFF** button. The indicator lamp in the **OFF** button lights up.

- i** Dual-zone automatic climate control: switch on climate control primarily using the **AUTO** button.

Activating/deactivating cooling with air dehumidification

General notes





If you deactivate the "Cooling with air-dehumidification" function, the air inside the vehicle will not be cooled. The air inside the vehicle will also not be dehumidified. The windows can fog up more quickly. Therefore, only deactivate the "Cooling with air-dehumidification" function briefly.

The "Cooling with air dehumidification" function is only available when the engine is running. The air inside the vehicle is cooled

and dehumidified according to the temperature selected.

Condensation may drip from the underside of the vehicle when it is in cooling mode. This is normal and not a sign that there is a malfunction.

Activating/deactivating

- ▶ **To activate:** press the  button.
The indicator lamp in the  button lights up.
- ▶ **To deactivate:** press the  button.
The indicator lamp in the  button goes out. The "Cooling with air dehumidification" function has a delayed switch-off feature.

Problems with the "Cooling with air dehumidification" function

Problem	Possible causes/consequences and ► Solutions
The indicator lamp in the  button flashes three times or remains off. The "Cooling with air dehumidification" function cannot be switched on.	Cooling with air dehumidification has been deactivated due to a malfunction. ► Visit a qualified specialist workshop.

Setting climate control to automatic

General notes



The automatic function is only available in conjunction with dual-zone automatic climate control.



In automatic mode, the set temperature is maintained automatically at a constant level. The system automatically regulates the temperature of the dispensed air, the airflow and the air distribution.

The automatic mode functions optimally when the "Cooling with air dehumidification" function is activated. If necessary, cooling with air dehumidification can be deactivated.



If you deactivate the "Cooling with air-dehumidification" function, the air inside the vehicle will not be cooled. The air inside the vehicle will also not be dehumidified. The windows can fog up more quickly. Therefore, only deactivate the "Cooling with air-dehumidification" function briefly.

Setting climate control to automatic

- Turn the SmartKey to position **2** in the ignition lock (▷ page 137).
- Set the desired temperature.
- **To activate:** press the  button. The indicator lamp in the  button lights up. Automatic air distribution and airflow are activated.

- **To switch to manual mode:** press the  or  button.

or

- Press the  or  button. The indicator lamp in the  button goes out. Automatic air distribution and airflow are deactivated.

Setting the temperature



Automatic climate control

You can set the temperature for the entire vehicle.

- Turn the SmartKey to position **2** in the ignition lock (▷ page 137).
- **To increase/reduce:** turn control  clockwise or counter-clockwise (▷ page 123). Only change the temperature setting in small increments. Start at 22 °C.

Dual-zone automatic climate control



Different temperatures can be set for the driver's and front-passenger sides.

- Turn the SmartKey to position **2** in the ignition lock (▷ page 137).
- **To increase/reduce:** turn control  or  clockwise or counter-clockwise (▷ page 125). Only change the temperature setting in small increments. Start at 22 °C.

Setting the air distribution



Automatic climate control

Air distribution settings

-  Directs air through the defroster vents
-  Directs air through the center and side air vents
-  Directs air through the footwell air vents





i You can also activate several air distribution settings simultaneously. To do this, press multiple air distribution buttons. The air is then directed through various vents.

Setting the air distribution

- ▶ Turn the SmartKey to position **2** in the ignition lock (▷ page 137).
- ▶ Press one or more of the , ,  buttons. The corresponding indicator lamp lights up briefly.



Dual-zone automatic climate control

Air distribution settings

-  Directs air through the defroster vents
-  Directs air through the center and side air vents
-  Directs air through the footwell air vents
-  Directs air through the defroster, center and side air vents
-  Directs air through the defroster and footwell vents

i Regardless of the air distribution setting, airflow is always directed through the side air vents. The side air vents can only be closed if the adjusters are turned clockwise until they engage.

Setting the air distribution



- ▶ Turn the SmartKey to position **2** in the ignition lock (▷ page 137).
- ▶ Press the  or  button repeatedly until the desired symbol appears in the display.

Setting the airflow

Automatic climate control





- ▶ Turn the SmartKey to position **2** in the ignition lock (▷ page 137).
- ▶ **To increase/reduce:** turn control  clockwise or counter-clockwise (▷ page 123).

Dual-zone automatic climate control

- ▶ Turn the SmartKey to position **2** in the ignition lock (▷ page 137).
- ▶ **To increase/reduce:** press the  or  button.

Switching the ZONE function on/off

This function is only available with dual-zone automatic climate control.



- ▶ **To activate:** press the  button. The indicator lamp in the  button lights up. The temperature setting for the driver's side is not adopted for the front-passenger side.
- ▶ **To deactivate:** press the  button. The indicator lamp in the  button goes out. The temperature setting for the driver's side is adopted for the front-passenger side.

Defrosting the windshield

You can use this function to defrost the windshield or to defrost the inside of the windshield and the side windows.

i You should only select the "Windshield defrosting" function until the windshield is clear again.

▶ Turn the SmartKey to position **2** in the ignition lock (▷ page 137).



▶ **To activate:** press the  button. The indicator lamp in the  button lights up.



The climate control system switches to the following functions:

- high airflow
- high temperature
- air distribution to the windshield and front side windows
- air-recirculation mode off

i The "Windshield defrosting" function automatically sets the blower output to the optimum defrosting effect. As a result, the airflow may increase or decrease automatically after the button is pressed.

i You can adjust the blower output manually while the "Windshield defrosting" function is in operation:

- Automatic climate control: turn airflow control  clockwise or counter-clockwise (▷ page 123).
- Dual-zone automatic climate control: press the  or  button.

▶ **To deactivate:** press the  button. The indicator lamp in the  button goes out. The previously selected settings are restored. Air-recirculation mode remains deactivated.



or

▶ Dual-zone automatic climate control: press the **AUTO** button.

The indicator lamp in the  button goes out. Airflow and air distribution are set to automatic mode.

or



▶ Automatic climate control: turn temperature control  clockwise or counter-clockwise (▷ page 123).

Dual-zone automatic climate control: turn temperature control  or  clockwise or counter-clockwise (▷ page 125).

Defrosting the windows



Windows fogged up on the inside

Automatic climate control

- ▶ Activate the  "Cooling with air dehumidification" function.
- ▶ If the windows continue to fog up, activate the  "Windshield defrosting" function.



i You should only select this setting until the windshield is clear again.

Dual-zone automatic climate control

- ▶ Activate the  "Cooling with air dehumidification" function.
- ▶ Activate automatic mode **AUTO**.
- ▶ If the windows continue to fog up, activate the  "Windshield defrosting" function.

i You should only select this setting until the windshield is clear again.

Windows fogged up on the outside

- ▶ Activate the windshield wipers.
- ▶ Set the air distribution to  or .

i You should only select this setting until the windshield is clear again.



Rear window defroster

General notes

The rear window defroster has a high current draw. You should therefore switch it off as soon as the rear window is clear. Otherwise, the rear window defroster switches off automatically after several minutes.

If the battery voltage is too low, the rear window defroster may switch off.

Activating/deactivating

- ▶ Turn the SmartKey to position **2** in the ignition lock (> page 137).
- ▶ Press the  button.
The indicator lamp in the  button lights up or goes out.

Problems with the rear window defroster

Problem	Possible causes/consequences and ► Solutions
The rear window defroster has deactivated prematurely or cannot be activated.	The battery has not been sufficiently charged. ► Switch off any consumers that are not required, e.g. reading lamps, interior lighting or the seat heating. When the battery is sufficiently charged, the rear window defroster can be activated again.

Activating/deactivating air-recirculation mode



General notes

You can deactivate the flow of fresh air if unpleasant odors are entering the vehicle from outside. The air already inside the vehicle will then be recirculated.

If you switch on air-recirculation mode, the windows can fog up more quickly, in particular at low temperatures. Only use air-recirculation mode briefly to prevent the windows from fogging up.



The operation of air-recirculation mode is the same for all control panels.

Activating/deactivating

- Turn the SmartKey to position **2** in the ignition lock (► page 137).
- **To activate:** press the  button. The indicator lamp in the  button lights up.

i Air-recirculation mode is activated automatically at high outside temperatures. When air-recirculation mode is activated automatically, the indicator lamp in the  button is not lit.

Outside air is added after about 30 minutes.

- **To deactivate:** press the  button. The indicator lamp in the  button goes out.

i Air-recirculation mode deactivates automatically:

- after approximately five minutes at outside temperatures below about 5 °C
- after approximately five minutes if the "Cooling with air dehumidification" function is deactivated
- after approximately 30 minutes at outside temperatures above approximately 5 °C if the "Cooling with air dehumidification" function is activated

Activating/deactivating the residual heat function

General notes

The residual heat function is only available in vehicles for Canada with automatic climate control.

It is possible to make use of the residual heat of the engine to continue heating the vehicle for approximately 30 minutes after the engine has been switched off. The heating time depends on the temperature that has been set.

- i** The blower will run at a low speed regardless of the airflow setting.
- i** If you activate the residual heat function at high temperatures, only the ventilation will be activated. The blower runs at medium speed.

Activating/deactivating

- ▶ Turn the SmartKey to position **0** in the ignition lock or remove it (▷ page 137).
- ▶ **To activate:** press the **REST** button. The indicator lamp in the **REST** button lights up.
- ▶ **To deactivate:** press the **REST** button. The indicator lamp in the **REST** button goes out.

i Residual heat is deactivated automatically:

- after approximately 30 minutes
- when the ignition is switched on
- if the battery voltage drops

Setting the air vents

Important safety notes

WARNING

Very hot or very cold air can flow from the air vents. This could result in burns or frostbite in the immediate vicinity of the air vents. There is a risk of injury.

Make sure that all vehicle occupants always maintain a sufficient distance to the air outlets. If necessary, redirect the airflow to another area of the vehicle interior.

In order to ensure the direct flow of fresh air through the air vents into the vehicle interior, please observe the following notes:

- keep the air inlet between the windshield and the hood free of blockages, such as ice, snow or leaves.
 - never cover the air vents or air intake grilles in the vehicle interior.
- i** You can move the adjusters for the air vents vertically or horizontally to set the direction of the airflow.
- i** For optimal climate control in the vehicle, open the air vents completely and set the adjusters to the central position.

Setting the center air vents

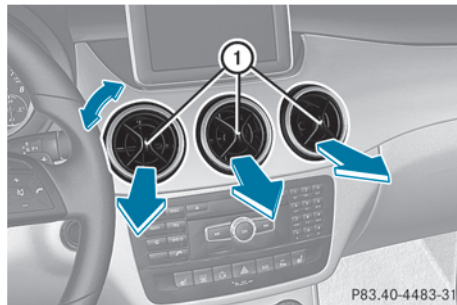

- ▶ **To open the center air vent:** turn the adjuster in one of center air vents ① counter-clockwise.
- ▶ **To close the center air vent:** turn the adjuster in one of center air vents ① clockwise until it engages.

Setting the side air vents

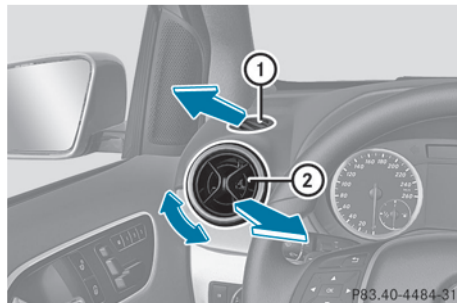

- ① Side window defroster vent
- ② Side air vent

- ▶ **To open a side air vent:** turn the adjuster in side air vent ② counter-clockwise.
- ▶ **To close a side air vent:** turn the adjuster in side air vent ② clockwise until it engages.

Setting the rear-compartment air vents

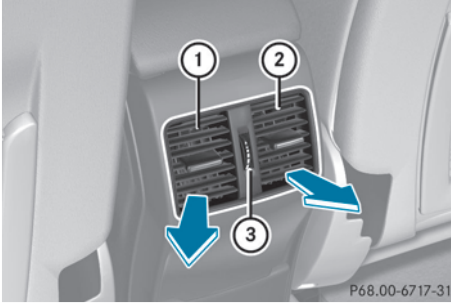

- ① Rear-compartment air vent, left
 - ② Rear-compartment air vent, right
 - ③ Rear-compartment air vent thumbwheel
- **To open/close:** turn thumbwheel ③ up or down.

Useful information	136
Notes on breaking-in a new vehicle	136
Driving	136
Automatic transmission	143
Refueling	150
Parking	152
Driving tips	155
Driving systems	160

Useful information

- i** This Operator's Manual describes all models and all standard and optional equipment of your vehicle available at the time of publication of the Operator's Manual. Country-specific differences are possible. Please note that your vehicle may not be equipped with all features described. This also applies to safety-related systems and functions.
- i** Read the information on qualified specialist workshops: (▷ page 25).

Notes on breaking-in a new vehicle

Important safety notes

New and replaced brake pads and discs only reach their optimum braking effect after several hundred kilometers of driving. Compensate for this by applying greater force to the brake pedal.

The first 1000 miles (1500 km)

The more you look after the engine when it is new, the more satisfied you will be with its performance in the future.

- You should therefore drive at varying vehicle and engine speeds for the first 1000 miles (1500 km).
- Avoid heavy loads, e.g. driving at full throttle, during this period.
- Change gear in good time, before the tachometer needle is $\frac{2}{3}$ of the way to the red area of the tachometer.
- Do not manually shift to a lower gear to brake the vehicle.
- If possible, do not depress the accelerator pedal past the point of resistance (kickdown).
- Ideally, for the first 1000 miles (1500 km), drive in program **E**.

After 1,000 miles (1,500 km), you can increase the engine speed gradually and bring the vehicle to full speed.

- i** You should also observe these notes on breaking-in if the engine or parts of the drive train on your vehicle have been replaced.
- i** Always observe the respective speed limits.

Driving

Important safety notes

WARNING

Objects in the driver's footwell can restrict the pedal travel or obstruct a depressed pedal. The operating and road safety of the vehicle is jeopardized. There is a risk of an accident. Make sure that all objects in the vehicle are stowed correctly, and that they cannot enter the driver's footwell. Install the floormats securely and as specified in order to ensure sufficient clearance for the pedals. Do not use loose floormats and do not place floormats on top of one another.

WARNING

Unsuitable footwear can hinder correct usage of the pedals, e.g.:

- shoes with thick soles
- shoes with high heels
- slippers

There is a risk of an accident.

Wear suitable footwear to ensure correct usage of the pedals.

WARNING

If you switch off the ignition while driving, safety-relevant functions are only available with limitations, or not at all. This could affect, for example, the power steering and the brake boosting effect. You will require considerably

more effort to steer and brake. There is a risk of an accident.

Do not switch off the ignition while driving.

WARNING

If the parking brake has not been fully released when driving, the parking brake can:

- overheat and cause a fire
- lose its hold function.

There is a risk of fire and an accident. Release the parking brake fully before driving off.

! Warm up the engine quickly. Do not use the engine's full performance until it has reached operating temperature.

Only shift the automatic transmission to the desired drive position when the vehicle is stationary.

Where possible, avoid spinning the drive wheels when pulling away on slippery roads. You could otherwise damage the drive train.

Key positions

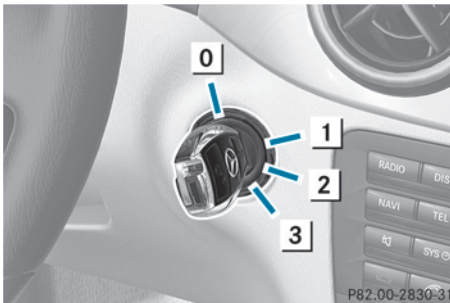

- 0** To remove the SmartKey (shift the transmission to position **P**)
 - 1** Power supply for some consumers, such as the windshield wipers
 - 2** Ignition (power supply for all consumers) and drive position
 - 3** To start the engine
- i** The SmartKey can be turned in the ignition lock even if it is not the correct

SmartKey for the vehicle. The ignition is not switched on. The engine cannot be started.

Starting the engine

Important safety notes

WARNING

Combustion engines emit poisonous exhaust gases such as carbon monoxide. Inhaling these exhaust gases leads to poisoning. There is a risk of fatal injury. Therefore never leave the engine running in enclosed spaces without sufficient ventilation.

WARNING

Flammable materials introduced through environmental influence or by animals can ignite if in contact with the exhaust system or parts of the engine that heat up. There is a risk of fire.

Carry out regular checks to make sure that there are no flammable foreign materials in the engine compartment or in the exhaust system.

! Do not depress the accelerator pedal when starting the engine.

i During a cold start, the engine runs at higher speeds to enable the catalytic converter to reach its operating temperature. The sound of the engine may change during this time.

Automatic transmission

- Shift the transmission to position **P**. Transmission position display **P** is shown in the multifunction display.
- i** When the transmission is in position **N**, you can also start the engine with the brake pedal depressed.

Starting procedure

- ▶ Turn the SmartKey to position **3** in the ignition lock (▷ page 137) and release it as soon as the engine is running.

Pulling away

Automatic transmission

i It is only possible to shift the transmission from position **P** to the desired position if you depress the brake pedal. Only then can the parking lock be deactivated. If you do not depress the brake pedal, the DIRECT SELECT lever can still be moved but the parking lock remains engaged.

i If the transmission oil temperature is below -4 °F (-20 °C), you can only shift from position **P** when the engine is running.

- ▶ Depress the brake pedal and keep it depressed.
- ▶ Shift the transmission to position **D** or **R**.
- ▶ Release the brake pedal.
- ▶ Carefully depress the accelerator pedal. The electric parking brake (▷ page 153) is automatically released.

The red  indicator lamp in the instrument cluster goes out.

i The vehicle locks centrally once you have pulled away. The locking knobs in the doors drop down.

You can open the doors from the inside at any time.

You can also deactivate the automatic locking feature (▷ page 205).

i Upshifts take place at higher engine speeds after a cold start. This helps the catalytic converter to reach its operating temperature more quickly.

Hill start assist

Hill start assist helps you when pulling away forwards or in reverse on an uphill gradient. It holds the vehicle for a short time after you have removed your foot from the brake pedal. This gives you enough time to move your foot from the brake pedal to the accelerator pedal and to depress it before the vehicle begins to roll.

WARNING

After a short time, hill start assist will no longer brake your vehicle and it could roll away. There is a risk of an accident and injury. Therefore, quickly move your foot from the brake pedal to the accelerator pedal. Never leave the vehicle when it is held by hill start assist.

- ▶ Remove your foot from the brake pedal. The vehicle is then held for about a second.
- ▶ Pull away.

Hill start assist is not active if:

- you are pulling away on a level road or on a downhill gradient.
- the transmission is in position **N**.
- the electric parking brake is applied.
- ESP® is malfunctioning.

Further information on holding the vehicle stationary on uphill gradients (▷ page 146).

ECO start/stop function

Introduction

The ECO start/stop function switches the engine off automatically if the vehicle is stopped under certain conditions.

The engine starts automatically when the driver wants to pull away again. The ECO start/stop function thereby helps you to reduce the fuel consumption and emissions of your vehicle.

Important safety notes

WARNING

If the engine is switched off automatically and you exit the vehicle, the engine is restarted automatically. The vehicle may begin moving. There is a risk of accident and injury.

If you wish to exit the vehicle, always turn off the ignition and secure the vehicle against rolling away.

General notes



- ① ECO start/stop display (example: color multifunction display)

The ECO start/stop function switches the engine off automatically when the vehicle stops moving, if:

- the **ECO** symbol appears in the multifunction display in vehicles with black and white multifunction display
- the **ECO** symbol appears in green in the multifunction display in vehicles with a color multifunction display.

The stop/start function is automatically activated each time you start the engine with the SmartKey.

If the ECO start/stop function has been manually deactivated (▷ page 140) or a malfunction has caused the system to be deactivated, the **ECO** symbol is not displayed.

Automatic engine switch-off

General notes

The ECO stop/start function is operational and displays the following in the multifunction display:

- the **ECO** symbol in vehicles with a black and white multifunction display
- a green **ECO** symbol in vehicles with a color multifunction display

This is the case if, among other things:

- the indicator lamp in the ECO button is lit green.
- the outside temperature is within the range that is suitable for the system.
- the engine is at normal operating temperature.
- the set temperature for the vehicle interior has been reached.
- the battery is sufficiently charged.
- the system detects that the windshield is not fogged up when the air-conditioning system is switched on.
- the hood is closed.
- the driver's door is closed and the driver's seat belt is fastened.

If not all conditions for an automatic engine switch-off are met:

- the **ECO** symbol does not appear in vehicles with a black and white multifunction display
- a yellow **ECO** symbol appears in vehicles with a color multifunction display

i All of the vehicle's systems remain active when the engine has been stopped automatically.

i The engine can be switched off automatically a maximum of four times (first stop and three subsequent stops) in succession.

In vehicles with a black and white multifunction display, the automatic engine switch-off is then available again after the

ECO symbol appears in the multifunction display.

In vehicles with a color multifunction display, the **ECO** symbol appears in yellow in the multifunction display after the fourth automatic engine start. When the **ECO** symbol is shown in green in the multifunction display, automatic engine switch-off is again possible.

Vehicles with automatic transmission

If the vehicle is braked to a standstill in **D** or **N**, the ECO start/stop function switches off the engine automatically.

- i** The HOLD function can be activated if the engine has been switched off automatically. It is then not necessary to continue applying the brakes during the automatic stop phase. When you depress the accelerator pedal, the engine starts automatically and the braking effect of the HOLD function is deactivated.

Automatic engine start

General notes

The engine starts automatically if:

- you switch off the ECO start/stop function by pressing the ECO button.
- you engage reverse gear **R**.
- the vehicle starts to roll.
- the brake system requires this.
- the temperature in the vehicle interior deviates from the set range.
- the system detects moisture on the windshield when the air-conditioning system is switched on.
- the condition of charge of the battery is too low.
- the driver's seat belt is removed or the driver's door is opened.

Vehicles with automatic transmission

The engine is started automatically if you:

- release the brake pedal when HOLD is not activated and the transmission is in position **D** or **N**.
 - depress the accelerator pedal.
 - move the transmission out of position **P**.
- i** Shifting the transmission to position **P** does not start the engine.

- i** When you shift the transmission from **R** to **D**, the ECO start/stop function is available in the following cases:

- after the **ECO** symbol appears in the multifunction display in vehicles with a black and white multifunction display
- after the **ECO** symbol appears in green in vehicles with a color multifunction display

Deactivating/activating the ECO start/stop function



ECO button

- ▶ **To switch off:** press button **①**. Indicator lamp **②** and the **ECO** symbol in the multifunction display go out.
- ▶ **To switch on:** press button **①**. Indicator lamp **②** lights up.

If all conditions for an automatic engine switch-off are met:

- the **ECO** symbol appears in the multifunction display in vehicles with a black and white multifunction display.
- the **ECO** symbol appears in green in the multifunction display in vehicles with a color multifunction display.

If not all conditions for an automatic engine switch-off are met:

- the **ECO** symbol does not appear in the multifunction display in vehicles with a black and white multifunction display.
- the **ECO** symbol appears in yellow in the multifunction display in vehicles with a color multifunction display.

If this is the case, the ECO start/stop function is not available.

Conditions for the automatic engine switch-off (> page 139).

- ❗ If indicator lamp ② is off, the ECO start/stop function has been deactivated manually or as the result of a malfunction. The engine will then not be switched off automatically when the vehicle stops.

Problems with the engine

Problem	Possible causes/consequences and ► Solutions
The engine does not start.	<p>The HOLD function or DISTRONIC PLUS is activated.</p> <ul style="list-style-type: none"> ► Deactivate the HOLD function (▷ page 171) or DISTRONIC PLUS (▷ page 162). ► Try to start the engine again.
The engine does not start. The starter motor can be heard.	<ul style="list-style-type: none"> • There is a malfunction in the engine electronics. • There is a malfunction in the fuel supply. <ul style="list-style-type: none"> ► Turn the SmartKey back to position 0 in the ignition lock before attempting to start the engine again. ► Try to start the engine again (▷ page 137). Avoid excessively long and frequent attempts to start the engine as these will drain the battery. <p>If the engine does not start after several attempts:</p> <ul style="list-style-type: none"> ► Consult a qualified specialist workshop.
The engine does not start. You cannot hear the starter motor.	<p>The on-board voltage is too low because the battery is too weak or discharged.</p> <ul style="list-style-type: none"> ► Jump-start the vehicle (▷ page 303). <p>If the engine does not start despite attempts to jump-start it:</p> <ul style="list-style-type: none"> ► Consult a qualified specialist workshop, e.g. an authorized Mercedes-Benz Center. <p>The starter motor was exposed to a thermal load that was too high.</p> <ul style="list-style-type: none"> ► Allow the starter motor to cool down for approximately two minutes. ► Try to start the engine again. <p>If the engine still does not start:</p> <ul style="list-style-type: none"> ► Consult a qualified specialist workshop.

Problem	Possible causes/consequences and ► Solutions
The engine is not running smoothly and is misfiring.	<p>There is a malfunction in the engine electronics or in a mechanical component of the engine management system.</p> <ul style="list-style-type: none"> ► Only depress the accelerator pedal slightly. ► Have the cause rectified immediately at a qualified specialist workshop. Otherwise, non-combusted fuel may get into the catalytic converter and damage it.
The coolant temperature display is showing more than 248 °F (120 °C). The coolant warning lamp may also be lit and a warning tone may sound.	<p>The coolant level is too low. The coolant is too hot and the engine is no longer being cooled sufficiently.</p> <ul style="list-style-type: none"> ► Stop as soon as possible and allow the engine and the coolant to cool down. ► Check the coolant level (► page 283). Observe the warning notes as you do so and add coolant if necessary.

Automatic transmission

Important safety notes

WARNING

If the engine speed is above the idling speed and you engage transmission position **D** or **R**, the vehicle could pull away suddenly. There is a risk of an accident.

When engaging transmission position **D** or **R**, always firmly depress the brake pedal and do not simultaneously accelerate.

WARNING

The automatic transmission switches to neutral position **N** when you switch off the engine. The vehicle may roll away. There is a risk of an accident.

After switching off the engine, always switch to parking position **P**. Prevent the parked vehicle from rolling away by applying the parking brake.

DIRECT SELECT lever

Overview of transmission positions

The DIRECT SELECT lever is on the right of the steering column.

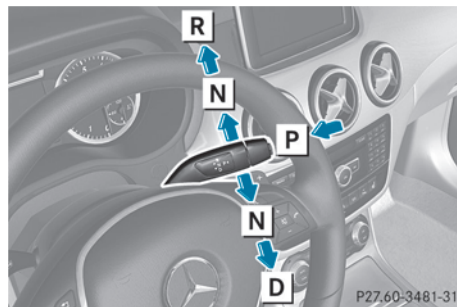

- P** Park position with parking lock
- R** Reverse gear
- N** Neutral
- D** Drive

i The DIRECT SELECT lever always returns to its original position. The current transmission position **P**, **R**, **N** or **D** appears in the transmission position display (► page 144) in the multifunction display.

Transmission position and drive program display

The current transmission position and drive program appear in the multifunction display.



- ① Transmission position display
- ② Drive program display

i The arrows in the transmission position display show how and into which transmission positions you can change using the DIRECT SELECT lever.

! If the transmission position display in the multifunction display is not working, you should pull away carefully to check whether the desired transmission position is engaged. Ideally, you should select transmission position **D** and drive program **E** or **S**.

Engaging park position P

- ▶ Push the DIRECT SELECT lever in the direction of arrow **P**.
Transmission position display **P** is shown in the multifunction display.
- i** When you engage park position **P**, make sure that the transmission position display shows **P** in the multifunction display.
- i** You can only engage park position **P** when the vehicle is stationary.
- i** The automatic transmission shifts into park position **P** automatically:
 - if you open the driver's door while the vehicle is stationary in transmission position **D** or **R**
 - if you open the door while traveling at very low speeds in transmission position **D** or **R**

In addition, a warning tone sounds and a display message is shown.

i Depressing the brake and pushing the DIRECT SELECT lever up or down disengages the parking lock. The transmission is in **N** neutral.

At transmission fluid temperatures below $-4\text{ }^{\circ}\text{F}$ ($-20\text{ }^{\circ}\text{C}$), you can only shift out of park position **P** into another transmission position when the engine is running.

In order to shift from park position **P** directly into **R** or **D**:

- depress the brake pedal and
- push the DIRECT SELECT lever up or down past the first point of resistance

! If the engine speed is too high or the vehicle is moving, do not shift the automatic transmission directly from **D** to **R**, from **R** to **D** or directly to **P**. The automatic transmission could otherwise be damaged.

Engaging reverse gear R

! Only shift the automatic transmission to **R** when the vehicle is stationary.

- i** The ECO start/stop function is not available when reverse gear is engaged. Further information on the ECO start/stop function (> page 139).
- ▶ When the vehicle is stationary, depress the brake pedal.
- ▶ Push the DIRECT SELECT lever up past the first point of resistance.

Shifting to neutral N

- ▶ When the vehicle is stationary, depress the brake pedal.
- ▶ Push the DIRECT SELECT lever up or down to the first point of resistance.

If the engine has been switched off, the automatic transmission automatically shifts to **N**.

Remaining in neutral N

If the automatic transmission is to remain in neutral **N**, e.g. for washing the vehicle in car washes with a towing device, please observe the following instructions:

⚠ WARNING

If children are left unsupervised in the vehicle, they could:

- open the doors, thus endangering other people or road users.
- get out and disrupt traffic.
- operate the vehicle's equipment.

Additionally, children could set the vehicle in motion if, for example, they:

- release the parking brake.
- shifting the automatic transmission out of park position **P**
- Start the engine.

There is a risk of an accident and injury.

When leaving the vehicle, always take the SmartKey with you and lock the vehicle. Never leave children or animals unattended in the vehicle. Always keep the SmartKey out of reach of children.

- Make sure that the ignition is switched on.
- When the vehicle is stationary, depress the brake pedal and keep it depressed.
- Shift to neutral **N**.
- Release the brake pedal.
- If the electric parking brake is engaged, release it.
- Switch off the ignition and leave the SmartKey in the ignition lock.

Engaging drive position D

- ▶ When the vehicle is stationary, depress the brake pedal.
- ▶ Push the DIRECT SELECT lever down past the first point of resistance.

Transmission positions**P****Park position**

Do not shift the transmission into position **P** unless the vehicle is stationary (▷ page 152). The parking lock should not be used as a brake when parking. Always apply the electronic parking brake in addition to the parking lock in order to secure the vehicle.

If the vehicle electronics are malfunctioning, the transmission may be locked in position **P**.

Have the vehicle electronics checked immediately at a qualified specialist workshop.

R**Reverse gear**

Only shift the transmission to **R** when the vehicle is stationary.

N**Neutral**

No power is transmitted from the engine to the drive wheels.

Releasing the brakes will allow you to move the vehicle freely, e.g. to push it or tow it.

If ESP[®] is deactivated or faulty: only shift the transmission to position **N** if the vehicle is in danger of skidding, e.g. on icy roads.

When you switch off the engine, the automatic transmission automatically shifts into neutral **N**.

D**Drive**

The automatic transmission changes gear automatically. All forward gears are available.

Changing gear

The automatic transmission shifts to the individual gears automatically when it is in transmission position **D**. This automatic gearshifting behavior is determined by:

- the selected drive program (▷ page 146)
- the position of the accelerator pedal
- the road speed

Driving tips

Holding the vehicle stationary on uphill gradients

WARNING

If the clutch overheats, the electronic management system is automatically deactivated. This interrupts the power transmission. The vehicle may, for example, roll backwards on gradients. There is a risk of an accident.

Never hold the vehicle stationary on uphill gradients by depressing the accelerator.

The clutch may overheat if you hold the vehicle stationary on uphill gradients by depressing the accelerator pedal. If the clutch overheats, a warning tone sounds. The **Stop Vehicle Shift to P Leave Engine Running** display message appears in the multifunction display. You will only be able to continue your journey once the clutch has cooled down and the display message in the multifunction display has disappeared.

Never hold the vehicle stationary on uphill gradients by depressing the accelerator. Instead, only ever hold the vehicle stationary on uphill gradients by:

- depressing the brake pedal
- activating the HOLD function
- engaging the electric parking brake

Kickdown

Use kickdown for maximum acceleration:

- ▶ Depress the accelerator pedal beyond the pressure point.
The automatic transmission shifts to a lower gear depending on the engine speed.
- ▶ Ease off the accelerator pedal once the desired speed is reached.
The automatic transmission shifts back up.

Rocking the vehicle free

Shifting the transmission repeatedly between gears **D** and **R** may help to free the vehicle if it has become stuck in slush or snow. The vehicle's engine management system limits the speed to a maximum of 5 mph (9 km/h) when shifting back and forth. To shift back and forth between transmission positions **D** and **R**, move the selector lever up and down beyond the pressure point.

Program selector button

General notes

The program selector button allows you to choose between drive programs with different driving characteristics.



Example: program selector button

E Economy	Comfortable, economical driving
S Sport	Sporty driving style
M Manual	Manual gear shifting

Only change from automatic drive program **E** or **S** to manual drive program **M** when the vehicle is stationary.

▶ Press program selector button ① repeatedly until the letter for the desired gearshift program appears in the multifunction display.

① The automatic transmission shifts to automatic drive program **E** each time the engine is started.

① For further information on the automatic drive program, see (▷ page 147).

Steering wheel paddle shifters

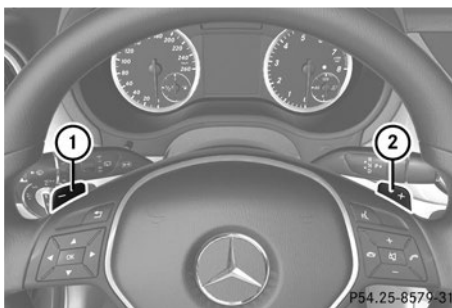

① Left steering wheel paddle shifter (shifts down)

② Right steering wheel paddle shifter (shifts up)

In drive program **M**, you can change gear yourself using the steering wheel paddle shifters.

If you pull the left or right steering wheel paddle shifter when in automatic drive program **E** or **S**, the automatic transmission shifts into drive program **M** for a limited time. Depending on which paddle shifter is pulled,

the automatic transmission immediately shifts into the next gear down or up.

① You can only change gear with the steering wheel paddle shifters when the transmission is in position **D**.

① For further information on the manual drive program, see (▷ page 147).

Automatic drive program

Drive program **E** is characterized by the following:

- comfort-oriented engine settings
- optimal fuel consumption resulting from the automatic transmission shifting up sooner
- the vehicle pulling away more gently in forward and reverse gears, unless the accelerator pedal is depressed fully
- increased sensitivity. This improves driving stability on slippery road surfaces, for example
- the automatic transmission shifting up sooner. This results in the vehicle being driven at lower engine speeds and the wheels being less likely to spin

Drive program **S** is characterized by the following:

- sporty engine settings
- the automatic transmission shifting up later
- the fuel consumption possibly being higher as a result of the later automatic transmission shift points

Manual drive program

Introduction

In manual drive program **M**, you can change gear yourself by using the steering wheel paddle shifters. For this, the transmission must be in position **D**. The gear currently

selected and engaged is shown in the multifunction display.

Manual drive program **M** differs from drive programs **E** and **S** with regard to spontaneity, responsiveness and smoothness of gear changes.

Gear	Driving situations
3	You can use the engine's braking effect
2	You can use the braking effect of the engine on downhill gradients and for driving: <ul style="list-style-type: none"> • on steep mountain roads • in mountainous terrain • in arduous conditions
1	To use the braking effect of the engine on extremely steep downhill gradients and on long downhill stretches

Switching on the manual drive program

Activating permanently

- ▶ Press the program selector button (▷ page 146) repeatedly until **M** appears in the multifunction display. Manual drive program **M** remains active until drive program **E** or **S** is engaged.

Activating temporarily

- ▶ Pull the right or left steering wheel paddle shifter (▷ page 147). **M** is shown in the multifunction display. Manual drive program **M** is temporarily active. Depending on which paddle shifter is pulled, the automatic transmission immediately shifts into the next gear down or up.
- i** When manual drive program **M** is activated via the steering wheel paddle shifters, the temporarily active manual drive program **M** will be deactivated automatically after a limited time, if the driving situation permits. In this case, the

automatic transmission shifts into the automatic drive program that was last engaged, i.e. **E** or **S**. When driving on downhill gradients, the temporarily active manual drive program **M** will only be deactivated if the accelerator pedal is depressed while the vehicle is rolling downhill.

Upshifting

- ▶ Pull the right-hand steering wheel paddle shifter (▷ page 147). The automatic transmission shifts up to the next gear.
- i** To prevent engine damage the automatic transmission shifts up automatically:
 - if the maximum engine speed on the currently engaged gear is reached and
 - you continue to accelerate.

Shift recommendation

The gearshift recommendations assist you in adopting an economical driving style. The recommended gear is shown in the multifunction display.



- ▶ Shift to recommended gear ② according to gearshift recommendation ① when shown in the multifunction display of the instrument cluster.

Downshifting

- ▶ Pull the left-hand steering wheel paddle shifter (▷ page 147). The automatic transmission shifts down to the next gear.

- i** If you slow down or stop without shifting down, the automatic transmission automatically shifts down.
- i** For maximum acceleration, pull the left-hand steering wheel paddle shifter until the transmission selects the optimum gear for the current speed.
- i** If the engine exceeds the maximum engine speed when shifting down, the automatic transmission protects against engine damage by not shifting down.

Kickdown

You can also use kickdown for maximum acceleration in manual drive program **M**.

- ▶ Depress the accelerator pedal beyond the pressure point.
The automatic transmission shifts to a lower gear depending on the engine speed.
- ▶ Shift back up once the desired speed is reached.
- i** During kickdown, you cannot change gear using the steering wheel paddle shifters.
- i** If you apply full throttle, the automatic transmission shifts up to the next gear when the maximum engine speed is reached. This prevents the engine from overrevving.

Switching off the manual drive program

- ▶ Press the program selector button (▷ page 146) repeatedly until **E** or **S** appears in the multifunction display.

Deactivating the temporary manual drive program

- ▶ Pull and hold the right-hand steering wheel paddle shifter until the automatic transmission shifts into the last active automatic drive program: **E** or **S**.
- i** If manual drive program **M** is deactivated, the automatic transmission in automatic drive program **E** or **S** may shift from the

current gear into a higher or lower gear. This is dependent on the position of the accelerator pedal, speed and load.

Problems with the transmission

Problem	Possible causes/consequences and ► Solutions
The transmission has problems shifting gear.	The transmission is losing oil. ► Have the transmission checked at a qualified specialist workshop immediately.
The acceleration ability is deteriorating. The transmission no longer shifts into all of the gears. Reverse gear can no longer be engaged.	The transmission is in emergency mode. ► Stop the vehicle. ► Shift the transmission to position P . ► Switch off the engine. ► Wait at least 10 seconds before restarting the engine. ► Shift the transmission to position D . ► Have the transmission checked at a qualified specialist workshop immediately.

Refueling

Important safety notes

WARNING

Fuel is highly flammable. If you handle fuel incorrectly, there is a risk of fire and explosion.

You must avoid fire, open flames, creating sparks and smoking. Switch off the engine and, if applicable, the auxiliary heating before refueling.

WARNING

Fuel is poisonous and hazardous to health. There is a risk of injury.

You must make sure that fuel does not come into contact with your skin, eyes or clothing and that it is not swallowed. Do not inhale fuel vapors. Keep fuel away from children.

If you or others come into contact with fuel, observe the following:

- Wash away fuel from skin immediately using soap and water.
- If fuel comes into contact with your eyes, immediately rinse them thoroughly with

clean water. Seek medical assistance without delay.

- If fuel is swallowed, seek medical assistance without delay. Do not induce vomiting.
- Immediately change out of clothing which has come into contact with fuel.

WARNING

Electrostatic buildup can create sparks and ignite fuel vapors. There is a risk of fire and explosion.

Always touch the vehicle body before opening the fuel filler flap or touching the fuel pump nozzle. Any existing electrostatic buildup is thereby discharged.

- ❗ Do not use diesel to refuel vehicles with a gasoline engine. Do not switch on the ignition if you accidentally refuel with the wrong fuel. Otherwise, the fuel will enter the fuel system. Even small amounts of the wrong fuel could result in damage to the fuel system and the engine. Notify a qualified specialist workshop and have the fuel tank and fuel lines drained completely.

- ❗ Overfilling the fuel tank could damage the fuel system.
- ❗ Take care not to spill any fuel on painted surfaces. You could otherwise damage the paintwork.
- ❗ Use a filter when refueling from a fuel can. Otherwise, the fuel lines and/or injection system could be blocked by particles from the fuel can.

Do not get into the vehicle again during the refueling process. Otherwise, electrostatic charge could build up again.

If you overfill the fuel tank, fuel could spray out when the fuel pump nozzle is removed.

For further information on fuel and fuel quality (> page 348).

Refueling

Opening/closing the fuel filler flap

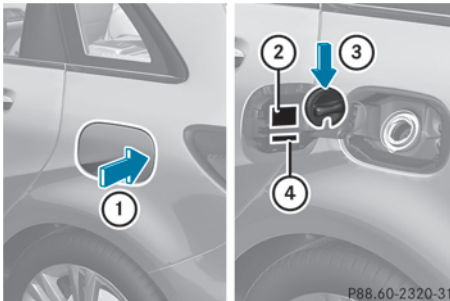

- ① To open the fuel filler flap
- ② Tire pressure table
- ③ To insert the fuel filler cap
- ④ Fuel type to be used



The fuel filler flap is unlocked or locked automatically when you open or close the vehicle with the SmartKey.

The position of the fuel filler cap is displayed  in the instrument cluster. The arrow on the filling pump indicates the side of the vehicle.

Opening

- ▶ Switch the engine off.
- ▶ Remove the SmartKey from the ignition lock.
- ▶ Press the fuel filler flap in the direction of arrow ①.
The fuel filler flap swings up.
- ▶ Turn the fuel filler flap counter-clockwise and remove it.
- ▶ Insert the fuel filler cap into holder on the inside of fuel filler flap ③.
- ▶ Completely insert the filler neck of the fuel pump nozzle into the tank, hook in place and refuel.
- ▶ Only fill the tank until the pump nozzle switches off.
- ❗ Do not add any more fuel after the pump stops filling for the first time. Otherwise, fuel may leak out.

Closing

- ▶ Replace the cap on the filler neck and turn clockwise until it engages audibly.
- ▶ Close the fuel filler flap.
- ❗ Close the fuel filler flap before locking the vehicle.
- ❗ If you are driving with the fuel filler cap open, the  reserve fuel warning lamp flashes. A message appears in the multifunction display (> page 225).
In addition, the  Check Engine warning lamp may light up (> page 245).
For further information on warning and indicator lamps in the instrument cluster, see (> page 245).

Problems with fuel and the fuel tank	
Problem	Possible causes/consequences and ► Solutions
Fuel is leaking from the vehicle.	<p>The fuel line or the fuel tank is faulty.</p> <p> WARNING</p> <p>Risk of explosion or fire.</p> <ul style="list-style-type: none"> ► Turn the SmartKey to position 0 in the ignition lock immediately and remove it (▷ page 137). ► Do not restart the engine under any circumstances. ► Consult a qualified specialist workshop.
The fuel filler flap cannot be opened.	<p>The fuel filler flap is not unlocked.</p> <p>or</p> <p>The SmartKey battery is discharged.</p> <ul style="list-style-type: none"> ► Unlock the vehicle (▷ page 74). <p>or</p> <ul style="list-style-type: none"> ► Unlock the vehicle using the mechanical key (▷ page 75).
	<p>The fuel filler flap is unlocked, but the opening mechanism is jammed.</p> <ul style="list-style-type: none"> ► Consult a qualified specialist workshop.

Parking

Important safety notes

WARNING

Flammable material such as leaves, grass or twigs may ignite if they come into contact with hot parts of the exhaust system or exhaust gas flow. There is a risk of fire.

Park the vehicle so that no flammable materials come into contact with parts of the vehicle which are hot. Take particular care not to park on dry grassland or harvested grain fields.

WARNING

If you leave children unsupervised in the vehicle, they could set it in motion by, for example:

- releasing the parking brake
- shifting the automatic transmission out of the parking position **P**
- starting the engine.

They could also operate the vehicle's equipment. There is a risk of an accident and injury.

When leaving the vehicle, always take the SmartKey with you and lock the vehicle. Never leave children unsupervised in the vehicle.

-  Always secure the vehicle correctly against rolling away. Otherwise, the vehicle or its drivetrain could be damaged.

To ensure that the vehicle is secured against rolling away unintentionally:

- the electric parking brake must be applied.
- the transmission must be in position **P** and the transmission position display must show **P**.
- the SmartKey must be removed from the ignition lock.
- on uphill or downhill gradients, the front wheels must be turned towards the curb.

Switching off the engine

Important safety notes

WARNING

The automatic transmission switches to neutral position **N** when you switch off the engine. The vehicle may roll away. There is a risk of an accident.

After switching off the engine, always switch to parking position **P**. Prevent the parked vehicle from rolling away by applying the parking brake.

Vehicles with automatic transmission

- ▶ Apply the electric parking brake.
 - ▶ Shift the transmission to position **P**.
 - ▶ Turn the SmartKey to position **0** in the ignition lock and remove it. The immobilizer is activated.
- i** If you switch the engine off with the transmission in position **R** or **D**, the automatic transmission shifts to **N** automatically.
- If you then open one of the front doors or remove the SmartKey from the ignition, the automatic transmission shifts to **P**.
- If you shift the automatic transmission to **N** before switching off the engine, the automatic transmission remains in **N** even if a door is opened.

i The automatic transmission shifts to **P** automatically if you:

- switch off the engine using the SmartKey and remove the SmartKey from the ignition lock or
- switch off the engine using the SmartKey and open a front door.

If you attempt to turn off the engine when the selector lever is not in position **P**:

- a message appears in the multifunction display
- a warning signal sounds

Electric parking brake

General notes

WARNING

If you leave children unsupervised in the vehicle, they could set it in motion by, for example:

- releasing the parking brake
- shifting the automatic transmission out of the parking position **P**
- starting the engine.

They could also operate the vehicle's equipment. There is a risk of an accident and injury.

When leaving the vehicle, always take the SmartKey with you and lock the vehicle. Never leave children unsupervised in the vehicle.



i The electric parking brake performs a function test at regular intervals while the

engine is switched off. The sounds that can be heard while this is occurring are normal.

Applying/releasing manually

Applying

- ▶ Push handle ①.

When the electric parking brake is engaged, the  red indicator lamp lights up in the instrument cluster.

- i** The electric parking brake can also be applied when the SmartKey is removed.

Releasing

- ▶ Pull handle ①.

The red  indicator lamp in the instrument cluster goes out.

- i** You can only release the electric parking brake when the SmartKey is in position **1** or **2** in the ignition lock.

Applying automatically

The electric parking brake is applied automatically:

- if DISTRONIC PLUS brings the vehicle to a standstill or
- if the HOLD function is keeping the vehicle stationary

In addition, at least one of the following conditions must be fulfilled:

- the engine is switched off.
- the driver's door is open and the seat belt is not fastened.
- there is a system malfunction.
- the power supply is insufficient.
- the vehicle is stationary for a lengthy period.

The red  indicator lamp in the instrument cluster lights up.

- i** The electric parking brake is not automatically engaged if the engine is switched off by the ECO start/stop function.

Releasing automatically

Your vehicle's electric parking brake is automatically released if all of the following conditions are met:

- the engine is running.
- the transmission is in position **D** or **R**.
- the seat belt has been fastened.
- you depress the accelerator pedal.

If the transmission is in position **R**, the tailgate must be closed.

If your seat belt is not fastened, the following conditions must be fulfilled to automatically release the electric parking brake:

- the driver's door is closed.
- you have shifted out of transmission position **P** or you have previously driven faster than 2 mph (3 km/h).

Emergency braking

The vehicle can also be braked during an emergency by using the electric parking brake.

- ▶ While driving, push handle ① of the electric parking brake (▷ page 153).

- i** The vehicle is braked for as long as handle ① of the electric parking brake is pressed. The longer electric parking brake handle ① is depressed, the greater the braking force.

During braking:

- a warning tone sounds
- the **Release Park. Brake** message appears
- the red  indicator lamp in the instrument cluster flashes

When the vehicle has been braked to a standstill, the electric parking brake is engaged.

Parking the vehicle for a long period

If you leave the vehicle parked for longer than four weeks, the battery may be damaged by exhaustive discharging.

If you leave the vehicle parked for longer than six weeks, the vehicle may suffer damage as a result of lack of use.

- ▶ Visit a qualified specialist workshop and seek advice.

i You can obtain information about trickle chargers from a qualified specialist workshop.

Driving tips

General notes

Important safety notes

WARNING

If you switch off the ignition while driving, safety-relevant functions are only available with limitations, or not at all. This could affect, for example, the power steering and the brake boosting effect. You will require considerably more effort to steer and brake. There is a risk of an accident.

Do not switch off the ignition while driving.

WARNING

If you operate mobile communication equipment while driving, you will be distracted from traffic conditions. You could also lose control of the vehicle. There is a risk of an accident.

Only operate this equipment when the vehicle is stationary.

Observe the legal requirements for the country in which you are driving. Some jurisdictions prohibit the driver from using a mobile phone while driving a vehicle.

If you make a call while driving, always use hands-free mode. Only operate the telephone when the traffic situation permits. If you are

unsure, pull over to a safe location and stop before operating the telephone.

Bear in mind that at a speed of only 30 mph (approximately 50 km/h), the vehicle covers a distance of 44 ft (approximately 14 m) per second.

Drive sensibly – save fuel

Observe the following tips to save fuel:

- The tires should always be inflated to the recommended tire pressure.
- Remove unnecessary loads.
- Remove roof racks when they are not needed.
- Warm up the engine at low engine speeds.
- Avoid frequent acceleration or braking.
- Have all maintenance work carried out as indicated by the service intervals in the Maintenance Booklet or by the service interval display.

Fuel consumption also increases when driving in cold weather, in stop-start traffic and in hilly terrain.

Drinking and driving

WARNING

Drinking and driving and/or taking drugs and driving are very dangerous combinations. Even a small amount of alcohol or drugs can affect your reflexes, perceptions and judgment.

The possibility of a serious or even fatal accident is greatly increased when you drink or take drugs and drive.

Do not drink or take drugs and drive or allow anyone to drive who has been drinking or taking drugs.

Emission control

WARNING

Combustion engines emit poisonous exhaust gases such as carbon monoxide. Inhaling these exhaust gases leads to poisoning. There

is a risk of fatal injury. Therefore never leave the engine running in enclosed spaces without sufficient ventilation.

Certain engine systems are designed to keep the level of poisonous components in exhaust fumes within legal limits.

These systems only work at peak efficiency if they are serviced exactly in accordance with the manufacturer's specifications. For this reason, only have work on the engine carried out by qualified and authorized Mercedes-Benz technicians.

The engine settings must not be changed under any circumstances. Furthermore, all specific service work must be carried out at regular intervals and in accordance with the Mercedes-Benz service requirements. Details can be found in the Maintenance Booklet.

ECO display

The ECO display gives you information on how economical your driving style is. The ECO display assists you in achieving the optimum driving style in terms of consumption, taking the actual and selected conditions into consideration. Your driving style can significantly influence the vehicle's consumption.

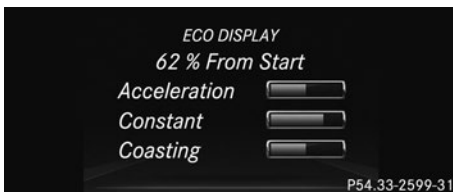

Example: ECO display (color multifunction display)

The ECO display consists of three bars:

- **Acceleration**
- **Constant**
- **Coasting**

The percent value is the average value of the three bars. The three bars and the mean value begin at the value of 50%. A higher

percentage indicates a more economical driving style.

The ECO display does not indicate the actual fuel consumption and a fixed percentage count in the ECO display does not indicate a fixed consumption figure.

Apart from driving style, consumption is dependent on many factors such as, e.g.:

- load
- tire pressure
- cold start
- choice of route
- electrical consumers switched on

These factors are not taken into consideration by the ECO display.

The evaluation of your driving style is carried out using the following three categories:

- **Acceleration** (evaluation of all acceleration processes):
 - The bar fills up: moderate acceleration, especially at higher speeds
 - The bar empties: sporty acceleration
- **Constant** (assessment of driving behavior at all times):
 - The bar fills up: constant speed and avoidance of unnecessary acceleration and deceleration
 - The bar empties: fluctuations in speed
- **Coasting** (assessment of all deceleration processes):
 - The bar fills up: anticipatory driving, keeping your distance and early release of the accelerator. The vehicle can coast without use of the brakes.
 - The bar empties: frequent braking

i An economical driving style specially requires driving at moderate engine speeds.

To achieve a higher value in the categories **Acceleration** and **Constant**:

- observe the gearshift recommendations.
- drive in drive program **E**.

- i** On long journeys at a constant speed, e.g. on the highway, only the bar for **Constant** will change.
- i** The ECO display summarizes the driving characteristics from the start of the journey to its completion. For this reason, the bars change dynamically at the beginning of the journey. On longer journeys, there are fewer changes. For more dynamic changes, carry out a manual reset.

Further information on the ECO display
(▶ page 194).

Braking

Important safety notes

WARNING

If you shift down on a slippery road surface in an attempt to increase the engine's braking effect, the drive wheels could lose their grip. There is an increased danger of skidding and accidents.

Do not shift down for additional engine braking on a slippery road surface.

Downhill gradients

- !** On long and steep gradients, you must reduce the load on the brakes by shifting to a lower gear in good time. This allows you to take advantage of the engine's braking effect. For this, you need to have selected manual drive program **M**. This helps you to avoid overheating the brakes and wearing them out excessively.

When you take advantage of the engine's braking effect, a drive wheel may not turn for some time, e.g. on a slippery road surface. This could cause damage to the drive train. This type of damage is not covered by the Mercedes-Benz warranty.

- i** Briefly depressing the accelerator pedal on downhill gradients while the manual drive program **M** is temporarily activated: the automatic transmission may switch to

the last active automatic drive program **E** or **S**. The automatic transmission may shift to a higher gear. This can reduce the engine's braking effect.

Heavy and light loads

WARNING

If you rest your foot on the brake pedal while driving, the braking system can overheat. This increases the stopping distance and can even cause the braking system to fail. There is a risk of an accident.

Never use the brake pedal as a footrest. Never depress the brake pedal and the accelerator pedal at the same time.

- !** Depressing the brake pedal constantly results in excessive and premature wear to the brake pads.

If the brakes have been subjected to a heavy load, do not stop the vehicle immediately. Drive on for a short while. This allows the airflow to cool the brakes more quickly.

Wet roads

If you have driven for a long time in heavy rain without braking, there may be a delayed reaction from the brakes when braking for the first time. This may also occur after the vehicle has been washed or driven through deep water.

You have to depress the brake pedal more firmly. Maintain a greater distance from the vehicle in front.

After driving on a wet road or having the vehicle washed, brake firmly while paying attention to the traffic conditions. This will warm up the brake discs, thereby drying them more quickly and protecting them against corrosion.

Limited braking performance on salt-treated roads

If you drive on salted roads, a layer of salt residue may form on the brake discs and

brake pads. This can result in a significantly longer braking distance.

- Brake occasionally to remove any possible salt residue. Make sure that you do not endanger other road users when doing so.
- Carefully depress the brake pedal at the beginning and end of a journey.
- Maintain a greater distance to the vehicle ahead.

Servicing the brakes

! If the red brake warning lamp lights up in the instrument cluster and you hear a warning tone while the engine is running, the brake fluid level may be too low. Observe additional warning messages in the multifunction display.

The brake fluid level may be too low due to brake pad wear or leaking brake lines.

Have the brake system checked immediately. This work should be carried out at a qualified specialist workshop.

! A function or performance test should only be carried out on a 2-axle dynamometer. If you are planning to have the vehicle tested on such a dynamometer, contact an authorized Mercedes-Benz Center to obtain further information first. Otherwise, you could damage the drive train or the brake system.

! As the ESP[®] system operates automatically, the engine and the ignition must be switched off (the SmartKey must be in position **0** or **1** in the ignition lock) if:

- the electric parking brake is tested on a brake dynamometer (for a maximum of ten seconds)
- the vehicle is towed with the front axle raised.

Braking triggered automatically by ESP[®] may seriously damage the brake system.

All checks and maintenance work on the brake system must be carried out at a

qualified specialist workshop. Consult a qualified specialist workshop to arrange this.

Have brake pads installed and brake fluid replaced at a qualified specialist workshop.

If the brake system has only been subject to moderate loads, you should test the functionality of your brakes at regular intervals.

You can find a description of Brake Assist (BAS) on [▷ page 64](#).

Mercedes-Benz recommends that you only have brake pads/linings installed on your vehicle which have been approved for Mercedes-Benz vehicles or which correspond to an equivalent quality standard. Brake pads/linings which have not been approved for Mercedes-Benz vehicles or which are not of an equivalent quality could affect your vehicle's operating safety.

Mercedes-Benz recommends that you only use brake fluid that has been specially approved for your vehicle by Mercedes-Benz, or which corresponds to an equivalent quality standard. Brake fluid which has not been approved for Mercedes-Benz vehicles or which is not of an equivalent quality could affect your vehicle's operating safety.

Checking brake lining thickness

You can measure the brake pad/lining thickness using a test gauge. Color-coding (green or red) on the test gauge allows you to determine whether the brake pad/lining thickness is still sufficient. The test gauge is in the vehicle document wallet in the glove box.



Front wheel

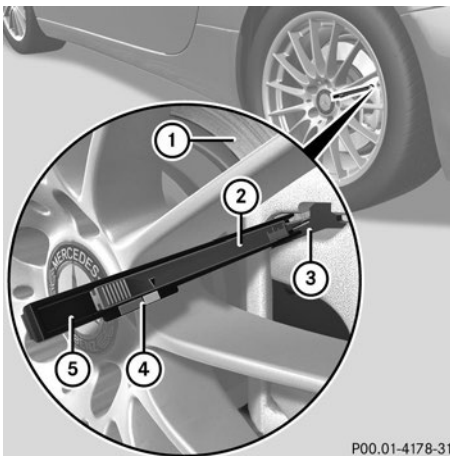

Rear wheel

- ▶ Bring the vehicle and wheels into a suitable position so that you can attach test gauge ⑤.
- ▶ Secure the vehicle against rolling away (> page 152).
- ▶ Move the selector lever to position **P**.
- ▶ Switch off the engine.
- ▶ Place test gauge ⑤ between the wheel's spokes on brake pad/lining ③.

- ▶ Hold test gauge ⑤ vertically on brake disc ① and slide measuring pin ② onto brake disc ①.
- ▶ Check which color field ④ the arrow on measuring pin ② is pointing to.
 - Green:** the brake pad/lining thickness is sufficient.
 - Red:** the brake pad/lining thickness is not sufficient. Have the brake pads/lining checked at a qualified specialist workshop.

- i** To avoid an inaccurate measurement:
 - make sure you position the wheels suitably
 - do not put the measuring pin on a recess in the brake disc

Driving on wet roads

Hydroplaning

If water has accumulated to a certain depth on the road surface, there is a danger of hydroplaning occurring, even if:

- you drive at low speeds.
- the tires have adequate tread depth.

For this reason, in the event of heavy rain or in conditions in which hydroplaning may occur, you must drive in the following manner:

- lower your speed.
- avoid ruts.
- brake carefully.

Driving on flooded roads

- !** Do not drive through flooded areas. Check the depth of any water before driving through it. Drive slowly through standing water. Otherwise, water may enter the vehicle interior or the engine compartment. This can damage the electronic components in the engine or the automatic transmission. Water can also be drawn in by the engine's air suction nozzles and this can cause engine damage.

Winter driving

General notes

WARNING

If you shift down on a slippery road surface in an attempt to increase the engine's braking effect, the drive wheels could lose their grip. There is an increased danger of skidding and accidents.

Do not shift down for additional engine braking on a slippery road surface.

DANGER

If the exhaust pipe is blocked or adequate ventilation is not possible, poisonous gases such as carbon monoxide (CO) may enter the vehicle. This is the case, e.g. if the vehicle becomes trapped in snow. There is a risk of fatal injury.

If you leave the engine or the auxiliary heating running, make sure the exhaust pipe and area around the vehicle are clear of snow. To ensure an adequate supply of fresh air, open a window on the side of the vehicle that is not facing into the wind.

Have your vehicle winterproofed at a qualified specialist workshop at the onset of winter.

Observe the notes in the "Winter operation" section (▷ page 314).

Driving with summer tires

Observe the notes in the "Winter operation" section (▷ page 314).

Slippery road surfaces

WARNING

If you shift down on a slippery road surface in an attempt to increase the engine's braking effect, the drive wheels could lose their grip. There is an increased danger of skidding and accidents.

Do not shift down for additional engine braking on a slippery road surface.

If the vehicle threatens to skid or cannot be stopped when moving at low speed:

- ▶ Shift the transmission to position **N**.

Drive particularly carefully on slippery road surfaces. Avoid sudden acceleration, steering and braking maneuvers. Do not use the cruise control or DISTRONIC PLUS.

The outside temperature indicator is not designed to serve as an ice-warning device and is therefore unsuitable for that purpose. Changes in the outside temperature are displayed after a short delay.

Indicated temperatures just above the freezing point do not guarantee that the road surface is free of ice. The road may still be icy, especially in wooded areas or on bridges. You should pay special attention to road conditions when temperatures are around freezing point.

-  For more information on driving with snow chains, see (▷ page 315).

Driving systems

Cruise control

General notes

Cruise control maintains a constant road speed for you. It brakes automatically in order to avoid exceeding the set speed. On long and steep downhill gradients, especially if the vehicle is laden, you must select a low gear in good time. For this, you will need to have selected manual drive program **M** (▷ page 147). By doing so, you will make use of the braking effect of the engine. This relieves the load on the brake system and prevents the brakes from overheating and wearing too quickly.

Use cruise control only if road and traffic conditions make it appropriate to maintain a steady speed for a prolonged period. You can store any road speed above 20 mph (30 km/h).

Important safety notes

If you fail to adapt your driving style, cruise control can neither reduce the risk of an accident nor override the laws of physics. Cruise control cannot take into account the road, traffic and weather conditions. Cruise control is only an aid. You are responsible for the distance to the vehicle in front, for vehicle speed, for braking in good time and for staying in your lane.

Do not use cruise control:

- in road and traffic conditions which do not allow you to maintain a constant speed e.g. in heavy traffic or on winding roads
- on slippery road surfaces. Braking or accelerating could cause the drive wheels to lose traction and the vehicle could then skid
- when there is poor visibility, e.g. due to fog, heavy rain or snow

If there is a change of drivers, advise the new driver of the speed stored.

Cruise control lever

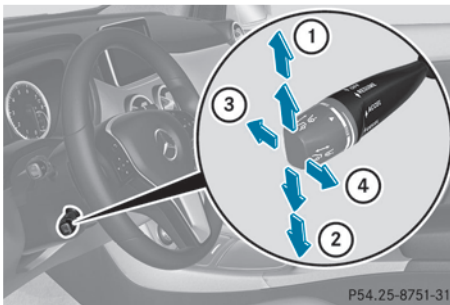

- ① To activate or increase speed
- ② To activate or reduce speed
- ③ To deactivate cruise control
- ④ To activate at the current speed/last stored speed

When you activate cruise control, the stored speed is shown in the multifunction display for five seconds.

Activation conditions

To activate cruise control, all of the following activation conditions must be fulfilled:

- the electric parking brake must be released.
- you are driving faster than 20 mph(30 km/h).
- ESP® must be active, but not intervening.
- on vehicles with automatic transmission, the selector lever must be in position D.

Storing, maintaining and calling up a speed

Storing and maintaining the current speed

You can store the current speed if you are driving faster than 20 mph (30km/h).

- ▶ Accelerate the vehicle to the desired speed.
- ▶ Briefly press the cruise control lever up ① or down ②.
- ▶ Remove your foot from the accelerator pedal. Cruise control is activated. The vehicle automatically maintains the stored speed.

- ❗ Cruise control may be unable to maintain the stored speed on uphill gradients. The stored speed is resumed when the gradient evens out. Cruise control maintains the stored speed on downhill gradients by automatically applying the brakes.

Storing the current speed or calling up the last stored speed

⚠ WARNING

If you call up the stored speed and it differs from the current speed, the vehicle accelerates or decelerates. If you do not know the stored speed, the vehicle could accelerate or brake unexpectedly. There is a risk of an accident.

Pay attention to the road and traffic conditions before calling up the stored speed.

If you do not know the stored speed, store the desired speed again.

- ▶ Briefly pull the cruise control lever towards you ④.
- ▶ Remove your foot from the accelerator pedal.
The first time cruise control is activated, it stores the current speed or regulates the speed of the vehicle to the previously stored speed.

Setting a speed

Keep in mind that it may take a brief moment until the vehicle has accelerated or braked to the speed set.

- ▶ Press the cruise control lever up ① for a higher speed or down ② for a lower speed.
 - ▶ **To adjust the set speed in 1 mph increments (1 km/h increments):** briefly press the cruise control lever up ① or down ② to the pressure point.
Every time the cruise control lever is pressed up ① or down ② the last speed stored is increased or reduced.
 - ▶ **To adjust the set speed in 5 mph increments (10 km/h increments):** briefly press the cruise control lever up ① or down ② to the pressure point.
Every time the cruise control lever is pressed up ① or down ② the last speed stored is increased or reduced.
- i** Cruise control is not deactivated if you depress the accelerator pedal. For example, if you accelerate briefly to overtake, cruise control adjusts the vehicle's speed to the last speed stored after you have finished overtaking.

Deactivating cruise control

There are several ways to deactivate cruise control:

- ▶ Briefly press the cruise control lever forwards ③.
- or
- ▶ Brake.

Cruise control is automatically deactivated if:

- the vehicle is secured with the electric parking brake
- you are driving at less than 20 mph (30 km/h)
- ESP® intervenes or you deactivate ESP®
- you shift the transmission to position **N** while driving

If cruise control is deactivated, you will hear a warning tone. You will see the **Cruise Control Off** message in the multifunction display for approximately five seconds.

- i** When you switch off the engine, the last speed stored is cleared.

DISTRONIC PLUS

General notes

DISTRONIC PLUS regulates the speed and automatically helps you maintain the distance to the vehicle detected in front. Vehicles are detected with the aid of the radar sensor system. DISTRONIC PLUS brakes automatically so that the set speed is not exceeded.

Change into a lower gear in good time on long and steep downhill gradients. This is especially important if the vehicle is laden. By doing so, you will make use of the braking effect of the engine. This relieves the load on the brake system and prevents the brakes from overheating and wearing too quickly.

If DISTRONIC PLUS detects that there is a risk of a collision, you will be warned visually and acoustically. DISTRONIC PLUS cannot prevent a collision without your intervention.

An intermittent warning tone will then sound and the distance warning lamp will light up in the instrument cluster. Brake immediately in order to increase the distance to the vehicle in front or take evasive action provided it is safe to do so.

For DISTRONIC PLUS to assist you, the radar sensor system must be operational.

DISTRONIC PLUS is automatically deactivated if:

- you are driving slower than 15 mph (25 km/h) and there is no longer a vehicle in front or
- the vehicle in front is no longer detected

If there is no vehicle in front, DISTRONIC PLUS operates in the same way as cruise control in the speed range between 20 mph (30 km/h) and 120 mph (200 km/h). If a vehicle is driving in front of you, it operates in the speed range between 0 mph (0 km/h) and 120 mph (200 km/h).

Do not use DISTRONIC PLUS while driving on roads with steep gradients.

As DISTRONIC PLUS transmits radar waves, it can resemble the radar detectors of the responsible authorities. You can refer to the relevant chapter in the Operator's Manual if questions are asked about this.

- i** This device complies with RSS-210 of Industry Canada. Operation is subject to the following two conditions:
1. This device may not cause harmful interference, and
 2. this device must accept any interference received, including interference that may cause undesired operation of the device.
- Removal, tampering, or altering of the device will void any warranties, and is not permitted. Do not tamper with, alter, or use in any non-approved way.
- Any unauthorized modification to this device could void the user's authority to operate the equipment.

Important safety notes

WARNING

DISTRONIC PLUS does not react to:

- people or animals
- stationary obstacles on the road, e.g. stopped or parked vehicles
- oncoming and crossing traffic

As a result, DISTRONIC PLUS may neither give warnings nor intervene in such situations.

There is a risk of an accident.

Always pay careful attention to the traffic situation and be ready to brake.

WARNING

DISTRONIC PLUS cannot always clearly identify other road users and complex traffic situations.

In such cases, DISTRONIC PLUS may:

- give an unnecessary warning and then brake the vehicle
- neither give a warning nor intervene
- accelerate unexpectedly

There is a risk of an accident.

Continue to drive carefully and be ready to brake, in particular when warned to do so by DISTRONIC PLUS.

WARNING

DISTRONIC PLUS brakes your vehicle with up to 40% of the maximum braking force. If this braking force is insufficient, DISTRONIC PLUS warns you visually and audibly. There is a risk of an accident.

In such cases, apply the brakes yourself and try to take evasive action.

! If DISTRONIC PLUS or the HOLD function is activated, the vehicle brakes automatically in certain situations. To prevent damage to the vehicle, deactivate DISTRONIC PLUS and the HOLD function in the following or other similar situations:

- when towing the vehicle
- in the car wash

If you fail to adapt your driving style, DISTRONIC PLUS can neither reduce the risk of accident nor override the laws of physics. DISTRONIC PLUS cannot take into account the road, traffic and weather conditions. DISTRONIC PLUS is only an aid. You are responsible for the distance to the vehicle in front, for vehicle speed, for braking in good time and for staying in your lane.

Do not use DISTRONIC PLUS:

- in road and traffic conditions which do not allow you to maintain a constant speed e.g. in heavy traffic or on winding roads
- on slippery road surfaces. Braking or accelerating could cause the drive wheels to lose traction and the vehicle could then skid
- when there is poor visibility, e.g. due to fog, heavy rain or snow

DISTRONIC PLUS may not detect narrow vehicles driving in front, e.g. motorcycles, or vehicles driving on a different line.

In particular, the detection of obstacles can be impaired if:

- dirt on the sensors or anything else covering the sensors
- snow or heavy rain
- interference by other radar sources
- strong radar reflections, for example, in parking garages

If DISTRONIC PLUS no longer detects a vehicle in front, DISTRONIC PLUS may unexpectedly accelerate the vehicle to the stored speed.

This speed may:

- be too high if you are driving in a filter lane or an exit lane
- be so high when driving in the right-hand lane that you overtake vehicles in the left-hand lane
- be so high when driving in the left-hand lane that you overtake vehicles in the right-hand lane

If there is a change of drivers, advise the new driver of the speed stored.

Cruise control lever

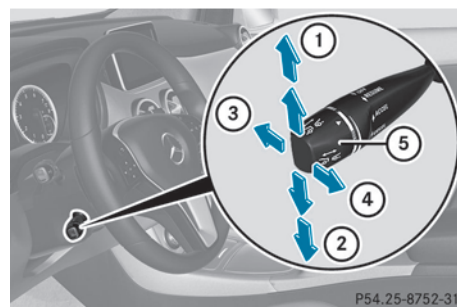

- ① To store the current speed or a higher speed
- ② To store the current speed or a lower speed
- ③ To deactivate DISTRONIC PLUS
- ④ To store the current speed or calling up the last stored speed
- ⑤ To set the specified minimum distance

Activating DISTRONIC PLUS

Activation conditions

To activate DISTRONIC PLUS, all of the following activation conditions must be fulfilled:

- the engine must be started. It may take up to two minutes after pulling away before DISTRONIC PLUS is operational.
- the electric parking brake must be released.
- ESP[®] must be active, but not intervening.

- Active Parking Assist must not be activated.
- the transmission must be in position **D**.
- the driver's door must be closed when you shift from **P** to **D** or your seat belt must be fastened.
- the front-passenger door and rear doors must be closed.

Activating

To activate whilst driving: you can only activate DISTRONIC PLUS at speeds below 14 mph (20 km/h), if the vehicle in front is detected and shown in the multifunction display. If the vehicle in front is no longer detected and displayed, DISTRONIC PLUS switches off and a tone sounds.

- ▶ Briefly pull the cruise control lever towards you ④ or press it up ① or down ②. DISTRONIC PLUS is selected.
- ▶ Press the cruise control lever repeatedly up ① or down ② until the desired speed is set.
- ▶ Remove your foot from the accelerator pedal.
Your vehicle adapts its speed to that of the vehicle in front, but only up to the desired stored speed.

i If you do not fully release the accelerator pedal, the **DISTRONIC PLUS Passive** message appears in the multifunction display. The set distance to a slower-moving vehicle in front will then not be maintained. You will be driving at the speed you determine by the position of the accelerator pedal.

Activating at the current speed/last stored speed

WARNING

If you call up the stored speed and it differs from the current speed, the vehicle accelerates or decelerates. If you do not know the stored speed, the vehicle could accelerate

or brake unexpectedly. There is a risk of an accident.

Pay attention to the road and traffic conditions before calling up the stored speed. If you do not know the stored speed, store the desired speed again.

- ▶ Briefly pull the cruise control lever (▷ page 164) towards you ④.
- ▶ Remove your foot from the accelerator pedal.
DISTRONIC PLUS is activated. The first time it is activated, the current speed is stored. Otherwise, it sets the vehicle cruise speed to the previously stored value.

Driving with DISTRONIC PLUS

Pulling away and driving

i The vehicle can also pull away when it is facing an unidentified obstacle or is driving on a different line from another vehicle. The vehicle then brakes automatically. There is a risk of an accident. Be ready to brake at all times.

If you depress the brake, DISTRONIC PLUS is deactivated unless your vehicle is stationary.

▶ **If you want to pull away with DISTRONIC PLUS:** remove your foot from the brake pedal.

- ▶ Briefly pull the cruise control lever (▷ page 164) towards you ④.

or

- ▶ Accelerate briefly.
Your vehicle pulls away and adapts its speed to that of the vehicle in front.
If no vehicle is detected in front, your vehicle accelerates to the set speed.

If there is no vehicle in front, DISTRONIC PLUS operates in the same way as cruise control.

If DISTRONIC PLUS detects that the vehicle in front has slowed down, it brakes your vehicle. In this way, the distance you have selected is maintained.

If DISTRONIC PLUS detects a faster-moving vehicle in front, it increases the driving speed. The vehicle is only accelerated up to the speed you have stored.

Changing lanes

If you change to the passing lane, DISTRONIC PLUS supports you when:

- you are driving faster than 40 mph (60 km/h)
- DISTRONIC PLUS is maintaining the distance to a vehicle in front
- you switch on the appropriate turn signal
- DISTRONIC PLUS does not detect a danger of collision

If these conditions are fulfilled, your vehicle is accelerated. Acceleration will be interrupted if changing lanes takes too long or if the distance between your vehicle and the vehicle in front becomes too small.

- i When changing lanes, DISTRONIC PLUS monitors the left lane on left-hand drive vehicles and the right lane on right-hand drive vehicles.

Stopping

WARNING

When leaving the vehicle, even if it is braked only by DISTRONIC PLUS, it could roll away if:

- there is a malfunction in the system or in the voltage supply.
- DISTRONIC PLUS has been deactivated with the cruise control lever, e.g. by a vehicle occupant or from outside the vehicle.
- the electrical system in the engine compartment, the battery or the fuses have been tampered with.
- the battery is disconnected.
- the accelerator pedal has been depressed, e.g. by a vehicle occupant.

There is a risk of an accident.

If you wish to exit the vehicle, always turn off DISTRONIC PLUS and secure the vehicle against rolling away.

For further information on deactivating DISTRONIC PLUS (▷ page 167).

If DISTRONIC PLUS detects that the vehicle in front is stopping, it brakes your vehicle until it is stationary.

Once your vehicle is stationary, it remains stationary and you do not need to depress the brake.

- i After a time, the electric parking brake secures the vehicle and relieves the service brake.

- i Depending on the specified minimum distance, your vehicle will come to a standstill at a sufficient distance behind the vehicle in front. The specified minimum distance is set using the control on the cruise control lever.

The electric parking brake automatically secures the vehicle if DISTRONIC PLUS is activated and:

- the seat belt is unfastened and the driver's door is open.
- the engine is switched off, unless it is automatically switched off by the ECO start/stop function.
- a system malfunction occurs.
- the power supply is not sufficient.

If a malfunction occurs, then the transmission may be shifted into position **P** automatically.

Setting a speed

Keep in mind that it may take a brief moment until the vehicle has accelerated or braked to the speed set.

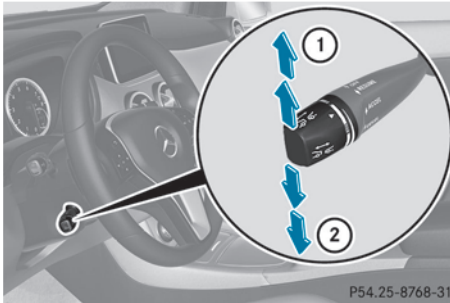

- ① To store the current speed or a higher speed
 - ② To store the current speed or a lower speed
- ▶ Press the cruise control lever up ① for a higher speed or down ② for a lower speed.

▶ **To adjust the set speed in 1 mph increments (1 km/h increments):** briefly press the cruise control lever up ① or down ② to the pressure point. Every time the cruise control lever is pressed up ① or down ② the last speed stored is increased or reduced.

▶ **To adjust the set speed in 5 mph increments (10 km/h increments):** briefly press the cruise control lever up ① or down ② to the pressure point. Every time the cruise control lever is pressed up ① or down ②, the last speed stored is increased or reduced.

- ❗ **DISTRONIC PLUS** is not deactivated if you depress the accelerator pedal. If you accelerate to overtake, **DISTRONIC PLUS** adjusts the vehicle's speed to the last speed stored after you have finished overtaking.

Setting the specified minimum distance

You can set the specified minimum distance for **DISTRONIC PLUS** by varying the time span between one and two seconds. With this function, you can set the minimum distance that **DISTRONIC PLUS** keeps to the vehicle in front, dependent on vehicle speed. You can

see this distance in the multifunction display (▶ page 168).

- ❗ Make sure that you maintain the minimum distance to the vehicle in front as required by law. Adjust the distance to the vehicle in front if necessary.

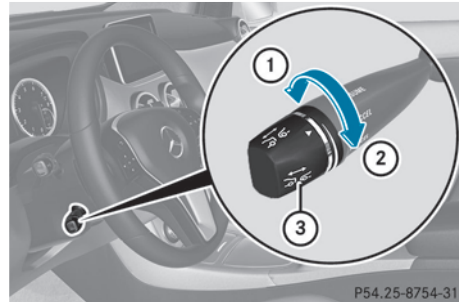

- ▶ **To increase:** turn control ③ in direction ②. **DISTRONIC PLUS** then maintains a greater distance between your vehicle and the vehicle in front.
- ▶ **To decrease:** turn control ③ in direction ①. **DISTRONIC PLUS** then maintains a shorter distance between your vehicle and the vehicle in front.

Deactivating **DISTRONIC PLUS**

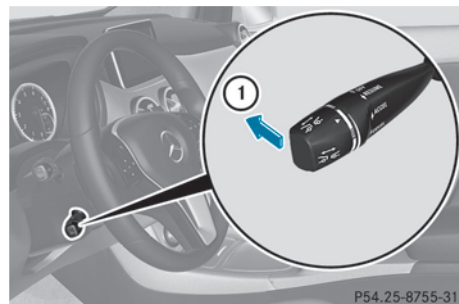

There are several ways to deactivate DISTRONIC PLUS:

- ▶ Briefly press the cruise control lever forwards ①.

or

- ▶ Brake, unless the vehicle is stationary.

When you deactivate DISTRONIC PLUS, you will see the **DISTRONIC PLUS Off** message in the multifunction display for approximately five seconds.

- ❗ The last speed stored remains stored until you switch off the engine. DISTRONIC PLUS is not deactivated if you depress the accelerator pedal.

DISTRONIC PLUS is automatically deactivated if:

- you engage the electric parking brake or if the vehicle is automatically secured with the electric parking brake
- you are driving slower than 7 mph (10 km/h) and there is no vehicle in front, or if the vehicle in front is no longer detected
- ESP® intervenes or you deactivate ESP®
- the transmission is in the **P**, **R** or **N** position
- you pull the cruise control lever towards you in order to pull away and the front-passenger door or one of the rear doors is open
- the vehicle is skidding
- you activate Active Parking Assist

If DISTRONIC PLUS is deactivated, you will hear a warning tone. You will see the **DISTRONIC PLUS Off** message in the multifunction display for approximately five seconds.

DISTRONIC PLUS displays in the instrument cluster

Displays in the speedometer



Example: DISTRONIC PLUS displays in the speedometer

When DISTRONIC PLUS is activated, one or two segments ② in the set speed range light up.

If DISTRONIC PLUS detects a vehicle in front, segments ② between speed of the vehicle in front ③ and stored speed ① light up.

- ❗ For design reasons, the speed displayed in the speedometer may differ slightly from the speed set for DISTRONIC PLUS.

Display when DISTRONIC PLUS is deactivated

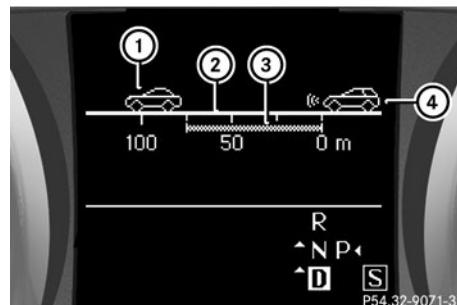

Distance display in vehicles with a black and white multifunction display

- ① Vehicle in front, if detected
- ② Distance indicator, current distance to the vehicle in front

- ③ Specified minimum distance to the vehicle in front; adjustable
- ④ Own vehicle

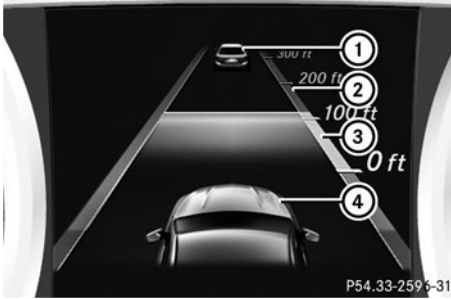

Assistance graphic in vehicles with a color multifunction display

- ① Vehicle in front, if detected
- ② Distance indicator, current distance to the vehicle in front
- ③ Specified minimum distance to the vehicle in front; adjustable
- ④ Own vehicle

On vehicles with a black and white multifunction display: in the Assistance menu (▷ page 199) of the on-board computer, you can select the distance display.

Vehicles with a color multifunction display: in the Assistance menu (▷ page 199) of the on-board computer, you can select the assistance graphic.

- ▶ **Vehicles with black and white multifunction display:** select the **Distance Display** function using the on-board computer (▷ page 199).
- ▶ **Vehicles with color multifunction display:** select the **Assistance Graphic** function using the on-board computer (▷ page 199).

Display when DISTRONIC PLUS is activated

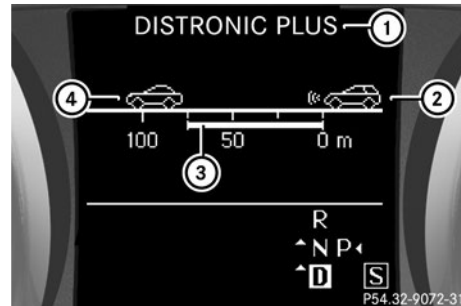

Distance display in vehicles with a black and white multifunction display

- ① DISTRONIC PLUS activated
- ② Own vehicle
- ③ Specified minimum distance to the vehicle in front; adjustable
- ④ Vehicle in front, if detected



Assistance graphic in vehicles with a color multifunction display

- ① Vehicle in front, if detected
- ② Specified minimum distance to the vehicle in front; adjustable
- ③ Own vehicle
- ④ DISTRONIC PLUS active (text only appears when the cruise control lever is actuated)

▶ **Vehicles with black and white multifunction display:** select the **Distance Display** function using the on-board computer (▷ page 199).

▶ **Vehicles with color multifunction display:** select the **Assistance Graphic**

function using the on-board computer (> page 199).

You will initially see the stored speed for about five seconds when you activate DISTRONIC PLUS.

Tips for driving with DISTRONIC PLUS

General notes

The following contains descriptions of certain road and traffic conditions in which you must be particularly attentive. In such situations, brake if necessary. DISTRONIC PLUS is then deactivated.

Cornering, going into and coming out of a bend

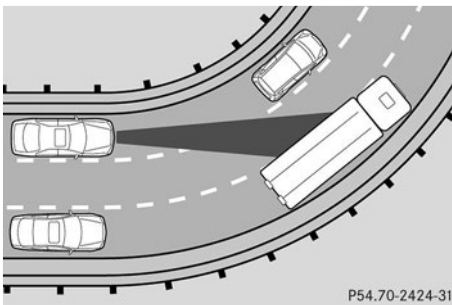

The ability of DISTRONIC PLUS to detect vehicles when cornering is limited. Your vehicle may brake unexpectedly or late.

Vehicles traveling on a different line

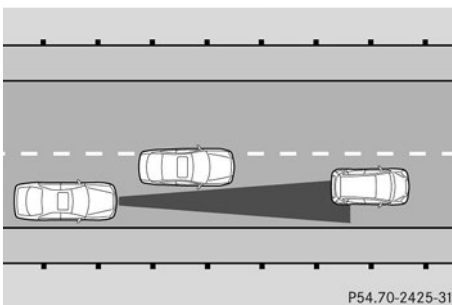

DISTRONIC PLUS may not detect vehicles traveling on a different line. The distance to the vehicle in front will be too short.

Other vehicles changing lanes

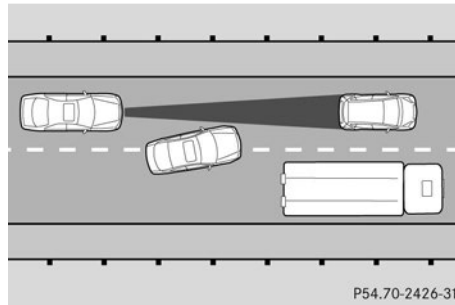

DISTRONIC PLUS has not detected the vehicle cutting in yet. The distance to this vehicle will be too short.

Narrow vehicles

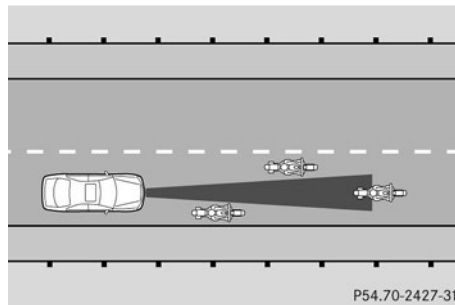

DISTRONIC PLUS has not yet detected the vehicle in front on the edge of the road, because of its narrow width. The distance to the vehicle in front will be too short.

Obstructions and stationary vehicles

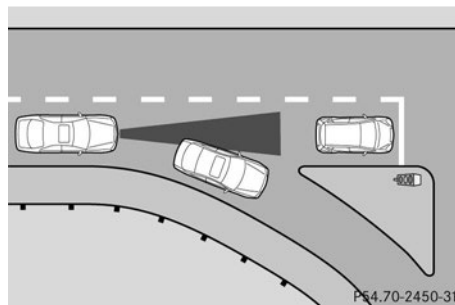

DISTRONIC PLUS does not brake for obstacles or stationary vehicles. If, for

example, the detected vehicle turns a corner and reveals an obstacle or stationary vehicle, DISTRONIC PLUS will not brake for these.

Crossing vehicles

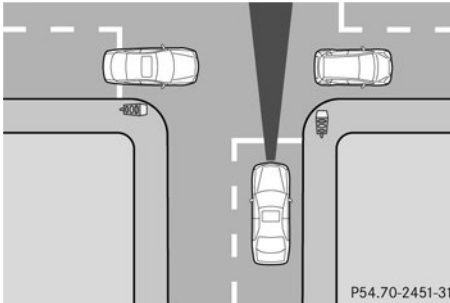

DISTRONIC PLUS may detect vehicles that are crossing your lane by mistake. Activating DISTRONIC PLUS at traffic lights with crossing traffic, for example, could cause your vehicle to pull away unintentionally.

HOLD function

Important safety notes

WARNING

When leaving the vehicle, it can still roll away despite being braked by the HOLD function if:

- there is a malfunction in the system or in the voltage supply.
- the HOLD function has been deactivated by pressing the accelerator pedal or the brake pedal, e.g. by a vehicle occupant.
- the electrical system in the engine compartment, the battery or the fuses have been tampered with.
- the battery is disconnected

There is a risk of an accident.

If you wish to exit the vehicle, always turn off the HOLD function and secure the vehicle against rolling away.

! If DISTRONIC PLUS or the HOLD function is activated, the vehicle brakes automatically in certain situations. To prevent damage to the vehicle, deactivate DISTRONIC PLUS and the HOLD function in the following or other similar situations:

- when towing the vehicle
- in the car wash

Deactivating the HOLD function (▷ page 172).

General notes

The HOLD function can assist the driver in the following situations:

- when pulling away, especially on steep slopes
- when maneuvering on steep slopes
- when waiting in traffic

The vehicle is kept stationary without the driver having to depress the brake pedal.

The braking effect is canceled and the HOLD function deactivated when you depress the accelerator pedal to pull away.

Activation conditions

You can activate the HOLD function if:

- the vehicle is stationary
- the engine is running or if it has been automatically switched off by the ECO start/stop function
- the driver's door is closed or your seat belt is fastened
- the electric parking brake is released
- the transmission position **D**, **R** or **N** is engaged while driving a vehicle with an automatic transmission
- DISTRONIC PLUS is deactivated

Activating the HOLD function



Example: vehicles with a color multifunction display

- ▶ Make sure that the activation conditions are met.
- ▶ Depress the brake pedal.
- ▶ Quickly depress the brake pedal further until ① appears in the multifunction display. The HOLD function is activated. You can release the brake pedal.

i If depressing the brake pedal the first time does not activate the HOLD function, wait briefly and then try again.

Deactivating the HOLD function

The HOLD function is deactivated automatically if:

- you accelerate. On vehicles with automatic transmission: only when the transmission is in position **D** or **R**.
 - the transmission is in position **P** on vehicles with automatic transmission.
 - you depress the brake pedal again with a certain amount of pressure until ① disappears from the multifunction display.
 - you secure the vehicle using the electric parking brake.
 - you activate DISTRONIC PLUS.
- i** After a time, the electric parking brake secures the vehicle and relieves the service brake.

The electric parking brake automatically secures the vehicle if the HOLD function is activated and:

- the driver's door is open and the driver's seat belt is unfastened.
- the engine is switched off, unless it is automatically switched off by the ECO start/stop function.
- a system malfunction occurs.
- the power supply is not sufficient.

If a malfunction occurs, then the transmission may be shifted into position **P** automatically.

PARKTRONIC

Important safety notes

PARKTRONIC is an electronic parking aid with ultrasonic sensors. It monitors the area around your vehicle using six sensors in the front bumper and four sensors in the rear bumper. PARKTRONIC indicates visually and audibly the distance between your vehicle and an object.

PARKTRONIC is only an aid. It is not a replacement for your attention to your immediate surroundings. You are always responsible for safe maneuvering, parking and exiting a parking space. When maneuvering, parking or pulling out of a parking space, make sure that there are no persons, animals or objects in the area in which you are maneuvering.

! When parking, pay particular attention to objects above or below the sensors, such as flower pots or trailer drawbars. PARKTRONIC does not detect such objects when they are in the immediate vicinity of the vehicle. You could damage the vehicle or the objects.

The sensors may not detect snow and other objects that absorb ultrasonic waves.

Ultrasonic sources such as an automatic car wash, the compressed-air brakes on a

truck or a pneumatic drill could cause PARKTRONIC to malfunction.

PARKTRONIC may not function correctly on uneven terrain.

PARKTRONIC is activated automatically when you:

- switch on the ignition
- shift the transmission to position **D**, **R** or **N**
- release the electric parking brake

PARKTRONIC is deactivated at speeds above 11 mph (18 km/h). It is reactivated at lower speeds.

Range of the sensors

General notes

PARKTRONIC does not take objects into consideration that are:

- below the detection range, e.g. people, animals or objects
- above the detection range, e.g. overhanging loads, truck overhangs or loading ramps.

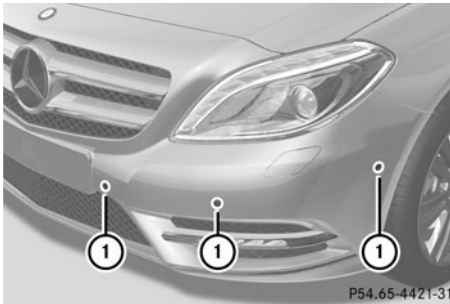

① Sensors in the front bumper, left-hand side (example)



Side view

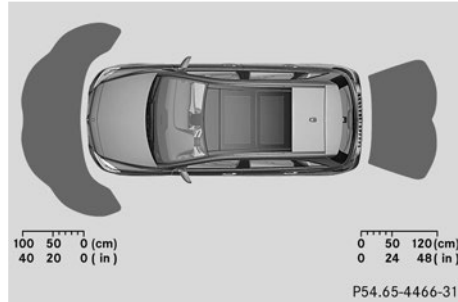

Top view

The sensors must be free from dirt, ice or slush. They can otherwise not function correctly. Clean the sensors regularly, taking care not to scratch or damage them (▷ page 289).

Front sensors

Center	Approx. 40in (approx. 100cm)
Corners	Approx. 24in (approx. 60cm)

Rear sensors

Center	Approx. 48 in (approx. 120 cm)
Corners	Approx. 32in (approx. 80cm)

Minimum distance

Center	Approx. 8in (approx. 20cm)
Corners	Approx. 8in (approx. 20cm)

If there is an obstacle within this range, the relevant warning displays light up and a warning tone sounds. If the distance falls below the minimum, the distance may no longer be shown.

Warning displays

The warning displays show the distance between the sensors and the obstacle. The warning display for the front area is located

P54.65-4421-31

P54.65-4465-31

P54.65-4466-31

on the dashboard above the center air vents. The warning display for the rear area is located on the headliner in the rear compartment.

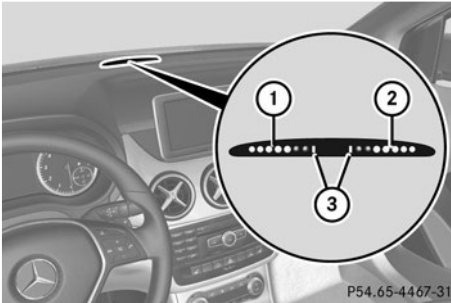

Warning display for the front area

- ① Segments on the left-hand side of the vehicle
- ② Segments on the right-hand side of the vehicle
- ③ Segments showing operational readiness

The warning display for each side of the vehicle is divided into five yellow and two red segments. PARKTRONIC is operational if yellow segments showing operational readiness ③ light up.

The selected transmission position and the direction in which the vehicle is rolling determine which warning display is active when the engine is running.

Transmission position	Warning display
D	Front area activated
R, N or the vehicle is rolling backwards	Rear and front areas activated
P	No areas activated

One or more segments light up as the vehicle approaches an obstacle, depending on the vehicle's distance from the obstacle.

From the:

- sixth segment onwards, you will hear an intermittent warning tone for approximately two seconds.
- seventh segment onwards, you will hear a warning tone for approximately two seconds. This indicates that you have now reached the minimum distance.

Deactivating/activating PARKTRONIC

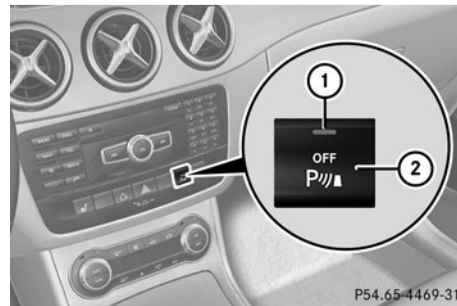

- ① Indicator lamp
- ② To deactivate/activate PARKTRONIC

If indicator lamp ① lights up, PARKTRONIC is deactivated.

- ❗ PARKTRONIC is automatically activated when you turn the SmartKey to position 2 in the ignition lock.

Problems with PARKTRONIC

Problem	Possible causes/consequences and ► Solutions
Only the red segments in the PARKTRONIC warning displays are lit. You also hear a warning tone for approximately two seconds. PARKTRONIC is deactivated after approximately 20 seconds, and the indicator lamp in the PARKTRONIC button lights up.	<p>PARKTRONIC has malfunctioned and has switched off.</p> <ul style="list-style-type: none"> ► If problems persist, have PARKTRONIC checked at a qualified specialist workshop.
Only the red segments in the PARKTRONIC warning displays are lit. PARKTRONIC is deactivated after approximately 20 seconds.	<p>The PARKTRONIC sensors are dirty or there is interference.</p> <ul style="list-style-type: none"> ► Clean the PARKTRONIC sensors (► page 289). ► Switch the ignition back on. <p>The problem may be caused by an external source of radio or ultrasound waves.</p> <ul style="list-style-type: none"> ► See if PARKTRONIC functions in a different location.

Active Parking Assist

General notes

Active Parking Assist is an electronic parking aid with ultrasound. It measures the road on both sides of the vehicle. A parking symbol indicates a suitable parking space. Active steering intervention can assist you during maneuvering and parking. You may also use PARKTRONIC (► page 172).

Important safety notes

Active Parking Assist is merely an aid. It is not a replacement for your attention to your immediate surroundings. You are always responsible for safe maneuvering, parking and exiting a parking space. Make sure that no persons, animals or objects are in the maneuvering range.

When PARKTRONIC is switched off, Active Parking Assist is also unavailable.

WARNING

The vehicle swings out when parking and in doing so could cross into the opposite lane. This could result in a collision with another road user. There is a risk of an accident.

Pay attention to other road users when parking. Stop the vehicle if necessary or cancel the Active Parking Assist parking procedure.

! If unavoidable, you should drive over obstacles such as curbs slowly and not at a sharp angle. Otherwise, you may damage the wheels or tires.

Active Parking Assist may possibly indicate parking spaces which are not suitable for parking, for example:

- where parking or stopping is prohibited
- in front of driveways or entrances and exits
- on unsuitable surfaces

Parking tips:

- On narrow roads, drive as close to the parking space as possible.
- Parking spaces that are littered or overgrown might be identified or measured incorrectly.
- Parking spaces that are partially occupied by trailer drawbars might not be identified as such or be measured incorrectly.
- Snowfall or heavy rain may lead to a parking space being measured inaccurately.
- Pay attention to the PARKTRONIC (▷ page 173) warning messages during the parking procedure.
- You can intervene in the steering procedure to correct it at any time. Active Parking Assist will then be canceled.
- When transporting a load which protrudes from your vehicle, you should not use Active Parking Assist.
- Never use Active Parking Assist when snow chains are installed.
- Make sure that the tire pressures are always correct. This has a direct influence on the parking characteristics of the vehicle.

Use Active Parking Assist for parking spaces:

- that are parallel to the direction of travel
- that are on straight roads, not bends
- that are on the same level as the road, e.g. not on the pavement

Detecting parking spaces

Objects located above the height range of Active Parking Assist will not be detected when the parking space is measured. These are not taken into account when the parking

procedure is calculated, e.g. overhanging loads, tail sections or loading ramps of goods vehicles.

WARNING

If there are objects above the detection range, Active Parking Assist may turn prematurely. You may cause a collision as a result. There is a risk of an accident.

If there are objects above the detection range, stop and deactivate Active Parking Assist.

For further information on the detection range (▷ page 173).

Active Parking Assist does not support you with parking spaces parallel to the direction of travel if:

- the parking space is on a curb
- the parking space is apparently blocked, for example by foliage or grass paving blocks
- the range of movement is too small
- the parking space is bordered by an obstacle which is not clearly defined such as a tree or a trailer

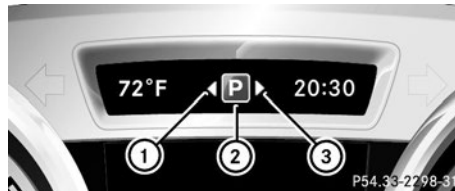

- ① Detected parking space on the left
- ② Parking symbol
- ③ Detected parking space on the right

Active Parking Assist is automatically activated when driving forwards. The system is operational at speeds of up to approximately 22 mph (35 km/h). While in operation, the system independently locates and measures parking spaces on both sides of the vehicle.

Active Parking Assist will only detect parking spaces:

- that are parallel to the direction of travel
- that are at least 59 in (1.5 m) wide
- that are at least 51 in (1.3 m) longer than your vehicle

i In the case of parking spaces that are at right angles to the direction of travel, please ensure that the parking space is long enough to accommodate your vehicle.

When driving at speeds below 19 mph (30 km/h), you will see parking symbol as a status indicator in the instrument cluster. When a parking space has been detected, an arrow towards the right or the left also appears. By default, Active Parking Assist only displays parking spaces on the front-passenger side. Parking spaces on the driver's side are displayed as soon as the turn signal on the driver's side is activated. When parking on the driver's side, this must remain switched on until you acknowledge the use of Active Parking Assist by pressing the **OK** button on the multifunction steering wheel. A parking space is displayed while you are driving past it, and until you are approximately 50 ft (15 m) away from it.

Parking

WARNING

Active Parking Assist merely aids you by intervening actively in the steering. If you do not brake there is a risk of an accident. Always apply the brakes yourself when maneuvering and parking.

- ▶ Stop the vehicle when the parking space symbol shows the desired parking space in the instrument cluster.
- ▶ Shift the transmission to position **R**. The **Start Park Assist? Yes: OK No: ** message appears in the multifunction display.

- ▶ **To cancel the procedure:** press the **** button on the multifunction steering wheel or pull away.

or

- ▶ **To park using Active Parking Assist:** press the **OK** button on the multifunction steering wheel.

The **Park Assist Active Accelerate and Brake Observe Surroundings** message appears in the multifunction display.

- ▶ Let go of the multifunction steering wheel.
- ▶ Back up the vehicle, being ready to brake at all times. Do not exceed a maximum speed of approximately 5 mph (10 km/h) when backing up. Otherwise Active Parking Assist will be canceled.

i In tight parking spaces, you will achieve the best parking results by backing up as far as possible. When doing so, also observe the PARKTRONIC messages.

- ▶ Stop as soon as PARKTRONIC sounds the continuous warning tone, if not before. Maneuvering may be required in tight parking spaces.

The **Park Assist Active Select D Observe Surroundings** message appears in the multifunction display.

- ▶ Shift the transmission to position **D** while the vehicle is stationary. Active Parking Assist immediately steers in the other direction.

The **Park Assist Active Accelerate and Brake Observe Surroundings** message appears in the multifunction display.

- ▶ **i** You will achieve the best results by waiting for the steering procedure to complete before pulling away.
- ▶ Drive forwards and be ready to brake at all times.
- ▶ Stop as soon as PARKTRONIC sounds the continuous warning tone, if not before.

The **Park Assist Active Select R Observe Surroundings** message appears in the multifunction display.

Further transmission shifts may be necessary.

As soon as the parking procedure is complete, the **Park Assist Finished** message appears and a warning tone sounds.

Active Parking Assist no longer supports you with steering interventions. When Active Parking Assist is finished, you must steer again yourself. PARKTRONIC is still available.

- ▶ Maneuver if necessary.
- ▶ Always observe the warning messages displayed by PARKTRONIC (▷ page 173).

Parking tips:

- The way your vehicle is positioned in the parking space after parking is dependent on various factors. These include the position and shape of the vehicles parked in front and behind it and the conditions of the location. It may be the case that Active Parking Assist guides you too far into a parking space, or not far enough into it. In some cases, it may also lead you across or onto the curb. If necessary, you should cancel the parking procedure with Active Parking Assist.
- You can also engage forward gear prematurely. The vehicle redirects and does not drive as far into the parking space. Should a gear be changed too early, the parking procedure will be canceled. A sensible parking position can no longer be achieved from this position.

Exiting a parking space



In order that Active Parking Assist can support you when you exit the parking space:

- the border of the parking space must be high enough. A curb is too small, for example.
- the border of the parking space must not be too wide, as the position of the vehicle must not exceed an angle of 45° to the

starting position as it is maneuvering into the parking space.

- a maneuvering distance of at least 3.3 ft (1.0 m) must be available.

Active Parking Assist can only assist you with exiting a parking space if you have parked the vehicle parallel to the direction of travel using Active Parking Assist.

- ▶ Start the engine.
- ▶ Switch on the turn signal in the direction you are pulling away.
- ▶ Shift the transmission to position **D** or **R**. The **Start Park Assist? Yes: OK No:**  message appears in the multifunction display.
- ▶ **To cancel the procedure:** press the  button on the multifunction steering wheel or pull away.

or

- ▶ **To exit a parking space using Active Parking Assist:** press the  button on the multifunction steering wheel. The **Park Assist Active Accelerate and Brake Observe Surroundings** message appears in the multifunction display.
 - ▶ Let go of the multifunction steering wheel.
 - ▶ Reverse the vehicle or drive forwards, being ready to brake at all times. Do not exceed a maximum speed of approximately 6 mph (10 km/h) when exiting a parking space. Otherwise Active Parking Assist will be canceled.
 - ▶ Stop when PARKTRONIC sounds the continuous warning tone, if not before.
 - ▶ Shift the transmission to position **D** or **R** as required while the vehicle is stationary. Active Parking Assist immediately steers in the other direction. The **Park Assist Active Accelerate and Brake Observe Surroundings** message appears in the multifunction display.
- i** You will achieve the best results by waiting for the steering procedure to complete before pulling away.

If you back up after activation, the steering wheel is moved to the straight-ahead position.

- ▶ Drive forwards and back up as prompted by the PARKTRONIC warning displays, several times if necessary.
- ▶ Stop as soon as PARKTRONIC sounds the continuous warning tone, if not before.

Once you have exited the parking space completely, the steering wheel is moved to the straight-ahead position. You hear a tone and the message **Park Assist Finished** appears in the multifunction display. You will then have to steer and merge into traffic on your own. PARKTRONIC is still available. You can take over the steering, before the vehicle has exited the parking space completely. This is useful, for example when you recognize that it is already possible to pull out of the parking space.

Canceling Active Parking Assist

You can cancel Active Parking Assist at any time.

- ▶ Stop the movement of the multifunction steering wheel or steer yourself. Active Parking Assist will be canceled at once. The **Park Assist Canceled** message appears in the multifunction display.

or

- ▶ Press the PARKTRONIC button on the center console (▷ page 174). PARKTRONIC is switched off and Active Parking Assist is immediately canceled. The **Park Assist Canceled** message appears in the multifunction display.

Active Parking Assist is canceled automatically if:

- the electric parking brake is engaged
- transmission position **P** is selected
- parking using Active Parking Assist is no longer possible

- you are driving faster than 6 mph (10 km/h)
- a wheel spins, ESP® intervenes or fails. The  warning lamp lights up in the instrument cluster.

A warning tone sounds. The parking symbol disappears and the multifunction display shows the **Park Assist Canceled** message.

If Active Parking Assist is canceled, you must steer again yourself.

Rear view camera

General notes

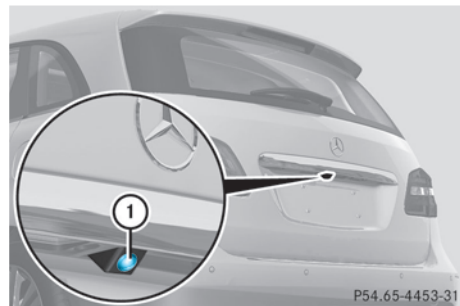

Rear view camera ① is in the handle on the tailgate.

The rear view camera is an optical parking and maneuvering aid. It uses guide lines to show the area behind your vehicle in the Audio/COMAND display.

The area behind the vehicle is displayed as a mirror image, as in the rear view mirror.

- ❗ The text of messages shown in the COMAND display depends on the language setting. The following are examples of rear view camera messages in the COMAND display.

Observe the notes on cleaning (▷ page 289).

Important safety notes

The rear view camera is only an aid. It is not a replacement for your attention to your immediate surroundings. You are always responsible for safe maneuvering and parking. When maneuvering or parking, make sure that there are no persons, animals or objects in the area in which you are maneuvering.

Under the following circumstances, the rear view camera will not function, or will function in a limited manner:

- the tailgate is open
- in heavy rain, snow or fog
- at night or in very dark places
- if the camera is exposed to very bright light
- if the area is lit by fluorescent light or LED lighting (the display may flicker)
- if there is a sudden change in temperature, e.g. when driving into a heated garage in winter
- if the camera lens is dirty or obstructed
- if the rear of your vehicle is damaged. In this event, have the camera position and setting checked at a qualified specialist workshop

The field of vision and other functions of the rear view camera may be restricted due to additional accessories on the rear of the vehicle (e.g. license plate holder, bicycle rack).

Activating/deactivating the rear view camera

- ▶ **To activate:** make sure that the SmartKey is in position **2** in the ignition lock.
- ▶ Make sure that in the audio system/COMAND, the "Activation by R gear" function is selected; see the separate

operating instructions for the audio system/COMAND.

- ▶ Engage reverse gear.
Guide lines are used to show the area behind the vehicle in the Audio/COMAND display.

To deactivate: the rear view camera deactivates if you shift the transmission to **P** on vehicles with automatic transmission or after driving forwards a short distance.

Displays in the Audio/COMAND display

The rear view camera may show a distorted view of obstacles, show them incorrectly or not at all. The rear view camera does not show objects in the following positions:

- very close to the rear bumper
- under the rear bumper
- in the area immediately above the tailgate handle

! Objects not at ground level may appear to be further away than they actually are, e.g.:

- the bumper of a parked vehicle
- the drawbar of a trailer
- the ball coupling of a trailer tow hitch
- the rear section of an HGV
- a slanted post

Use the guidelines only for orientation. Approach objects no further than the bottom-most guideline.

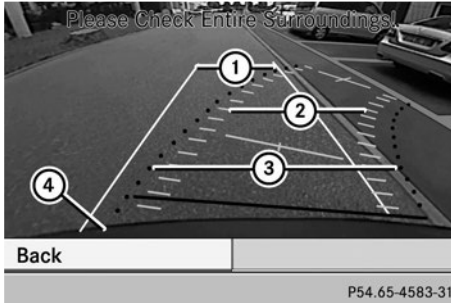

Lanes

- ① White guide line without turning the steering wheel, vehicle width including the exterior mirrors (static)
- ② Yellow lane marking tires at current steering wheel angle, vehicle width to the outer side of the wheels (dynamic)
- ③ Red guide line for the vehicle width including the exterior mirrors, for current steering wheel angle (dynamic)
- ④ Bumper

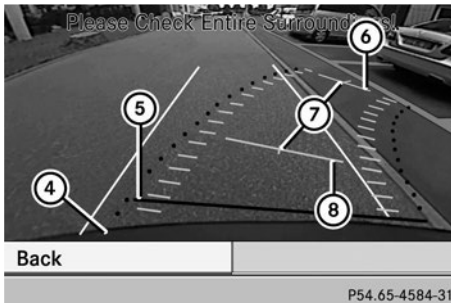

Guide lines

- ④ Bumper
- ⑤ Red guide line at a distance of approximately 10 in (0.25 m) from the rear of the vehicle
- ⑥ Yellow guide line at a distance of approximately 13 ft (4.0 m) from the rear of the vehicle
- ⑦ Vehicle center axle (marker assistance)
- ⑧ Yellow guide line at a distance of approximately 3 ft (1.0 m) from the rear of the vehicle

The lanes and guide lines are only displayed if you have engaged reverse gear.

The distance specifications only apply to objects that are at ground level.



Additional displays on vehicles with PARKTRONIC and COMAND

- ① Front warning display
- ② Additional PARKTRONIC measurement operational readiness indicator
- ③ Rear warning display

Vehicles with PARKTRONIC and COMAND: if PARKTRONIC is operational (> page 172), an additional operational readiness indicator will appear in COMAND display ②. If the PARKTRONIC warning displays are active or light up, warning displays ① and ③ are also active or light up correspondingly in the COMAND display.

"Reverse parking" function

- ▶ Make sure that the rear view camera is activated and the "Reverse parking" function is selected; see the separate operating instructions for the audio system/COMAND. The lane and the guide lines are shown.

Backing up straight into a parking space without turning the steering wheel



- ① White lane with steering wheel straight
 - ② Yellow guide line at a distance of approximately 3 ft (1.0 m) from the rear of the vehicle
 - ③ Red guide line at a distance of approximately 10 in (0.25 m) from the rear of the vehicle
- ▶ With the help of white lane ①, check whether the vehicle will fit into the parking space.
 - ▶ Using the white lane as a guide, carefully back up until you reach the end position. Red guide line ③ is then at the end of the parking space. The vehicle is almost parallel in the parking space.

Reverse perpendicular parking with the steering wheel at an angle

- ▶ Drive past the parking space and bring the vehicle to a standstill.

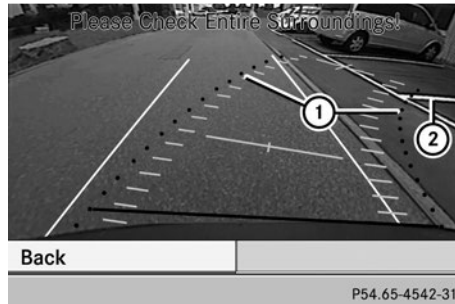

Turning the steering wheel

- ① Red lane indicating the route the vehicle will take with the steering wheel in its current position
 - ② Parking space marking
- ▶ While the vehicle is at a standstill, turn the steering wheel in the direction of the parking space until the red lane reaches parking space marking ②.
 - ▶ Keep the steering wheel in that position and back up carefully.



Backing up with the steering wheel turned

- ① Red lane indicating the route the vehicle will take with the steering wheel in its current position
- ▶ Stop the vehicle when it is almost exactly in front of the parking space. The white lane should be as close to parallel with the parking space marking as possible.



Driving to the final position

- ① White lane at current steering wheel angle
 - ② Parking space marking
- ▶ Turn the steering wheel to the center position while the vehicle is stationary.

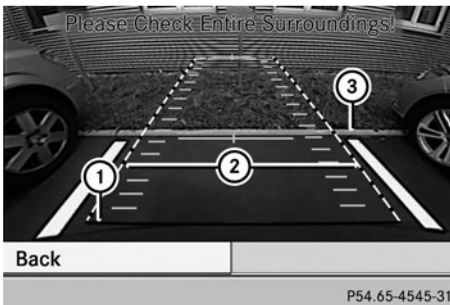

- ① Red guide line at a distance of approximately 10 in (0.25 m) from the rear of the vehicle
 - ② White lane with steering wheel straight
 - ③ End of parking space
- ▶ Back up carefully until you have reached the final position. Red guide line ① is then at end of parking space ③. The vehicle is almost parallel in the parking space.

ATTENTION ASSIST

General notes

ATTENTION ASSIST helps you during long, monotonous journeys, such as on highways. It is active in the range between 50 mph (80 km/h) and 112 mph (180 km/h).

If ATTENTION ASSIST detects typical indicators of fatigue or increasing lapses in concentration on the part of the driver, it suggests you take a break.

Important safety notes

ATTENTION ASSIST is only an aid to the driver. It might not always recognize fatigue or increasing inattentiveness in time or fail to recognize them at all. The system is not a substitute for a well-rested and attentive driver.

ATTENTION ASSIST assesses your level of fatigue or lapses in concentration by taking the following criteria into account:

- your personal driving style, e.g. steering characteristics
- journey details, e.g. time of day and length of journey

The functionality of ATTENTION ASSIST is restricted and warnings may be delayed or not occur at all:

- if the road condition is poor, e.g. if the surface is uneven or if there are potholes
- if there is a strong side wind
- if you have adopted a sporty driving style with high cornering speeds or high rates of acceleration
- if you are predominantly driving slower than 50 mph (80 km/h) or faster than 112 mph (180 km/h)
- if you are currently using COMAND or making a telephone call with it
- if the time has been set incorrectly
- in active driving situations, such as when you change lanes or change your speed

Warning and display messages in the black and white multifunction display



- ▶ Activate ATTENTION ASSIST using the on-board computer (▷ page 201). Symbol ① appears in the multifunction display.

If ATTENTION ASSIST is active, it will not warn you until at least 20 minutes after your journey has begun. You then hear an intermittent warning tone twice and the **Attention Assist: Drowsiness Detected** message appears in the multifunction display.

- ▶ If necessary, take a break.
- ▶ Press the **OK** button to confirm the message.

On long journeys, take regular breaks in good time to allow yourself to rest properly. If you do not take a break, you will be warned again after 15 minutes at the earliest. The precondition for this is that ATTENTION ASSIST still detects typical indicators of fatigue or increasing lapses in concentration.

ATTENTION ASSIST is reset when you continue your journey and starts assessing your tiredness again if:

- you switch off the engine.
- you take off your seat belt and open the driver's door, e.g. for a change of drivers or to take a break.

Warning and display messages in the color multifunction display

- ▶ Activate ATTENTION ASSIST using the on-board computer (▷ page 201).

If ATTENTION ASSIST is active, you will be warned no sooner than 20 minutes after your journey has begun. You then hear an intermittent warning tone twice and the **Attention Assist: Take a break!** message appears in the multifunction display.

- ▶ If necessary, take a break.
- ▶ Press the **OK** or **←** button to confirm the message.

On long journeys, take regular breaks in good time to allow yourself to rest properly. If you do not take a break, you will be warned again after 15 minutes at the earliest. The precondition for this is that ATTENTION ASSIST still detects typical indicators of fatigue or increasing lapses in concentration.

ATTENTION ASSIST is reset when you continue your journey and starts assessing your tiredness again if:

- you switch off the engine.
- you take off your seat belt and open the driver's door, e.g. for a change of drivers or to take a break.

When ATTENTION ASSIST is deactivated, the **OFF** symbol appears in the multifunction display in the assistance graphics display.

Lane Tracking package

General notes

The Lane Tracking package consists of Blind Spot Assist (▷ page 184) and Lane Keeping Assist (▷ page 186).

Blind Spot Assist

General notes

Blind Spot Assist uses a radar sensor system to monitor the areas on both sides of your vehicle. It supports you from a speed of approximately 20 mph (30 km/h). A warning display in the exterior mirrors draws your attention to vehicles detected in the

monitored area. If you then switch on the corresponding turn signal to change lanes, you will also receive a visual and audible collision warning. For this purpose, Blind Spot Assist uses sensors in the rear bumper.

Important safety notes

WARNING

Blind Spot Assist does not react to:

- vehicles overtaken too closely on the side, placing them in the blind spot area
- vehicles which approach with a large speed differential and overtake your vehicle

As a result, Blind Spot Assist may not give warnings in such situations. There is a risk of an accident.

Always observe the traffic conditions carefully, and maintain a safe lateral distance.

Blind Spot Assist is only an aid. It may fail to detect some vehicles and is no substitute for attentive driving.

USA only:

This device has been approved by the FCC as a "Vehicular Radar System". The radar sensor is intended for use in an automotive radar system only. Removing, tampering with, or altering the device will void any warranties, and is not permitted by the FCC. Do not tamper with, alter, or use in any non-approved way.

Any unauthorized modification to this device could void the user's authority to operate the equipment.

Monitoring range of the sensors

In particular, the detection of obstacles can be impaired if:

- dirt on the sensors or anything else covering the sensors
- there is poor visibility, e.g. due to fog, heavy rain or snow
- a narrow vehicle traveling in front, e.g. a motorbike or bicycle
- the road has very wide lanes

- the road has narrow lanes
 - you are not driving in the middle of the lane
 - there are barriers or similar lane borders
- Vehicles in the monitoring range are then not indicated.

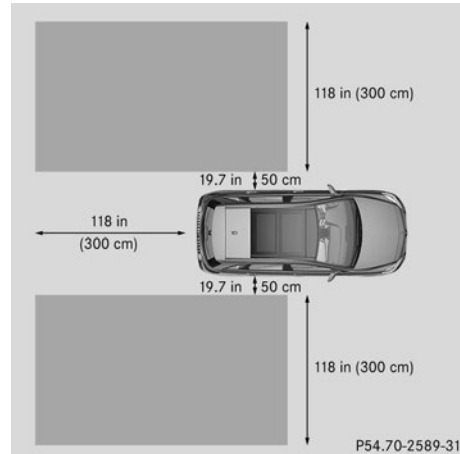

Blind Spot Assist monitors the area up to 10 ft (3.0 m) behind your vehicle and directly next to your vehicle, as shown in the diagram. For this purpose, Blind Spot Assist uses radar sensors in the rear bumper.

If the lanes are narrow, vehicles driving in the lane beyond the lane next to your vehicle may be indicated, especially if the vehicles are not driving in the middle of their lane. This may be the case if the vehicles are driving on the inner side of their lane.

Due to the nature of the system:

- warnings may be issued in error when driving close to crash barriers or similar solid lane borders.
- warnings may be interrupted when driving alongside particularly long vehicles, e.g. trucks, for a prolonged time.

The two sensors for Blind Spot Assist are integrated into the sides of the rear bumper. Make sure that the bumper is free of dirt, ice or slush in the vicinity of the sensors. For example, the radar sensors must not be covered by bicycle racks or overhanging loads. Following a severe impact or in the

event of damage to the bumpers, have the function of the radar sensors checked at a qualified specialist workshop. Blind Spot Assist may otherwise not work properly.

Indicator and warning display

Blind Spot Assist is not active at speeds below approximately 20 mph (30 km/h). Vehicles in the monitoring range are then not indicated.

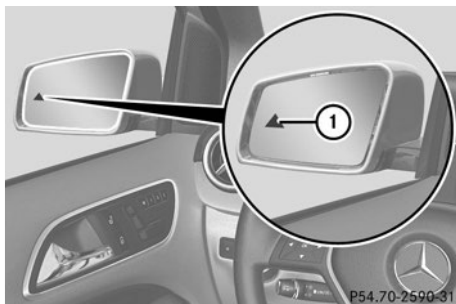

① Yellow indicator lamp/red warning lamp

When Blind Spot Assist is activated, indicator lamp ① in the exterior mirrors lights up yellow at speeds of up to 20 mph (30 km/h). At speeds above 20 mph (30 km/h), the indicator lamp goes out and Blind Spot Assist is operational.

If a vehicle is detected within the monitoring range of Blind Spot Assist at speeds above 20 mph (30 km/h), then warning lamp ① on the corresponding side lights up red. This warning is always emitted when a vehicle enters the blind spot monitoring range from behind or from the side. When you overtake a vehicle, the warning only occurs if the difference in speed is less than 7 mph (12 km/h).

The yellow indicator lamp goes out if reverse gear is engaged. In this event, Blind Spot Assist is no longer active.

The brightness of the indicator/warning lamps is adjusted automatically according to the ambient light.

Collision warning

If a vehicle is detected in the monitoring range of Blind Spot Assist and you switch on the corresponding turn signal, a double warning tone sounds. Red warning lamp ① flashes. If the turn signal remains on, vehicles detected are indicated by the flashing of red warning lamp ①. There are no further warning tones.

Switching on Blind Spot Assist

- ▶ Make sure that Blind Spot Assist is activated in the on-board computer (▷ page 201).
- ▶ Turn the SmartKey to position **2** in the ignition lock.
Warning lamps ① in the exterior mirrors light up red for approximately 1.5 seconds and then turn yellow.

Lane Keeping Assist

General notes

Lane Keeping Assist monitors the area in front of your vehicle by means of a camera at the top of the windshield. Lane Keeping Assist detects lane markings on the road and warns you before you leave your lane unintentionally.

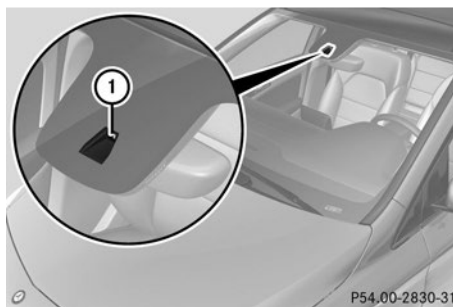

① Lane Keeping Assist camera

If you select **km** on the on-board computer in the **Display Unit Speed-/Odometer** function (▷ page 202), Lane Keeping Assist is active starting at a speed of 60 km/h. If the **miles** display unit is selected, the assistance range begins at 40 mph.

Important safety notes

WARNING

Lane Keeping Assist may not always clearly recognize lane markings.

In this case, Lane Keeping Assist may:

- give an unnecessary warning
- not give a warning

There is a risk of an accident.

Always pay particular attention to the traffic situation and stay in lane, in particular if warned by Lane Keeping Assist.

WARNING

The Lane Keeping Assist warning does not return the vehicle to the original lane. There is a risk of an accident.

You should always steer, brake or accelerate yourself, in particular if warned by Lane Keeping Assist.

If you fail to adapt your driving style, Lane Keeping Assist can neither reduce the risk of an accident nor override the laws of physics. Lane Keeping Assist cannot take into account the road, traffic and weather conditions. Lane Keeping Assist is merely an aid. You are responsible for the distance to the vehicle in front, for vehicle speed, for braking in good time and for staying in your lane.

The Lane Keeping Assist does not keep the vehicle in the lane.

The system may be impaired or may not function if:

- there is poor visibility, e.g. due to insufficient illumination of the road, or due to snow, rain, fog or spray
- there is glare, e.g. from oncoming traffic, the sun or reflections (e.g. when the road surface is wet)
- the windshield is dirty, fogged up, damaged or covered, for instance by a sticker, in the vicinity of the camera
- there are no, several or unclear lane markings for a lane, e.g. in areas with road construction work

- the lane markings are worn away, dark or covered up, e.g. by dirt or snow
- the distance to the vehicle in front is too small and the lane markings thus cannot be detected
- the lane markings change quickly, e.g. lanes branch off, cross one another or merge
- the road is narrow and winding
- there are strong shadows cast on the lane

A warning may be given if a front wheel passes over a lane marking. It will warn you by means of intermittent vibration in the steering wheel for up to 1.5 seconds.

Switching on Lane Keeping Assist



Example: vehicles with a black and white multifunction display

- Switch on Active Lane Keeping Assist using the on-board computer; to do so, select **Standard** or **Adaptive** (► page 201).

Vehicles with a black and white multifunction display: symbol ① appears in the multifunction display.

If you drive at speeds above 40 mph (60 km/h) and lane markings are detected, symbol ① is highlighted. Lane Keeping Assist is ready for use.

Vehicles with a color multifunction display: if you drive at speeds above 40 mph (60 km/h) and lane markings are detected, the lane markings in the assistance graphics display (► page 199) are shown in green.

When **Standard** is selected, no warning vibration occurs if:

- you switch on the turn signals. In this event, the warnings are suppressed for a certain period of time.
- a driving safety system intervenes, such as ABS, BAS or ESP®.

When **Adaptive** is selected, no warning vibration occurs if:

- you switch on the turn signals. In this event, the warnings are suppressed for a certain period of time.
- a driving safety system intervenes, e.g. ABS, BAS or ESP®.
- you accelerate hard, e.g. kickdown.
- you brake hard.
- you steer actively, e.g. swerve to avoid an obstacle or change lanes quickly.
- you cut the corner on a sharp bend.

In order that you are warned only when necessary and in good time if you cross the lane marking, the system recognizes certain conditions and warns you accordingly.

The warning vibration occurs earlier if:

- you approach the outer lane marking on a bend.
- the road has very wide lanes, e.g. a freeway.
- the system recognizes solid lane markings.

The warning vibration occurs later if:

- the road has narrow lanes.
- you cut the corner on a bend.

Useful information	190
Important safety notes	190
Displays and operation	190
Menus and submenus	193
Display messages	207
Warning and indicator lamps in the instrument cluster	237

Useful information

- i** This Operator's Manual describes all models and all standard and optional equipment of your vehicle available at the time of publication of the Operator's Manual. Country-specific differences are possible. Please note that your vehicle may not be equipped with all features described. This also applies to safety-related systems and functions.
- i** Read the information on qualified specialist workshops: (> page 25).

Important safety notes

WARNING

If you operate information systems and communication equipment integrated in the vehicle while driving, you will be distracted from traffic conditions. You could also lose control of the vehicle. There is a risk of an accident.

Only operate the equipment when the traffic situation permits. If you are not sure that this is possible, park the vehicle paying attention to traffic conditions and operate the equipment when the vehicle is stationary.

WARNING

If the instrument cluster has failed or malfunctioned, you may not recognize function restrictions in systems relevant to safety. The operating safety of your vehicle may be impaired. There is a risk of an accident.

Drive on carefully. Have the vehicle checked at a qualified specialist workshop immediately.

You must observe the legal requirements for the country in which you are currently driving when operating the on-board computer. The on-board computer only shows messages or warnings from certain systems in the



multifunction display. You should therefore make sure your vehicle is operating safely at all times. Otherwise, a vehicle that is not operating safely may cause an accident. For an overview, see the instrument panel illustration (> page 31).

Displays and operation

Instrument cluster lighting

The lighting in the instrument cluster, in the displays and the controls in the vehicle interior can be adjusted using the brightness control knob.

The brightness control knob is located on the bottom left of the instrument cluster (> page 31).

- ▶ Turn the brightness control knob clockwise or counter-clockwise.
If the light switch is set to **AUTO**,  or , the brightness is dependent upon the brightness of the ambient light.

- i** The light sensor in the instrument cluster automatically controls the brightness of the multifunction display.
In daylight, the displays in the instrument cluster are not illuminated.

Coolant temperature display

WARNING

Opening the hood when the engine is overheated or when there is a fire in the engine compartment could expose you to hot gases or other service products. There is a risk of injury.

Let an overheated engine cool down before opening the hood. If there is a fire in the engine compartment, keep the hood closed and contact the fire department.

- !** A display message is shown if the coolant temperature is too high.

If the coolant temperature is over 248 °F (120 °C), do not continue driving. The engine will otherwise be damaged.

The coolant temperature gauge is in the instrument cluster on the right-hand side.

Under normal operating conditions and with the specified coolant level, the coolant temperature may rise to 248 °F (120 °C).

Tachometer

! Do not drive in the overrevving range, as this could damage the engine.

The red band in the tachometer indicates the engine's overrevving range.

The fuel supply is interrupted to protect the engine when the red band is reached.

Outside temperature display

You should pay special attention to road conditions when temperatures are around freezing point.

The outside temperature display is in the multifunction display.

Changes in the outside temperature are displayed after a short delay.

Speedometer with segments

The speedometer is divided into segments on vehicles with DISTRONIC PLUS.

The segments in the speedometer indicate which speed range is available.

- Cruise control activated (▷ page 160):
The segments light up from the stored speed to the maximum speed.
- DISTRONIC PLUS activated (▷ page 162):
One or two segments in the set speed range light up.
- DISTRONIC PLUS detects a vehicle in front:

The segments between the speed of the vehicle in front and the stored speed light up.

Operating the on-board computer

Overview

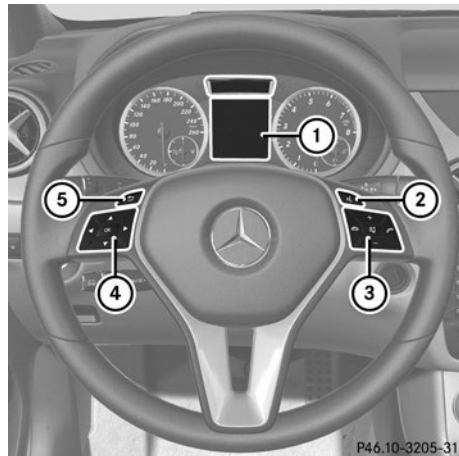







- ① Multifunction display
- ② Switches on the Voice Control System; see the separate operating instructions
- ③ Right control panel
- ④ Left control panel
- ⑤ Back button



► **To activate the on-board computer:** turn the SmartKey to position 1 in the ignition lock.



You can control the multifunction display and the settings in the on-board computer using the buttons on the multifunction steering wheel.

Left control panel



	• Calls up the menu and menu bar
	
	Press briefly:
	<ul style="list-style-type: none"> • Scrolls in lists • Selects a submenu or function • In the Audio menu: selects a stored station, an audio track or a video scene • In the Tel (telephone) menu: switches to the phone book and selects a name or telephone number
	Press and hold:
	<ul style="list-style-type: none"> • In the Audio menu: selects the previous/next station or selects an audio track or a video scene using rapid scrolling • In the Tel (Telephone) menu, starts rapid scrolling through the phone book
	<ul style="list-style-type: none"> • Confirms a selection/display message • In the Tel (telephone) menu: switches to the telephone book and starts dialing the selected number • In the Audio menu: stops the station search function at the desired station

Right control panel

	<ul style="list-style-type: none"> • Rejects or ends a call • Exits phone book/redial memory
	<ul style="list-style-type: none"> • Makes or accepts a call • Switches to the redial memory

	• Adjusts the volume
	
	• Mute

Back button

	Press briefly:
	<ul style="list-style-type: none"> • Back • Switches off the Voice Control System; see the separate operating instructions • Hides display messages/calls up the last Trip menu function used • Exits the telephone book/redial memory
	Press and hold:
	<ul style="list-style-type: none"> • Calls up the standard display in the Trip menu

Multifunction display



Black and white multifunction display

- ① Permanent display: outside temperature or speed (> page 203)
- ② Time
- ③ Text field

- ④ Menu bar
- ⑤ Drive program (▷ page 144)
- ⑥ Transmission position (▷ page 144)



Color multifunction display

- ① Permanent display: outside temperature or speed (▷ page 203)
- ② Time
- ③ Text field
- ④ Menu bar
- ⑤ Drive program (▷ page 144)
- ⑥ Transmission position (▷ page 144)

▶ **To show menu bar** ④: press the ◀ or ▶ button on the steering wheel.

Menu bar ④ disappears after a few seconds.

Text field ③ shows the selected menu or submenu as well as display messages.

i You can set the time using the audio system or COMAND, see the separate operating instructions.

The following messages may appear in the multifunction display:

- ↑ Shift recommendation (▷ page 147)
- ◀ P ▶ Active Parking Assist (▷ page 175)
- CRUISE** Cruise control (▷ page 160)

- Adaptive Highbeam Assist (▷ page 108)
- ECO start/stop function (▷ page 139)
- HOLD function (▷ page 171)

Menus and submenus

Menu overview

Operating the on-board computer (▷ page 191).

Depending on the equipment installed in the vehicle, you can call up the following menus:

- **Trip** menu (▷ page 193)
- **Navi** menu (navigation instructions) (▷ page 195)
- **Audio** menu (▷ page 196)
- **Tel** (telephone) menu (▷ page 197)
- **DriveAssist** (Assistance) menu (▷ page 199)
- **Serv.** menu (▷ page 202)
- **Sett.** menu (▷ page 202)

The **Audio**, **Navi** and **Tel** menus differ slightly in vehicles with Audio 20 and in vehicles with COMAND. The examples given in this Operator's Manual apply to vehicles equipped with COMAND.

Trip menu

Standard display

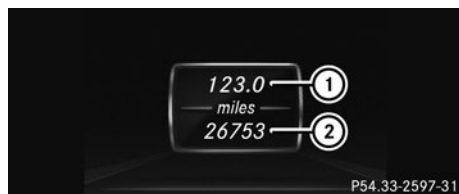

Example: standard display (color multifunction display)

▶ Press and hold the button on the steering wheel until the **Trip** menu with

trip odometer ① and odometer ② is shown.

Trip computer "From Start" or "From Reset"

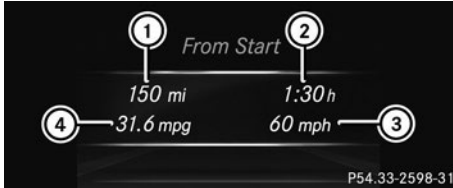

Example: "From Start" trip computer (color multifunction display)

- ① Distance
- ② Time
- ③ Average speed
- ④ Average fuel consumption

- ▶ Press the or button on the steering wheel to select the **Trip** menu.
- ▶ Press the or button to select **From Start** or **From Reset**.

The values in the **From Start** submenu are calculated from the start of a journey, while the values in the **From Reset** submenu are calculated from the last time the submenu was reset (▷ page 195).

The **From Start** trip computer is automatically reset when:

- the ignition has been switched off for more than four hours.
- 999 hours have been exceeded.
- 9,999 miles have been exceeded.

The **From Reset** trip computer is automatically reset if the value exceeds 9,999 hours or 99,999 miles.

ECO display



Example: ECO display (color multifunction display)

- ▶ Press the or button on the steering wheel to select the **Trip** menu.
- ▶ Press or to select **ECO DISPLAY**.

If the ignition remains switched off for longer than four hours, the ECO display will be automatically reset.

For further information on the ECO display, see (▷ page 156).

Displaying the range and current fuel consumption



Example: range and current fuel consumption (color multifunction display)

- ▶ Press the or button on the steering wheel to select the **Trip** menu.
- ▶ Press the or button to select the current fuel consumption and approximate range.

The approximate range that can be covered depends on the fuel level and your current driving style. If there is only a small amount of fuel left in the fuel tank, the display shows a vehicle being refueled instead of the range.

Digital speedometer

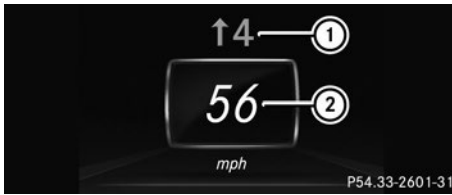

Example: digital speedometer (color multifunction display)

- ① Shift recommendation (▷ page 147)
- ② Digital speedometer
- ▶ Press the ◀ or ▶ button on the steering wheel to select the **Trip** menu.
- ▶ Press the ▲ or ▼ button to select the digital speedometer.

Resetting values



Example: resetting "From Start" trip computer (color multifunction display)

You can reset the values of the following functions:

- Trip odometer
 - "From Start" trip computer
 - "From Reset" trip computer
 - ECO display
 - ▶ Press the ◀ or ▶ button on the steering wheel to select the **Trip** menu.
 - ▶ Press the ▲ or ▼ button to select the function that you wish to reset.
 - ▶ Press the **OK** button.
 - ▶ Press the ▼ button to select **Yes** and press **OK** to confirm.
- i** When you reset the values in the "ECO display", the values in the trip computer "From Start" are likewise reset. When you

reset the values in the trip computer "From Start", the values in the "ECO display" are likewise reset.

Navigation system menu

Displaying navigation instructions

- ▶ Switch on the audio system or COMAND; see the separate operating instructions.
- ▶ Press the ◀ or ▶ button on the steering wheel to select the **Navi** menu.

In the **Navi** menu, the multifunction display shows navigation instructions. For more information, see the separate operating instructions.

Route guidance not active



Example: route guidance inactive (color multifunction display)

- ① Direction of travel
- ② Current road

Route guidance active

No change of direction announced



Example: no change of direction announced (color multifunction display)

- ① Distance to the destination
- ② Distance to the next change of direction

- ③ Current road
- ④ "Follow the road's course" symbol

Change of direction announced without a lane recommendation



Example: change of direction announced without lane recommendation (color multifunction display)

- ① Road into which the change of direction leads
- ② Distance to change of direction and visual distance display
- ③ Change-of-direction symbol

When a change of direction is announced, you will see symbol ③ for the change of direction and distance graphic ②. The distance indicator shortens towards the top of the display as you approach the point of the announced change of direction.

Change of direction announced with a lane recommendation



Example: change of direction announced with lane recommendation (color multifunction display)

- ① Road into which the change of direction leads
- ② Distance to change of direction and visual distance display
- ③ New lane during a change of direction
- ④ Uninterrupted lane
- ⑤ Lane recommendation
- ⑥ Change-of-direction symbol

On multilane roads, the system can display lane recommendation ③ for the next change of direction. During the change of direction, additional lanes may be displayed.

Lane recommendations are only displayed if the relevant data is available on the digital map.

Other status indicators of the navigation system

- : you have reached the destination or an intermediate destination.
- **New Route...** or **Calculating Route:** calculating a new route
- **Off Map** or **Off Mapped Road:** the vehicle position is outside the area of the digital map (off-map position).
- **No Route:** no route could be calculated to the selected destination.



Audio menu

Selecting a radio station





Example: radio station (color display)

- ① Waveband
 - ② Station frequency with memory position
- ❗ The memory position is only displayed along with station ② if this has been stored.
- ▶ Switch on the audio system or COMAND and select Radio; see the separate operating instructions.
 - ▶ Press the or button on the steering wheel to select the **Audio** menu.
 - ▶ **To select a stored station:** briefly press the or button.

- ▶ **To select a station from the station list:** press and briefly hold the  or  button.

If no station list is received:

- ▶ **To select a station using the station search:** press and briefly hold the  or  button.

i For information on changing waveband and storing stations, see the separate operating instructions.

i SIRIUS XM satellite radio functions like a normal radio.

For more information on satellite radio operation, see the separate operating instructions.



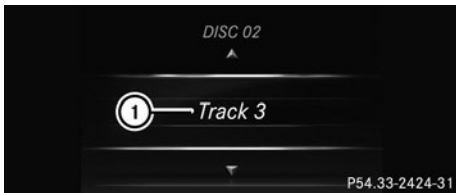



Operating an audio player or audio media





Example: CD/DVD changer display (color multifunction display)

① Current title

Audio data from various audio devices or media can be played, depending on the equipment installed in the vehicle.

- ▶ Switch on the audio system or COMAND and activate audio CD/DVD mode or MP3 mode; see the separate operating instructions.
- ▶ Press the  or  button on the steering wheel to select the **Audio** menu.
- ▶ **To select the next/previous track:** briefly press the  or  button.
- ▶ **To select a track from the track list (rapid scrolling):** press and hold the  or  button until desired track ① has been reached.

If you press and hold  or , the rapid scrolling speed is increased. Not all audio drives or data carriers support this function.







If track information is stored on the audio device or medium, the multifunction display will show the number and title of the track. The current track does not appear in audio AUX mode (**A**uxiliary audio mode: external audio source connected).

Video DVD operation



Example: CD/DVD changer display (color multifunction display)

① Current scene

- ▶ Switch on COMAND and select video DVD; see the separate operating instructions.
- ▶ Press the  or  button on the steering wheel to select the **Audio** menu.
- ▶ **To select the next/previous scene:** briefly press the  or  button.
- ▶ **To select a scene from the scene list (rapid scrolling):** press and hold the  or  button until desired scene has been reached.

Telephone menu



Introduction

WARNING

If you operate information systems and communication equipment integrated in the vehicle while driving, you will be distracted from traffic conditions. You could also lose control of the vehicle. There is a risk of an accident.

Only operate the equipment when the traffic situation permits. If you are not sure that this is possible, park the vehicle paying attention to traffic conditions and operate the equipment when the vehicle is stationary.

When telephoning, you must observe the legal requirements for the country in which you are currently driving.

- ▶ Switch on your mobile phone and audio system or COMAND, see the separate operating instructions.
- ▶ Establish a Bluetooth® connection to the audio system or COMAND; see the separate operating instructions.
- ▶ Press the  or  button on the steering wheel to select the **Te1** menu.

You will see one of the following display messages in the multifunction display:

- **Phone READY** or the name of the network provider: the mobile phone has found a network and is ready to receive.
- **Telephone No Service**: there is no network available or the mobile phone is searching for a network.

Accepting a call

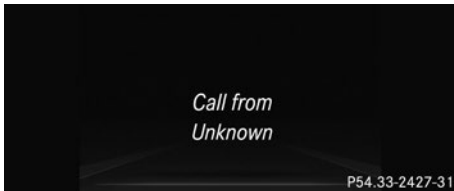

Example: incoming call (color multifunction display)

- ▶ Press the  button on the steering wheel to accept an incoming call.

If someone calls you when you are in the **Te1** menu, a display message appears in the multifunction display.









If you are not in the **Te1** menu, you can still accept a call.

Rejecting or ending a call



- ▶ Press the  button on the steering wheel.

If you are not in the **Te1** menu, you can still reject or end a call.







Dialing an entry from the phone book

- ▶ Press the  or  button on the steering wheel to select the **Te1** menu.
- ▶ Press the ,  or  button to switch to the phone book.
- ▶ Press the  or  button to select the desired name.
To start scrolling rapidly, press and hold the  or  button for longer than one second.



Rapid scrolling stops when you release the button or reach the end of the list.

- ▶ **If only one telephone number is stored for a name:** press the  or  button to start dialing.

or





- ▶ **If there is more than one number for a particular name:** press the  or  button to display the numbers.
- ▶ Press the ,  button to select the number you want to dial.
- ▶ Press the  or  button to start dialing.

or

- ▶ **If you do not want to make a call:** press the  or  button.

Redialing

The on-board computer saves the last names or numbers dialed in the redial memory.

- ▶ Press the  or  button on the steering wheel to select the **Te1** menu.
- ▶ Press the  button to switch to the redial memory.
- ▶ Press the  or  button to select the desired name or number.

- ▶ Press the  or  button to start dialing.
- or
- ▶ **If you do not want to make a call:** press the  or  button.

Assistance menu

Introduction



Menu view assistance (example: color multifunction display)





In the **DriveAssist** menu, you have the following options:

- Only vehicles with black and white multifunction display: show status overview
- Only vehicles with black and white multifunction display: show distance display
- Only vehicles with color multifunction display: show assistance graphic
- Activating/deactivating ESP®
- Activating/deactivating the distance warning function
- Activating/deactivating COLLISION PREVENTION ASSIST PLUS
- Activating/deactivating ATTENTION ASSIST
- Activating/deactivating Blind Spot Assist
- Activating/deactivating Lane Keeping Assist





Status overview

The **Status Overview** is only available in vehicles with color multifunction displays.

The status overview shows the status of driving systems or driving safety systems.





- ▶ Press the  or  button on the steering wheel to select the **DriveAssist** menu.
- ▶ Press  or  to select **Status Overview**.
- ▶ Press the  button.

The multifunction display shows:

- the  symbol, when the rear window wiper (▷ page 118) is activated.
- the  symbol, when ATTENTION ASSIST (▷ page 183) is activated.
- the  symbol, when the Lane Keeping Assist is activated.
- the  symbol when the distance warning function (▷ page 64) is activated.
- the  symbol when COLLISION PREVENTION ASSIST PLUS (▷ page 66) is activated.





Distance display

The **Distance Display** is only available in vehicles with a black and white multifunction display and DISTRONIC PLUS.

- ▶ Press the  or  button on the steering wheel to select the **DriveAssist** menu.
- ▶ Press the  or  button to select **Distance Display**.
- ▶ Press the  button.
The DISTRONIC PLUS distance display appears in the multifunction display (▷ page 168).





Assistance graphic

The **Assistance Graphic** is only available in vehicles with color multifunction displays.

- ▶ Press the  or  button on the steering wheel to select the **DriveAssist** menu.
- ▶ Press the  or  button to select **Assistance Graphic**.
- ▶ Press the  button.
The multifunction display shows the DISTRONIC PLUS distance display in the assistance graphic (▷ page 168).

The assistance graphic can display the status of and information from other driving systems or driving safety systems.

The assistance graphic shows:

- the  symbol, when the rear window wiper (▷ page 118) is activated.
- the  symbol when ATTENTION ASSIST (▷ page 183) is deactivated.
- the lane markings as bright lines when Lane Keeping Assist (▷ page 186) is activated.
- the  symbol when the distance warning function (▷ page 64) is deactivated.
- the  symbol when COLLISION PREVENTION ASSIST PLUS (▷ page 66) is deactivated.

Deactivating/activating ESP®

- ❗ Observe the "Important safety notes" section in the description of ESP (▷ page 68).

WARNING







If you deactivate ESP®, ESP® no longer stabilizes the vehicle. There is an increased risk of skidding and an accident.

Only deactivate ESP® in the situations described in the following.



It may be best to deactivate ESP® in the following situations:

- when using snow chains
- in deep snow
- on sand or gravel

For further information about ESP®, see (▷ page 67).

- ▶ Start the engine.
- ▶ Press the  or  button on the steering wheel to select the **DriveAssist** menu.
- ▶ Press the  or  button to select **ESP**.
- ▶ Press the  button.
The current selection is displayed.
- ▶ **To activate/deactivate:** press the  button again.







ESP® is deactivated if the  warning lamp in the instrument cluster lights up continuously when the engine is running.

If the  warning lamp and the  warning lamp are lit continuously, ESP® is not available due to a malfunction.

Observe the information on warning lamps (▷ page 241).

Observe the information on display messages (▷ page 208).

Switching the distance warning function on and off

- ▶ Press the  or  button on the steering wheel to select the **DriveAssist** menu.
- ▶ Press the  or  button to select **Distance Warning**.
- ▶ Press the  button.
The current selection is displayed.
- ▶ **To activate/deactivate:** press the  button again.







Vehicles with black and white multifunction display: when the distance warning function is activated, the multifunction display shows the  symbol in the status overview.

Vehicles with color multifunction display: when the distance warning function is deactivated, the  symbol appears in

the multifunction display in the assistance graphics display.

Further information on the distance warning function (▷ page 64).

Activating/deactivating COLLISION PREVENTION ASSIST PLUS







- ▶ Press the  or  button on the steering wheel to select the **DriveAssist** menu.
- ▶ Press the  or  button to select **Collision Prevent. Assist**.
- ▶ Press the  button.
The current selection is displayed.
- ▶ **To activate/deactivate:** press the  button again.

Vehicles with black and white multifunction display: when COLLISION PREVENTION ASSIST PLUS is activated, the multifunction display in the status overview shows the  symbol.

Vehicles with color multifunction display: when COLLISION PREVENTION ASSIST PLUS is deactivated, the multifunction display shows the  symbol in the assistance graphic.

For further information about COLLISION PREVENTION ASSIST PLUS, see (▷ page 66).

Activating/deactivating ATTENTION ASSIST







- ▶ Press the  or  button on the steering wheel to select the **DriveAssist** menu.
- ▶ Press the  or  button to select **Attention Assist**.
- ▶ Press the  button.
The current selection is displayed.
- ▶ **To activate/deactivate:** press the  button again.

Vehicles with black and white multifunction display: when Lane Keeping Assist is activated, the multifunction display in the status overview shows the  symbol.

Vehicles with color multifunction display: when Lane Keeping Assist is deactivated, the multifunction display shows the  symbol in the assistance graphic.

For further information about ATTENTION ASSIST, see (▷ page 183).

Activating/deactivating Blind Spot Assist











- ▶ Press the  or  button on the steering wheel to select the **DriveAssist** menu.
- ▶ Press the  or  button to select **Blind Spot Assist**.
- ▶ Press the  button.
The current selection is displayed.
- ▶ **To activate/deactivate:** press the  button again.

For further information about Blind Spot Assist, see (▷ page 184).

When the **Blind Spot Assist: Sensors Deactivated** message is shown, the radar sensors are deactivated.

- ▶ Switch on the radar sensor system (▷ page 205).

Activating/deactivating Lane Keeping Assist

- ▶ Press the  or  button on the steering wheel to select the **DriveAssist** menu.
- ▶ Press  or  to select **Lane Keeping Assist**.
- ▶ Press the  button.
The current selection is displayed.
- ▶ Press  to confirm.
- ▶ Press the  or  button to set **Off**, **Standard** or **Adaptive**.
- ▶ Press the  button to save the setting.
Vehicles with black and white multifunction display: when Lane Keeping Assist is activated, the multifunction display in the status overview shows the  symbol.

Vehicles with color multifunction display: when Lane Keeping Assist is activated, the multifunction display shows the lane markings as bright lines in the assistance graphic.

For further information about Lane Keeping Assist, see (▷ page 186).

Maintenance menu



Example: menu view assistance (color multifunction display)

In the **Serv** menu, you have the following options:

- Calling up display messages in message memory (▷ page 207)
- Restarting the tire pressure loss warning system (▷ page 319)
- Calling up the service due date (▷ page 284)

Settings menu

Introduction



Example: menu view settings (color multifunction display)

In the **Sett.** menu, you have the following options:

- Changing the instrument cluster settings
- Changing the light settings
- Changing the vehicle settings

- Changing the convenience settings
- Restoring the factory settings

Instrument cluster

Selecting the unit of measurement for distance

You can determine whether the multifunction display shows some messages in miles or kilometers.









- ▶ Press the or button on the steering wheel to select the **Sett.** menu.
- ▶ Press the or button to select the **Instrument Cluster** submenu.
- ▶ Press to confirm.
- ▶ Press the or button to select the **Display Unit Speed-/Odometer:** function.
You will see the selected setting **km** or **miles**.
- ▶ Press the button to save the setting.

The selected unit of measurement for distance applies to:

- the digital speedometer in the **Trip** menu
- the odometer and the trip odometer
- the trip computer
- the current consumption and the range
- navigation instructions in the **Navi** menu
- cruise control
- DISTRONIC PLUS
- ASSYST PLUS service interval display









Switching the additional speedometer on/off

The **Additional Speedometer [km/h]**: or **Additional Speedometer [mph]**: function allows you to choose whether the status area in the multifunction display always shows the speed in **km/h** or in **mph** instead of the outside temperature.

- ▶ Press the  or  button on the steering wheel to select the **Sett.** menu.
- ▶ Press the  or  button to select the **Instrument Cluster** submenu.
- ▶ Press  to confirm.
- ▶ Press  or  to select the **Additional Speedometer [km/h]:** or **Additional Speedometer [mph]:** function.
You will see the selected setting: **On** or **Off**.
- ▶ Press the  button to save the setting.

Selecting the permanent display function

You can determine whether the multifunction display permanently shows your speed or the outside temperature.





- ▶ Press the  or  button on the steering wheel to select the **Sett.** menu.
- ▶ Press the  or  button to select the **Instrument Cluster** submenu.
- ▶ Press  to confirm.
- ▶ Press the  or  button to select the **Permanent Display:** function.
You will see the selected setting **Outside Temperature** or **Additional Speedometer [mph]/Additional Speedometer [mph]**.
- ▶ Press the  button to save the setting.





 The speed is displayed in km/h/mpH.

Lights

Switching the daytime running lamps on/off

Canada only: daytime running lamps are required by law. You cannot set the **Daytime Driving Lights** function via the on-board computer.









- ▶ Press the  or  button on the steering wheel to select the **Sett.** menu.
- ▶ Press the  or  button to select the **Lights** submenu.

- ▶ Press  to confirm.
- ▶ Press the  or  button to select the **Daytime Running Lights** function.
Vehicles with black and white multifunction display: you will see the selected setting: **On** or **Off**.
Vehicles with color multifunction display: if the **Daytime Running Lights** function has been switched on, the cone of light and the  symbol in the multifunction display are shown in orange.
- ▶ Press the  button to save the setting.

Further information on daytime running lamps (▷ page 105).













Switching Adaptive Highbeam Assist on/off

This function is only available on vehicles with the Intelligent Light System.

- ▶ Press the  or  button on the steering wheel to select the **Sett.** menu.
- ▶ Press the  or  button to select the **Lights** submenu.
- ▶ Press  to confirm.
- ▶ Press  or  to select the **Adaptive Highbeam Assist** (vehicles with black and white display) or **Adaptive Highbeam** (vehicles with color multifunction display) function.
Vehicles with black and white multifunction display: you will see the selected setting: **On** or **Off**.
Vehicles with color multifunction display: if the **Adaptive Highbeam** function has been switched on, the cone of light and the  symbol in the multifunction display are shown in orange.
- ▶ Press the  button to save the setting.





For further information about Adaptive Highbeam Assist, see (▷ page 108).



Setting the brightness of the ambient lighting

- ▶ Press the  or  button on the steering wheel to select the **Sett.** menu.
- ▶ Press the  or  button to select the **Lights** submenu.
- ▶ Press  to confirm.
- ▶ Press  or  to select the **Ambient Light Brightness:** (vehicles with black and white display) or **Amb. Light +/-** (vehicles with color multifunction display) function.
You will see the selected setting.
- ▶ Press  to confirm.
- ▶ Press the  or  button to adjust the brightness to any level from **Off** to **Level 5** (bright).
- ▶ Press the  or  button to save the setting.

Activating/deactivating surround lighting and exterior lighting delayed switch-off

If you have activated the **Surround Lighting** function and the light switch is set to **AUTO**, the following functions are activated when it is dark:

- **surround lighting:** the exterior lighting remains lit for 40 seconds after unlocking with the key. If you start the engine, the surround lighting is switched off and automatic headlamp mode is activated (▷ page 105).
 - **exterior lighting delayed switch-off:** the exterior lighting remains lit for 60 seconds after the engine is switched off. If you close all the doors and the tailgate, the exterior lighting goes off after 15 seconds.
- ▶ Press the  or  button on the steering wheel to select the **Sett.** menu.
 - ▶ Press the  or  button to select the **Lights** submenu.
 - ▶ Press  to confirm.

- ▶ Press the  or  button to select the **Surround Lighting** function.
Vehicles with black and white multifunction display: you will see the selected setting: **On** or **Off**.
Vehicles with color multifunction display: if the **Surround Lighting** function is switched on, the light cone and the area around the vehicle are displayed in orange in the multifunction display.
- ▶ Press the  button to save the setting.

Deactivating delayed switch-off of the exterior lighting temporarily:

- ▶ Before leaving the vehicle, turn the SmartKey to position **0** in the ignition lock.
- ▶ Turn the SmartKey to position **2** in the ignition lock.
The exterior lighting delayed switch-off is deactivated.





Delayed switch-off of the exterior lighting is reactivated the next time you start the engine.

i Depending on your vehicle's equipment, when the surround lighting and delayed switch-off exterior lighting are on, the following light up:

- Parking lamps
- Front fog lamps
- Low-beam headlamps
- Daytime running lamps
- Side marker lamps
- Surround lighting in the exterior mirrors

Activating/deactivating the interior lighting delayed switch-off

If you activate the **Interior Lighting Delay** function, the interior lighting remains on for 20 seconds after you remove the key from the ignition lock.

- ▶ Press the  or  button on the steering wheel to select the **Sett.** menu.
- ▶ Press the  or  button to select the **Lights** submenu.

- ▶ Press **OK** to confirm.
- ▶ Press the **▼** or **▲** button to select the **Interior Lighting Delay** function.
Vehicles with black and white multifunction display: you will see the selected setting: **On** or **Off**.
If the **Interior Lighting Delay** function has been switched on, the vehicle interior is displayed in orange in the multifunction display.
- ▶ Press the **OK** button to save the setting.

Vehicle

Activating/deactivating the automatic door locking mechanism

- ▶ Press the **◀** or **▶** button on the steering wheel to select the **Sett.** menu.
- ▶ Press the **▼** or **▲** button to select the **Vehicle** submenu.
- ▶ Press **OK** to confirm.
- ▶ Press **▼** or **▲** to select the **Automatic Door Lock** (vehicles with black and white multifunction display) or **Automatic Door Lock** (vehicles with color multifunction display) function.
Vehicles with black and white multifunction display: you will see the selected setting: **on** or **off**.
Vehicles with color multifunction display: when the **Automatic Door Lock** function is activated, the vehicle doors are displayed in orange in the multifunction display.
- ▶ Press the **OK** button to save the setting.

If you select the **Automatic Door Lock** (vehicles with black and white multifunction display) or **Automatic Door Lock** (vehicles with color multifunction display) function, the vehicle is centrally locked above a speed of approximately 9 mph (15 km/h).

For further information on the automatic locking feature, see (▶ page 80).

Activating/deactivating the acoustic locking verification signal

If you switch on the **Acoustic Lock Feedback** (vehicles with black and white multifunction display) or **Acoustic Lock** (vehicles with color multifunction display) function, an acoustic signal sounds when you lock the vehicle.

- ▶ Press the **◀** or **▶** button on the steering wheel to select the **Sett.** menu.
- ▶ Press the **▼** or **▲** button to select the **Vehicle** submenu.
- ▶ Press **OK** to confirm.
- ▶ Press **▼** or **▲** to select the **Acoustic Lock Feedback** (vehicles with black and white display) or **Acoustic Lock** (vehicles with color multifunction display) function.
Vehicles with black and white multifunction display: you will see the selected setting: **On** or **Off**.
Vehicles with color multifunction display: if the **Acoustic Lock** function is activated, the **🔒** symbol in the multifunction display lights up orange.
- ▶ Press the **OK** button to save the setting.

Activating/deactivating the radar sensor system

- ▶ Press the **◀** or **▶** button on the steering wheel to select the **Settings** menu.
- ▶ Press the **▼** or **▲** button to select the **Vehicle** submenu.
- ▶ Press **OK** to confirm.
- ▶ Press the **▲** or **▼** button to select **Radar Sensors (See Oper. Manual)**.
You will see the selected setting **On** or **Off**.
- ▶ Press the **OK** button to save the setting.

If the radar sensor system is switched off, Blind Spot Assist is deactivated (▶ page 184).

Convenience







Switching the fold-in mirrors with the locking feature on/off

This function is only available on vehicles with the memory function (▷ page 101).

If you switch on the **Fold Mirrors in when Locking** (vehicles with black and white multifunction display) or **Auto. Mirror Folding** function (vehicles with color multifunction display), the exterior mirrors fold in when you lock the vehicle.

If you unlock the vehicle and then open a door, the exterior mirrors fold out again.









If you have switched on the **Fold Mirrors in when Locking** (vehicles with black and white multifunction display) or **Auto. Mirror Folding** (vehicles with color multifunction display) function and you fold in the exterior mirrors using the button on the door (▷ page 99), they will not fold out automatically. The exterior mirrors can then only be folded out using the button on the door.

- ▶ Press the  or  button on the steering wheel to select the **Sett.** menu.
- ▶ Press the  or  button to select the **Convenience** submenu.
- ▶ Press  to confirm.
- ▶ Press  or  to select the **Fold Mirrors in when Locking** (vehicles with black and white multifunction display) or **Auto. Mirror Folding** (vehicles with color multifunction display) function. Vehicles with black and white multifunction display: you will see the selected setting: **On** or **Off**.

Vehicles with color multifunction display: if the **Auto. Mirror Folding** function is activated, the vehicle's exterior mirror is displayed in orange in the multifunction display.

- ▶ Press the  button to save the setting.

Restoring the factory settings

- ▶ Press the  or  button on the steering wheel to select the **Sett.** menu.
- ▶ Press the  or  button to select the **Factory Setting** submenu.
- ▶ Press  to confirm. The **Reset All Settings?** message appears.
- ▶ Press the  or  button to select **No** or **Yes**.
- ▶ Press  to confirm the selection. If you have selected **Yes**, the multifunction display shows a confirmation message.

For safety reasons, the **Daytime Running Lights** function in the **Lights** submenu is only reset if the vehicle is stationary.

Display messages

General notes

Display messages appear in the multifunction display.

Display messages with graphic displays may be shown in simplified form in the Operator's Manual and may differ from the messages shown in the multifunction display.



Please respond in accordance with the display messages and follow the additional notes in this Operator's Manual.

Certain display messages are accompanied by an audible warning tone or a continuous tone.

When the ignition is switched off, all display messages are deleted, apart from some high-priority display messages. Once the causes of the high-priority display messages have been rectified, the corresponding display messages are also deleted.

When you stop and park the vehicle, please observe the notes on the HOLD function (> page 171) and parking (> page 152).

Hiding display messages







- ▶ Press the  or  button on the steering wheel to hide the display message. The display message is cleared.

The multifunction display shows high-priority display messages in red. Some high-priority display messages cannot be hidden.

The multifunction display shows these messages continuously until the causes for the messages have been remedied.

Message memory

The on-board computer saves certain display messages in the **message memory**. You can call up the display messages:

- ▶ Press  or  on the steering wheel to select the **Serv** menu. If there are display messages, the multifunction display shows, for example, **2 Messages**.
- ▶ Press the  or  button to select the entry, e.g. **2 Messages**.
- ▶ Press  to confirm.
- ▶ Press the  or  button to scroll through the display messages.

Safety systems

Display messages





Currently
Unavailable See
Operator's Manual

Possible causes/consequences and ► Solutions

ABS (Anti-lock Braking System), ESP[®] (Electronic Stability Program), BAS (Brake Assist), the HOLD function and hill start assist are temporarily unavailable.

COLLISION PREVENTION ASSIST/COLLISION PREVENTION ASSIST PLUS may also have failed.

In addition, the ,  and  warning lamps light up in the instrument cluster.

ATTENTION ASSIST is deactivated.

Possible causes are:

- self-diagnosis is not yet complete.
- the on-board voltage may be insufficient.

 **WARNING**

The brake system continues to function normally, but without the functions listed above. The wheels could therefore lock if you brake hard, for example.

The steerability and braking characteristics may be severely affected. The braking distance in an emergency braking situation can increase.

If ESP[®] is not operational, ESP[®] is unable to stabilize the vehicle. There is an increased risk of skidding and an accident.

► Carefully drive a short distance on a suitable stretch of road, making slight steering movements at a speed above 12 mph (20 km/h).

If the display message disappears, the functions mentioned above are available again.

If the display message continues to be displayed:





- Drive on carefully.
- Visit a qualified specialist workshop.



Inoperative See
Operator's Manual





ABS, ESP[®], BAS, the HOLD function and hill start assist are unavailable due to a malfunction.









COLLISION PREVENTION ASSIST/COLLISION PREVENTION ASSIST PLUS may also have failed.







In addition, the , ,  and  warning lamps light up in the instrument cluster.









ATTENTION ASSIST is deactivated.















 **WARNING**







Display messages	Possible causes/consequences and ► Solutions
	<p>The brake system continues to function normally, but without the functions listed above. The wheels could therefore lock if you brake hard, for example.</p> <p>The steerability and braking characteristics may be severely affected. The braking distance in an emergency braking situation can increase.</p> <p>If ESP® is not operational, ESP® is unable to stabilize the vehicle. There is an increased risk of skidding and an accident.</p> <ul style="list-style-type: none"> ► Drive on carefully. ► Visit a qualified specialist workshop immediately.
<div style="border: 1px solid black; padding: 2px; width: fit-content; margin-bottom: 5px;">  </div> <p>Currently Unavailable See Operator's Manual</p>	<p>ESP®, BAS, the HOLD function and hill start assist are temporarily unavailable.</p> <p>COLLISION PREVENTION ASSIST/COLLISION PREVENTION ASSIST PLUS may also have failed.</p> <p>In addition, the  and  warning lamps light up in the instrument cluster.</p> <p>ATTENTION ASSIST is deactivated.</p> <p>The self-diagnosis function might not be complete, for example.</p> <p> WARNING</p> <p>The brake system continues to function normally, but without the functions listed above.</p> <p>The braking distance in an emergency braking situation can thus increase.</p> <p>If ESP® is not operational, ESP® is unable to stabilize the vehicle. There is an increased risk of skidding and an accident.</p> <ul style="list-style-type: none"> ► Carefully drive a short distance on a suitable stretch of road, making slight steering movements at a speed above 12 mph (20 km/h). <p>If the display message disappears, the functions mentioned above are available again.</p> <p>If the display message continues to be displayed:</p> <ul style="list-style-type: none"> ► Drive on carefully. ► Visit a qualified specialist workshop.

Display messages	Possible causes/consequences and ► Solutions
 <p data-bbox="181 326 398 383">Inoperative See Operator's Manual</p>	<p data-bbox="438 275 1100 333">ESP®, BAS, the HOLD function and hill start assist are unavailable due to a malfunction.</p> <p data-bbox="438 342 1047 399">COLLISION PREVENTION ASSIST/COLLISION PREVENTION ASSIST PLUS may also have failed.</p> <p data-bbox="438 408 1058 465">In addition, the  and  warning lamps light up in the instrument cluster.</p> <p data-bbox="438 474 793 499">ATTENTION ASSIST is deactivated.</p> <p data-bbox="448 516 602 544">▲ WARNING</p> <p data-bbox="438 557 1100 614">The brake system continues to function normally, but without the functions listed above.</p> <p data-bbox="438 623 1100 680">The braking distance in an emergency braking situation can thus increase.</p> <p data-bbox="438 689 1100 747">If ESP® is not operational, ESP® is unable to stabilize the vehicle. There is an increased risk of skidding and an accident.</p> <ul data-bbox="438 759 834 820" style="list-style-type: none"> ► Drive on carefully. ► Visit a qualified specialist workshop.
   <p data-bbox="181 946 398 1003">Inoperative See Operator's Manual</p>	<p data-bbox="438 851 1073 937">EBD (electronic brake force distribution), ABS, ESP®, BAS, the HOLD function and hill start assist are not available due to a malfunction.</p> <p data-bbox="438 946 1047 1003">COLLISION PREVENTION ASSIST/COLLISION PREVENTION ASSIST PLUS may also have failed.</p> <p data-bbox="438 1012 1084 1069">In addition, the ,  and  warning lamps light up in the instrument cluster and a warning tone sounds.</p> <p data-bbox="438 1078 793 1103">ATTENTION ASSIST is deactivated.</p> <p data-bbox="448 1120 602 1148">▲ WARNING</p> <p data-bbox="438 1161 1100 1247">The brake system continues to function normally, but without the functions listed above. The front and rear wheels could therefore lock if you brake hard, for example.</p> <p data-bbox="438 1256 1100 1342">The steerability and braking characteristics may be severely affected. The braking distance in an emergency braking situation can increase.</p> <p data-bbox="438 1351 1100 1408">If ESP® is not operational, ESP® is unable to stabilize the vehicle. There is an increased risk of skidding and an accident.</p> <ul data-bbox="438 1421 965 1481" style="list-style-type: none"> ► Drive on carefully. ► Visit a qualified specialist workshop immediately.



Display messages	Possible causes/consequences and ► Solutions
<p>PARK (USA only)  (Canada only)</p> <p>Please Release Parking Brake</p>	<p>The red PARK (USA only) /  (Canada only) indicator lamp flashes and a warning tone sounds. A condition for automatic release of the electric parking brake is not fulfilled (► page 153). You are driving with the electric parking brake applied.</p> <ul style="list-style-type: none"> ► Release the electric parking brake manually. <p>The red PARK (USA only) /  (Canada only) indicator lamp flashes and a warning tone sounds. You are making an emergency stop using the electric parking brake (► page 153).</p>
<p>PARK (USA only)  (Canada only)</p> <p>Parking Brake See Operator's Manual</p>	<p>The yellow  warning lamp lights up. The electric parking brake is malfunctioning.</p> <p>To apply:</p> <ul style="list-style-type: none"> ► Switch the ignition off. ► Press the electric parking brake handle for at least ten seconds. ► Shift the transmission to P. ► Consult a qualified specialist workshop. <p>The yellow  warning lamp and the red PARK (USA only) /  (Canada only) indicator lamp light up. The electric parking brake is malfunctioning.</p> <p>To release:</p> <ul style="list-style-type: none"> ► Switch off the ignition and turn it back on. ► Release the electric parking brake manually. <p>or</p> <ul style="list-style-type: none"> ► Release the electric parking brake automatically (► page 153). <p>If the electric parking brake still cannot be released:</p> <ul style="list-style-type: none"> ► Do not drive on. ► Consult a qualified specialist workshop.













Display messages	Possible causes/consequences and ► Solutions
	<p>The red  (USA only)/ (Canada only) indicator lamp flashes and the yellow  warning lamp lights up. The electric parking brake is malfunctioning.</p> <p>To release:</p> <ul style="list-style-type: none"> ► Switch off the ignition and turn it back on. ► Release the electric parking brake manually. <p>To apply:</p> <ul style="list-style-type: none"> ► Switch off the ignition and turn it back on. ► Apply the electric parking brake manually. <p>If the red  (USA only)/ (Canada only) indicator lamp continues to flash:</p> <ul style="list-style-type: none"> ► Do not drive on. ► Secure the vehicle against rolling away (▷ page 337). ► Shift the transmission to P. ► Turn the front wheels towards the curb. ► Consult a qualified specialist workshop.
	<p>The yellow  warning lamp lights up. The red  (USA only)/ (Canada only) indicator lamp flashes for about ten seconds after the electric parking brake has been applied or released. It then goes out or remains lit. The electric parking brake is malfunctioning.</p> <ul style="list-style-type: none"> ► Switch off the ignition and turn it back on. ► Apply the electric parking brake. <p>If it is not possible to engage the electric parking brake:</p> <ul style="list-style-type: none"> ► Shift the transmission to P. ► Visit a qualified specialist workshop. <p>If it is not possible to release the electric parking brake:</p> <ul style="list-style-type: none"> ► Release the electric parking brake automatically (▷ page 153). <p>If the electric parking brake still cannot be released:</p> <ul style="list-style-type: none"> ► Consult a qualified specialist workshop.

Display messages	Possible causes/consequences and ► Solutions
	<p>The yellow  warning lamp lights up. If you manually apply or release the electric parking brake, the red  (USA only)/  (Canada only) indicator lamp flashes.</p> <p>The electric parking brake is malfunctioning. It is not possible to apply the electric parking brake manually.</p> <ul style="list-style-type: none"> ► Shift the transmission to P. ► Visit a qualified specialist workshop.
<p> (USA only)  (Canada only)</p> <p>Parking Brake Inoperative</p>	<p>The yellow  warning lamp lights up. The red  (USA only)/  (Canada only) indicator lamp flashes for about ten seconds after the electric parking brake has been applied or released. It then goes out or remains lit.</p> <p>The electric parking brake is malfunctioning, e.g. because of overvoltage or undervoltage.</p> <ul style="list-style-type: none"> ► Remove the cause for the overvoltage or undervoltage, e.g. by charging the battery or restarting the engine. ► Engage or release the electric parking brake. <p>If it remains impossible to apply or release the electric parking brake:</p> <ul style="list-style-type: none"> ► Switch off the ignition and turn it back on. ► Engage or release the electric parking brake. <p>If the electric parking brake still cannot be released:</p> <ul style="list-style-type: none"> ► Consult a qualified specialist workshop. <p>The display message is only shown while the vehicle is in motion. The yellow  warning lamp lights up and the red  (USA only)/  (Canada only) indicator lamp flashes.</p> <p>It is not possible to apply the electric parking brake manually.</p> <ul style="list-style-type: none"> ► Shift the transmission to P. ► Visit a qualified specialist workshop.
<p> (USA only)  (Canada only)</p> <p>Turn On the Ignition to Release the Parking Brake</p>	<p>The red  (USA only)/  (Canada only) indicator lamp lights up.</p> <p>You attempted to release the electric parking brake while the ignition was switched off.</p> <ul style="list-style-type: none"> ► Turn the SmartKey to position 1 in the ignition lock.

Display messages	Possible causes/consequences and ► Solutions
<p> (USA only)  (Canada only)</p> <p>Check Brake Fluid Level</p>	<p>There is not enough brake fluid in the brake fluid reservoir. In addition, the  (USA only)/ (Canada only) warning lamp lights up in the instrument cluster and a warning tone sounds.</p> <p> WARNING</p> <p>The braking effect may be impaired. There is a risk of an accident.</p> <ul style="list-style-type: none"> ► Pull over and stop the vehicle safely as soon as possible, paying attention to road and traffic conditions. Do not continue driving under any circumstances. ► Secure the vehicle against rolling away (▷ page 152). ► Consult a qualified specialist workshop. ► Do not add brake fluid. This does not correct the malfunction.
<p></p> <p>Check Brake Pad Wear</p>	<p>The brake pads/linings have reached their wear limit.</p> <ul style="list-style-type: none"> ► Visit a qualified specialist workshop.
<p></p> <p>mbrace Inoperative</p>	<p>One or more main features of the mbrace system are malfunctioning.</p> <ul style="list-style-type: none"> ► Have the mbrace system checked immediately at a qualified specialist workshop.

Display messages	Possible causes/consequences and ► Solutions
<p>Collision Prevention Assist Plus Currently Unavailable See Operator's Manual</p>	<p>COLLISION PREVENTION ASSIST PLUS is temporarily not operational. Possible causes are:</p> <ul style="list-style-type: none"> • the front bumper is dirty. • function is impaired due to heavy rain or snow. • the radar sensor system is temporarily inoperative, e.g. due to electromagnetic radiation emitted by nearby TV or radio stations or other sources of electromagnetic radiation. • the system is outside the operating temperature range. • the on-board voltage is too low. <p>When the causes stated above no longer apply, the display message disappears.</p> <p>COLLISION PREVENTION ASSIST PLUS is operational again.</p> <p>If the display message does not disappear:</p> <ul style="list-style-type: none"> ► Pull over and stop the vehicle safely as soon as possible, paying attention to road and traffic conditions. ► Secure the vehicle against rolling away (▷ page 152). ► Clean the front bumper (▷ page 289). ► Restart the engine.
<p>Collision Prevention Assist Plus Inoperative</p>	<p>COLLISION PREVENTION ASSIST PLUS is malfunctioning. The distance warning signal may also have failed.</p> <ul style="list-style-type: none"> ► Visit a qualified specialist workshop.

Display messages	Possible causes/consequences and ► Solutions
<p>PRE-SAFE Functions Currently Limited See Owner's Manual</p>	<p>Adaptive Brake Assist is temporarily inoperative. Possible causes are:</p> <ul style="list-style-type: none"> • the front bumper is dirty. • function is impaired due to heavy rain or snow. • the radar sensor system is temporarily inoperative, e.g. due to electromagnetic radiation emitted by nearby TV or radio stations or other sources of electromagnetic radiation. • the system is outside the operating temperature range. • the on-board voltage is too low. <p>When the causes stated above no longer apply, the display message disappears.</p> <p>Adaptive Brake Assist is operational again.</p> <p>If the display message does not disappear:</p> <ul style="list-style-type: none"> ► Pull over and stop the vehicle safely as soon as possible, paying attention to road and traffic conditions. ► Secure the vehicle against rolling away (▷ page 152). ► Clean the front bumper (▷ page 289). ► Restart the engine.
<p>PRE-SAFE Functions Limited See Operator's Manual</p>	<p>Adaptive Brake Assist is faulty. The distance warning signal may also have failed.</p> <ul style="list-style-type: none"> ► Visit a qualified specialist workshop.
<p> SRS Malfunction Service Required</p>	<p>There is a malfunction in the SRS (Supplemental Restraint System). The  warning lamp also lights up in the instrument cluster.</p> <p>⚠ WARNING</p> <p>The air bags or Emergency Tensioning Devices may either be triggered unintentionally or, in the event of an accident, may not be triggered.</p> <p>There is an increased risk of injury.</p> <ul style="list-style-type: none"> ► Visit a qualified specialist workshop. <p>Further information on occupant safety (▷ page 40).</p>

Display messages	Possible causes/consequences and ► Solutions
 <p>Front Left Malfunction Service Required or Front Right Malfunction Service Required</p>	<p>SRS has malfunctioned at the front on the left or right. The  warning lamp also lights up in the instrument cluster.</p> <p> WARNING</p> <p>The air bags or Emergency Tensioning Devices may either be triggered unintentionally or, in the event of an accident, may not be triggered.</p> <p>There is an increased risk of injury.</p> <p>► Visit a qualified specialist workshop.</p>
 <p>Rear Left Malfunction Service Required or Rear Right Malfunction Service Required</p>	<p>SRS has malfunctioned at the rear on the left or right. The  warning lamp also lights up in the instrument cluster.</p> <p> WARNING</p> <p>The air bags or Emergency Tensioning Devices may either be triggered unintentionally or, in the event of an accident, may not be triggered.</p> <p>There is an increased risk of injury.</p> <p>► Visit a qualified specialist workshop.</p>
 <p>Rear Center Malfunction Service Required</p>	<p>SRS has malfunctioned at the rear center. The  warning lamp also lights up in the instrument cluster.</p> <p> WARNING</p> <p>The air bags or Emergency Tensioning Devices may either be triggered unintentionally or, in the event of an accident, may not be triggered.</p> <p>There is an increased risk of injury.</p> <p>► Visit a qualified specialist workshop.</p>
 <p>Left Side Curtain Airbag Malfunction Service Required or Right Side Curtain Airbag Malfunction Service Required</p>	<p>There is a malfunction in the left-hand or right-hand window curtain air bag. The  warning lamp also lights up in the instrument cluster.</p> <p> WARNING</p> <p>The left or right window curtain air bag may either be triggered unintentionally or, in the event of an accident, may not be triggered.</p> <p>There is an increased risk of injury.</p> <p>► Visit a qualified specialist workshop.</p>

Display messages

Front Passenger
Airbag Disabled
See Operator's
Manual

Possible causes/consequences and ► Solutions

The front-passenger air bag is disabled during the journey, even though:

- an adult
or
- a person larger than a certain size is occupying the front-passenger seat

If additional forces are applied to the seat, the system may interpret the occupant's weight as lower than it actually is.

 **WARNING**

The front-passenger air bag does not deploy during an accident. There is an increased risk of injury.

- Pull over and stop the vehicle safely as soon as possible, paying attention to road and traffic conditions.
- Secure the vehicle against rolling away (► page 152).
- Switch the ignition off.
- Have the occupant get out of the vehicle.
- Keep the seat unoccupied, close the front-passenger door and switch on the ignition.
- Observe the PASSENGER AIR BAG OFF indicator lamp in the center console and the multifunction display and check the following:

Seat unoccupied and ignition switched on:

- the PASSENGER AIR BAG OFF indicator lamp must light up and remain lit. If the indicator lamp is on, OCS has disabled the front-passenger air bag (► page 47).
- the [Front Passenger Airbag Enabled See Operator's Manual](#) or [Front Passenger Airbag Disabled See Operator's Manual](#) display messages must not be shown in the multifunction display.
- Wait for a period of at least 60 seconds until the necessary system checks have been completed.
- Make sure that the display messages do not appear in the multifunction display.

If these conditions are fulfilled, the front-passenger seat can be occupied again. Whether the PASSENGER AIR BAG OFF indicator lamp remains lit or goes out depends on how OCS classifies the occupant.

If the conditions are not fulfilled, the system is not operating correctly.

- Visit a qualified specialist workshop immediately.



Display messages	Possible causes/consequences and ► Solutions
	<p>For further information about the Occupant Classification System, see (▷ page 47).</p>
<p>Front Passenger Airbag Enabled See Operator's Manual</p>	<p>The front-passenger air bag is enabled during the journey, even though:</p> <ul style="list-style-type: none"> • a child, a small adult or an object weighing less than the system's weight threshold is located on the front-passenger seat or • the front-passenger seat is unoccupied <p>The system may detect objects or forces applying additional weight on the seat.</p> <p> WARNING</p> <p>The air bag may deploy unintentionally. There is an increased risk of injury.</p> <ul style="list-style-type: none"> ► Pull over and stop the vehicle safely as soon as possible, paying attention to road and traffic conditions. ► Secure the vehicle against rolling away (▷ page 152). ► Switch the ignition off. ► Open the front-passenger door. ► Remove the child and the child restraint system from the front-passenger seat. ► Make sure that there are no objects on the seat adding to the weight. <p>The system may otherwise detect the additional weight and interpret the seat occupant's weight as greater than it actually is.</p> <ul style="list-style-type: none"> ► Keep the seat unoccupied, close the front-passenger door and switch on the ignition. ► Observe the PASSENGER AIR BAG OFF indicator lamp in the center console and the multifunction display and check the following: <p>Seat unoccupied and ignition switched on:</p> <ul style="list-style-type: none"> • the PASSENGER AIR BAG OFF indicator lamp must light up and remain lit. If the indicator lamp is on, OCS (Occupant Classification System) has disabled the front-passenger air bag (▷ page 47). • the Front Passenger Airbag Enabled See Operator's Manual or Front Passenger Airbag Disabled See Operator's Manual display messages must not be shown in the multifunction display.







Display messages	Possible causes/consequences and ► Solutions
	<ul style="list-style-type: none"> ► Wait for a period of at least 60 seconds until the necessary system checks have been completed. ► Make sure that the display messages do not appear in the multifunction display. <p>If these conditions are fulfilled, the front-passenger seat can be occupied again. Whether the PASSENGER AIR BAG OFF indicator lamp remains lit or goes out depends on how OCS classifies the occupant.</p> <p>If the conditions are not fulfilled, the system is not operating correctly.</p> <ul style="list-style-type: none"> ► Visit a qualified specialist workshop immediately. <p>For further information about the Occupant Classification System, see (▷ page 47).</p>







Lights





i Display messages about LEDs:

This display message will only appear if all LEDs have failed.

Display messages	Possible causes/consequences and ► Solutions
 Check Left Cornering Light or Check Right Cornering Light	<p>The left or right-hand cornering light is defective.</p> <ul style="list-style-type: none"> ► Check whether you are permitted to replace the bulb yourself (▷ page 110). <p>or</p> <ul style="list-style-type: none"> ► Visit a qualified specialist workshop.
 Check Left Low Beam or Check Right Low Beam	<p>The left or right-hand low-beam headlamp is defective.</p> <ul style="list-style-type: none"> ► Check whether you are permitted to replace the bulb yourself (▷ page 110). <p>or</p> <ul style="list-style-type: none"> ► Visit a qualified specialist workshop.
 Check Rear Left Turn Signal or Check Rear Right Turn Signal	<p>The rear left-hand or rear right-hand turn signal is defective.</p> <ul style="list-style-type: none"> ► Check whether you are permitted to replace the bulb yourself (▷ page 110). <p>or</p> <ul style="list-style-type: none"> ► Visit a qualified specialist workshop.

Display messages	Possible causes/consequences and ► Solutions
 <p>Check Front Left Turn Signal or Check Front Right Turn Signal</p>	<p>The front left-hand or front right-hand turn signal is defective.</p> <ul style="list-style-type: none"> ► Check whether you are permitted to replace the bulb yourself (▷ page 110). <p>or</p> <ul style="list-style-type: none"> ► Visit a qualified specialist workshop.
 <p>Check Left Mirror Turn Signal or Check Right Mirror Turn Signal</p>	<p>The turn signal in the left-hand or right-hand exterior mirror is defective.</p> <ul style="list-style-type: none"> ► Visit a qualified specialist workshop.
 <p>Check Center Brake Lamp</p>	<p>The high-mounted brake lamp is faulty.</p> <ul style="list-style-type: none"> ► Visit a qualified specialist workshop.
 <p>Check Left Brake Lamp or Check Right Brake Lamp</p>	<p>The left or right-hand brake lamp is defective.</p> <ul style="list-style-type: none"> ► Check whether you are permitted to replace the bulb yourself (▷ page 110). <p>or</p> <ul style="list-style-type: none"> ► Visit a qualified specialist workshop.
 <p>Check Left Tail and Brake Lamps or Check Right Tail and Brake Lamps</p>	<p>The left or right-hand tail lamp/brake lamp is defective.</p> <ul style="list-style-type: none"> ► Check whether you are permitted to replace the bulb yourself (▷ page 110). <p>or</p> <ul style="list-style-type: none"> ► Visit a qualified specialist workshop.
 <p>Check Left High Beam or Check Right High Beam</p>	<p>The left or right-hand high beam is defective.</p> <ul style="list-style-type: none"> ► Check whether you are permitted to replace the bulb yourself (▷ page 110). <p>or</p> <ul style="list-style-type: none"> ► Visit a qualified specialist workshop.
 <p>License Plate Lamp</p>	<p>The left or right-hand license plate lamp is defective.</p> <ul style="list-style-type: none"> ► Check whether you are permitted to replace the bulb yourself (▷ page 110). <p>or</p> <ul style="list-style-type: none"> ► Visit a qualified specialist workshop.

Display messages	Possible causes/consequences and ► Solutions
 <p>Check Left Fog Lamp or Check Right Fog Lamp</p>	<p>The left-hand or right-hand front fog lamp is defective.</p> <p>► Visit a qualified specialist workshop.</p>
 <p>Rear Fog Lamp</p>	<p>The rear fog lamp is defective.</p> <p>► Check whether you are permitted to replace the bulb yourself (> page 110).</p> <p>or</p> <p>► Visit a qualified specialist workshop.</p>
 <p>Check Front Left Parking Lamp or Check Front Right Parking Lamp</p>	<p>The front left or front right parking or standing lamp is defective.</p> <p>► Check whether you are permitted to replace the bulb yourself (> page 110).</p> <p>or</p> <p>► Visit a qualified specialist workshop.</p>
 <p>Backup Light</p>	<p>The backup lamp is defective.</p> <p>► Check whether you are permitted to replace the bulb yourself (> page 110).</p> <p>or</p> <p>► Visit a qualified specialist workshop.</p>
 <p>Check Left Tail Lamp or Check Right Tail Lamp</p>	<p>The left or right-hand tail lamp is defective.</p> <p>► Check whether you are permitted to replace the bulb yourself (> page 110).</p> <p>or</p> <p>► Visit a qualified specialist workshop.</p>
 <p>Check Front Left Sidemarkers Lamp or Check Front Right Sidemarkers Lamp</p>	<p>The left or right front side marker lamp is defective.</p> <p>► Visit a qualified specialist workshop.</p>
 <p>Check Rear Left Sidemarkers Lamp or Check Rear Right Sidemarkers Lamp</p>	<p>The rear left or right side marker lamp is defective.</p> <p>► Check whether you are permitted to replace the bulb yourself (> page 110).</p> <p>or</p> <p>► Visit a qualified specialist workshop.</p>

Display messages	Possible causes/consequences and ► Solutions
 <p>Check Left Daytime Running Light or Check Right Daytime Running Light</p>	<p>The left-hand or right-hand daytime running lamp is faulty.</p> <ul style="list-style-type: none"> ► Visit a qualified specialist workshop. ► Check whether you are permitted to replace the bulb yourself (> page 110). <p>or</p> <ul style="list-style-type: none"> ► Visit a qualified specialist workshop.
 <p>Active Headlamps Inoperative</p>	<p>The active light function is defective.</p> <ul style="list-style-type: none"> ► Visit a qualified specialist workshop.
 <p>Malfunction See Operator's Manual</p>	<p>The exterior lighting is defective.</p> <ul style="list-style-type: none"> ► Visit a qualified specialist workshop.
 <p>Auto Lamp Function Inoperative</p>	<p>The light sensor is defective.</p> <ul style="list-style-type: none"> ► Visit a qualified specialist workshop.
 <p>Switch Off Lights</p>	<p>The lights are still switched on when you leave the vehicle. A warning tone also sounds.</p> <ul style="list-style-type: none"> ► Turn the light switch to AUTO.
<p>Adaptive Highbeam Assist Inoperative</p>	<p>Adaptive Highbeam Assist is faulty.</p> <ul style="list-style-type: none"> ► Visit a qualified specialist workshop.
<p>Adaptive Highbeam Assist Currently Unavailable See Operator's Manual</p>	<p>Adaptive Highbeam Assist is deactivated and temporarily inoperative. Possible causes are:</p> <ul style="list-style-type: none"> • the windshield in the camera's field of vision is dirty. • visibility is impaired due to heavy rain, snow or fog. <p>► Clean the windshield.</p> <p>If the system detects that the camera is fully operational again, the Adaptive Highbeam Assist Now Available message is displayed.</p> <p>Adaptive Highbeam Assist is operational again.</p>

Engine

Display messages

Possible causes/consequences and ► Solutions



Check Coolant
Level See
Operator's Manual

The coolant level is too low.

- ❗ Avoid making long journeys with too little coolant in the engine cooling system. The engine will otherwise be damaged.
- Add coolant, observing the warning notes before doing so (▷ page 283).
- If coolant needs to be added more often than usual, have the engine coolant system checked at a qualified specialist workshop.



The fan motor is faulty.

- At coolant temperatures below 248 °F (120 °C), drive to the nearest qualified specialist workshop.
- Avoid subjecting the engine to heavy loads, e.g. driving in mountainous terrain, and stop-and-go traffic.



Coolant Too Hot
Stop Vehicle Turn
Engine Off

The coolant is too hot.

A warning tone also sounds.

 **WARNING**



Do not drive when your engine is overheated. This can cause some fluids which may have leaked into the engine compartment to catch fire.



Steam from the overheated engine can also cause serious burns which can occur just by opening the hood.

There is a risk of injury.



- Pull over and stop the vehicle safely and switch off the engine, paying attention to road and traffic conditions.
- Secure the vehicle against rolling away (▷ page 152).
- Wait until the engine has cooled down.
- Make sure that the air supply to the engine radiator is not blocked, e.g. by snow, slush or ice.
- Do not start the engine again until the display message goes out and the coolant temperature is below 248 °F (120 °C). Otherwise, the engine could be damaged.
- Pay attention to the coolant temperature display.
- If the temperature increases again, visit a qualified specialist workshop immediately.

Under normal operating conditions and with the specified coolant level, the coolant temperature may rise to 248 °F (120 °C).

Display messages	Possible causes/consequences and ► Solutions
	<p>The battery is not being charged. A warning tone also sounds. Possible causes are:</p> <ul style="list-style-type: none"> • a defective alternator • a torn poly-V-belt • a malfunction in the electronics <p>► Pull over and stop the vehicle safely and switch off the engine, paying attention to road and traffic conditions. ► Open the hood. ► Check whether the poly-V-belt is torn.</p> <p>If the poly-V-belt is torn:</p> <p>! Do not continue driving. The engine could otherwise overheat. ► Consult a qualified specialist workshop.</p> <p>If the poly-V-belt is not damaged:</p> <p>► Visit a qualified specialist workshop immediately.</p>
 <p>Check Engine Oil At Next Refueling</p>	<p>The engine oil level has dropped to the minimum level. A warning tone also sounds.</p> <ul style="list-style-type: none"> ► Check the oil level when next refueling, at the latest (> page 281). ► If necessary, add engine oil (> page 282). ► Have the engine checked at a qualified specialist workshop if engine oil needs to be added more often than usual. <p>! Avoid long journeys with too little engine oil. The engine will otherwise be damaged.</p> <p>Information on approved engine oils can be obtained from any qualified specialist workshop or on the Internet at http://bevo.mercedes-benz.com.</p>
 <p>Fuel Level Low</p>	<p>The fuel level has dropped into the reserve range.</p> <ul style="list-style-type: none"> ► Refuel at the nearest gas station.

Display messages	Possible causes/consequences and ► Solutions
	There is only a very small amount of fuel in the fuel tank. ► Refuel at the nearest gas station without fail.
 Gas Cap Loose	The fuel system pressure is too low. The fuel filler cap is not closed correctly or the fuel system is leaking. ► Check that the fuel filler cap is correctly closed. If the fuel filler cap is not correctly closed: ► Close the fuel filler cap. If the fuel filler cap is correctly closed: ► Visit a qualified specialist workshop.

Driving systems

Display messages	Possible causes/consequences and ► Solutions
 Attention Assist: Take a Break!	Based on certain criteria, ATTENTION ASSIST has detected fatigue or a lack of concentration on the part of the driver. A warning tone also sounds. ► If necessary, take a break. During long journeys, take regular breaks in good time so you get enough rest.
 Attention Assist Inoperative	ATTENTION ASSIST is inoperative. ► Visit a qualified specialist workshop.
 HOLD Off	The HOLD function is deactivated. the vehicle is skidding. A warning tone also sounds. ► Reactivate the HOLD function later (▷ page 171). The HOLD function is deactivated. When the brake pedal is firmly depressed, an activation condition is not fulfilled. A warning tone also sounds. ► Check the activation conditions for the HOLD function (▷ page 171).
Radar Sensors Deactivated See Operator's Manual	The radar sensor system is deactivated. ► Switch on the radar sensor system (▷ page 205).



Display messages	Possible causes/consequences and ► Solutions
<p>Lane Keeping Assist Currently Unavailable See Operator's Manual</p>	<p>Lane Keeping Assist is deactivated and temporarily inoperative. Possible causes are:</p> <ul style="list-style-type: none"> • the windshield in the camera's field of vision is dirty. • visibility is impaired due to heavy rain, snow or fog. • there are no lane markings for a longer period. • the lane markings are worn, dark or covered, e.g. by dirt or snow. <p>When the causes stated above no longer apply, the display message disappears.</p> <p>Lane Keeping Assist is operational again.</p> <p>If the display message does not disappear:</p> <ul style="list-style-type: none"> ► Pull over and stop the vehicle safely as soon as possible, paying attention to road and traffic conditions. ► Secure the vehicle against rolling away (▷ page 152). ► Clean the windshield.
<p>Lane Keeping Assist Inoperative</p>	<p>Lane Keeping Assist is faulty.</p> <ul style="list-style-type: none"> ► Visit a qualified specialist workshop.
<p>Blind Spot Assist Currently Unavailable See Operator's Manual</p>	<p>Blind Spot Assist is temporarily inoperative. Possible causes are:</p> <ul style="list-style-type: none"> • the sensors are dirty. • function is impaired due to heavy rain or snow. • the radar sensor system is outside the operating temperature range. • the radar sensor system is temporarily inoperative, e.g. due to electromagnetic radiation emitted by nearby TV or radio stations or other sources of electromagnetic radiation. <p>The yellow  indicator lamps also light up in the exterior mirrors.</p> <p>When the causes stated above no longer apply, the display message disappears.</p> <p>Blind Spot Assist is operational again.</p> <p>If the display message does not disappear:</p> <ul style="list-style-type: none"> ► Pull over and stop the vehicle safely as soon as possible, paying attention to road and traffic conditions. ► Secure the vehicle against rolling away (▷ page 152). ► Clean the sensors (▷ page 289). ► Restart the engine.

Display messages	Possible causes/consequences and ► Solutions
Blind Spot Assist Inoperative	<p>Blind Spot Assist is defective.</p> <p>The yellow  indicator lamps also light up in the exterior mirrors.</p> <p>► Visit a qualified specialist workshop.</p>
Park Assist Canceled	<p>The driver's door is open and the driver's seat belt has not been fastened.</p> <p>► Repeat the parking process with the seat belt fastened and the driver's door closed.</p> <p>You have inadvertently touched the multifunction steering wheel while steering intervention was active.</p> <p>► While steering intervention is active, make sure that the multifunction steering wheel is not touched unintentionally.</p> <p>The vehicle has started to skid and ESP[®] has intervened.</p> <p>► Use Active Parking Assist again later (▷ page 175).</p>
Park Assist Inoperative	<p>You have just carried out a large number of turning or parking maneuvers.</p> <p>Active Parking Assist will become available again after approximately ten minutes (▷ page 175).</p> <p>► Pull over and stop the vehicle safely as soon as possible, paying attention to road and traffic conditions.</p> <p>► Switch off and restart the engine.</p> <p>If the display message continues to be displayed:</p> <p>► Visit a qualified specialist workshop.</p> <p>PARKTRONIC is defective.</p> <p>► Visit a qualified specialist workshop.</p>
DISTRONIC PLUS Off	<p>DISTRONIC PLUS has been deactivated (▷ page 162). If it was deactivated automatically, a warning tone also sounds.</p>
DISTRONIC PLUS Now Available	<p>DISTRONIC PLUS is operational again after having been temporarily unavailable. You can now reactivate DISTRONIC PLUS (▷ page 162).</p>

Display messages	Possible causes/consequences and ► Solutions
<p>DISTRONIC PLUS Currently Unavailable See Operator's Manual</p>	<p>DISTRONIC PLUS is temporarily inoperative. Possible causes are:</p> <ul style="list-style-type: none"> • function is impaired due to heavy rain or snow. • the sensors in the radiator trim are dirty • the radar sensor system is temporarily inoperative, e.g. due to electromagnetic radiation emitted by nearby TV or radio stations or other sources of electromagnetic radiation. • the system is outside the operating temperature range. • the on-board voltage is too low. <p>A warning tone also sounds.</p> <p>When the causes stated above no longer apply, the display message disappears.</p> <p>DISTRONIC is operational again.</p> <p>If the display message does not disappear:</p> <ul style="list-style-type: none"> ► Pull over and stop the vehicle safely as soon as possible, paying attention to road and traffic conditions. ► Secure the vehicle against rolling away (▷ page 152). ► Clean the sensors in the radiator trim (▷ page 289). ► Restart the engine.
<p>DISTRONIC PLUS Inoperative</p>	<p>DISTRONIC PLUS is defective. Adaptive Brake Assist may also have failed.</p> <p>A warning tone also sounds.</p> <ul style="list-style-type: none"> ► Visit a qualified specialist workshop.
<p>DISTRONIC PLUS Passive</p>	<p>You have depressed the accelerator pedal. DISTRONIC PLUS is no longer controlling the speed of the vehicle.</p> <ul style="list-style-type: none"> ► Remove your foot from the accelerator pedal.
<p>DISTRONIC PLUS - - - mph</p>	<p>An activation condition for DISTRONIC PLUS is not fulfilled.</p> <ul style="list-style-type: none"> ► Check the activation conditions for DISTRONIC PLUS (▷ page 164).

Display messages	Possible causes/consequences and ► Solutions
Cruise Control Inoperative	Cruise control is defective. A warning tone also sounds. ► Visit a qualified specialist workshop.
Cruise Control - - - mph	A condition for activating cruise control has not been fulfilled. You have tried to store a speed below 20 mph (30 km/h), for example. ► If conditions permit, drive faster than 20 mph (30 km/h) and store the speed. ► Check the activation conditions for cruise control (► page 161).

Tires	
Display messages	Possible causes/consequences and ► Solutions
Tire Pressure Check Tires	<p>Canada only:</p> <p>The tire pressure loss warning system has detected a significant loss in pressure.</p> <p>A warning tone also sounds.</p> <p> WARNING</p> <p>With tire pressures which are too low, there is a risk of the following hazards:</p> <ul style="list-style-type: none"> • they may burst, especially as the load and vehicle speed increase. • they may wear excessively and/or unevenly, which may greatly impair tire traction. • the driving characteristics, as well as steering and braking, may be greatly impaired. <p>There is a risk of an accident.</p> <ul style="list-style-type: none"> ► Stop the vehicle without making any sudden steering or braking maneuvers. Pay attention to the traffic conditions as you do so. ► Secure the vehicle against rolling away (> page 152). ► Check the tires and, if necessary, follow the instructions for a flat tire (> page 295). ► Check the tire pressures and, if necessary, correct the tire pressure. ► Restart the tire pressure loss warning system when the tire pressure is correct (> page 319).
Check Tire Pressure Then Restart Run Flat Indicator	<p>Canada only:</p> <p>The tire pressure loss warning system generated a display message and has not been restarted since.</p> <ul style="list-style-type: none"> ► Set the correct tire pressure in all four tires. ► Restart the tire pressure loss warning system (> page 319).
Run Flat Indicator Inoperative	<p>Canada only:</p> <p>The tire pressure loss warning system is faulty.</p> <ul style="list-style-type: none"> ► Visit a qualified specialist workshop.
Correct Tire Pressure	<p>The tire pressure is too low in at least one of the tires, or the tire pressure difference between the wheels is too great.</p> <ul style="list-style-type: none"> ► Check the tire pressures at the next opportunity (> page 320). ► If necessary, correct the tire pressure. ► Restart the tire pressure monitor (> page 322).



Display messages	Possible causes/consequences and ► Solutions
<p>Check Tires</p>	<p>The tire pressure in one or more tires has dropped significantly. The wheel position is displayed in the multifunction display. A warning tone also sounds.</p> <p> WARNING</p> <p>With tire pressures which are too low, there is a risk of the following hazards:</p> <ul style="list-style-type: none"> • they may burst, especially as the load and vehicle speed increase. • they may wear excessively and/or unevenly, which may greatly impair tire traction. • the driving characteristics, as well as steering and braking, may be greatly impaired. <p>There is a risk of an accident.</p> <ul style="list-style-type: none"> ► Stop the vehicle without making any sudden steering or braking maneuvers. Pay attention to the traffic conditions as you do so. ► Secure the vehicle against rolling away (▷ page 152). ► Check the tires and, if necessary, follow the instructions for a flat tire (▷ page 295). ► Check the tire pressure (▷ page 320). ► If necessary, correct the tire pressure.
<p>Warning Tire Malfunction</p>	<p>The tire pressure in one or more tires has dropped suddenly. The wheel position is shown in the multifunction display.</p> <p> WARNING</p> <p>If you drive with a flat tire, there is a risk of the following hazards:</p> <ul style="list-style-type: none"> • a flat tire affects the ability to steer or brake the vehicle. • You could lose control of the vehicle. • continued driving with a flat tire will cause excessive heat build-up and possibly a fire. <p>There is a risk of an accident.</p> <ul style="list-style-type: none"> ► Stop the vehicle without making any sudden steering or braking maneuvers. Pay attention to the traffic conditions as you do so. ► Secure the vehicle against rolling away (▷ page 152). ► Check the tires and, if necessary, follow the instructions for a flat tire (▷ page 295).





Display messages	Possible causes/consequences and ► Solutions
Tire Press. Monitor Currently Unavailable	Due to a source of radio interference, no signals can be received from the wheel sensors. The tire pressure monitor is temporarily malfunctioning. ► Drive on. The tire pressure monitor restarts automatically as soon as the problem has been solved.
TirePress. Sensor(s) Missing	There is no signal from the tire pressure sensor of one or several wheels. The pressure of the affected tire is not displayed in the multifunction display. ► Have the faulty tire pressure sensor replaced at a qualified specialist workshop.
Tire Pressure Monitor Inoperative No Wheel Sensors	The wheels mounted do not have a suitable tire pressure sensor. The tire pressure monitor is deactivated. ► Mount wheels with suitable tire pressure sensors. The tire pressure monitor is activated automatically after driving for a few minutes.
Tire Press. Monitor Inoperative	The tire pressure monitor is faulty. ► Visit a qualified specialist workshop.



Vehicle

Display messages	Possible causes/consequences and ► Solutions
Shift to 'P' or 'N' to Start Engine	You have attempted to start the engine with the transmission in position R or D . ► Shift the transmission to position P or N .
Auxiliary Battery Malfunction	The auxiliary battery for the automatic transmission is no longer being charged. ► Visit a qualified specialist workshop at the next opportunity. ► Until then, set the automatic transmission to position P before you switch off the engine. ► Before leaving the vehicle, apply the electric parking brake.
Depress Brake to Start Engine	You have attempted to start the engine with the transmission in position N without depressing the brake pedal. ► Depress the brake pedal.



Display messages	Possible causes/consequences and ► Solutions
To Deselect P or N Depress Brake and Start Engine	<p>You have attempted to shift the transmission to position R or D without starting the engine.</p> <ul style="list-style-type: none"> ► Start the engine. ► Depress the brake pedal. <p>i It is only possible to shift the transmission from position P to the desired position if you depress the brake pedal. Only then can the parking lock be deactivated. If you do not depress the brake pedal, you can move the DIRECT SELECT lever but the parking lock remains engaged.</p> <p>i At transmission fluid temperatures below -4 °F (-20 °C) you can only shift out of position P into another transmission position when the engine is running.</p>
Apply Brake to Shift from 'P'	<p>You have attempted to move the transmission selector lever to position R, N or D without depressing the brake pedal.</p> <ul style="list-style-type: none"> ► Depress the brake pedal.
Transmission Not in P Risk of Vehicle Rolling Away	<p>The driver's door is open and the transmission is in position R, N or D.</p> <p>A warning tone also sounds.</p> <ul style="list-style-type: none"> ► Shift the transmission to position P. ► Secure the vehicle against rolling away (▷ page 152).
Service Required Do Not Shift Gears Visit Dealer	<p>You cannot change the transmission position due to a malfunction. A warning tone also sounds.</p> <p>If transmission position D is selected:</p> <ul style="list-style-type: none"> ► Drive to a qualified specialist workshop without shifting the transmission from position D. <p>If transmission position R, N or P is selected:</p> <ul style="list-style-type: none"> ► Notify a qualified specialist workshop or breakdown service.
Only Shift to 'P' when Vehicle is Stationary	<p>The vehicle is moving.</p> <ul style="list-style-type: none"> ► Pull over and stop the vehicle safely as soon as possible, paying attention to road and traffic conditions. ► Shift the transmission to position P.
Reversing Not Possible Service Required	<p>The automatic transmission is malfunctioning. You cannot back up.</p> <ul style="list-style-type: none"> ► Visit a qualified specialist workshop.

Display messages	Possible causes/consequences and ► Solutions
Transmission Malfunction	The automatic transmission is malfunctioning. ► Visit a qualified specialist workshop.
Transmission Malfunction Stop	The automatic transmission is malfunctioning. ► Pull over and stop the vehicle safely as soon as possible, paying attention to road and traffic conditions. ► Secure the vehicle against rolling away (▷ page 152). ► Consult a qualified specialist workshop.
Stop Vehicle Shift to P Leave Engine Running	The automatic transmission has overheated. ► Drive on carefully. The automatic transmission is available again when the display message goes out. If the display message continues to be displayed: ► Pull over and stop the vehicle safely as soon as possible, paying attention to road and traffic conditions. ► Secure the vehicle against rolling away (▷ page 152). ► Wait until the automatic transmission has cooled down and the display message has disappeared.
	The tailgate is open. ⚠ WARNING When the engine is running, exhaust gases can enter the vehicle interior if the tailgate is open. There is a risk of poisoning. ► Close the tailgate.
	The hood is open. ⚠ WARNING The open hood may block your view when the vehicle is in motion. There is a risk of an accident. ► Pull over and stop the vehicle safely as soon as possible, paying attention to road and traffic conditions. ► Apply the electric parking brake. ► Close the hood.
	At least one door is open. A warning tone also sounds. ► Close all the doors.





Display messages	Possible causes/consequences and ► Solutions
 <p data-bbox="181 327 398 413">Power Steering Malfunction See Operator's Manual</p>	<p data-bbox="439 274 822 336">The power steering is malfunctioning. A warning tone also sounds.</p> <p data-bbox="448 354 602 381"> WARNING</p> <p data-bbox="439 396 855 458">You will need to use more force to steer. There is a risk of an accident.</p> <ul style="list-style-type: none"> <li data-bbox="439 467 1092 494">► Check whether you are able to apply the extra force required. <li data-bbox="439 503 1102 566">► If you are able to steer safely: carefully drive on to a qualified specialist workshop. <li data-bbox="439 569 1102 632">► If you are unable to steer safely: do not drive on. Contact the nearest qualified specialist workshop.
<p data-bbox="181 654 389 680">Phone No Service</p>	<p data-bbox="439 654 1040 713">Your vehicle is outside the network provider's transmitter/receiver range.</p> <ul style="list-style-type: none"> <li data-bbox="439 722 1050 784">► Wait until the mobile phone operational readiness symbol appears in the multifunction display.
 <p data-bbox="181 861 415 888">Check Washer Fluid</p>	<p data-bbox="439 808 1085 870">The washer fluid level in the washer fluid reservoir has dropped below the minimum.</p> <p data-bbox="439 879 1102 1005"> If you do not mix antifreeze with the washer fluid in the winter months, then the washer fluid could freeze in the washer fluid reservoir. In this case, the Check Washer Fluid display message may appear in the multifunction display.</p> <ul style="list-style-type: none"> <li data-bbox="439 1014 780 1041">► Add washer fluid (► page 284).
<p data-bbox="181 1068 363 1130">Wiper Malfunctioning</p>	<p data-bbox="439 1068 868 1094">The windshield wipers are malfunctioning.</p> <ul style="list-style-type: none"> <li data-bbox="439 1103 835 1130">► Visit a qualified specialist workshop.
<p data-bbox="181 1161 363 1250">Hazard Warning Flashers Malfunctioning</p>	<p data-bbox="439 1161 815 1188">The hazard warning lamps are faulty.</p> <ul style="list-style-type: none"> <li data-bbox="439 1197 835 1223">► Visit a qualified specialist workshop.



SmartKey	
Display messages	Possible causes/consequences and ► Solutions
 Key Does Not Belong to Vehicle	You have put the wrong SmartKey in the ignition lock. ► Use the correct SmartKey.
 Take Your Key from Ignition	The SmartKey is in the ignition lock. ► Remove the SmartKey.
 Obtain a New Key	The SmartKey needs to be replaced. ► Visit a qualified specialist workshop.









Warning and indicator lamps in the instrument cluster



Seat belts	
Problem	Possible causes/consequences and ► Solutions
 After starting the engine, the red seat belt warning lamp lights up for six seconds.	The seat belt warning lamp reminds the driver and front passenger to fasten their seat belts. ► Fasten your seat belt (▷ page 52).
 After starting the engine, the red seat belt warning lamp lights up. In addition, a warning tone sounds for up to six seconds.	The driver's seat belt is not fastened. ► Fasten your seat belt (▷ page 52). The warning tone ceases.
 The red seat belt warning lamp lights up after the engine starts, as soon as the driver's or the front-passenger door is closed.	The driver or front passenger has not fastened their seat belt. ► Fasten your seat belt (▷ page 52). The warning lamp goes out.
	There are objects on the front-passenger seat. ► Remove the objects from the front-passenger seat and stow them in a secure place. The warning lamp goes out.

Problem	Possible causes/consequences and ► Solutions
 <p>The red seat belt warning lamp flashes and an intermittent audible warning sounds.</p>	<p>The driver or front passenger has not fastened their seat belt. In addition, you are driving faster than 15 mph (25 km/h) or you have briefly driven faster than 15 mph (25 km/h).</p> <ul style="list-style-type: none"> ► Fasten your seat belt (▷ page 52). The warning lamp goes out and the intermittent warning tone ceases. <p>There are objects on the front-passenger seat. In addition, you are driving faster than 15 mph (25 km/h) or you have briefly driven faster than 15 mph (25 km/h).</p> <ul style="list-style-type: none"> ► Remove the objects from the front-passenger seat and stow them in a secure place. The warning lamp goes out and the intermittent warning tone ceases.





Safety systems	
Problem	Possible causes/consequences and ► Solutions
<p> (USA only)</p> <p> (Canada only)</p> <p>The red brake system warning lamp comes on while the engine is running. A warning tone also sounds.</p>	<p>There is not enough brake fluid in the brake fluid reservoir.</p> <p> WARNING</p> <p>The braking effect may be impaired.</p> <p>There is a risk of an accident.</p> <ul style="list-style-type: none"> ► Pull over and stop the vehicle safely as soon as possible, paying attention to road and traffic conditions. Do not continue driving under any circumstances. ► Secure the vehicle against rolling away (► page 152). ► Do not add brake fluid. Adding more will not remedy the malfunction. ► Consult a qualified specialist workshop. ► Observe the additional display messages in the multifunction display.
<p></p> <p>The yellow ABS warning lamp is lit while the engine is running.</p>	<p>ABS (Anti-lock Braking System) is deactivated due to a malfunction. Therefore, BAS (Brake Assist), COLLISION PREVENTION ASSIST, COLLISION PREVENTION ASSIST PLUS, ESP® (Electronic Stability Program), the HOLD function and hill start assist, for example, are also deactivated. ATTENTION ASSIST is deactivated.</p> <p> WARNING</p> <p>The brake system continues to function normally, but without the functions listed above. The wheels could therefore lock if you brake hard, for example.</p> <p>The steerability and braking characteristics may be severely affected. The braking distance in an emergency braking situation can increase.</p> <p>If ESP® is not operational, ESP® is unable to stabilize the vehicle. There is an increased risk of skidding and an accident.</p> <ul style="list-style-type: none"> ► Observe the additional display messages in the multifunction display. ► Drive on carefully. ► Visit a qualified specialist workshop. <p>If the ABS control unit is faulty, there is also a possibility that other systems, such as the navigation system or the automatic transmission, will not be available.</p>





Problem	Possible causes/consequences and ► Solutions
 <p>The yellow ABS warning lamp is lit while the engine is running.</p>	<p>ABS is temporarily unavailable. BAS, COLLISION PREVENTION ASSIST, COLLISION PREVENTION ASSIST PLUS, ESP[®], EBD (electronic brake force distribution), the HOLD function and hill start assist, for example, are therefore also deactivated.</p> <p>Possible causes are:</p> <ul style="list-style-type: none"> • self-diagnosis is not yet complete. • the on-board voltage may be insufficient. <p>ATTENTION ASSIST is deactivated.</p> <p> WARNING</p> <p>The brake system continues to function normally, but without the functions listed above. The front and rear wheels could therefore lock if you brake hard, for example.</p> <p>The steerability and braking characteristics may be severely affected. The braking distance in an emergency braking situation can increase.</p> <p>If ESP[®] is not operational, ESP[®] is unable to stabilize the vehicle. There is a risk of an accident.</p> <ul style="list-style-type: none"> ► Carefully drive a suitable distance, making slight steering movements at a speed above 12 mph (20 km/h). The functions mentioned above are available again when the warning lamp goes out. <p>If the warning lamp is still on:</p> <ul style="list-style-type: none"> ► Observe the additional display messages in the multifunction display. ► Drive on carefully. ► Visit a qualified specialist workshop.



Problem	Possible causes/consequences and ► Solutions
 <p>The yellow ABS warning lamp is lit while the engine is running. A warning tone also sounds.</p>	<p>EBD is malfunctioning. Therefore, ABS, BAS, COLLISION PREVENTION ASSIST, COLLISION PREVENTION ASSIST PLUS, ESP[®], the HOLD function and hill start assist, for example, are not available either.</p> <p>ATTENTION ASSIST is deactivated.</p> <p> WARNING</p> <p>The brake system continues to function normally, but without the functions listed above. The front and rear wheels could therefore lock if you brake hard, for example.</p> <p>The steerability and braking characteristics may be severely affected. The braking distance in an emergency braking situation can increase.</p> <p>If ESP[®] is not operational, ESP[®] is unable to stabilize the vehicle. There is an increased risk of skidding and an accident.</p> <ul style="list-style-type: none"> ► Observe the additional display messages in the multifunction display. ► Drive on carefully. ► Visit a qualified specialist workshop.
<p> (USA only)</p> <p> (Canada only)</p> <p>  </p> <p>The red brake warning lamp, the yellow ESP[®] and ESP[®] OFF warning lamps and the yellow ABS warning lamp are lit while the engine is running.</p>	<p>ABS and ESP[®] are malfunctioning. Therefore, BAS, COLLISION PREVENTION ASSIST, COLLISION PREVENTION ASSIST PLUS, EBD, the HOLD function and hill start assist, for example, are not available either.</p> <p>ATTENTION ASSIST is deactivated.</p> <p> WARNING</p> <p>The brake system continues to function normally, but without the functions listed above. The front and rear wheels could therefore lock if you brake hard, for example.</p> <p>The steerability and braking characteristics may be severely affected. The braking distance in an emergency braking situation can increase.</p> <p>If ESP[®] is not operational, ESP[®] is unable to stabilize the vehicle. There is an increased risk of skidding and an accident.</p> <ul style="list-style-type: none"> ► Observe the additional display messages in the multifunction display. ► Drive on carefully. ► Visit a qualified specialist workshop.

Problem	Possible causes/consequences and ► Solutions
 <p>The yellow ESP[®] warning lamp flashes while the vehicle is in motion.</p>	<p>ESP[®] or traction control has intervened because there is a risk of skidding or at least one wheel has started to spin. Cruise control or DISTRONIC PLUS is deactivated.</p> <ul style="list-style-type: none"> ► When pulling away, only depress the accelerator pedal as far as necessary. ► Ease off the accelerator pedal while the vehicle is in motion. ► Adapt your driving style to suit the road and weather conditions. ► Do not deactivate ESP[®]. <p>For exceptions, see: (▷ page 68).</p>
 <p>The yellow ESP[®] OFF warning lamp is lit while the engine is running.</p>	<p>ESP[®] and ESP[®] trailer stabilization are deactivated. ESP[®] will not stabilize the vehicle if it starts to skid or if a wheel starts to spin.</p> <p>⚠ WARNING</p> <p>If ESP[®] is switched off, ESP[®] is unable to stabilize the vehicle. There is an increased risk of skidding and an accident.</p> <ul style="list-style-type: none"> ► Reactivate ESP[®]. <p>For exceptions, see: (▷ page 68).</p> <ul style="list-style-type: none"> ► Adapt your driving style to suit the road and weather conditions. <p>If ESP[®] cannot be activated:</p> <ul style="list-style-type: none"> ► Have ESP[®] checked at a qualified specialist workshop.
 <p>The yellow ESP[®] and ESP[®] OFF warning lamps are lit while the engine is running.</p>	<p>ESP[®], BAS, COLLISION PREVENTION ASSIST, COLLISION PREVENTION ASSIST PLUS, the HOLD function and hill start assist are not available due to a malfunction. ATTENTION ASSIST is deactivated.</p> <p>⚠ WARNING</p> <p>The brake system continues to function normally, but without the functions listed above. The braking distance in an emergency braking situation can thus increase.</p> <p>If ESP[®] is not operational, ESP[®] is unable to stabilize the vehicle. There is an increased risk of skidding and an accident.</p> <ul style="list-style-type: none"> ► Observe the additional display messages in the multifunction display. ► Drive on carefully. ► Visit a qualified specialist workshop.

Problem	Possible causes/consequences and ► Solutions
 <p>The yellow ESP[®] and ESP[®] OFF warning lamps are lit while the engine is running.</p>	<p>ESP[®], BAS, the HOLD function and hill start assist are temporarily unavailable.</p> <p>COLLISION PREVENTION ASSIST/COLLISION PREVENTION ASSIST PLUS may also have failed.</p> <p>ATTENTION ASSIST is deactivated.</p> <p>self-diagnosis is not yet complete.</p> <p>▲ WARNING</p> <p>The brake system continues to function normally, but without the functions listed above.</p> <p>The braking distance in an emergency braking situation can thus increase.</p> <p>If ESP[®] is not operational, ESP[®] is unable to stabilize the vehicle. There is an increased risk of skidding and an accident.</p> <ul style="list-style-type: none"> ► Carefully drive a suitable distance, making slight steering movements at a speed above 12 mph (20 km/h). The functions mentioned above are available again when the warning lamp goes out. <p>If the warning lamp is still on:</p> <ul style="list-style-type: none"> ► Observe the additional display messages in the multifunction display. ► Drive on carefully. ► Visit a qualified specialist workshop.



Problem	Possible causes/consequences and ► Solutions
<p> (USA only)  (Canada only)</p> <p>The red indicator lamp for the electric parking brake flashes or lights up and/or the yellow warning lamp for the electric parking brake lights up.</p>	<p>► Observe the additional display messages in the multifunction display.</p>
<p></p> <p>The red SRS warning lamp is lit while the engine is running.</p>	<p>There is a malfunction in the SRS (Supplemental Restraint System).</p> <p> WARNING</p> <p>The air bags or Emergency Tensioning Devices may either be triggered unintentionally or, in the event of an accident, may not be triggered.</p> <p>There is an increased risk of injury.</p> <p>► Drive on carefully. ► Have SRS checked at a qualified specialist workshop immediately.</p> <p>For further information about SRS, see (► page 40).</p>





Engine	
Problem	Possible causes/consequences and ► Solutions
 <p>The yellow Check Engine warning lamp lights up while the engine is running.</p>	<p>There may be a malfunction, for example:</p> <ul style="list-style-type: none"> • in the engine management • in the fuel injection system • in the exhaust system • in the ignition system • in the fuel system <p>The emission limit values may be exceeded and the engine may be running in emergency mode.</p> <p>► Have the vehicle checked as soon as possible at a qualified specialist workshop.</p> <p>i In some states, you must immediately visit a qualified specialist workshop as soon as the yellow Check Engine warning lamp lights up. This depends on the locally applicable legal requirements. If in doubt, check whether such legal regulations apply in the state in which you are currently driving.</p>
 <p>The yellow reserve fuel warning lamp lights up while the engine is running.</p>	<p>The fuel level has dropped into the reserve range.</p> <p>► Refuel at the nearest gas station.</p>
 <p>The yellow reserve fuel warning lamp flashes while the engine is running.</p>	<p>The fuel system pressure is too low. The fuel filler cap is not closed correctly or the fuel system is leaking.</p> <p>► Check that the fuel filler cap is correctly closed.</p> <p>► If the fuel filler cap is not correctly closed: close the fuel filler cap.</p> <p>► If the fuel filler cap is closed: visit a qualified specialist workshop.</p>
 <p>The red coolant warning lamp lights up while the engine is running and the coolant temperature gage is at the start of the scale.</p>	<p>The temperature sensor for the coolant temperature gage is defective.</p> <p>The coolant temperature is no longer being monitored. There is a risk of engine damage if the coolant temperature is too high.</p> <p>► Pull over and stop the vehicle safely and switch off the engine, paying attention to road and traffic conditions. Do not continue driving under any circumstances.</p> <p>► Secure the vehicle against rolling away (▷ page 152).</p> <p>► Consult a qualified specialist workshop.</p>

Problem	Possible causes/consequences and ► Solutions
 <p>The red coolant warning lamp comes on while the engine is running.</p>	<p>The coolant level is too low.</p> <p>If the coolant level is correct, the airflow to the engine radiator may be blocked or the electric engine radiator fan may be malfunctioning.</p> <p>The coolant is too hot and the engine is no longer being cooled sufficiently.</p> <ul style="list-style-type: none"> ► Observe the additional display messages in the multifunction display. ► Pull over and stop the vehicle safely and switch off the engine, paying attention to road and traffic conditions. ► Secure the vehicle against rolling away (▷ page 152). ► Leave the vehicle and keep a safe distance from the vehicle until the engine has cooled down. ► Check the coolant level and add coolant (▷ page 283). Observe the warning notes. ► If you need to add coolant more often than usual, have the engine coolant system checked. ► Make sure that the air supply to the engine radiator is not blocked, e.g. by snow, slush or ice. ► Do not start the engine again until the coolant temperature is under 248 °F (120 °C). Otherwise, the engine could be damaged. ► Drive to the nearest qualified specialist workshop. ► Avoid subjecting the engine to heavy loads, e.g. driving in mountainous terrain, and stop-and-go traffic.
 <p>The red coolant warning lamp comes on while the engine is running. A warning tone also sounds.</p>	<p>The coolant temperature has exceeded 248 °F (120 °C). The airflow to the engine radiator may be blocked or the coolant level may be too low.</p> <p> WARNING</p> <p>The engine is not being cooled sufficiently and may be damaged. Do not drive when your engine is overheated. This can cause some fluids which may have leaked into the engine compartment to catch fire.</p> <p>Vapor from the overheated engine can also cause serious burns which can occur just by opening the hood.</p> <p>There is a risk of injury.</p> <ul style="list-style-type: none"> ► Observe the additional display messages in the multifunction display. ► Pull over and stop the vehicle safely and switch off the engine, paying attention to road and traffic conditions. ► Secure the vehicle against rolling away (▷ page 152).

Problem	Possible causes/consequences and ► Solutions
	<ul style="list-style-type: none"> ▶ Leave the vehicle and keep a safe distance from the vehicle until the engine has cooled down. ▶ Check the coolant level and add coolant (▷ page 283). Observe the warning notes. ▶ If you need to add coolant more often than usual, have the engine coolant system checked. ▶ Make sure that the air supply to the engine radiator is not blocked, e.g. by snow, slush or ice. ▶ At coolant temperatures under 248 °F (120 °C), drive to the next qualified specialist workshop. ▶ Avoid subjecting the engine to heavy loads, e.g. driving in mountainous terrain, and stop-and-go traffic.

Driving systems

Problem	Possible causes/consequences and ► Solutions
 <p>The red distance warning lamp lights up while the vehicle is in motion.</p>	<p>The distance to the vehicle in front is too small for the speed selected.</p> <ul style="list-style-type: none"> ▶ Increase the distance.
 <p>The red distance warning lamp lights up while the vehicle is in motion. A warning tone also sounds.</p>	<p>You are approaching a vehicle or a stationary obstacle in your line of travel at too high a speed.</p> <ul style="list-style-type: none"> ▶ Be prepared to brake immediately. ▶ Pay careful attention to the traffic situation. You may have to brake or take evasive action. <p>For further information about the distance warning function of COLLISION PREVENTION ASSIST (▷ page 64).</p> <p>For further information about COLLISION PREVENTION ASSIST PLUS (▷ page 66).</p>

Tires	
Problem	Possible causes/consequences and ► Solutions
 The yellow tire pressure monitor warning lamp (pressure loss/malfunction) is lit.	<p>The tire pressure monitor has detected a loss of pressure in at least one of the tires.</p> <p> WARNING</p> <p>With tire pressures which are too low, there is a risk of the following hazards:</p> <ul style="list-style-type: none"> • they may burst, especially as the load and vehicle speed increase. • they may wear excessively and/or unevenly, which may greatly impair tire traction. • the driving characteristics, as well as steering and braking, may be greatly impaired. <p>There is a risk of an accident.</p> <ul style="list-style-type: none"> ► Stop the vehicle without making any sudden steering or braking maneuvers. Pay attention to the traffic conditions as you do so. ► Secure the vehicle against rolling away (▷ page 152). ► Observe the additional display messages in the multifunction display. ► Check the tires and, if necessary, follow the instructions for a flat tire (▷ page 295). ► Check the tire pressure (▷ page 320). ► If necessary, correct the tire pressure.
 The yellow tire pressure monitor warning lamp (pressure loss/malfunction) flashes for approximately one minute and then remains lit.	<p>The tire pressure monitor is faulty.</p> <p> WARNING</p> <p>The system is possibly unable to recognize or register low tire pressure.</p> <p>There is a risk of an accident.</p> <ul style="list-style-type: none"> ► Observe the additional display messages in the multifunction display. ► Visit a qualified specialist workshop.

Useful information	250
Loading guidelines	250
Stowage areas	251
Features	261

Useful information

- i** This Operator's Manual describes all models and all standard and optional equipment of your vehicle available at the time of publication of the Operator's Manual. Country-specific differences are possible. Please note that your vehicle may not be equipped with all features described. This also applies to safety-related systems and functions.
- i** Read the information on qualified specialist workshops: (> page 25).

Loading guidelines

WARNING

If objects, luggage or loads are not secured or not secured sufficiently, they could slip, tip over or be flung around and thereby hit vehicle occupants. There is a risk of injury, particularly in the event of sudden braking or a sudden change in direction.

Always store objects so that they cannot be flung around. Secure objects, luggage or loads against slipping or tipping before the journey.

WARNING

Combustion engines emit poisonous exhaust gases such as carbon monoxide. If the tailgate is open when the engine is running, particularly if the vehicle is moving, exhaust fumes could enter the passenger compartment. There is a risk of poisoning.

Turn off the engine before opening the tailgate. Never drive with the tailgate open.

The handling characteristics of a laden vehicle are dependent on the distribution of the load within the vehicle. For this reason, you should observe the following notes when transporting a load:

- Never exceed the maximum permissible gross vehicle weight or the gross axle

weight rating of the vehicle (including occupants). The values are specified on the vehicle identification plate on the B-pillar of the driver's door.

- The cargo compartment is the preferred place to carry objects.
 - Position heavy loads as far forwards as possible and as low down in the cargo compartment as possible.
 - The load must not protrude above the upper edge of the seat backrests.
 - Always place the load against the rear or front seat backrests. Make sure that the seat backrests are securely locked into place.
 - Always place the load behind unoccupied seats if possible.
 - Use the cargo tie down rings and the parcel nets to transport loads and luggage.
 - Use cargo tie-down rings and fastening materials appropriate for the weight and size of the load.
 - Hook in the cargo net when loading.
 - The maximum load capacity of the stowage well under the cargo compartment floor is 55 lbs (25 kg).
 - Secure the load with sufficiently strong and wear-resistant tie-downs. pad sharp edges for protection.
- i** Do not position the load on one part of the folding cargo compartment floor only. The maximum load capacity of the folding cargo compartment floor is 220 lbs (100 kg). Distribute the weight evenly to avoid damaging the cargo compartment floor. Place a solid board under the load if necessary. Please note that the load on the cargo compartment floor will be increased when the load is lashed down.

Stowage areas

Stowage space

Important safety notes

⚠ WARNING

If objects in the passenger compartment are stowed incorrectly, they can slide or be thrown around and hit vehicle occupants. There is a risk of injury, particularly in the event of sudden braking or a sudden change in direction.

- Always stow objects so that they cannot be thrown around in such situations.
- Always make sure that objects do not protrude from stowage spaces, parcel nets or stowage nets.
- Close the lockable stowage spaces while driving.
- Stow and secure objects that are heavy, hard, pointy, sharp-edged, fragile or too large in the cargo compartment.

Observe the loading guidelines (▷ page 250).

Stowage compartments in the front

Glove box

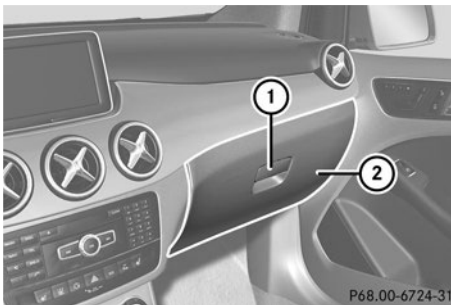

► **To open:** pull handle ① and open glove box flap ②.

► **To close:** fold glove box flap ② upwards until it engages.

i There is a pen holder at the top of the glove box flap.

Eyeglasses compartment

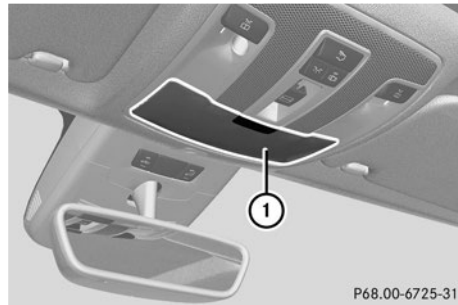

► **To open:** press marking ①.

Make sure that the eyeglasses compartment is always closed while the vehicle is in motion.

Stowage compartment in the center console



Illustration: vehicles with DIRECT SELECT lever

► **To open:** press the marking on cover ①.

i Depending on the vehicle's equipment, there is an open instead of a closed stowage compartment or an ashtray in the center console.

Stowage compartment in front of the armrest (vehicles with automatic transmission)



Vehicles with DIRECT SELECT lever

► **To open:** press the marking on cover ①.

i You can remove the non-slip mat and the insert for cleaning. When removing the insert you will have to overcome some slight resistance.

Stowage compartment under the armrest

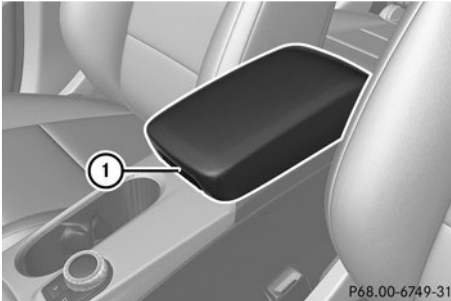

► **To open:** on vehicles with moveable armrests, make sure that the armrest is in the rearmost position.

► Press button ① and fold the armrest up.

i Depending on the vehicle's equipment, a USB connection and an AUX IN connection or a Media Interface are installed in the stowage compartment. A Media Interface is a universal interface for portable audio equipment, e.g. for an iPod® or MP3 player (see the separate Audio or COMAND Operating Instructions).

Stowage compartment under the driver's seat and front-passenger seat

⚠ WARNING

If you exceed the maximum load for the stowage compartment, the cover may not be able to restrain the items. Items may be thrown out of the stowage compartment and hit vehicle occupants. There is a risk of injury, particularly in the event of sudden braking or a sudden change in direction.

Never exceed the maximum permissible load for the stowage compartment. Stow and secure heavy objects in the cargo compartment.

The maximum permissible load of the stowage compartment is 2.6 lbs (1.5 kg).

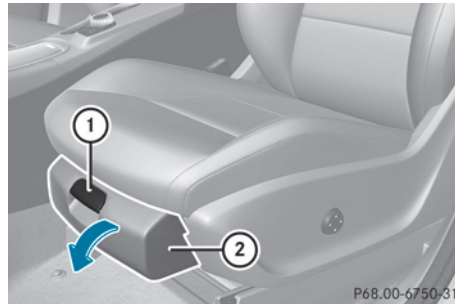

► **To open:** pull handle ① up and fold cover ② forwards.

Stowage space in the rear

Stowage compartment in the rear center console

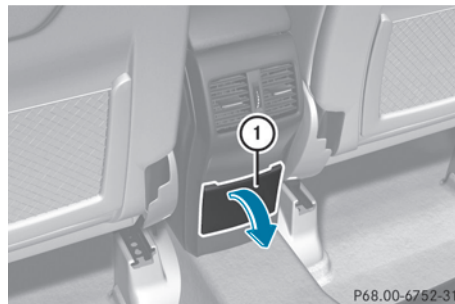

- ▶ **To open:** pull down the top of stowage compartment ① by the edge of the handle.

i Depending on the vehicle's equipment, there may be an open stowage space above the stowage compartment.

Folding table

WARNING

If the folding table is folded out while the vehicle is in motion, passengers can be thrown against it, particularly in the event of an accident, heavy braking or a sudden change of direction. There is a risk of injury. Fold the folding table away before each journey.

- ❗ Do not load the folding table with more than the maximum permissible load of 4.4 lbs (2 kg).

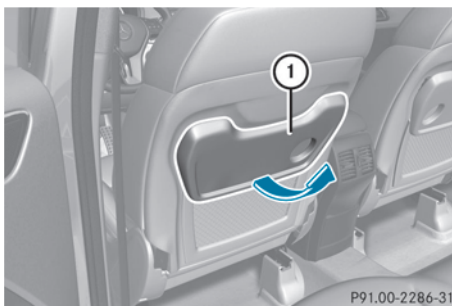

- ▶ **To fold out:** pull folding table ① up in the direction of the arrow to the desired position.
- ▶ **To fold away:** push folding table ① down onto the backrest.

Parcel nets

Parcel nets are located in the front-passenger footwell and on the back of the driver's and the front-passenger seat.

Observe the loading guidelines (▷ page 250) and the safety notes regarding stowage spaces (▷ page 251).

Folding backrest on the front-passenger seat

WARNING

If the backrest of the front-passenger seat is folded forward, rear seat passengers can come in contact with parts of the seat mechanism, particularly in the event of an accident, heavy braking or a sudden change of direction. There is a risk of injury.

If a passenger travels in the vehicle while the front-passenger seat is folded forward, they must sit in the rear seat behind the driver.

The backrest of the front-passenger seat can be folded forwards to increase the cargo compartment capacity.

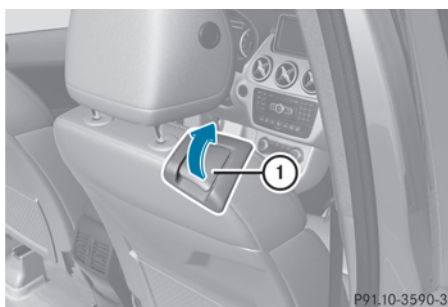

- ▶ **To fold forward:** gently push the backrest back.
- ▶ Pull release handle ① and fold the backrest fully onto the seat cushion until it engages.
- ▶ **To fold back:** gently push the backrest down and pull release handle ①.
- ▶ Fold the seat backrest back until it engages.

Through-loading facility in the rear

Observe the loading guidelines (▷ page 250).

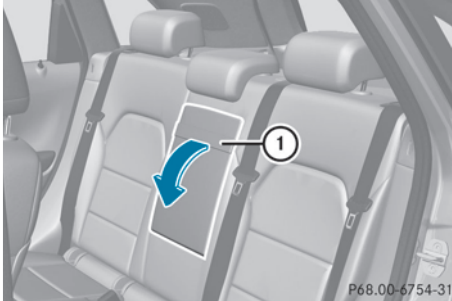

- ▶ **To open:** fold down seat armrest ①.
- ▶ Pull the cover, which can now be seen, forwards by the grip until it lies on armrest ①.
- ▶ Pull the center head restraint on the rear bench seat into the uppermost position (▷ page 95).

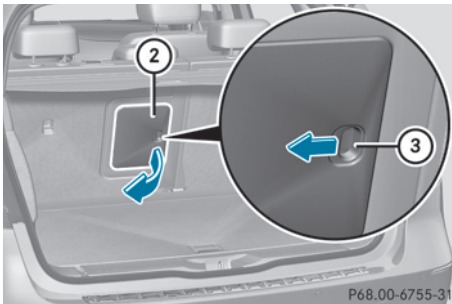

- ▶ Slide locking mechanism ③ in the direction of the arrow.
- ▶ Swing flap ② fully to the side. Flap ② is held open by a magnet.
- ▶ **To close:** swing flap ② in the cargo compartment back until it engages.
- ▶ Fold the cover forwards until it engages into armrest ①.
- ▶ Fold armrest ① up fully if necessary.

Cargo compartment enlargement

Important safety notes

WARNING

If the rear bench seat/rear seat and seat backrest are not engaged they could fold forwards, e.g. when braking suddenly or in the event of an accident.

- The vehicle occupant would thereby be pushed into the seat belt by the rear bench seat/rear seat or by the seat backrest. The seat belt can no longer offer the intended level of protection and could even cause injuries.
- Objects or loads in the trunk/cargo compartment cannot be restrained by the seat backrest.

There is an increased risk of injury.

Before every trip, make sure that the seat backrests and the rear bench seat/rear seat are engaged.

- ❗ Before folding the backrest in the rear compartment forwards, make sure that the rear compartment armrest and the cupholder are folded in. They may otherwise be damaged.

Observe the loading guidelines (▷ page 250).

Vehicles without the EASY-VARIO-PLUS system

Folding the rear seat backrest forward

The left-hand and right-hand rear seat backrests can be folded forwards separately to increase the cargo compartment capacity.

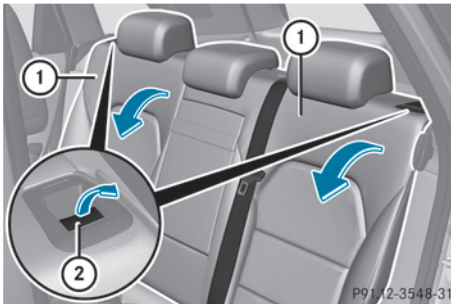

- ▶ Fully insert the backrest head restraints (▷ page 96).
- ▶ Move the driver's or front-passenger seat forward if necessary.
- ▶ Pull left-hand or right-hand release handle ② of the seat backrest forwards. Corresponding seat backrest ① is released.
- ▶ Fold backrest ① forwards.
- ▶ Move the driver's or front-passenger seat back if necessary.

Folding the rear seat backrest back

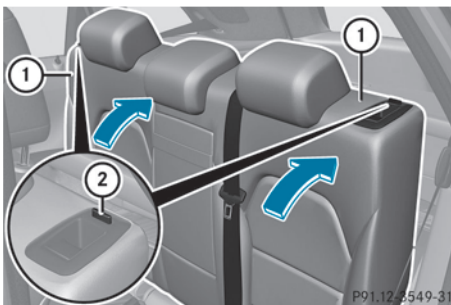

- ▶ Move the driver's or front-passenger seat forward if necessary.
- !** Make sure that the seat belt does not become trapped when folding the rear seat backrest back. Otherwise, it could be damaged.
- ▶ Fold seat backrest ① back until it engages. Red lock status indicator ② is no longer visible.

- ▶ Adjust the head restraints if necessary (▷ page 96).
- ▶ Move the driver's or front-passenger seat back if necessary.

Vehicles with the EASY-VARIO-PLUS system

Folding the rear seat backrest forward

The left-hand and right-hand rear seat backrests can be folded forwards separately to increase the cargo compartment capacity.

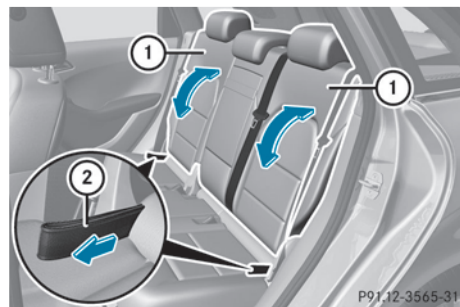

- ▶ Fully insert the backrest head restraints (▷ page 96).
- ▶ Move the rear seat as far back as possible (▷ page 257).
- ▶ Move the driver's or front-passenger seat forward if necessary.
- ▶ Pull right or left loop ② on the backrest in the direction of the arrow. Corresponding seat backrest ① is released.
- ▶ Fold down backrest ① fully.
- ▶ Move the driver's or front-passenger seat back if necessary.

Folding the rear seat backrest back

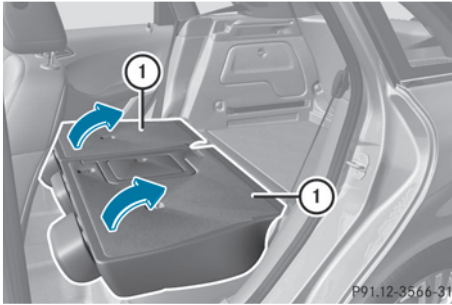

- ▶ Move the driver's or front-passenger seat forward if necessary.
- ❗ Make sure that the seat belt does not become trapped when folding the rear seat backrest back. Otherwise, it could be damaged.
- ▶ Swing backrest ① back.
- ▶ Adjust the backrest to the desired angle by pulling the loop (▷ page 256).
- ▶ Adjust the head restraints if necessary (▷ page 96).
- ▶ Move the driver's or front-passenger seat back if necessary.

Notes on using the cargo compartment

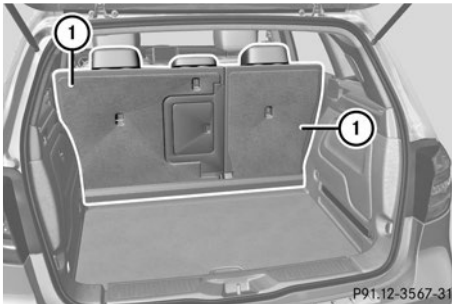

Load position

Making the best use of your cargo compartment:

- Load capacity is increased when backrest ① is set to the load position (90°) (▷ page 256).
- Vehicles with a height-adjustable trunk floor: a level load surface can be obtained by moving the trunk floor to the upper position (▷ page 260).
- A larger load area can be obtained by moving the rear bench seat as far forward as possible (▷ page 257).
- The load area can be lengthened by folding forward the folding backrest of the front-passenger seat (▷ page 253) and the corresponding backrest in the rear.

Adjusting the angle of the rear seat backrests

You can set the angle of the seat backrests to one of 13 detent positions.

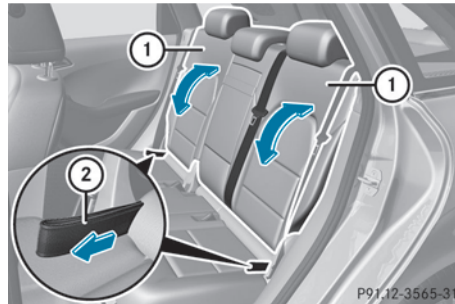

- ▶ Pull right or left release loop ② forwards in the direction of the arrow. Corresponding seat backrest ① is released.
- ▶ Pull backrest ① forward in the direction of the arrow, or push it back and let it engage.
- ▶ To ensure that the backrest has engaged, lean firmly against backrest ①.

i The angle and fore/aft position of the left and right rear seats can be separately adjusted for each seat in order to make better use of the cargo compartment.

Depending on the angle of the backrest, therefore, the right and left rear seats can be pushed back varying distances until the backrest is resting against the cargo compartment cover.

If the backrest comes into contact with surrounding parts of the cargo compartment paneling, reduce the angle of the backrest.

Adjusting the seat fore-and-aft position

! When moving the rear seats back, make sure there are no objects in the footwell or behind the seats. The rear seats and/or the objects could otherwise be damaged.

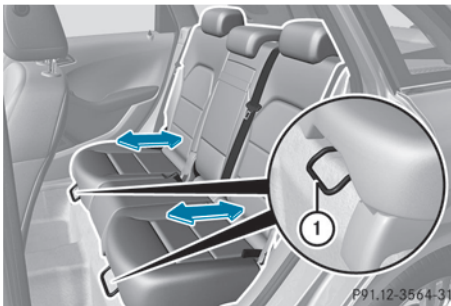

- ▶ Lift the left or right release handle and slide the corresponding seat forwards or backwards.
- ▶ Let go of the release handle again. Make sure that you hear the seat engage in position.

Securing cargo

Cargo tie-down rings

Observe the following notes on securing loads:

- Observe the loading guidelines (▷ page 250).
- Secure the load using the cargo tie-down rings.
- Distribute the load on the cargo tie-down rings evenly.

- Do not use elastic straps or nets to secure a load, as these are only intended as an anti-slip protection for light loads.
- Do not route tie-downs across sharp edges or corners.
- Pad sharp edges for protection.

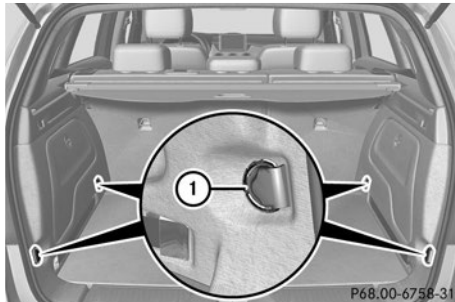

① Cargo tie-down rings

Bag hook

⚠ WARNING

The bag hooks cannot restrain heavy objects or items of luggage. Objects or items of luggage could be flung around and thereby hit vehicle occupants when braking or abruptly changing directions. There is a risk of injury. Only hang light objects on the bag hooks. Never hang hard, sharp-edged or fragile objects on the bag hooks.

! The bag hook can bear a maximum load of 6.6lbs (3kg) and should not be used to secure a load.

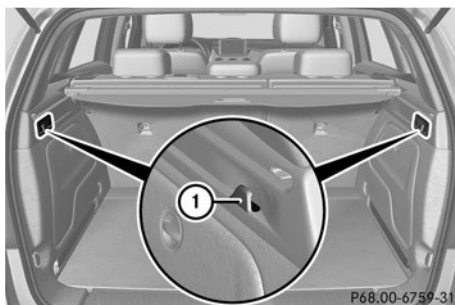

① Bag hook

Cargo compartment cover

Important safety notes

WARNING

On its own, the cargo compartment cover cannot secure or restrain heavy objects, items of luggage and heavy loads. You could be hit by an unsecured load during sudden changes in direction, braking or in the event of an accident. There is an increased risk of injury or even fatal injury.

Always store objects so that they cannot be flung around. Secure objects, luggage or loads against slipping or tipping over, e.g. by using tie downs, even if you are using the cargo compartment cover.

! When loading the vehicle, make sure that you do not stack the load in the cargo compartment higher than the lower edge of the side windows. Do not place heavy objects on top of the cargo compartment cover.

! When removing and installing the cargo compartment cover, ensure that its end caps do not scrape the light-colored parts of the vehicle.

The cargo compartment cover is located behind the rear bench seat backrest.

Extending/retracting the cargo compartment cover

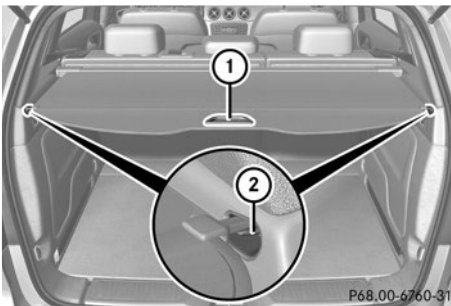

- ▶ **To extend:** pull the cargo compartment cover back by grab handle (1) and clip it into retainers (2) on the left and right.
- ▶ **To retract:** unhook the cargo compartment cover from retainers (2) on the left and right and guide it forwards by grab handle (1) until it is fully retracted.

Installing/removing the cargo compartment cover

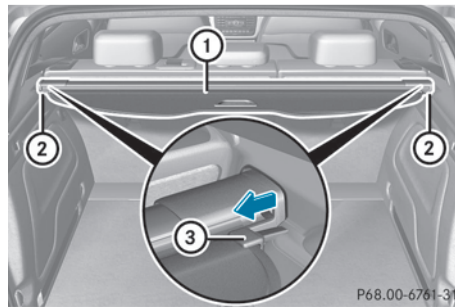

- ▶ **To remove:** make sure that the cargo compartment cover is rolled up.
- ▶ Push in the end cap of cargo compartment cover (1) in the direction of the arrow on the right or left side using grip (3).
- ▶ Push cargo compartment cover (1) into opposite anchorage (2).
- ▶ Remove cargo compartment cover (1) upwards.
- ▶ **To install:** set cargo compartment cover (1) on the right or left-hand side in anchorage (2).
- ▶ Push in the opposite end cap of cargo compartment cover (1) in the direction of the arrow and insert cargo compartment cover (1) into opposite anchorage (2).

Cargo net

Important safety notes

WARNING

On its own, the cargo net cannot secure or restrain heavy objects, items of luggage and heavy loads. You could be hit by an unsecured load during sudden changes in direction, braking or in the event of an accident. There is an increased risk of injury or even fatal injury.

Always store objects so that they cannot be flung around. Secure objects, luggage or loads against slipping or tipping over, e.g. by using tie downs, even if you are using the cargo net.

It is important to use a cargo net if you load the vehicle with small objects above the seat backrests. For safety reasons, always use a cargo net when transporting loads.

The cargo net is located in the stowage space under the cargo compartment floor (▷ page 259).

- ▶ Open both Velcro fasteners and remove the cargo net.
- ▶ Unroll and unfold the cargo net. The joints on the upper and lower guide rod should engage audibly.

The corresponding cargo tie down rings for tightening the cargo net are in the cargo compartment (▷ page 257).

Attaching and tightening the cargo net

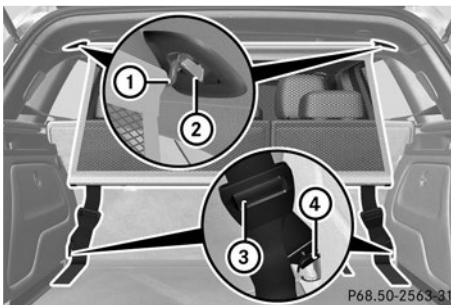

- ▶ **To attach and tighten:** insert guide rod (1) into bracket (2).
- ▶ Attach belt hook (4) to the cargo tie-down ring and pull down on the loose end of the lashing strap until the cargo net is taut.
- ▶ After driving a short distance, check the tension of the cargo net and retighten it if necessary.
- ▶ **To loosen and detach:** pull belt clamp (3) up to reduce the tension in the lashing strap.
- ▶ Unhook belt hook (4) from the cargo tie-down ring.
- ▶ Detach guide rod (1) from bracket (2).
- ▶ **To stow:** press the red button on the upper and lower guide rod.
- ▶ Fold the cargo net and roll it up.
- ▶ Close the two Velcro fasteners on the cargo net holder.

Stowage well under the cargo compartment floor

Important safety notes

WARNING

If you drive when the cargo compartment floor is open, objects could be flung around, thus striking vehicle occupants. There is a risk of injury, particularly in the event of sudden braking or a sudden change in direction. Always close the cargo compartment floor before a journey.

- ❗ The maximum load capacity of the stowage well under the cargo compartment floor is 55 lbs (25 kg).

Opening/closing the cargo compartment floor

A bracket for TIREFIT, the vehicle tool kit, etc. is located underneath the cargo compartment floor.

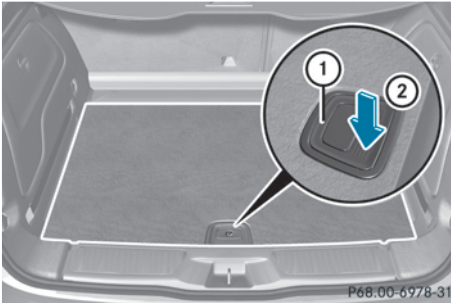

- ▶ **To open:** open the tailgate.
- ▶ Holding ribbing ②, press handle ① downwards. Handle ① folds up.
- ▶ Swing the cargo compartment floor upwards using handle ① until it rests against the cargo compartment cover.

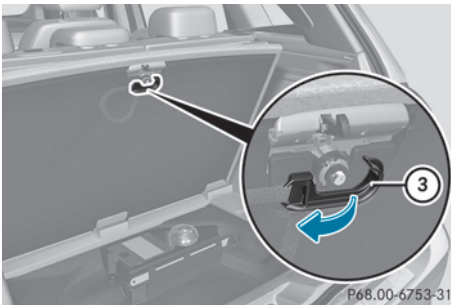

- ▶ Fold out hook ③ on the underside of the cargo compartment floor.

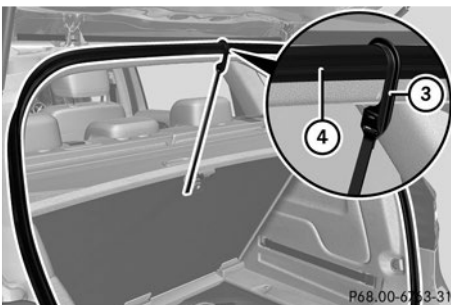

- ▶ Attach hook ③ to the cargo compartment's upper seal ④.

- ▶ **To close:** detach hook ③ from seal ④.
- ▶ Fasten hook ③ to the bracket on the underside of the cargo compartment floor.
- ▶ Fold the trunk floor down.
- ▶ Press the cargo compartment floor down until it engages.

Setting the height of the cargo compartment floor

The stowage well under the cargo compartment floor can be increased or decreased in size as necessary. To do this, you can lock the floor at two different heights. The upper catch gives a flat load surface when the rear bench seat is folded forward.

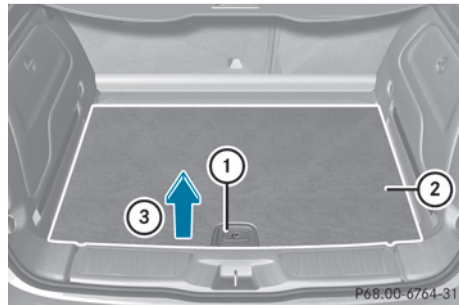

- ▶ **To raise:** using handle ①, lift up cargo compartment floor ② in the direction of arrow ③ and pull it upwards.
- ▶ Lower cargo compartment floor ② again. To do this, push the trunk floor away so that it engages in the guide on the upper level. Cargo compartment floor ② engages in the upper position.

i Carry out this step using both hands.

- ▶ **To lower:** raise cargo compartment floor ② slightly using handle ① and pull it towards you.
- ▶ Lower cargo compartment floor ② again slowly. Whilst doing so, press the trunk floor into the lower level. Cargo compartment floor ② engages in the lower position.

Roof carrier

Important safety notes

WARNING

When you load the roof, the center of gravity of the vehicle rises and the driving characteristics change. If you exceed the maximum roof load, the driving characteristics, as well as steering and braking, will be greatly impaired. There is a risk of an accident.

Never exceed the maximum roof load and adjust your driving style.

- ❗ Mercedes-Benz recommends that you only use roof carriers that have been tested and approved for Mercedes-Benz vehicles. This helps to prevent damage to the vehicle.

Position the load on the roof rack in such a way that the vehicle will not sustain damage even when it is in motion.

Ensure that, depending on the vehicle's equipment, you can raise the panorama roof with power tilt/sliding panel fully and open the tailgate fully when the roof carrier is installed.

The maximum roof load is 165 lbs((75 kg).

An incorrectly secured roof carrier or roof load may become detached from the vehicle. You must therefore ensure that you observe the roof carrier manufacturer's installation instructions.

Attaching the roof carrier

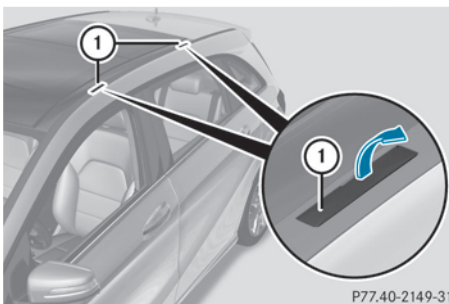

P77.40-2149-31

- ▶ Open covers ① carefully in the direction of the arrow.
- ▶ Fold covers ① upwards.
- ▶ Only secure the roof carrier to the anchorage points under covers ①.
- ▶ Observe the manufacturer's installation instructions.

Features

Cup holder

Important safety notes

WARNING

The cup holder cannot hold a container secure whilst traveling. If you use a cup holder whilst traveling, the container may be flung around and liquid may be spilled. The vehicle occupants may come into contact with the liquid and if it is hot, they may be scalded. You may be distracted from the traffic conditions and you could lose control of the vehicle. There is a risk of an accident and injury.

Only use the cup holder when the vehicle is stationary. Only use the cup holder for containers of the right size. Always close the container, particularly if the liquid is hot.

WARNING

If objects in the passenger compartment are stowed incorrectly, they can slide or be thrown around and hit vehicle occupants. There is a risk of injury, particularly in the event of sudden braking or a sudden change in direction.

- Always stow objects so that they cannot be thrown around in such situations.
- Always make sure that objects do not protrude from stowage spaces, parcel nets or stowage nets.

- Close the lockable stowage spaces while driving.
- Stow and secure objects that are heavy, hard, pointy, sharp-edged, fragile or too large in the cargo compartment.

! Only use the cup holders for containers of the right size and which have lids. The drinks could otherwise spill.

The stowage compartments in the doors provide space for bottles:

- front: capacity up to 51 fl. oz. (1.5 l)
- rear: capacity up to 17 fl. oz. (0.5 l)

Cup holder in the front-compartment center console

The cup holder and the rubber mat underneath can be removed for cleaning. Clean them with clean, lukewarm water only.

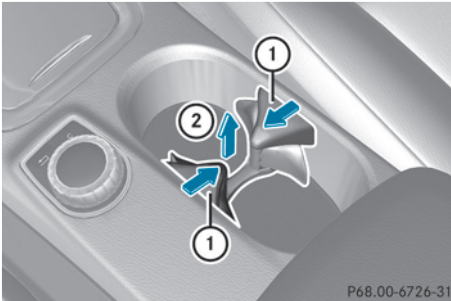

- ▶ **To remove:** carefully pull in upper sections of cup holder ① on the driver's and front-passenger sides until they release.
- ▶ Lift the cup holder upwards ② until it can be removed.

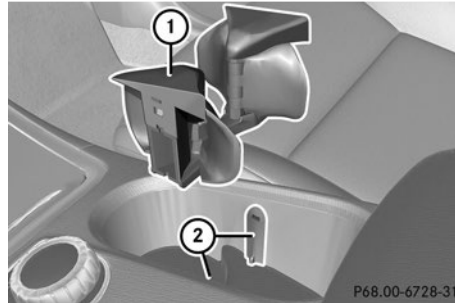

- ▶ **To install:** insert cup holder into lateral curved sections ② in the stowage compartment. Insert the cup holder so that the wedge of the upper section of cup holder ① faces forwards.
- ▶ Press the cup holder downwards until it engages on the right and left-hand sides.

Cup holder in the rear seat armrest

- !** Do not sit on or support your body weight on the rear seat armrest when it is folded down, as you could otherwise damage it.
- !** Close the cup holder before folding the rear seat armrest up. Otherwise, the cup holder could be damaged.

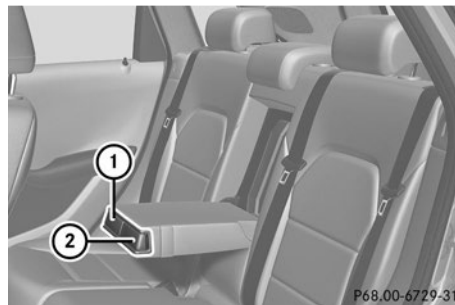

- ▶ Fold down the rear seat armrest.
- ▶ **To open:** press the front of cup holder ① or ②. Cup holder ① or ② extends automatically.
- ▶ **To close:** slide cup holder ① or ② back until it engages.

Sun visors

Overview

WARNING

If the mirror cover of the vanity mirror is folded up when the vehicle is in motion, you could be blinded by incident light. There is a risk of an accident.

Always keep the mirror cover folded down while driving.

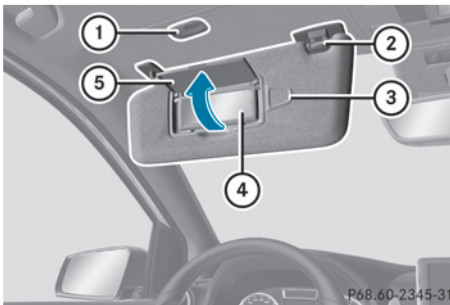

- ① Mirror light
- ② Bracket
- ③ Retaining clip, e.g. for a car park ticket
- ④ Vanity mirror
- ⑤ Mirror cover

Vanity mirror in the sun visor

Mirror light ① only functions if the sun visor is clipped into bracket ② and mirror cover ⑤ has been folded up.

Glare from the side

- ▶ Fold down the sun visor.
- ▶ Pull the sun visor out of retainer ②.
- ▶ Swing the sun visor to the side.
- ▶ **Vehicles with mirror lights:** slide the sun visor horizontally as desired.

Ashtray

Front ashtray

! The stowage space under the ashtray is not heat resistant. Before placing lit cigarettes in the ashtray, make sure that the ashtray is properly engaged. Otherwise, the stowage space could be damaged.

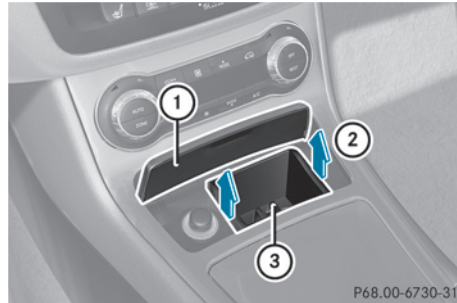

Example: vehicles with a cover over the stowage compartment

- ▶ **To open:** push the lower section of cover ①.
The stowage compartment opens.
- ▶ **To remove the insert:** lift insert ③ up ② and out.
- ▶ **To re-install the insert:** press insert ③ into the holder until it engages.

i If you remove the ashtray insert, you can use the resulting compartment for stowage.

Rear-compartment ashtray

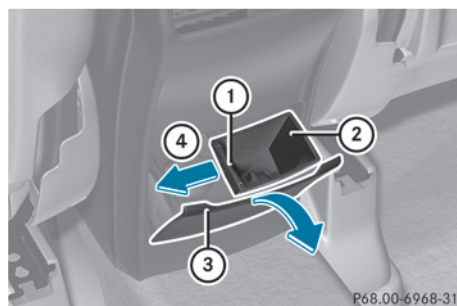

- ▶ **To open:** pull cover ③ out by its top edge.
- ▶ **To remove:** pull insert ② by recess ① in the direction of arrow ④ until it audibly releases.
- ▶ Lift insert ② up and out.
- ▶ **To install the insert:** place insert ② from above into the holder and press down until it engages.

- ▶ Turn the SmartKey to position **2** in the ignition lock (▷ page 137).
- ▶ **To open:** push the lower section of cover ①.
- ▶ The stowage compartment opens.
- ▶ Press in cigarette lighter ②.
- ▶ Cigarette lighter ② will pop out automatically when the heating element is red-hot.

Cigarette lighter

WARNING

You can burn yourself if you touch the hot heating element or the socket of the cigarette lighter.

In addition, flammable materials can ignite if:

- the hot cigarette lighter falls
- a child holds the hot cigarette lighter to objects, for example

There is a risk of fire and injury.

Always hold the cigarette lighter by the knob. Always make sure that the cigarette lighter is out of reach of children. Never leave children unsupervised in the vehicle.

Your attention must always be focused on the traffic conditions. Only use the cigarette lighter when road and traffic conditions permit.



P68.00-6734-31

Example: vehicles with a cover over the stowage compartment

12 V sockets

Points to observe before use

- ▶ Turn the SmartKey to position **1** in the ignition lock (▷ page 137).

The sockets can be used for accessories with a maximum draw of 180 W (15 A).

Accessories include such items as lamps or chargers for mobile phones.

If you use the sockets for long periods when the engine is switched off, the battery may discharge.

- i** An emergency cut-out ensures that the on-board voltage does not drop too low. If the on-board voltage is too low, the power to the sockets is automatically cut. This ensures that there is sufficient power to start the engine.

Socket in the front-compartment center console



P68.00-6736-31

Vehicles with a cover over the stowage compartment

- ▶ **To open:** push the lower section of cover ①.
The stowage compartment opens.
- ▶ Lift up the cover of socket ②.



Vehicles without a cover over the stowage compartment

- ▶ Lift up the cover of socket ①.

Socket in the rear-compartment center console

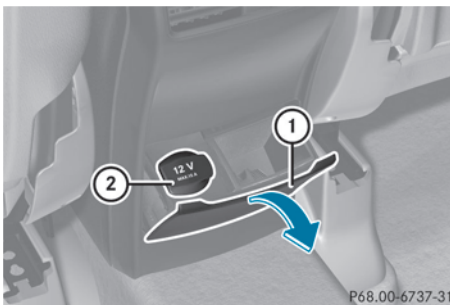

- ▶ Pull cover ① out by its top edge.
- ▶ Lift up the cover of socket ②.

Socket in the cargo compartment

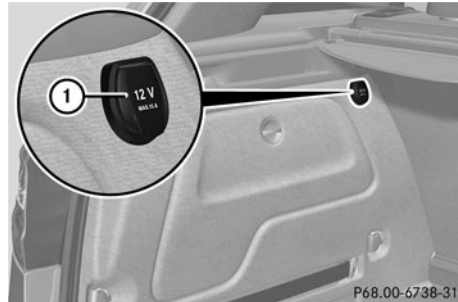

- ▶ Lift up the cover of socket ①.

mbrace

General notes

You must have a license agreement to activate the mbrace service. Make sure that your system is activated and operational. To log in, press the  MB Info call button. If any of the steps mentioned are not carried out, the system may not be activated.

If you have questions about the activation, contact the following telephone assistance service:

Customer Service at 1-888-923-8367

Shortly after successfully registering with the service, a user ID and password will be sent to you by post.

The system is available if:



- it has been activated and is operational
- the corresponding mobile phone network is available for transmitting data to the Customer Center
- a service subscription is available
- the starter battery is sufficiently charged

i Determining the location of the vehicle on a map is only possible if:

- GPS reception is available.
- the vehicle position can be forwarded to the Customer Assistance Center.

The mbrace system

To adjust the volume during a call, proceed as follows:

- ▶ Press the  or  button on the multifunction steering wheel.

or

- ▶ Use the volume controller of the audio system/COMAND.





The system offers various services, e.g:

- Automatic and manual emergency call
- Roadside Assistance call
- MB Info call

System self-test

After you have switched on the ignition, the system carries out a self-diagnosis.

A malfunction in the system has been detected if one of the following occurs:

- The indicator lamp in the SOS button does not come on during the system self-test.
- The indicator lamp in the  Roadside Assistance button does not light up during self-diagnosis of the system.
- The indicator lamp in the  MB Info call button does not light up during self-diagnosis of the system.
- The indicator lamp in one or more of the following buttons continues to light up red after the system self-diagnosis:
 - SOS button
 -  Roadside Assistance call button
 -  MB Info call button
- After the system self-diagnosis, the **Inoperative or Service Not Activated** message appears in the multifunction display.

If a malfunction is indicated as outlined above, the system may not operate as expected. In the event of an emergency, help will have to be summoned by other means.

Have the system checked at the nearest authorized Mercedes-Benz Center or call the following telephone assistance service: Customer Service at 1-888-923-8367

Emergency call

Important safety notes

WARNING

It can be dangerous to remain in the vehicle, even if you have pressed the SOS button in an emergency if:

- you see smoke inside or outside of the vehicle, e.g. if there is a fire after an accident
- the vehicle is on a dangerous section of road
- the vehicle is not visible or cannot easily be seen by other road users, particularly when dark or in poor visibility conditions

There is a risk of an accident and injury.

Leave the vehicle immediately in this or similar situations as soon as it is safe to do so. Move to a safe location along with other vehicle occupants. In such situations, secure the vehicle in accordance with national regulations, e.g. with a warning triangle.

You must have a license agreement to activate the mbrace service. Make sure that your system is activated and operational. To register, press the  MB Info call button. If any of the steps mentioned are not carried out, the system may not be activated.

If you have questions about the activation, contact the following telephone assistance service:

Customer Service at 1-888-923-8367

General notes

An emergency call is dialed automatically if an air bag or Emergency Tensioning Device is triggered.

-  You cannot end an automatically triggered emergency call yourself.

An emergency call can also be initiated manually.

As soon as the emergency call has been initiated, the indicator lamp in the SOS button flashes. The multifunction display shows the **Connecting Call** message.

The audio output is muted.

Once the connection has been made, the **Call Connected** message appears in the multifunction display.

All important information on the emergency is transmitted, for example:

- Current location of the vehicle (as determined by the GPS system)
- Vehicle identification number
- Information on the severity of the accident

Shortly after the emergency call has been initiated, a voice connection is automatically established between the Customer Assistance Center and the vehicle occupants.

- If the vehicle occupants respond, the Mercedes-Benz Customer Assistance Center attempts to get more information on the emergency.
- If there is no response from the vehicle occupants, an ambulance is immediately sent to the vehicle.

If no voice connection can be established to the Mercedes-Benz Customer Assistance Center, the system has been unable to initiate an emergency call.

This can occur, for example, if the relevant mobile phone network is not available. The indicator lamp in the SOS button flashes continuously.

The **Call Failed** message appears in the multifunction display and must be confirmed.

In this case, summon assistance by other means.

Making an emergency call

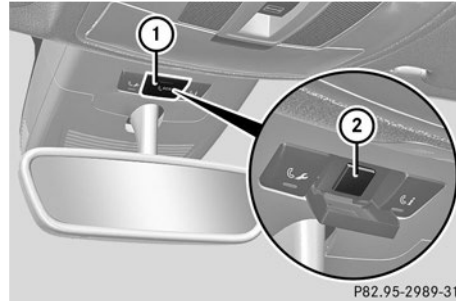

- ▶ **To initiate an emergency call manually:** press cover ① briefly to open.
- ▶ Press SOS button ② briefly. The indicator lamp in SOS button ② flashes until the emergency call is concluded.
- ▶ Wait for a voice connection to the Mercedes-Benz Customer Assistance Center.
- ▶ After the emergency call, close cover ①.

- ❗ If the mobile phone network is unavailable, mbrace will not be able to make the emergency call. If you leave the vehicle immediately after pressing the SOS button, you will not know whether mbrace placed the emergency call. In this case, always summon assistance by other means.

Roadside Assistance button

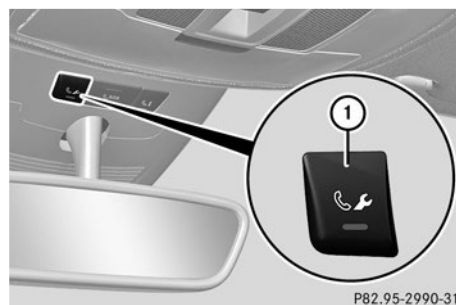

- ▶ Press Roadside Assistance button ①. This initiates a call to the Mercedes-Benz Customer Assistance Center. The indicator lamp in Roadside Assistance button ① flashes while the call is active. The multifunction display shows the **Connecting Call** message. The audio output is muted.

If a connection can be made, the **Call Connected** message appears in the multifunction display.

If a mobile phone network and GPS reception are available, the system transfers data to the Mercedes-Benz Customer Assistance Center, for example:

- Current location of the vehicle
- Vehicle identification number

- ❗ The audio system or COMAND display indicates that a call is active. During the call, you can change to the navigation menu by pressing the NAVI button on COMAND, for example.

Voice output is not available.

A voice connection is established between the Mercedes-Benz Customer Assistance Center and the vehicle occupants.

From the vehicle remote malfunction diagnosis, the Mercedes-Benz Customer Assistance Center can ascertain the nature of the problem (▷ page 271).

The Mercedes-Benz Customer Assistance Center either sends a qualified Mercedes-Benz technician or makes arrangements for your vehicle to be transported to the nearest authorized Mercedes-Benz Center.

You may be charged for services such as repair work and/or towing.

Further details are available in your mbrace manual.

- ❗ The system has not been able to initiate a roadside assistance call, if:

- the indicator lamp for Roadside Assistance call button ① is flashing continuously.
- no voice connection to the Mercedes-Benz Customer Assistance Center was established.

This can occur if the relevant mobile phone network is not available, for example.

The **Call Failed** message appears in the multifunction display.

- ▶ **To end a call:** press the  button on the multifunction steering wheel.

or

- ▶ Press the corresponding button for ending a phone call on the audio system or on COMAND.

MB Info call button

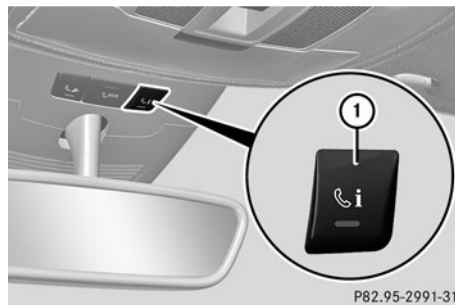

- ▶ Press MB Info call button ①. This initiates a call to the Mercedes-Benz Customer Assistance Center. The indicator lamp in MB Info call button ① flashes while the connection is being made. The multifunction display shows the **Connecting Call** message. The audio system is muted.

If a connection can be made, the **Call Connected** message appears in the multifunction display.

If a mobile phone network and GPS reception are available, the system transfers data to the Mercedes-Benz Customer Assistance Center, for example:

- Current location of the vehicle
- Vehicle identification number

i The audio system or COMAND display indicates that a call is active. During the call, you can change to the navigation menu by pressing the NAVI button on COMAND, for example.

Voice output is not available.

A voice connection is established between the Mercedes-Benz Customer Assistance Center and the vehicle occupants.

You receive information about operating your vehicle, about the nearest authorized Mercedes-Benz Center and about other products and services from Mercedes-Benz.

i The system has not been able to initiate an MB Info call, if:

- the indicator lamp in MB Info call button  is flashing continuously.
- no voice connection to the Mercedes-Benz Customer Assistance Center was established.

This can occur if the relevant mobile phone network is not available, for example.

The **Call Failed** message appears in the multifunction display.

► **To end a call:** press the  button on the multifunction steering wheel.

or

► Press the corresponding button for ending a phone call on the audio system or on COMAND.

Call priority

When service calls are active, e.g. Roadside Assistance or MB Info calls, an emergency call can still be initiated. In this case, an emergency call will take priority and override all other active calls.

The indicator lamp of the respective button flashes until the call is ended.

An emergency call can only be terminated by the Mercedes-Benz Customer Assistance Center.

All other calls can be ended by pressing:

- the  button on the multifunction steering wheel
- the corresponding button on the audio system or on COMAND for ending a telephone call

i When a call is initiated, the audio system is muted. The mobile phone is no longer connected to COMAND. However, if you want to use your mobile phone, do so only when the vehicle is stationary and in a safe location.

Downloading destinations in COMAND

Downloading destinations

Destination Download gives you access to a data bank with over 15 million Points of Interest (POIs). These can be downloaded on the navigation system in your vehicle. If you know the destination, the address can be downloaded. Alternatively, you can obtain the location of Points of Interest (POIs)/ important destinations in the vicinity.

Furthermore, you can download routes with up to 20 way points.

You are prompted to confirm route guidance to the address entered.

The system calculates the route and subsequently starts the route guidance with the address entered.

i If you select **No**, the address can be saved in the address book.

i The destination download function is available if the relevant mobile phone network is available and data transfer is possible.

- i** The destination download function can only be used if the vehicle is equipped with a navigation system.

Route Assistance

This service is part of the mbrace PLUS Package and cannot be purchased separately.

- i** You can also use the Route Assistance function if your vehicle is not equipped with a navigation system.

Within the framework of this service, you receive a professional and reliable form of navigation support without having to leave your vehicle.

The customer service representative finds a suitable route depending on your vehicle's current position and the desired destination. You will then be guided live through the current route section.

Search & Send

General notes

- i** To use "Search & Send", your vehicle must be equipped with mbrace and a navigation system. Additionally, an mbrace service subscription must be completed.

"Search & Send" is a destination entry service. A destination address which is found on Google Maps® can be transferred via mbrace directly to your vehicle's navigation system.

Specifying and sending the destination address

- ▶ Go to the website <http://www.maps.google.com> and enter a destination address into the entry field.
- ▶ **To send the destination address to the e-mail address of your mbrace account:** click on the corresponding button on the website.

- i** Example:

If you select 'Send to vehicle' and then 'Mercedes-Benz', the destination address will be sent to your vehicle.

- ▶ When the "Send" dialog window appears:
 - Enter the e-mail address you specified when setting up your mbrace account into the corresponding field.
- ▶ Click "Send".

- i** Information on specific commands such as "Address entry" or "Send" can be found on the website.

Calling up destination addresses

- ▶ Switch on the ignition.
 - The destination address is loaded into the vehicle's navigation system.
 - A display message appears, asking whether navigation should be started.
- ▶ Select **Yes** by turning **ⓘ** or sliding **←→** the COMAND controller and press **ⓘ** to confirm.
 - The system calculates the route and subsequently starts the route guidance with the address entered.

- i** If you select **No**, the address can be saved in the address book.

- i** If you have sent more than one destination address, each individual destination must be confirmed separately.

- i** Destination addresses are loaded in the same order as the order in which they were sent.

If you own multiple Mercedes-Benz vehicles with mbrace and activated mbrace accounts:

If multiple vehicles are registered under the same e-mail address, the destination will be sent to all the vehicles.

Vehicle remote opening

You can use the vehicle remote opening if you have unintentionally locked your vehicle and a replacement SmartKey is not available.

The vehicle can be opened by the Mercedes-Benz Customer Assistance Center.

The vehicle can be immediately opened remotely within four days of the ignition being turned off. After this time, the remote unlocking may be delayed by 15 to 60 minutes. After 30 days, the vehicle can no longer be opened remotely.

- ▶ Contact the following telephone assistance service:
Customer Service at 1-888-923-8367
You will be asked for your password.
- ▶ Return to your vehicle at the time agreed upon with the Mercedes-Benz Customer Assistance Center.

To do this, you will need your identification number and password.

- i** Vehicle remote opening is only possible if the corresponding mobile phone network is accessible.

Vehicle remote closing

The remote closing feature can be used when you have forgotten to lock the vehicle and you are no longer nearby.

The vehicle can then be locked by the Mercedes-Benz Customer Assistance Center.

The vehicle can be immediately remotely locked within four days of the ignition being turned off. After this time, the remote closing may be delayed by 15 to 60 minutes. After 30 days the vehicle can no longer be closed remotely.

- ▶ Contact the following telephone assistance service:
Customer Service at 1-888-923-8367
You will be asked for your password.

The next time you are inside the vehicle and you switch on the ignition, the **Doors Locked Remotely** message appears in the multifunction display.

To do this, you will need your identification number and password.

- i** The vehicle remote closing feature is available when the relevant mobile phone network is available and data connection is possible.

Stolen vehicle recovery service

If your vehicle has been stolen:

- ▶ Notify the police.
The police will issue a numbered incident report.
- ▶ This number will be forwarded to the Mercedes-Benz Customer Assistance Center together with your PIN.
The Mercedes-Benz Customer Assistance Center then tries to locate the system. The Mercedes-Benz Customer Assistance Center contacts you and the local law enforcement agency if the vehicle is located.

However, only the law enforcement agency is informed of the location of the vehicle.

- i** If the anti-theft alarm system is activated for longer than 30 seconds, the Mercedes-Benz Customer Assistance Center is automatically informed.

Vehicle remote malfunction diagnosis

With the vehicle remote malfunction diagnosis (Vehicle Health Check), the Customer Assistance center can provide improved support for problems with your vehicle. During an existing call, vehicle data is transferred to the Customer Assistance center. The customer service representative can use the received data to decide what kind of assistance is required. You are then, for example, guided to the nearest authorized Mercedes-Benz Center or a recovery vehicle is called.

If vehicle data needs to be transferred during an MB Info call or a Roadside Assistance call, this is initiated by the Customer Assistance center. You will see the **Roadside Assistance Connected** message in the COMAND display. If the vehicle remote

malfunction diagnosis can be started, the **Request for vehicle diagnosis received. Start vehicle diagnosis?** message appears in the display.

- ▶ Confirm the message with **Yes**.
- ▶ When the **Vehicle Diagnosis Please start ignition** message appears, turn the SmartKey to position **2** in the ignition lock (▷ page 137).
- ▶ When the **Please follow the instructions received by phone and move your vehicle to a safe position.** message appears, follow the customer service representative's instructions.

The message in the display disappears.

If you select **Cancel**, the vehicle remote malfunction diagnosis is canceled completely.

The vehicle operating state check begins.

You will see the **Vehicle diagnosis activated.** message.

When the diagnosis is completed, the **Send vehicle diagnostics data/(Voice connection may be/interrupted during data transfer)** message appears. The vehicle data can now be sent to the Customer Assistance center.

- ▶ Press **OK** to confirm the message. The voice connection with the Customer Assistance center is terminated. You will see the **Vehicle Diagnosis: Transferring data...** message. The vehicle data is sent to the Customer Assistance center.

Depending on what the customer service representative agreed with you, the voice connection is re-established after the transfer is complete. If necessary, you will be contacted at a later time by another means, e.g. by e-mail or phone.

Further functions of the vehicle remote malfunction diagnosis include, for example:

- transfer of service data to the Customer Assistance center. If a service is overdue,

the COMAND display shows a message about various special offers at your workshop.

- monthly status information e-mail on oil level, air pressure, maintenance, brakes, etc. If applicable, you will receive information on special offers in the e-mail.

Information on the data stored in the vehicle (▷ page 26).

Information on Roadside Assistance (▷ page 23).

Downloading routes

Downloading routes allows you to transfer and save predefined routes in the navigation system. To do this, an SD memory card must be inserted into the COMAND system. If no SD memory card is inserted, you must insert the card into the card slot on the COMAND system before saving.

A route can be prepared and sent either by a customer service representative or via the mbrace portal on the Internet.

Each route can include up to 20 way points. Once a route has been received by the navigation system, you will see the **<route name> has been saved to memory card. Do you want to start route guidance?** message in the COMAND display. The route is saved to the SD memory card.

- ▶ **To start route guidance:** select **Yes**. An overview of the route is shown in the display.
- ▶ **To start route guidance:** select **Yes**. An overview of the route is shown in the display.

- ▶ **To start route guidance:** select **Yes**. An overview of the route is shown in the display.
- ▶ **To start route guidance:** select **Yes**. An overview of the route is shown in the display.

- ▶ **To start route guidance:** select **Yes**. An overview of the route is shown in the display.
- ▶ **To start route guidance:** select **Yes**. An overview of the route is shown in the display.

Speed alert

You can define the upper speed limit, which must not be exceeded by the vehicle.

If this selected speed is exceeded by the vehicle, a message will be sent to the Customer Assistance center. The Customer Assistance center then forwards this information to you.

You can select the way in which you receive this information beforehand. Possible options include text message, e-mail or an automated call.

The data you receive contains the following information:

- the location where the speed limit was exceeded
- the time at which the speed limit was exceeded
- the selected speed limit which was exceeded

Geo fencing

Geo fencing allows you to select areas which the vehicle should not enter or leave. You will be informed if the vehicle crosses the boundaries of the selected areas. You can select the way in which you receive this information beforehand. Possible options include text message, e-mail or an automated call.

The area can be determined as either a circle or a polygon with a maximum of ten corners. You can specify up to ten areas simultaneously. Different settings are possible for each area.

Alternatively, you can trigger an MB Info call and inform the customer service representative that you wish to activate geo fencing.

Currently inactive areas can be activated by text message.

Triggering the vehicle alarm

With this function, you can trigger the vehicle's panic alarm via text message. An alarm sounds and the exterior lighting flashes. Depending on the setting, the panic alarm lasts five or ten seconds. Afterwards, the alarm switches off.

Garage door opener

Important safety notes

WARNING

When you operate or program the garage door with the integrated garage door opener, persons in the range of movement of the garage door can become trapped or struck by the garage door. There is a risk of injury.

When using the integrated garage door opener, always make sure that nobody is within the range of movement of the garage door.

WARNING

Combustion engines emit poisonous exhaust gases such as carbon monoxide. Inhaling these exhaust gases leads to poisoning. There is a risk of fatal injury. Therefore never leave the engine running in enclosed spaces without sufficient ventilation.

The HomeLink® garage door opener integrated in the rear-view mirror allows you to operate up to three different door and gate systems.

Use the integrated garage door opener only on garage doors that:

- have safety stop and reverse features and
- meet current U.S. federal safety standards

When programming a garage door opener, park the vehicle outside the garage.

-  Certain garage door drives are incompatible with the integrated garage door opener. If you have difficulty programming the integrated garage door

opener, contact an authorized Mercedes-Benz Center.

Alternatively, you can call the following telephone assistance services:

- **USA:** Mercedes-Benz Customer Assistance Center at 1-800-FOR-MERCEdes
- **Canada:** Customer Service at 1-800-387-0100
- HomeLink® hotline 1-800-355-3515 (free of charge)

More information on HomeLink® and/or compatible products is also available online at <http://www.homelink.com>.

- ❗ Notes on the declaration of conformity (▷ page 24).

USA: FCC ID: CB2HMIHL4

Canada: IC: 279B-HMIHL4

Programming

Programming buttons

Observe the "Important safety notes" (▷ page 273).

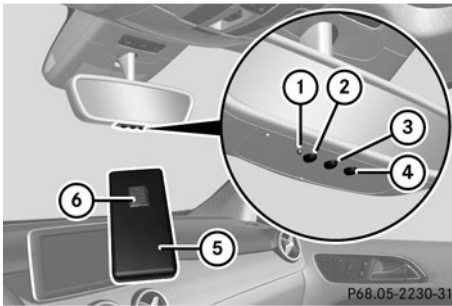

Integrated garage door opener in the rear-view mirror

Garage door remote control ⑤ is not part of the integrated garage door opener.

- ▶ The first time before programming, clear the integrated garage door opener memory (▷ page 276).
- ▶ Turn the SmartKey to position **2** in the ignition lock.

- ▶ Press and hold one of buttons ② to ④ on the integrated garage door opener. After a short time, indicator lamp ① lights up yellow.

- ❗ Indicator lamp ① lights up yellow as soon as button ②, ③ or ④ is programmed for the first time. If the selected button has already been programmed, indicator lamp ① will only light up yellow after ten seconds have elapsed.

- ▶ Release button ②, ③ or ④. Indicator lamp ① flashes yellow.

- ▶ Point garage door remote control ⑤ towards buttons ② to ④ on the rear-view mirror at a distance of 2 to 8 inches (5 to 20 cm).

- ❗ The required distance between remote control ⑤ and the integrated garage door opener depends on the garage door drive system. Several attempts might be necessary. You should test every position for at least 25 seconds before trying another position.

- ▶ Press and hold button ⑥ on remote control ⑤ until indicator lamp ① lights up green. If indicator lamp ① lights up green or flashes, then programming has been successful.

- ▶ Release button ⑥ on remote control ⑤ for the garage door drive system.

- ▶ If indicator lamp ① lights up red: repeat the programming procedure for the corresponding button on the rear-view mirror. When doing so, vary the distance between remote control ⑤ and the rear-view mirror.

- ❗ If the indicator lamp flashes green after successful programming, the garage door system is using a rolling code. After programming, you must synchronize the garage door opener integrated in the rear-view mirror with the receiver of the garage door system.

Synchronizing the rolling code

Observe the "Important safety notes" (▷ page 273).

Your vehicle must be within reach of the garage door or exterior gate drive. Make sure that neither your vehicle nor any persons/objects are present within the sweep of the door or gate.

- ▶ Turn the SmartKey to position **2** in the ignition lock.
- ▶ Press the program button of the door or gate drive (see the door or gate drive operating instructions, e.g. under "programming of additional remote controls").
- i** Usually, you now have 30seconds to initiate the next step.
- ▶ Press previously programmed button **②**, **③** or **④** of the integrated garage door opener until the door closes. The rolling code synchronization is then complete.

Notes on programming the remote control

Canadian radio frequency laws require a "break" (or interruption) of the transmission signals after broadcasting for a few seconds. Therefore, these signals may not last long enough for the integrated garage door opener. The signal is not recognized during programming. Comparable with Canadian law, some U.S. garage door openers also feature a "break".

Proceed as follows:

- if you live in Canada
- if you have difficulties programming the garage door opener (regardless of where you live) when using the programming steps
- ▶ Press and hold one of buttons **②** to **④** on the integrated garage door opener. After a short time, indicator lamp **①** lights up yellow.
- ▶ Release the button. Indicator lamp **①** flashes yellow.
- ▶ Press button **⑥** of garage door remote control **⑤** for two seconds, then release it for two seconds.
- ▶ Press button **⑥** again for two seconds.
- ▶ Repeat this sequence on button **⑥** of remote control **⑤** until indicator lamp **①** lights up green. If indicator lamp **①** turns red, repeat the process.
- ▶ Continue with the other programming steps (see above).

Problems when programming

If you are experiencing problems programming the integrated garage door opener on the rear-view mirror, take note of the following instructions:

- Check the transmitter frequency of garage door drive remote control **⑤**. This can usually be found on the back of the remote control. The integrated garage door opener is compatible with devices that have units which operate in the frequency range of 280to 433MHz.
- Replace the batteries in garage door remote control **⑤**. This increases the likelihood that garage door remote control **⑤** will transmit a strong and precise signal to the integrated garage door opener in the rear-view mirror.
- When programming, hold remote control **⑤** at varying distances and angles from the button that you are programming. Try various angles at a distance between 2and 12 inches (5to 30 cm) or at the same angle but at varying distances.
- If another remote control for the same garage door drive is available, repeat the

same programming steps with this remote control. Before performing these steps, make sure that new batteries have been installed in garage door drive remote control ⑤.

- Note that some remote controls only transmit for a limited amount of time (the indicator lamp on the remote control goes out). Press button ⑥ on remote control ⑤ again before transmission ends.
- Align the antenna cable of the garage door opener unit. This can improve signal reception/transmission.

Opening/closing the garage door

After it has been programmed, the integrated garage door opener performs the function of the garage door system remote control. Please also read the operating instructions for the garage door system.

- ▶ Turn the SmartKey to position **2** in the ignition lock.
- ▶ Press button ②, ③ or ④ which you have programmed to operate the garage door. Garage door system with a fixed code: indicator lamp ① lights up green. Garage door system with a rolling code: indicator lamp ① flashes green.

i The transmitter will transmit a signal as long as the button is pressed. The transmission is halted after a maximum of ten seconds and indicator lamp ① lights up yellow. Press button ②, ③ or ④ again if necessary.

Clearing the memory

- ▶ Turn the SmartKey to position **2** in the ignition lock.
- ▶ Press buttons ② and ④. The indicator lamp lights up yellow.
- ▶ Press and hold buttons ② and ④ until the indicator lamp turns green.

i Make sure that you clear the memory of the integrated garage door opener before selling the vehicle.

Compass

Calling up the compass

The compass displays in which compass direction the vehicle is currently traveling: **N, NE, E, SE, S, SW, W or NW.**

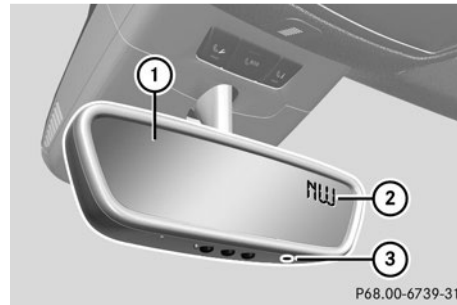

P68.00-6739-31

To receive a correct display in rear-view mirror ①, the compass must be calibrated and the magnetic field zone set.

Setting the compass

- ▶ Determine your position using the following zone maps.

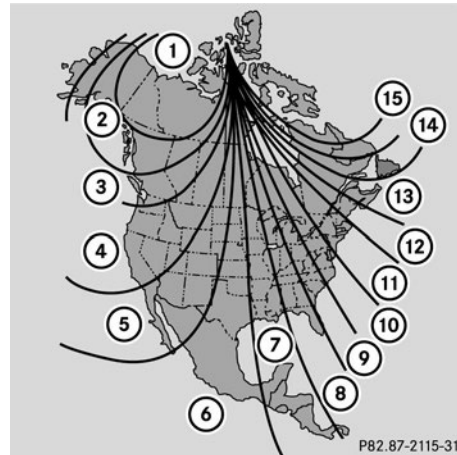

P82.87-2115-31

North America zone map

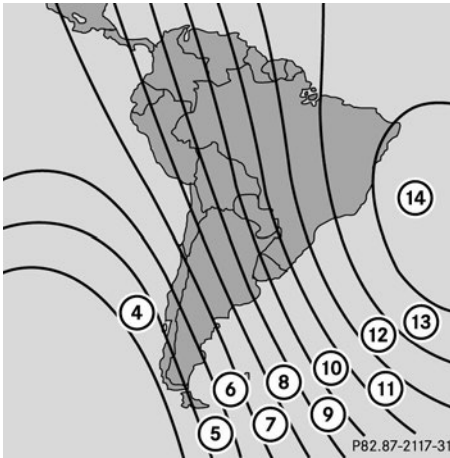

South America zone map

- ▶ Push a round pen into opening ③ (▷ page 276) for approximately three seconds. The zone currently selected appears in compass display ② (▷ page 276).
- ▶ **To select the zone:** push a round pen into opening ③ (▷ page 276) until the desired zone is selected. If, after a few seconds, the display in compass display ② (▷ page 276) changes direction, the zone has been selected.

Calibrating the compass

- ▶ Make sure that there is sufficient space for you to drive in a circle without impeding traffic.

In order to calibrate the compass correctly, do the following:

- calibrate the compass in the open and not in the vicinity of steel structures or high-voltage transmission lines.
- switch off electrical consumers such as the climate control, windshield wipers or rear window defroster.
- close all doors and the tailgate.
- ▶ Switch on the ignition.
- ▶ Push a round pen into opening ③ (▷ page 276) for approximately six

seconds, until symbol C is shown in compass display ② (▷ page 276).

- ▶ Drive your vehicle in a full circle at approximately 3 mph (5 km/h) to 6 mph (10 km/h). When the calibration has successfully been completed, the current direction is shown in compass display ② (▷ page 276).

Floormat on the driver's side

⚠ WARNING

Objects in the driver's footwell can restrict the pedal travel or obstruct a depressed pedal. The operating and road safety of the vehicle is jeopardized. There is a risk of an accident.

Make sure that all objects in the vehicle are stowed correctly, and that they cannot enter the driver's footwell. Install the floormats securely and as specified in order to ensure sufficient clearance for the pedals. Do not use loose floormats and do not place floormats on top of one another.

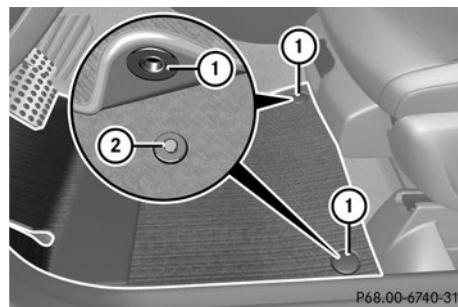

- ▶ Slide the seat backwards.
- ▶ **To install:** place the floormat in the footwell.
- ▶ Press safety catch knobs ① onto retainers ②.
- ▶ **To remove:** pull the floormat off retainers ②.
- ▶ Remove the floormat.

Useful information	280
Engine compartment	280
Maintenance	284
Care	285

Useful information

- i** This Operator's Manual describes all models and all standard and optional equipment of your vehicle available at the time of publication of the Operator's Manual. Country-specific differences are possible. Please note that your vehicle may not be equipped with all features described. This also applies to safety-related systems and functions.
- i** Read the information on qualified specialist workshops: (▷ page 25).

Engine compartment

Hood

Important safety notes

WARNING

If the hood is unlatched, it may open up when the vehicle is in motion and block your view. There is a risk of an accident.
Never unlatch the hood while driving.

WARNING

When opening and closing the hood, it may suddenly fall into the closed position. There is a risk of injury to persons within range of movement of the hood.
Open and close the hood only when no one is within its range of movement.

WARNING

Opening the hood when the engine is overheated or when there is a fire in the engine compartment could expose you to hot gases or other service products. There is a risk of injury.

Let an overheated engine cool down before opening the hood. If there is a fire in the engine compartment, keep the hood closed and contact the fire department.

WARNING

The engine compartment contains moving components. Certain components, such as the radiator fan, may continue to run or start again suddenly when the ignition is off. There is a risk of injury.

If you need to do any work inside the engine compartment,

- switch off the ignition
- never reach into the area where there is a risk of danger from moving components, such as the fan rotation area
- keep clothing away from moving parts

WARNING

The ignition system and the fuel injection system work under high voltage. If you touch components which are under voltage, you could get an electric shock. There is a risk of injury.

Never touch components of the ignition system or fuel injection system when the ignition is switched on.

Opening the hood

WARNING

Certain components in the engine compartment, such as the engine, radiator and parts of the exhaust system, can become very hot. Working in the engine compartment poses a risk of injury.

Where possible, let the engine cool down and touch only the components described in the following.

WARNING

When the hood is open and the windshield wipers are set in motion, you can be injured by the wiper linkage. There is a risk of injury.
Always switch off the windshield wipers and the ignition before opening the hood.

- !** Make sure that the windshield wipers are not folded away from the windshield. You

could otherwise damage the windshield wipers or the hood.



P88.40-2936-31

- ▶ Make sure that the windshield wipers are switched off.
- ▶ Pull release lever ① on the hood. The hood is released.



P88.40-2937-31

- ▶ Reach into the gap between the hood and the radiator trim and press hood catch lever ② to the left.
- ▶ Raise the hood.

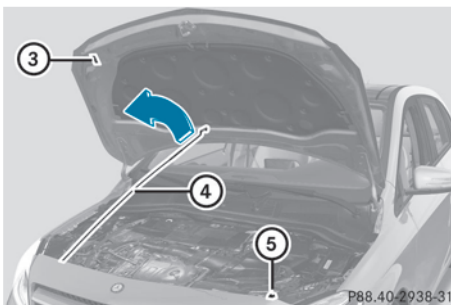

P88.40-2938-31

- ▶ Pull support strut ④ out of bracket ⑤.
- ▶ Lift up support strut ④ and insert it into yellow retaining clip ③.

Closing the hood

- ▶ Raise the hood slightly and, at the same time, remove support strut ④ from yellow retaining clip ③.
- ▶ Swing support strut ④ down and press it into bracket ⑤ until it engages.
- ▶ Lower the hood and let it fall from a height of approximately 8 in (20 cm).
- ▶ Check that the hood has engaged properly. If the hood can be raised slightly, it is not properly engaged. Do not press the hood closed. Open the hood again and close it with a little more force.

Engine oil

General notes

Depending on your driving style, the vehicle consumes up to 0.9 US qt (0.8 liters) of oil per 600 miles (1,000 km). The oil consumption may be higher than this when the vehicle is new or if you frequently drive at high engine speeds.

Depending on the engine, the oil dipstick may be in a different location.

When checking the oil level:

- park the vehicle on a level surface.
- the engine should be switched off for approximately five minutes if the engine is at normal operating temperature.
- if the engine is not at normal operating temperature, e.g. if the engine was only started briefly, wait about 30 minutes before carrying out the measurement.

Checking the oil level using the oil dipstick

WARNING

Certain components in the engine compartment, such as the engine, radiator and parts of the exhaust system, can become very hot. Working in the engine compartment poses a risk of injury.

Where possible, let the engine cool down and touch only the components described in the following.

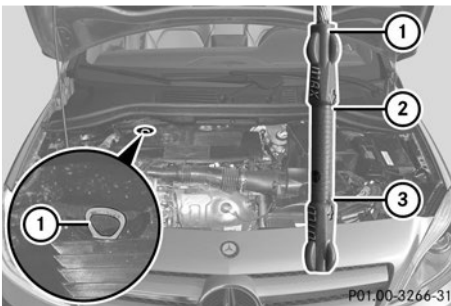

Example

- ▶ Pull oil dipstick ① out of the dipstick guide tube.
- ▶ Wipe off oil dipstick ①.
- ▶ Slowly slide oil dipstick ① into the guide tube to the stop, and take it out again. If the level is between MIN mark ③ and MAX mark ②, the oil level is correct.
- ▶ If the oil level has dropped to MIN mark ③ or below, add 1.1 US qt (1.0 liter) of engine oil.

Adding engine oil

WARNING

Certain components in the engine compartment, such as the engine, radiator and parts of the exhaust system, can become very hot. Working in the engine compartment poses a risk of injury.

Where possible, let the engine cool down and touch only the components described in the following.

WARNING

If engine oil comes into contact with hot components in the engine compartment, it may ignite. There is a risk of fire and injury.

Make sure that engine oil is not spilled next to the filler neck. Let the engine cool down and thoroughly clean the engine oil off the components before starting the engine.

Environmental note

When adding oil, take care not to spill any. If oil enters the soil or waterways, it is harmful to the environment.

- ❗ Only use engine oils and oil filters that have been approved for vehicles with a service system. You can obtain a list of the engine oils and oil filters tested and approved in accordance with the Mercedes-Benz Specifications for Service Products at any Mercedes-Benz Service center.

Damage to the engine or exhaust system is caused by the following:

- using engine oils and oil filters that have not been specifically approved for the service system
 - replacing engine oil and oil filters after the interval for replacement specified by the service system has been exceeded
 - using engine oil additives.
- ❗ Do not add too much oil. adding too much engine oil can result in damage to the engine or to the catalytic converter. Have excess engine oil siphoned off.

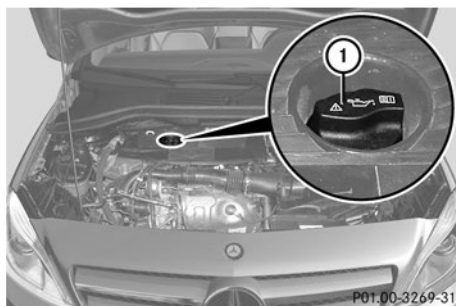

Example: engine oil cap

- ▶ Turn cap ① counter-clockwise and remove it.
- ▶ Add engine oil.
If the oil level is at or below the MIN mark on the oil dipstick, add 1.1 US qt (1.0 liter) of engine oil.
- ▶ Replace cap ① on the filler neck and turn clockwise.
Ensure that the cap locks into place securely.
- ▶ Check the oil level again with the oil dipstick (▷ page 282).

Further information on engine oil (▷ page 349).

Checking and adding other service products

Checking coolant level

WARNING

The engine cooling system is pressurized, particularly when the engine is warm. When opening the cap, you could be scalded by hot coolant spraying out. There is a risk of injury. Let the engine cool down before opening the cap. Wear eye and hand protection when opening the cap. Open the cap slowly half a turn to allow pressure to escape.

- ❗ The coolant may only be checked and corrected when the engine is cool (coolant temperature below 104 °F (40 °C)).
Checking the coolant when the coolant

temperature is above 104 °F (40 °C) may result in damage to the engine or to the engine cooling system.

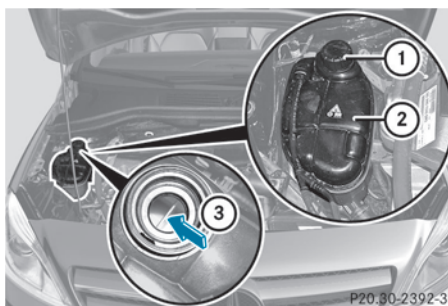

Example

- ▶ Park the vehicle on a level surface.
Only check the coolant level when the vehicle is on a level surface and the engine has cooled down.
- ▶ Turn the SmartKey to position 2 in the ignition lock (▷ page 137).
- ▶ Check the coolant temperature display in the instrument cluster.
The coolant temperature must be below 104 °F (40 °C).
- ▶ Turn the SmartKey to position 0 (▷ page 137) in the ignition lock.
- ▶ Slowly turn cap ① half a turn counter-clockwise to allow excess pressure to escape.
- ▶ Turn cap ① further counter-clockwise and remove it.
If the coolant is at the level of marker bar ③ in the filler neck when cold, there is enough coolant in coolant expansion tank ②.
- ▶ If necessary, add coolant that has been tested and approved by Mercedes-Benz.
- ▶ Replace cap ① and turn it clockwise as far as it will go.

For further information on coolant, see (▷ page 351).

Windshield washer system

WARNING

Certain components in the engine compartment, such as the engine, radiator and parts of the exhaust system, can become very hot. Working in the engine compartment poses a risk of injury.

Where possible, let the engine cool down and touch only the components described in the following.

WARNING

Windshield washer concentrate is highly flammable. If it comes into contact with hot engine components or the exhaust system it could ignite. There is a risk of fire and injury. Make sure that no windshield washer concentrate is spilled next to the filler neck.

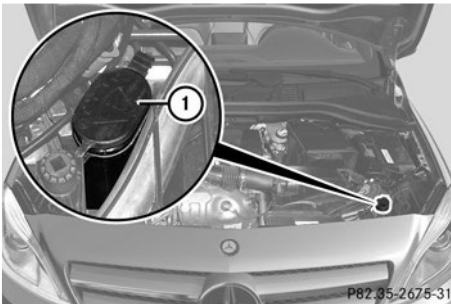

Example

- ▶ **To open:** pull cap ① upwards by the tab.
- ▶ Add the premixed washer fluid.
- ▶ **To close:** press cap ① onto the filler neck until it engages.

If the washer fluid level drops below the recommended minimum of 1 liter, a message appears in the multifunction display prompting you to refill the washer fluid (▷ page 236).

Further information on windshield washer fluid/antifreeze (▷ page 352).

Maintenance

ASSYST PLUS

Service messages

The ASSYST PLUS service interval display informs you of the next service due date. Information on the type of service and service intervals (see the separate Maintenance Booklet).

You can obtain further information from an authorized Mercedes-Benz Center or at <http://www.mbusa.com> (USA only).

-  The ASSYST PLUS service interval display does not show any information on the engine oil level. Observe the notes on the engine oil level (▷ page 281).

The multifunction display shows a service message for several seconds, e.g.:

- Service A in .. Days
- Service A Due
- Service A Exceeded by .. Days

Depending on the operating conditions of the vehicle, the remaining time or distance until the next service due date is displayed.

The letter **A** or **B**, possibly in connection with a number or another letter, shows the type of service. **A** stands for a minor service and **B** for a major service.

You can obtain further information from an authorized Mercedes-Benz Center.

The ASSYST PLUS service interval display does not take into account any periods of time during which the battery is disconnected.



Maintaining the time-dependent service schedule:

- ▶ Note down the service due date displayed in the multifunction display before disconnecting the battery.





or

- ▶ After reconnecting the battery, subtract the battery disconnection periods from the service date shown on the display.

Hiding a service message

- ▶ Press the  or  button on the steering wheel.

Displaying service messages

- ▶ Switch on the ignition.
- ▶ Press the  or  button to select the **Serv.** menu.
- ▶ Press the  or  button to select the **ASSYST PLUS** submenu and confirm by pressing the  button.
The service due date appears in the multifunction display.

Information about Service

Resetting the ASSYST PLUS service interval display

- ❗ If the ASSYST PLUS service interval display has been inadvertently reset, this setting can be corrected at a qualified specialist workshop.

Have service work carried out as described in the Maintenance Booklet. This may otherwise lead to increased wear and damage to the major assemblies or the vehicle.

A qualified specialist workshop, e.g. an authorized Mercedes-Benz Center, will reset the ASSYST PLUS service interval display after the service work has been carried out. You can also obtain further information on maintenance work, for example.

Special service requirements

The specified maintenance interval takes only the normal operation of the vehicle into account. Under arduous operating conditions or increased load on the vehicle, maintenance work must be carried out more frequently, for example:

- regular city driving with frequent intermediate stops
- if the vehicle is primarily used to travel short distances

- use in mountainous terrain or on poor road surfaces
- if the engine is often left idling for long periods

Under these or similar conditions, have, for example, the air filter, engine oil and oil filter replaced or changed more frequently. Under arduous operating conditions, the tires must be checked more often. Further information can be obtained at a qualified specialist workshop, e.g. an authorized Mercedes-Benz Center.

Driving abroad

An extensive Mercedes-Benz Service network is also available in other countries. You can obtain further information from any authorized Mercedes-Benz Center.

Care

General notes

Environmental note

Dispose of empty packaging and cleaning cloths in an environmentally responsible manner.

- ❗ For cleaning your vehicle, do not use any of the following:

- dry, rough or hard cloths
- abrasive cleaning agents
- solvents
- cleaning agents containing solvents

Do not scrub.

Do not touch the surfaces or protective films with hard objects, e.g. a ring or ice scraper. You could otherwise scratch or damage the surfaces and protective film.

- ❗ Do not park the vehicle for an extended period straight after cleaning it, particularly after having cleaned the wheels with wheel cleaner. Wheel cleaners could cause increased corrosion of the brake discs and brake pads/linings. For this reason, you

should drive for a few minutes after cleaning. Braking heats the brake discs and the brake pads/linings, thus drying them. The vehicle can then be parked.

Regular care of your vehicle is a condition for retaining the quality in the long term.

Use care products and cleaning agents recommended and approved by Mercedes-Benz.

Exterior care

Automatic car wash

WARNING

Braking efficiency is reduced after washing the vehicle. There is a risk of an accident.

After the vehicle has been washed, brake carefully while paying attention to the traffic conditions until full braking power is restored.

! If DISTRONIC PLUS or the HOLD function is activated, the vehicle brakes automatically in certain situations. To prevent damage to the vehicle, deactivate DISTRONIC PLUS and the HOLD function in the following or other similar situations:

- when towing the vehicle
- in the car wash

! Never clean your vehicle in a Touchless Automatic Car Wash as these use special cleaning agents. These cleaning agents can damage the paintwork or plastic parts.

! Make sure that the automatic transmission is in position **N** when washing your vehicle in a tow-through car wash. The vehicle could be damaged if the transmission is in another position.

! Make sure that:

- the side windows and the sliding sunroof are fully closed.
- the ventilation/heating is switched off (the OFF button has been pressed/the airflow control is set to position **0**).
- the windshield wiper switch is in position **0**.

Otherwise, the vehicle might be damaged.

You can wash the vehicle in an automatic car wash from the very start.

If the vehicle is very dirty, pre-wash it before cleaning it in an automatic car wash.

After using an automatic car wash, wipe off wax from the windshield and the wiper blades. This will prevent smears and reduce wiping noises caused by residue on the windshield.

Washing by hand

In some countries, washing by hand is only allowed at wash bays that are specially designed for this purpose. Observe the legal requirements in all countries concerned.

- ▶ Do not use hot water and do not wash the vehicle in direct sunlight.
- ▶ Use a soft sponge to clean.
- ▶ Use a mild cleaning agent, such as a car shampoo approved by Mercedes-Benz.
- ▶ Thoroughly hose down the vehicle with a gentle jet of water.
- ▶ Do not point the water jet directly towards the air inlet.
- ▶ Use plenty of water and rinse out the sponge frequently.
- ▶ Rinse the vehicle with clean water and dry thoroughly with a chamois.
- ▶ Do not let the cleaning agent dry on the paintwork.

When using the vehicle in winter, remove all traces of road salt deposits carefully and as soon as possible.

Power washers

WARNING

The water jet from a circular jet nozzle (dirt blasters) can cause invisible exterior damage to the tires or chassis components.

Components damaged in this way may fail unexpectedly. There is a risk of an accident.

Do not use power washers with circular jet nozzles to clean the vehicle. Have damaged tires or chassis components replaced immediately.

- !** Always maintain a distance of at least 11.8 in (30 cm) between the vehicle and the power washer nozzle. Information about the correct distance is available from the equipment manufacturer.

Move the power washer nozzle around when cleaning your vehicle.

Do not aim directly at any of the following:

- tires
- door gaps, roof gaps, joints, etc.
- electrical components
- battery
- connectors
- lights
- seals
- trim
- ventilation slots

Damaged seals or electrical components can lead to leaks or failures.

Cleaning the wheels

- !** Do not use acidic wheel cleaning products to remove brake dust. This could damage wheel bolts and brake components.

- !** Do not park the vehicle for an extended period straight after cleaning it, particularly after having cleaned the wheels with wheel cleaner. Wheel cleaners could cause increased corrosion of the brake discs and brake pads/linings. For this reason, you should drive for a few minutes after

cleaning. Braking heats the brake discs and the brake pads/linings, thus drying them. The vehicle can then be parked.

Cleaning the paintwork

- !** Do not affix:

- stickers
- films
- magnetic plates or similar items

to painted surfaces. You could otherwise damage the paintwork.

- ▶ Remove dirt immediately, where possible, while avoiding rubbing too hard.
- ▶ Soak insect remains with insect remover and rinse off the treated areas afterwards.
- ▶ Soak bird droppings with water and rinse off the treated areas afterwards.
- ▶ Remove coolant, brake fluid, tree resin, oils, fuels and greases by rubbing gently with a cloth soaked in petroleum ether or lighter fluid.
- ▶ Use tar remover to remove tar stains.
- ▶ Use silicone remover to remove wax.
- ▶ Use a suitable touch-up stick, e.g. MB Touch-Up Stick, to repair slight damage to the paintwork quickly and provisionally.

The following cannot always be completely repaired:

- scratches
- corrosive deposits
- areas affected by corrosion
- damage caused by inadequate care

In such cases, visit a qualified specialist workshop.

If water no longer forms "beads" on the paint surface, use the paint care products recommended and approved by Mercedes-Benz. This is the case approximately every three to five months, depending on the climate conditions and the care product used.

If the dirt has penetrated the paint surface or if the paintwork has become dull, then the paintwork should be cleaned. For cleaning,

please use the paint cleaner recommend and approved by Mercedes Benz.

Do not use these care products in the sun or on the hood while the hood is hot.

Matte finish care

! Never polish the vehicle or the light alloy wheels. Polishing causes the finish to shine.

! The following may cause the paint to become shiny and thus reduce the matte effect:

- Vigorous rubbing with unsuitable materials.
- Frequent use of car washes.
- Washing the vehicle in direct sunlight.

! Never use paint cleaner, buffing or polishing products, or gloss preserver, e.g. wax. These products are only suitable for high-gloss surfaces. Their use on vehicles with matte finish leads to considerable surface damage (shiny, spotted areas).

Always have paintwork repairs carried out at a qualified specialist workshop.

! Do not use wash programs with a hot wax treatment under any circumstances.

Observe these notes if your vehicle has a clear matte finish. This will help you to avoid damage to the paintwork due to incorrect treatment.

These notes also apply to light alloy wheels with a clear matte finish.

- i** The vehicle should preferably be washed by hand using a soft sponge, car shampoo and plenty of water.
- i** Use only insect remover and car shampoo from the range of recommended and approved Mercedes-Benz care products.

Cleaning the windows

WARNING

You could become trapped by the windshield wipers if they start moving while cleaning the windshield or wiper blades. There is a risk of injury.

Always switch off the windshield wipers and the ignition before cleaning the windshield or wiper blades.

! Only fold the windshield wipers away from the windshield when vertical. Otherwise, you will damage the hood.

! Do not use dry cloths, abrasive products, solvents or cleaning agents containing solvents to clean the inside of the windows. Do not touch the insides of the windows with hard objects, e.g. an ice scraper or ring. There is otherwise a risk of damaging the windows.

! Clean the water drainage channels of the windshield and the rear window at regular intervals. Deposits such as leaves, petals and pollen may under certain circumstances prevent water from draining away. This can lead to corrosion damage and damage to electronic components.

► Clean the inside and outside of the windows with a damp cloth and a cleaning product that is recommended and approved by Mercedes-Benz.

Cleaning wiper blades

WARNING

You could become trapped by the windshield wipers if they start moving while cleaning the windshield or wiper blades. There is a risk of injury.

Always switch off the windshield wipers and the ignition before cleaning the windshield or wiper blades.

- ❗ Only fold the windshield wipers away from the windshield when vertical. Otherwise, you will damage the hood.
 - ❗ Do not pull the wiper blade. Otherwise, the wiper blade could be damaged.
 - ❗ Do not clean wiper blades too often and do not rub them too hard. Otherwise, the graphite coating could be damaged. This could cause wiper noise.
- ▶ Fold the windshield wiper arms away from the windshield.
 - ▶ Carefully clean the wiper blades with a damp cloth.
 - ▶ Fold the windshield wiper arms back again before switching on the ignition.
- ❗ Hold the wiper arm securely when folding back. The windshield could be damaged if the wiper arm smacks against it suddenly.

Cleaning the exterior lighting

- ❗ Only use cleaning agents or cleaning cloths which are suitable for plastic light lenses. Unsuitable cleaning agents or cleaning cloths could scratch or damage the plastic light lenses.
- ▶ Clean the plastic lenses of the exterior lighting using a wet sponge and a mild cleaning agent, e.g. Mercedes-Benz car shampoo or cleaning cloths.

Cleaning the mirror turn signals

- ❗ Only use cleaning agents or cleaning cloths that are suitable for plastic lenses. Unsuitable cleaning agents or cleaning cloths could scratch or damage the plastic lenses of the mirror turn signals.
- ▶ Clean the plastic lenses of the mirror turn signals in the exterior mirror housing using a wet sponge and a mild cleaning agent, e.g. Mercedes-Benz car shampoo or cleaning cloths.

Cleaning the sensors

- ❗ If you clean the sensors with a power washer, make sure that you keep a distance of at least 11.8 in (30 cm) between the vehicle and the power washer nozzle. Information about the correct distance is available from the equipment manufacturer.

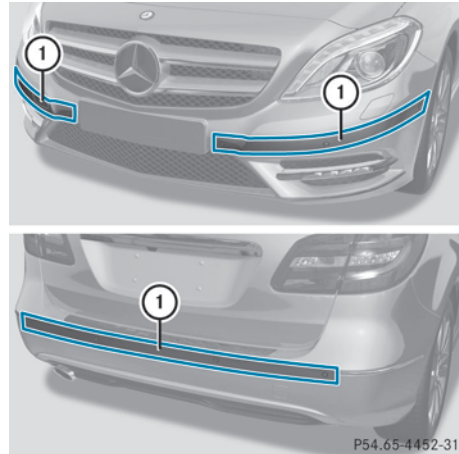

- ▶ Clean sensors ① of the driving systems with water, car shampoo and a soft cloth.

Cleaning the rear view camera

- ❗ Do not clean the camera lens and the area around the rear view camera with a power washer.

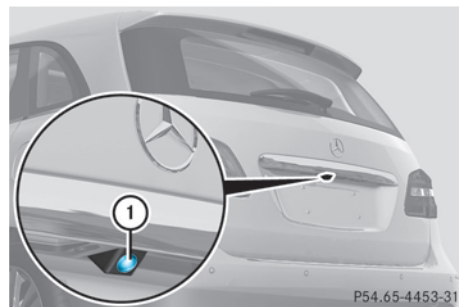

- ▶ Use clear water and a soft cloth to clean camera lens ①.

Cleaning the exhaust pipe

Impurities combined with the effects of road grit and corrosive environmental factors may cause flash rust to form on the surface. You can restore the original shine of the exhaust pipe by cleaning it regularly, especially in winter and after washing.

! Do not clean the exhaust pipe with acid-based cleaning agents such as sanitary cleansers or wheel cleaners.

- ▶ Clean the exhaust pipe with a care product tested and approved by Mercedes-Benz.

Interior care

Cleaning the display

! For cleaning, do not use any of the following:

- alcohol-based thinner or gasoline
- abrasive cleaning agents
- commercially-available household cleaning agents

These may damage the display surface. Do not put pressure on the display surface when cleaning. This could lead to irreparable damage to the display.

- ▶ Before cleaning the display, make sure that it is switched off and has cooled down.
- ▶ Clean the display surface using a commercially available microfiber cloth and TFT/LCD display cleaner.
- ▶ Dry the display surface using a dry microfiber cloth.

Cleaning the plastic trim

WARNING

Care products and cleaning agents containing solvents cause surfaces in the cockpit to become porous. As a result, plastic parts may come loose in the event of air bag deployment. There is a risk of injury.

Do not use any care products and cleaning agents to clean the cockpit.

! Do not affix the following to plastic surfaces:

- stickers
- films
- scented oil bottles or similar items

You can otherwise damage the plastic.

! Do not allow cosmetics, insect repellent or sunscreen to come into contact with the plastic trim. This maintains the high-quality look of the surfaces.

- ▶ Wipe the plastic trim with a damp, lint-free cloth, e.g. a microfiber cloth.
- ▶ **Heavy soiling:** use care and cleaning products recommended and approved by Mercedes-Benz. The surface may change color temporarily. Wait until the surface is dry again.

Cleaning the steering wheel and gear or selector lever

- ▶ Thoroughly wipe with a damp cloth or use leather care agents that have been recommended and approved by Mercedes-Benz.

Cleaning genuine wood and trim elements

! Do not use solvent-based cleaning agents such as tar remover, wheel cleaners, polishes or waxes. There is otherwise a risk of damaging the surface.

! Do not use chrome polish on trim pieces. The trim pieces have a chrome look but are mostly made of anodized aluminum and can lose their shine if chrome polish is used. Use a damp, lint-free cloth instead when cleaning the trim pieces.

If the chrome-plated trim pieces are very dirty, you can use a chrome polish. If you are unsure as to whether the trim pieces

are chrome-plated or not, consult an authorized Mercedes-Benz Center.

- ▶ Wipe the wooden trim and trim pieces with a damp, lint-free cloth, e.g. a microfiber cloth.
- ▶ **Heavy soiling:** use car care and cleaning products recommended and approved by Mercedes-Benz.

Cleaning the seat covers

General notes

- ❗ Do not use microfiber cloths to clean genuine leather, artificial leather or DINAMICA covers. If used often, these can damage the cover.
- i Note that regular care is essential to ensure that the appearance and comfort of the covers is retained over time.

Genuine leather seat covers

Leather is a natural product.

It exhibits natural surface characteristics, for example:

- differences in the texture
- signs of stretching and marking
- slight nuances of color

These are characteristics of leather and not material defects.

- ❗ To retain the natural appearance of the leather, observe the following cleaning instructions:
 - Clean genuine leather covers carefully with a damp cloth and then wipe the covers down with a dry cloth.
 - Make sure that the leather does not become soaked. It may otherwise become rough and cracked.
 - Only use leather care agents that have been tested and approved by Mercedes-Benz. You can obtain these from a qualified specialist workshop.

Seat covers of other materials

- ❗ Observe the following when cleaning:
 - Clean artificial leather covers with a cloth moistened with a solution containing 1% detergent (e.g. dish washing liquid).
 - Clean cloth covers with a microfiber cloth moistened with a solution containing 1% detergent (e.g. dish washing liquid). Rub carefully and always wipe entire seat sections to avoid leaving visible lines. Leave the seat to dry afterwards. Cleaning results depend on the type of dirt and how long it has been there.
 - Clean Alcantara® covers with a damp cloth. Make sure that you wipe entire seat sections to avoid leaving visible lines.

Cleaning the seat belts

WARNING

Seat belts can become severely weakened if bleached or dyed. This could cause the seat belts to tear or fail, for instance, in the event of an accident. This poses an increased risk of injury or fatal injury.

Never bleach or dye the seat belts.

- ❗ Do not clean the seat belts using chemical cleaning agents. Do not dry the seat belts by heating at temperatures above 176 °F (80 °C) or in direct sunlight.
- ▶ Use clean, lukewarm water and soap solution.

Cleaning the headliner and carpets

- ▶ **Headliner:** if it is very dirty, use a soft brush or a cleaning agent recommended and approved by Mercedes-Benz.
- ▶ **Carpets:** use the carpet and textile cleaning agents recommended and approved by Mercedes-Benz.

Useful information	294
Where will I find...?	294
Flat tire	295
Battery (vehicle)	299
Jump-starting	303
Towing and tow-starting	305
Fuses	308

Useful information

- i** This Operator's Manual describes all models and all standard and optional equipment of your vehicle available at the time of publication of the Operator's Manual. Country-specific differences are possible. Please note that your vehicle may not be equipped with all features described. This also applies to safety-related systems and functions.
- i** Read the information on qualified specialist workshops: (> page 25).

Where will I find...?

First-aid kit

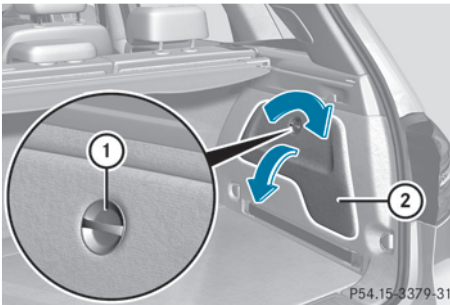

- ▶ Open the tailgate.
- ▶ **To open the stowage compartment:** turn rotary knob ① clockwise and fold down cover ②.

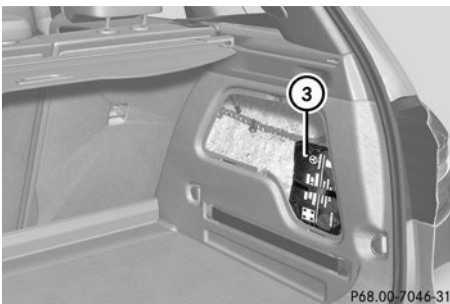

- ▶ Remove first-aid kit ③.

- i** Check the expiration date on first-aid kit ③ at least once a year. Replace the contents if necessary, and replace missing items.

Vehicle tool kit

General notes

Vehicles with the TIREFIT kit: the TIREFIT kit is in the stowage well beneath the cargo compartment floor.

Vehicles with a tire-change tool kit: the tire-change tool kit is in the stowage well beneath the cargo compartment floor.

- i** Apart from certain country-specific variations, the vehicles are not equipped with a tire-change tool kit. Some tools for changing a wheel are specific to the vehicle. For more information on which tools are required and approved to perform a wheel change on your vehicle, consult a qualified specialist workshop. Tools required for changing a wheel may include, for example:

- Jack
- Wheel chock
- Lug wrench

Vehicles with a TIREFIT kit

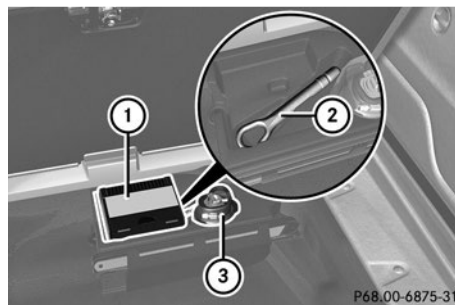

- ① Tire inflation compressor
- ② Towing eye
- ③ Tire sealant filler bottle

- ▶ Open the tailgate.
- ▶ Lift the cargo compartment floor up (▷ page 259).
- ▶ **i** Towing eye ② is located under tire inflation compressor ①.

Vehicles with a tire-change tool kit

- ▶ Open the tailgate.
- ▶ Lift the cargo compartment floor up (▷ page 259).
- ▶ Remove the tire-change tool kit.

The tire-change tool kit contains:

- Jack
- Lug wrench
- One pair of gloves
- Folding wheel chock

Flat tire

Preparing the vehicle

Your vehicle may be equipped with:

- MOExtended tires (tires with run-flat properties) (▷ page 295)
Vehicle preparation is not necessary on vehicles with MOExtended tires.
- a TIREFIT kit (▷ page 294)

Information on changing/mounting a wheel (▷ page 337).

- ▶ Stop the vehicle on solid, non-slippery and level ground, as far away as possible from traffic.
- ▶ Switch on the hazard warning lamps.
- ▶ Secure the vehicle against rolling away (▷ page 152).
- ▶ If possible, bring the front wheels into the straight-ahead position.
- ▶ Switch off the engine.
- ▶ Remove the SmartKey from the ignition lock.

- ▶ All occupants must get out of the vehicle. Make sure that they are not endangered as they do so.
- ▶ Make sure that no one is near the danger area while a wheel is being changed. Anyone who is not directly assisting in the wheel change should, for example, stand behind the barrier.
- ▶ Get out of the vehicle. Pay attention to traffic conditions when doing so.
- ▶ Close the driver's door.

- ▶ **i** Vehicles equipped with MOExtended tires are not equipped with a TIREFIT kit at the factory. It is therefore recommended that you additionally equip your vehicle with a TIREFIT kit if you mount tires that do not feature run-flat properties, e.g. winter tires. A TIREFIT kit can be obtained from a qualified specialist workshop.

MOExtended tires (tires with run-flat properties)

General notes

With MOExtended tires (tires with run flat characteristics), you can continue to drive your vehicle even if there is a total loss of pressure in one or more tires. The affected tire must not show any clearly visible damage. You can recognize MOExtended tires by the MOExtended marking which appears on the sidewall of the tire. You will find this marking next to the tire size designation, the load-bearing capacity and the speed index (▷ page 330).

MOExtended tires may only be used in conjunction with an active tire pressure loss warning system.

If the pressure loss warning message appears in the multifunction display:

- Observe the instructions in the display messages (▷ page 231).
- Check the tire for damage.
- If driving on, observe the following notes.

The maximum driving distance is approximately 50 miles (80 km) when the vehicle is partially laden and approximately 18 miles (30 km) when the vehicle is fully laden.

In addition to the vehicle load, the driving distance possible depends upon:

- Speed
- Road condition
- Outside temperature

The driving distance possible in run-flat mode may be reduced by extreme driving conditions/maneuvers, or it can be increased through a moderate style of driving.

The maximum permissible distance which can be driven in run-flat mode is counted from the moment the tire pressure loss warning appears in the multifunction display.

You must not exceed a maximum speed of 50 mph (80 km/h).

i When replacing one or all tires, make sure that you use only tires:

- of the size specified for the vehicle and
- marked "MOExtended"

If a tire has gone flat and cannot be replaced with a MOExtended tire, a standard tire may be used as a temporary measure. Make sure that you use the proper size and type (summer or winter tire).

i Vehicles equipped with MOExtended tires are not equipped with a TIREFIT kit at the factory. It is therefore recommended that you additionally equip your vehicle with a TIREFIT kit if you mount tires that do not feature run-flat properties, e.g. winter tires. A TIREFIT kit can be obtained from a qualified specialist workshop.

Important safety notes

WARNING

When driving in emergency mode, the driving characteristics deteriorate, e.g. when

cornering, accelerating quickly and when braking. There is a risk of an accident.

Do not exceed the stated maximum speed. Avoid abrupt steering and driving maneuvers, and driving over obstacles (curbs, potholes, off-road). This applies in particular to a laden vehicle.

Stop driving in emergency mode if:

- you hear banging noises.
- the vehicle starts to shake.
- you see smoke and smell rubber.
- ESP® is intervening constantly.
- there are tears in the sidewalls of the tire.

After driving in emergency mode, have the wheel rims checked at a qualified specialist workshop with regard to their further use. The defective tire must be replaced in every case.

TIREFIT kit

Important safety notes

TIREFIT is a tire sealant.

You can use TIREFIT to seal punctures of up to 0.16 in (4 mm), particularly those in the tire tread. You can use TIREFIT at outside temperatures down to -4 °F (-20 °C).

WARNING

In the following situations, the tire sealant is unable to provide sufficient breakdown assistance, as it is unable to seal the tire properly:

- there are cuts or punctures in the tire larger than those mentioned above.
- the wheel rim is damaged.
- you have driven at very low tire pressures or on a flat tire.

There is a risk of an accident.

Do not drive the vehicle. Contact a qualified specialist workshop.

⚠ WARNING

The tire sealant is harmful and causes irritation. It must not come into contact with your skin, eyes or clothing or be swallowed. Do not inhale TIREFIT fumes. Keep tire sealant away from children. There is a risk of injury. If you come into contact with the tire sealant, observe the following:

- Rinse off the tire sealant from your skin immediately with water.
- If the tire sealant comes into contact with your eyes, immediately rinse them thoroughly with clean water.
- If tire sealant is swallowed, immediately rinse your mouth out thoroughly and drink plenty of water. Do not induce vomiting, and seek medical attention immediately.
- Immediately change out of clothing which has come into contact with tire sealant.
- If an allergic reaction occurs, seek medical attention immediately.

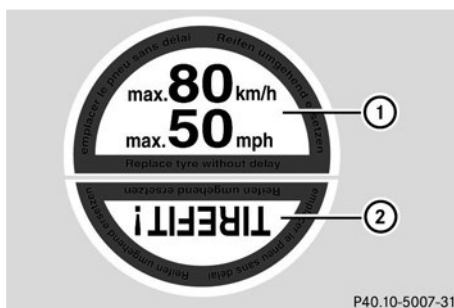
Using the TIREFIT kit

TIREFIT sticker, 2-part

- ▶ Do not remove any foreign objects which have penetrated the tire, e.g. screws or nails.
- ▶ Remove the tire sealant bottle, the accompanying TIREFIT sticker and the tire inflation compressor from the stowage well underneath the cargo compartment floor (▷ page 294).

- ▶ Affix part ① of the TIREFIT sticker within the driver's field of vision.
- ▶ Affix part ② of the TIREFIT sticker near the valve on the wheel with the defective tire.

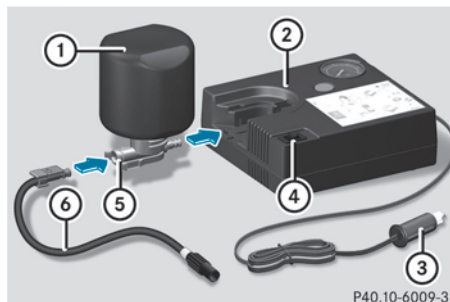

- ▶ Remove filler hose ⑥ and plug ③ from the bottom section of the tire inflation compressor housing.
- ▶ Slide the yellow filler hose connector into the mounting on yellow cap ⑤ of tire sealant bottle ① until the plug engages.
- ▶ With the sealing rings in front, slide yellow cap ⑤ of tire sealant bottle ① into the mounting of tire inflation compressor ② until the cap and both hooks engage.

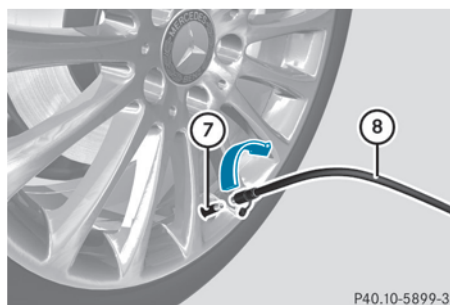

- ▶ Remove the cap from valve ⑦ on the faulty tire.
- ▶ Screw filler hose ⑧ onto valve.
- ▶ Insert plug ③ into the socket of the cigarette lighter (▷ page 264) or into a 12 V power socket in your vehicle (▷ page 264).
- ▶ Turn the SmartKey to position 1 in the ignition lock (▷ page 137).

- ▶ Press on/off switch ④ on the tire inflation compressor to **ON**.

The tire inflation compressor is switched on. The tire is inflated.

- ❗ First, tire sealant is pumped into the tire. The pressure can briefly rise to approximately 500 kPa (5 bar/73 psi).

Do not switch off the tire inflation compressor during this phase.

- ▶ Let the tire inflation compressor run for a maximum of ten minutes. The tire should then have attained a pressure of at least 200 kPa (2.0 bar/29 psi).

- ❗ Do not operate the tire inflation compressor for longer than ten minutes at a time without a break. It may otherwise overheat.

The tire inflation compressor can be operated again once it has cooled down.

If a tire pressure of 200 kPa (2.0 bar/29 psi) is achieved after a maximum of ten minutes, see (▷ page 298).

If a tire pressure of 200 kPa (2.0 bar/29 psi) is not achieved after a maximum of ten minutes, see (▷ page 298).

- ❗ If tire sealant leaks out, allow it to dry. It can then be removed like a layer of film.

If your clothes are soiled with tire sealant, have them cleaned with perchloroethylene at a dry cleaner as soon as possible.

Tire pressure not reached

If a pressure of 200 kPa (2.0 bar/29 psi) has not been achieved after ten minutes:

- ▶ Switch off the tire inflation compressor.
- ▶ Unscrew the filler hose from the valve of the faulty tire.
- ▶ Very slowly drive forwards or reverse approximately 30 ft (10 m).
- ▶ Pump up the tire again.

After a maximum of ten minutes, the tire pressure must be at least 200 kPa (2.0 bar/29 psi).

⚠ WARNING

If the required tire pressure is not reached after the specified time, the tire is too badly damaged. The tire sealant cannot repair the tire in this instance. Damaged tires and a tire pressure that is too low can significantly impair the vehicle's braking and driving characteristics. There is a risk of accident.

Do not continue driving. Contact a qualified specialist workshop.

Tire pressure reached

⚠ WARNING

A tire temporarily sealed with tire sealant impairs the driving characteristics and is not suitable for higher speeds. There is a risk of accident.

You should therefore adapt your driving style accordingly and drive carefully. Do not exceed the specified maximum speed with a tire that has been repaired using tire sealant.

- ❗ After use, excess tire sealant may run out of the filler hose. This could cause stains.

Therefore, place the filler hose in the plastic bag that contained the TIREFIT kit.

♻ Environmental note

Have the used tire sealant bottle disposed of professionally, e.g. at a qualified specialist workshop.

If a tire pressure of 200 kPa (2.0 bar/29 psi) has been achieved after ten minutes:

- ▶ Switch off the tire inflation compressor.
- ▶ Unscrew the filler hose from the valve of the faulty tire.
- ▶ Stow the tire sealant bottle and the tire inflation compressor.
- ▶ **Pull away immediately.**

The maximum speed for a tire sealed with tire sealant is 50 mph (80 km/h). The upper part of the TIREFIT sticker must be affixed to the instrument cluster in the driver's field of vision.

- ▶ Stop after driving for approximately ten minutes and check the tire pressure with the tire inflation compressor. The tire pressure must now be at least 130 kPa (1.3 bar/19 psi).

WARNING

If the required tire pressure is not reached after driving for a short period, the tire is too badly damaged. The tire sealant cannot repair the tire in this instance. Damaged tires and a tire pressure that is too low can significantly impair the vehicle's braking and driving characteristics. There is a risk of accident. Do not continue driving. Contact a qualified specialist workshop.

- ▶ Correct the tire pressure if it is still at least 130 kPa (1.3 bar/19 psi) (for the values, see the Tire and Loading Information placard on the driver's side B-pillar or tire pressure table on the fuel filler flap).
- ▶ **To increase the tire pressure:** switch on the tire inflation compressor.

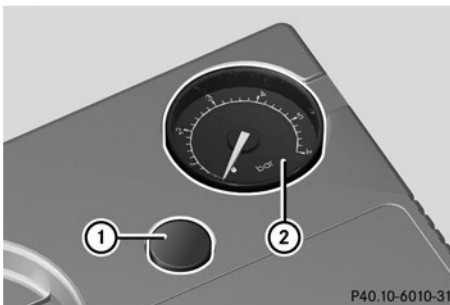

- ▶ **To reduce the tire pressure:** depress pressure release button ① next to pressure gauge ②.

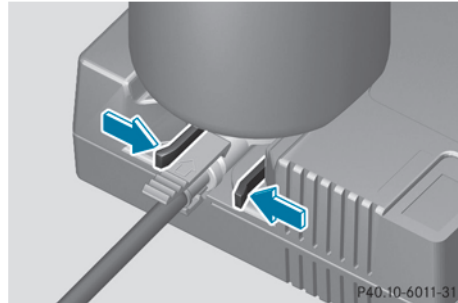

- ▶ To remove the tire sealant bottle from the tire inflation compressor, press together the locking tabs on the yellow cap.
- ▶ Pull the tire sealant bottle out of the tire inflation compressor. The filler hose remains attached to the tire sealant bottle.
- ▶ Stow the tire sealant bottle and the tire inflation compressor.
- ▶ Drive to the nearest qualified specialist workshop and have the tire changed there.
- ▶ Have the tire sealant bottle and the filler hose replaced as soon as possible at a qualified specialist workshop.
- ▶ Have the tire sealant bottle replaced every four years at a qualified specialist workshop.

Battery (vehicle)

Important safety notes

Special tools and expert knowledge are required when working on the battery, e.g. removal and installing. You should therefore have all work involving the battery carried out at a qualified specialist workshop.

⚠ WARNING

Work carried out incorrectly on the battery can lead, for example, to a short circuit and thus damage the vehicle electronics. This can lead to function restrictions applying to safety-relevant systems, e.g. the lighting system, ABS (anti-lock braking system) or ESP® (Electronic Stability Program). The operating safety of your vehicle may be restricted. You could lose control of the vehicle, for example:

- braking
- in the event of abrupt steering maneuver and/or when the vehicle's speed is not adapted to the road conditions

There is a risk of an accident.

In the event of a short circuit or a similar incident, contact a qualified specialist workshop immediately. Do not drive any further. You should have all work involving the battery carried out at a qualified specialist workshop.

For further information about ABS and ESP®, see (▷ page 63) and (▷ page 67).

⚠ WARNING

Electrostatic build-up can lead to the creation of sparks, which could ignite the highly explosive gases of a battery. There is a risk of an explosion.

Before handling the battery, touch the vehicle body to remove any existing electrostatic build-up.

The highly flammable gas mixture forms when charging the battery as well as when jump-starting.

Always make sure that neither you nor the battery is electrostatically charged. A build-up of electrostatic charge can be caused, for example:

- by wearing clothing made from synthetic fibers
- due to friction between clothing and seats

- if you push or pull the battery across the carpet or other synthetic materials
- if you wipe the battery with a cloth

⚠ WARNING

During the charging process, a battery produces hydrogen gas. If a short circuit occurs or sparks are created, the hydrogen gas can ignite. There is a risk of an explosion.

- Make sure that the positive terminal of a connected battery does not come into contact with vehicle parts.
- Never place metal objects or tools on a battery.
- It is important that you observe the described order of the battery terminals when connecting and disconnecting a battery.
- When jump-starting, make sure that the battery poles with identical polarity are connected.
- It is particularly important to observe the described order when connecting and disconnecting the jumper cables.
- Never connect or disconnect the battery terminals while the engine is running.

⚠ WARNING

Battery acid is caustic. There is a risk of injury. Avoid contact with the skin, eyes or clothing. Do not inhale any battery gases. Do not lean over the battery. Keep children away from batteries. Wash battery acid immediately with water and seek medical attention.

♻ Environmental note

Batteries contain dangerous substances. It is against the law to dispose of them with the household rubbish. They must be collected separately and recycled to protect the environment.



Dispose of batteries in an environmentally friendly manner. Take discharged

batteries to a qualified specialist workshop or a special collection point for used batteries.

- ❗ Have the battery checked regularly at a qualified specialist workshop.

Observe the service intervals in the Maintenance Booklet or contact a qualified specialist workshop for more information.

- ❗ You should have all work involving the battery carried out at a qualified specialist workshop. In the exceptional case that it is necessary for you to disconnect the battery yourself, make sure that:

- you switch off the engine and remove the SmartKey. Check that all the indicator lamps in the instrument cluster are off. Otherwise, electronic components, such as the alternator, may be damaged.
- you first remove the negative terminal clamp and then the positive terminal clamp. Never swap the terminal clamps. Otherwise, the vehicle's electronic system may be damaged.
- on vehicles with automatic transmission, the transmission is locked in position **P** after disconnecting the battery. The vehicle is secured against rolling away. You can then no longer move the vehicle.

The battery and the cover of the positive terminal clamp must be installed securely during operation.

Comply with safety precautions and take protective measures when handling batteries.



Risk of explosion.



Fire, open flames and smoking are prohibited when handling the battery. Avoid creating sparks.



Battery acid is caustic. Avoid contact with skin, eyes or clothing.

Wear suitable protective clothing, especially gloves, apron and faceguard.

Rinse any acid spills immediately with clear water. Contact a physician if necessary.

Wear eye protection.



Keep children away.



Observe this Operator's Manual.

For safety reasons, Mercedes-Benz recommends that you only use batteries that have been tested and approved for your vehicle by Mercedes-Benz. These batteries have greater impact resistance and as a result there is no risk of acid burns to occupants when a battery is damaged in an accident.

In order for the battery to achieve the maximum possible service life, it must always be sufficiently charged.

Like other batteries, the vehicle battery may discharge over time if you do not use the vehicle. In this case, have the battery disconnected at a qualified specialist workshop. You can also charge the battery with a charger recommended by Mercedes-Benz. Contact a qualified specialist workshop for further information.

Have the battery condition of charge checked more frequently if you use the vehicle mainly for short trips or if you leave it standing idle for a lengthy period. Consult a qualified specialist workshop if you wish to leave your vehicle parked for a long period of time.

Only replace a battery with a battery that has been recommended by Mercedes-Benz.

- i** Remove the SmartKey if you park the vehicle and do not require any electrical consumers. The vehicle will then use very little energy, thus conserving battery power.
- i** If the power supply has been interrupted, e.g. if you reconnect the battery, you will have to:
 - set the clock (audio system/COMAND, see the separate operating instructions).
 - reset the function for folding the exterior mirrors in/out automatically, by folding the mirrors out once (▷ page 100).

Charging the battery

WARNING

During charging and jump-starting, explosive gases can escape from the battery. There is a risk of an explosion.

Particularly avoid fire, open flames, creating sparks and smoking. Ensure there is sufficient ventilation while charging and jump-starting. Do not lean over a battery.

WARNING

Battery acid is caustic. There is a risk of injury. Avoid contact with the skin, eyes or clothing. Do not inhale any battery gases. Do not lean over the battery. Keep children away from batteries. Wash battery acid immediately with water and seek medical attention.

WARNING

A discharged battery can freeze at temperatures below freezing point. When jump-starting the vehicle or charging the battery, gases can escape from the battery. There is a risk of an explosion. Allow the frozen battery to thaw out before charging it or jump-starting.

- !** Only use battery chargers with a maximum charging voltage of 14.8 V.

- !** Only charge the battery using the jump-starting connection point.

The jump-starting connection point is in the engine compartment (▷ page 303).

- ▶ Open the hood.
- ▶ Connect the battery charger to the positive terminal and ground point in the same order as when connecting the donor battery in the jump-starting procedure (▷ page 303).

If, at low temperatures, the indicator lamps/warning lamps in the instrument cluster do not light up, it is highly likely that the discharged battery has frozen. In this case you may neither jump-start the vehicle nor charge the battery. The service life of a thawed-out battery may be shorter. The starting characteristics can be impaired, particularly at low temperatures. Have the thawed-out battery checked at a qualified specialist workshop.

Only charge the installed battery with a battery charger which has been tested and approved by Mercedes-Benz. An accessory battery charge unit specially adapted for Mercedes-Benz vehicles and tested and approved by Mercedes-Benz is available. It permits the charging of the battery in its installed position. Contact an authorized Mercedes-Benz Center for further information and availability. Read the battery charger's operating instructions before charging the battery.

Jump-starting

For the jump-starting procedure, use only the jump-starting connection point, consisting of a positive terminal and an earth point, in the engine compartment.

WARNING

Battery acid is caustic. There is a risk of injury.

Avoid contact with the skin, eyes or clothing. Do not inhale any battery gases. Do not lean over the battery. Keep children away from batteries. Wash battery acid immediately with water and seek medical attention.

WARNING

During charging and jump-starting, explosive gases can escape from the battery. There is a risk of an explosion.

Particularly avoid fire, open flames, creating sparks and smoking. Ensure there is sufficient ventilation while charging and jump-starting. Do not lean over a battery.

WARNING

During the charging process, a battery produces hydrogen gas. If a short circuit occurs or sparks are created, the hydrogen gas can ignite. There is a risk of an explosion.

- Make sure that the positive terminal of a connected battery does not come into contact with vehicle parts.
- Never place metal objects or tools on a battery.
- It is important that you observe the described order of the battery terminals when connecting and disconnecting a battery.
- When jump-starting, make sure that the battery poles with identical polarity are connected.
- It is particularly important to observe the described order when connecting and disconnecting the jumper cables.
- Never connect or disconnect the battery terminals while the engine is running.

WARNING

A discharged battery can freeze at temperatures below freezing point. When jump-starting the vehicle or charging the battery, gases can escape from the battery. There is a risk of an explosion.

Allow the frozen battery to thaw out before charging it or jump-starting.

! Avoid repeated and lengthy starting attempts. Otherwise, the catalytic converter could be damaged by the non-combusted fuel.

If, at low temperatures, the indicator lamps/warning lamps in the instrument cluster do not light up, it is highly likely that the discharged battery has frozen. In this case you may neither jump-start the vehicle nor charge the battery. The service life of a thawed-out battery may be shorter. The starting characteristics can be impaired, particularly at low temperatures. Have the thawed-out battery checked at a qualified specialist workshop.

Do not start the vehicle using a rapid charging device. If your vehicle's battery is discharged, the engine can be jump-started from another vehicle or from a second battery using jumper cables. Observe the following points:

- The battery is not accessible in all vehicles. If the other vehicle's battery is not accessible, jump-start the vehicle using a second battery or a jump-starting device.
- You may only jump-start the vehicle when the engine and exhaust system are cold.
- Do not start the engine if the battery is frozen. Let the battery thaw first.
- Only jump-start from batteries with a 12 V voltage rating.
- Only use jumper cables which have a sufficient cross-section and insulated terminal clamps.
- If the battery is fully discharged, leave the battery that is being used to jump-start connected for a few minutes before attempting to start. This charges the battery slightly.
- Make sure that the two vehicles do not touch.

Make sure that:

- the jumper cables are not damaged.
- bare parts of the terminal clamp do not come into contact with other metal parts while the jumper cables are connected to the battery.
- the jumper cables cannot come into contact with parts which can move when the engine is running, such as the V-belt pulley or the fan.
- ▶ Secure the vehicle by applying the electric parking brake.
- ▶ Shift the transmission to position **P**.
- ▶ Turn the SmartKey to position **0** in the ignition lock and remove it.
- ▶ Switch off all electrical consumers, e.g. rear window defroster, lighting, etc.
- ▶ Open the hood.

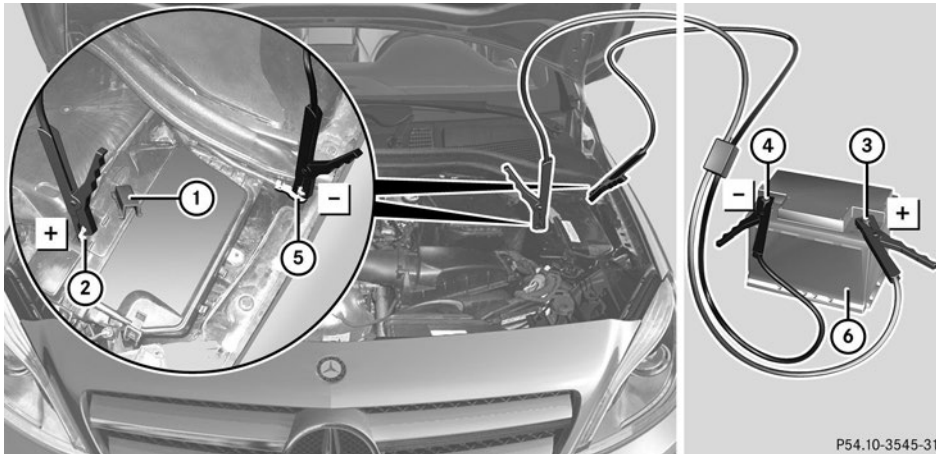

Position number ⑥ identifies the charged battery of the other vehicle or an equivalent jump-starting device.

- ▶ Press together cover ① of positive clamp ② and slide it back.
- ▶ Connect positive terminal ② on your vehicle to positive terminal ③ of donor battery ⑥ using the jumper cable, beginning with your own battery.
- ▶ Start the engine of the donor vehicle and run it at idling speed.
- ▶ Connect negative terminal ④ of donor battery ⑥ to ground point ⑤ of your vehicle using the jumper cable, connecting the jumper cable to battery of other vehicle ⑥ first.
- ▶ Start the engine.
- ▶ Before disconnecting the jumper cables, let the engine run for several minutes.
- ▶ First, remove the jumper cables from earth point ⑤ and negative terminal ④, then from positive clamp ② and positive terminal ③. Begin each time at the contacts on your own vehicle first.
- ▶ Close cover ① of positive terminal ② after removing the jumper cables.
- ▶ Have the battery checked at a qualified specialist workshop.

i Jump-starting is not considered to be a normal operating condition.

i Jumper cables and further information regarding jump-starting can be obtained at any qualified specialist workshop.

Towing and tow-starting

Important safety notes

WARNING

Functions relevant to safety are restricted or no longer available if:

- the engine is not running.
- the brake system or the power steering is malfunctioning.
- there is a malfunction in the voltage supply or the vehicle's electrical system.

If your vehicle is being towed, much more force may be necessary to steer or brake. There is a risk of an accident.

In such cases, use a tow bar. Before towing, make sure that the steering moves freely.

WARNING

If the weight of the vehicle to be towed or tow-started is greater than the permissible gross weight of your vehicle:

- the towing eye could detach itself
- the vehicle/trailer combination could rollover.

There is a risk of an accident.

When towing or tow-starting another vehicle, its weight should not be greater than the permissible gross weight of your vehicle.

Information on your vehicle's gross vehicle weight rating can be found on the vehicle identification plate (▷ page 346).

! When COLLISION PREVENTION ASSIST PLUS, DISTRONIC PLUS or the HOLD function is activated, the vehicle brakes automatically in certain situations. To avoid damage to the vehicle, deactivate these systems in the following or similar situations:

- when towing the vehicle
- in the car wash

! Only secure the tow rope or tow bar at the towing eyes. Otherwise, the vehicle could be damaged.

! Do not use the towing eyes for recovery purposes as this could damage the vehicle. If in doubt, recover the vehicle with a crane.

! When towing, pull away slowly and smoothly. If the tractive power is too high, the vehicles could be damaged.

! The vehicle can be towed a maximum of 30 miles (50km). The towing speed of 30 mph (50km/h) must not be exceeded. If the vehicle has to be towed more than 30 miles (50km), the front axle must be raised or the entire vehicle raised and transported.

! Do not tow with sling-type equipment. This could damage the vehicle.

! Vehicles with automatic transmission must not be started by tow-starting. This could otherwise damage the transmission.

It is better to have the vehicle transported than to have it towed.

When towing a vehicle, the transmission must be in position **N**.

The battery must be connected and charged. Otherwise, you:

- cannot turn the SmartKey to position **2** in the ignition lock
- cannot shift the transmission to position **N**.

i Disarm the automatic locking feature before the vehicle is towed (▷ page 205).

You could otherwise be locked out when pushing or towing the vehicle.

Installing/removing the towing eye

Installing the towing eye

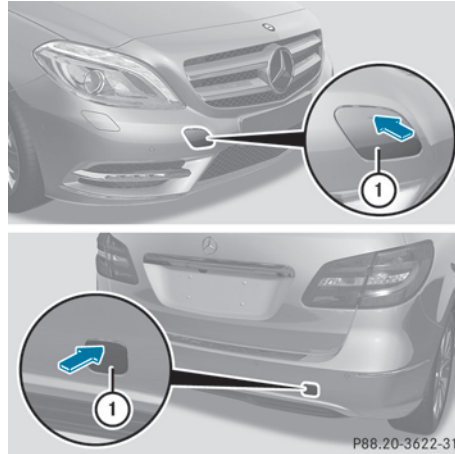

Example: towing eye mounting covers

- ▶ Remove the towing eye from the stowage space.
The towing eye is beneath the cargo compartment floor with the vehicle tool kit (▷ page 294).
Vehicles with the TIREFIT kit: the towing eye is beneath the tire inflation compressor.
- ▶ Press the mark on cover ① inwards in the direction of the arrow.
- ▶ Take cover ① off the opening.
- ▶ Screw in and tighten the towing eye clockwise to the stop.

Removing the towing eye

- ▶ Unscrew and remove the towing eye.
- ▶ Attach cover ① to the bumper and press until it engages.

- ▶ Place the towing eye in the stowage well beneath the cargo compartment floor (▷ page 294) in the cargo compartment.
- ▶ Vehicles with the TIREFIT kit: put back the tire inflation compressor.

Towing the vehicle with the front axle raised

- ❗ The ignition must be switched off if the vehicle is being towed with the front axle raised. Otherwise, ESP® may intervene and damage the brake system.
- ▶ Turn the SmartKey to position **2** in the ignition lock.
- ▶ When the vehicle is stationary, depress the brake pedal and keep it depressed.
- ▶ Shift the automatic transmission to position **P**.
- ▶ Release the brake pedal.
- ▶ Release the electric parking brake.
- ▶ Switch off the automatic locking (▷ page 205).
- ▶ Switch on the hazard warning lamps (▷ page 107).
- ▶ Turn the SmartKey to position **0** in the ignition lock and leave the SmartKey in the ignition lock.

Observe the important safety notes when towing your vehicle with the front axle raised (▷ page 305).

Towing a vehicle with both axles on the ground

- ❗ In order to signal a change of direction when towing with the hazard warning lamps switched on, use the combination switch as usual. In this case, only the indicator lamps for the direction of travel flash. After resetting the combination switch, the hazard warning lamp starts flashing again.

The automatic transmission automatically shifts to position **P** when you open the driver's or front-passenger door or when you remove the SmartKey from the ignition lock. In order to ensure that the automatic transmission stays in position **N** when towing the vehicle, you must observe the following points:

- ▶ Make sure that the vehicle is stationary.
- ▶ Turn the SmartKey to position **2** in the ignition lock.
- ▶ Depress and hold the brake pedal.
- ▶ Shift the automatic transmission to position **N**.
- ▶ Leave the SmartKey in position **2** in the ignition lock.
- ▶ Release the brake pedal.
- ▶ Release the electric parking brake.
- ▶ Switch on the hazard warning lamps (▷ page 107).

It is important that you observe the safety instructions when towing away your vehicle (▷ page 305).

Transporting the vehicle

- ❗ You may only secure the vehicle by the wheels, not by parts of the vehicle such as axle or steering components. Otherwise, the vehicle could be damaged.
- ▶ Turn the SmartKey to position **2** in the ignition lock.
- ▶ Shift the transmission to position **N**.

As soon as the vehicle has been loaded:

- ▶ Prevent the vehicle from rolling away by applying the electric parking brake.
- ▶ Shift the transmission to position **P**.
- ▶ Turn the SmartKey to position **0** in the ignition lock and remove it.
- ▶ Secure the vehicle.

The towing eye can be used to pull the vehicle onto a trailer or transporter for transporting purposes.

Tow-starting (emergency engine starting)

! Vehicles with automatic transmission must not be tow-started. You could otherwise damage the automatic transmission.

Fuses**Important safety notes****⚠ WARNING**

If you manipulate or bridge a faulty fuse or if you replace it with a fuse with a higher amperage, the electric cables could be overloaded. This could result in a fire. There is a risk of an accident and injury.

Always replace faulty fuses with the specified new fuses having the correct amperage.

! Only use fuses that have been approved for Mercedes-Benz vehicles and which have the correct fuse rating for the system concerned. Only use fuses marked with an "S". Otherwise, components or systems could be damaged.

The fuses in your vehicle serve to close down faulty circuits. If a fuse blows, all the components on the circuit and their functions stop operating.

Blown fuses must be replaced with fuses of the same rating, which you can recognize by the color and value. The fuse ratings are listed in the fuse allocation chart.

If a newly inserted fuse also blows, have the cause traced and rectified at a qualified specialist workshop, e.g. an authorized Mercedes-Benz Center.

Before changing a fuse

- ▶ Secure the vehicle against rolling away (▷ page 152).
- ▶ Switch off all electrical consumers.
- ▶ Turn the SmartKey to position **0** in the ignition lock and remove it (▷ page 137). All indicator lamps in the instrument cluster must be off.

The fuses are located in various fuse boxes:

- Fuse box in the engine compartment on the left-hand side of the vehicle, when viewed in the direction of travel
- Fuse box in the front-passenger footwell

The fuse allocation chart is on the fuse box in the front-passenger footwell (▷ page 309).

Fuse box in the engine compartment**⚠ WARNING**

When the hood is open and the windshield wipers are set in motion, you can be injured by the wiper linkage. There is a risk of injury. Always switch off the windshield wipers and the ignition before opening the hood.

- !** Make sure that no moisture can enter the fuse box when the cover is open.
- !** When closing the cover, make sure that it is lying correctly on the fuse box. Moisture seeping in or dirt could otherwise impair the operation of the fuses.

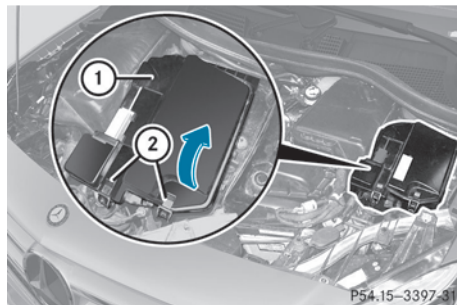

- ▶ Open the hood.
- ▶ Use a dry cloth to remove any moisture from the fuse box.
- ▶ **To open:** open clamps ②.
- ▶ Fold up cover ① in the direction of the arrow and remove it.

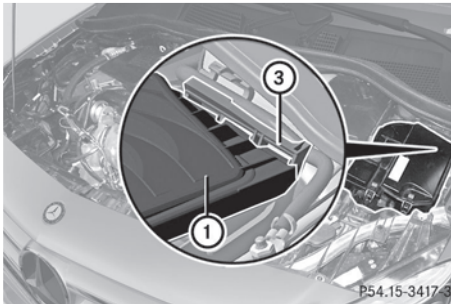

- ▶ **To close:** check whether the seal is seated correctly in cover ①.
- ▶ Insert cover ① at the back into openings ③ on the fuse box.
- ▶ Fold down cover ①.
- ▶ Hook clamps ② into the fuse box and close.
- ▶ Close the hood.

Fuse box in the front-passenger footwell

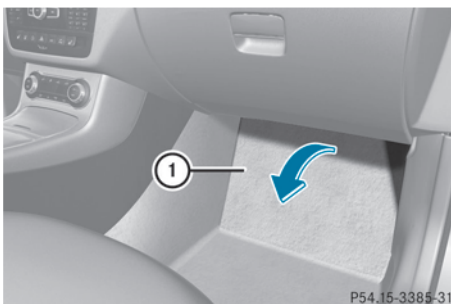

- ▶ **To open:** remove the floormat from the front-passenger side.
- ▶ Fold out perforated floor covering ① in the direction of the arrow.

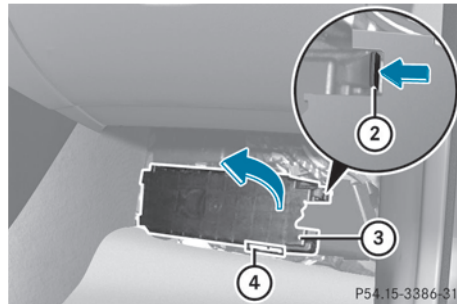

- ▶ To release cover ③, press retaining clamp ②.
- ▶ Fold out cover ③ in the direction of the arrow to the catch.
- ▶ Remove cover ③ forwards.
- ▶ **i** Fuse allocation chart ④ is located on the lower right-hand side of cover ③.
- ▶ **To close:** insert cover ③ on the left-hand side of the fuse box into the retainer. Cover ③ engages in the retainers.
- ▶ Fold down cover ③ until clamps ② lock audibly.
- ▶ Fold back perforated floor covering ①.

Useful information	312
Important safety notes	312
Operation	312
Winter operation	314
Tire pressure	315
Loading the vehicle	323
Maximum load rating	327
Uniform Tire Quality Grading Standards	328
Tire labeling	329
Definition of terms for tires and loading	333
Changing a wheel	336
Wheel and tire combinations	340
Emergency spare wheel	342

Useful information

- i** This Operator's Manual describes all models and all standard and optional equipment of your vehicle available at the time of publication of the Operator's Manual. Country-specific differences are possible. Please note that your vehicle may not be equipped with all features described. This also applies to safety-related systems and functions.
- i** Read the information on qualified specialist workshops: (▷ page 25).

Important safety notes

WARNING

If wheels and tires of the wrong size are used, the wheel brakes or suspension components may be damaged. There is a risk of an accident.

Always replace wheels and tires with those that fulfill the specifications of the original part.

When replacing wheels, make sure to use the correct:

- designation
- model

When replacing tires, make sure to use the correct:

- designation
- manufacturer
- model

WARNING

A flat tire severely impairs the driving, steering and braking characteristics of the vehicle. There is a risk of accident.

Tires without run-flat characteristics:

- do not drive with a flat tire.
- immediately replace the flat tire with your emergency spare wheel or spare wheel, or consult a qualified specialist workshop.

Tires with run-flat characteristics:

- pay attention to the information and warning notices on MOExtended tires (tires with run-flat characteristics).

Accessories that are not approved for your vehicle by Mercedes-Benz or that are not being used correctly can impair operating safety.

Before purchasing and using non-approved accessories, visit a qualified specialist workshop and inquire about:

- suitability
- legal stipulations
- factory recommendations

Information on dimensions and types of wheels and tires for your vehicle can be found (▷ page 340).

Information on air pressure for the tires on your vehicle can be found:

- on the vehicle's Tire and Loading Information placard on the B-pillar
- on the tire pressure label on the fuel filler flap
- under "Tire pressure"

- i** Further information on wheels and tires can be obtained at any qualified specialist workshop.

Operation

Information on driving

- If the vehicle is heavily loaded, check the tire pressures and correct them if necessary.
- While driving, pay attention to vibrations, noises and unusual handling characteristics, e.g. pulling to one side. This may indicate that the wheels or tires are damaged. If you suspect that a tire is defective, reduce your speed immediately. Stop the vehicle as soon as possible to check the wheels and tires for damage. Hidden tire damage could also be causing

the unusual handling characteristics. If you find no signs of damage, have the wheels and tires checked at a qualified specialist workshop.

- When parking your vehicle, make sure that the tires do not get deformed by the curb or other obstacles. If it is necessary to drive over curbs, speed humps or similar elevations, try to do so slowly and at an obtuse angle. Otherwise, the tires, particularly the sidewalls, may be damaged.

Regular checking of wheels and tires

WARNING

Damaged tires can cause tire inflation pressure loss. As a result, you could lose control of your vehicle. There is a risk of accident.

Check the tires regularly for signs of damage and replace any damaged tires immediately.

Regularly check the wheels and tires of your vehicle for damage at least once a month, as well as after driving off-road or on rough roads. Damaged wheels can cause a loss of tire pressure. Pay particular attention to damage such as:

- cuts in the tires
- punctures
- tears in the tires
- bulges on tires
- deformation or severe corrosion on wheels

Regularly check the tire tread depth and the condition of the tread across the whole width of the tire (▷ page 313). If necessary, turn the front wheels to full lock in order to inspect the inner side of the tire surface.

All wheels must have a valve cap to protect the valve against dirt and moisture. Do not mount anything onto the valve other than the standard valve cap or other valve caps approved by Mercedes-Benz for your vehicle.

Do not use any other valve caps or systems, e.g. tire pressure monitoring systems.

Regularly check the pressure of all the tires particularly prior to long trips. Adjust the tire pressure as necessary (▷ page 315).

The service life of tires depends, among other things, on the following factors:

- Driving style
- Tire pressure
- Distance covered

Important safety notes on the tire tread

WARNING

Insufficient tire tread will reduce tire traction. The tire is no longer able to dissipate water. This means that on wet road surfaces, the risk of hydroplaning increases, in particular where speed is not adapted to suit the driving conditions. There is a risk of accident.

If the tire pressure is too high or too low, tires may exhibit different levels of wear at different locations on the tire tread. Thus, you should regularly check the tread depth and the condition of the tread across the entire width of all tires.

Minimum tire tread depth for:

- Summer tires: $\frac{1}{8}$ in (3 mm)
- M+S tires: $\frac{1}{4}$ in (4 mm)

For safety reasons, replace the tires before the legally prescribed limit for the minimum tire tread depth is reached.

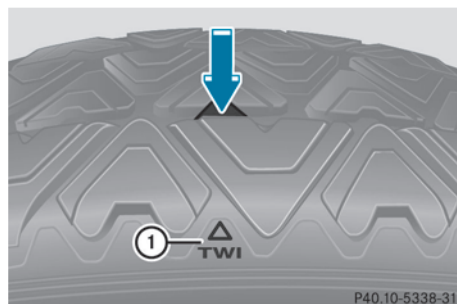

P40.10-5338-31

Bar indicator  for tread wear is integrated into the tire tread.

Treadwear indicators (TWI) are required by law. Six indicators are positioned on the tire tread. They are visible once the tread depth is approximately $\frac{1}{16}$ in (1.6 mm). If this is the case, the tire is so worn that it must be replaced.

Selecting, mounting and replacing tires

- Only mount tires and wheels of the same type and make.
Exception: it is permissible to install a different type or make in the event of a flat tire. Observe the "MOExtended tires (tires with run-flat characteristics)" section ([▷ page 295](#)).
- Only mount tires of the correct size onto the wheels.
- After mounting new tires, break them in at moderate speeds for the first 60 miles (100 km), as they only reach their full performance after this distance.
- Do not drive with tires which have too little tread depth, as this significantly reduces the traction on wet roads (hydroplaning).
- Replace the tires after six years at the latest, regardless of wear.

MOExtended tires (tires with run-flat properties)

With MOExtended tires (tires with run flat characteristics), you can continue to drive your vehicle even if there is a total loss of pressure in one or more tires.

MOExtended tires may only be used in conjunction with an active tire pressure loss warning system and only on wheels specifically tested by Mercedes-Benz.

Notes on driving with MOExtended tires with a flat tire ([▷ page 295](#)).

- **i** Vehicles equipped with MOExtended tires are not equipped with a TIREFIT kit at the factory. It is therefore recommended that you additionally equip your vehicle with a TIREFIT kit if you mount tires that do not feature run-flat properties, e.g. winter tires. A TIREFIT kit can be obtained from a qualified specialist workshop.

Winter operation

General notes

Have your vehicle winterproofed at a qualified specialist workshop at the onset of winter.

Observe the notes in the "Changing a wheel" section ([▷ page 336](#)).

Driving with summer tires

At temperatures below 45 °F (+7 °C), summer tires lose elasticity and therefore traction and braking power. Change the tires on your vehicle to M+S tires. Using summer tires at very cold temperatures could cause cracks to form, thereby damaging the tires permanently. Mercedes-Benz cannot accept responsibility for this type of damage.

M+S tires

WARNING

M+S tires with a tire tread depth of less than $\frac{1}{8}$ in (4 mm) are not suitable for use in winter and do not provide sufficient traction. There is a risk of an accident.

M+S tires with a tread depth of less than $\frac{1}{8}$ in (4 mm) must be replaced immediately.

At temperatures below 45 °F (+7 °C), use winter tires or all-season tires. Both types of tire are identified by the M+S marking.

Only winter tires bearing the  snowflake symbol in addition to the M+S marking provide the best possible grip in wintry road conditions. Only these tires will allow driving

safety systems such as ABS and ESP® to function optimally in winter. These tires have been developed specifically for driving in snow.

Use M+S tires of the same make and tread on all wheels to maintain safe handling characteristics.

Always observe the maximum permissible speed specified for the M+S tires you have mounted.

Once the winter tires are mounted:

- ▶ Check the tire pressures (▷ page 319).
- ▶ Restart the tire pressure loss warning system (▷ page 319).

For more information on driving with the emergency spare wheel, see (▷ page 342).

Snow chains

WARNING

If snow chains are mounted on the rear wheels, the snow chains could cause abrasion to the vehicle body or to chassis components. This could cause damage to the vehicle or the tires. There is a risk of an accident.

To avoid hazardous situations:

- never mount snow chains on the rear wheels
- only mount snow chains in pairs on the front wheels.

! On some tire sizes there is not enough space for snow chains. To avoid damage to the vehicle or tires, observe the "Wheel and tire combinations" section under "Tires and wheels".

For safety reasons, Mercedes-Benz recommends that you only use snow chains that have been specially approved for your vehicle by Mercedes-Benz, or are of a corresponding standard of quality.

If you intend to mount snow chains, please bear the following points in mind:

- Snow chains may not be mounted on all wheel/tire combinations. Permissible wheel-tire combinations (▷ page 340).
- Only use snow chains when driving on roads completely covered by snow. Remove the snow chains as soon as possible when you come to a road that is not snow-covered.
- Local regulations may restrict the use of snow chains. Observe the appropriate regulations if you wish to mount snow chains.
- Do not exceed the maximum permissible speed of 30 mph (50 km/h).
- When snow chains are installed, never use Active Parking Assist (▷ page 175).

i You can deactivate ESP® (▷ page 68) when pulling away with snow chains installed. You can thereby allow the wheels to spin in a controlled manner, achieving an increased driving force (cutting action).

Information about driving with an emergency spare wheel (▷ page 342).

Tire pressure

Tire pressure specifications

WARNING

Underinflated or overinflated tires pose the following risks:

- the tires may burst, especially as the load and vehicle speed increase.
- the tires may wear excessively and/or unevenly, which may greatly impair tire traction.
- the driving characteristics, as well as steering and braking, may be greatly impaired.

There is a risk of an accident.

Follow recommended tire inflation pressures and check the pressure of all the tires including the spare wheel:

- monthly, at least
- if the load changes
- before beginning a long journey
- under different operating conditions, e.g. off-road driving

If necessary, correct the tire pressure.

Use a suitable pressure gauge to check the tire pressure. The outer appearance of a tire does not permit any reliable conclusion about the tire pressure. On vehicles equipped with the electronic tire pressure monitor, the tire pressure can be checked in the on-board computer.

The recommended tire pressures for the tires mounted at the factory can be found on the labels described here.

1.) **Tire and Loading Information placard** on the B-pillar on the driver's side of the vehicle (▷ page 323).

The Tire and Loading Information placard contains the recommended tire pressures for cold tires. The recommended tire pressures are valid for the maximum permissible load and up to the maximum permissible vehicle speed.

TIRE LOADING INFORMATION		RENSEIGNEMENTS SUR LES PNEUS ET LE CHARGEMENT	
SEATING CAPACITY NOMBRE DE PLACES	TOTAL 7	FRONT AVANT 2	MIDDLE MILIEU 3
The combined weight of occupants and cargo should never exceed XXX kg or XXX lbs. The combined weight of occupants and cargo must never exceed XXX kg ou XXX lbs.			
TIRE PNEU	SIZE DIMENSIONS	COLD TIRE PRESSURE PRESSION DES PNEUS A FROID	SEE OWNER'S MANUAL FOR ADDITIONAL INFORMATION
FRONT AVANT	265/40 ZR18 99Y XL	200 kPa, 29 PSI	VOIR LE MANUEL DE L'USAGER POUR PLUS DE RENSEIGNEMENTS
REAR ARRIERE	285/35 ZR18 101Y XL	200 kPa, 29 PSI	
SPARE DE SECOURS	175/55-18 95P	420 kPa, 60 PSI	

P40.00-2205-31

① Recommended tire pressures

Option 2) **Tire pressure table** on the inside of the fuel filler flap.

The tire pressure table contains the recommended pressures for cold tires for

various operating conditions, i.e. differing load and speed conditions.

① Specifications shown in the examples of tire pressure tables are for illustration purposes only. Tire pressure specifications are vehicle-specific and may deviate from the data shown here. Tire pressure specifications applicable to your vehicle are located in your vehicle's tire pressure table.

COLD TIRE PRESSURE			
normal load	35 PSI	35 PSI	A 212 594 00 15 1234567
maximum load	35 PSI	35 PSI	
Warm tires up to: + 4 psi			

P40.00-2179-31

Example: tire pressure table for all tires permitted for this vehicle by the factory

If a tire size precedes a tire pressure, the tire pressure information following is only valid for that tire size. The load conditions "partially laden" and "fully laden" are defined in the table for different numbers of occupants and amounts of luggage. The actual number of seats may differ.

LUFTDRUCK PRESSURE PRESSION PRESSION							
für kalte Reifen		for cold tires		des pneus froids		de inflado	
100 kPa = 1 bar							
195/55 R16	30 PSI	30 PSI	30 PSI	30 PSI	30 PSI	30 PSI	30 PSI
215/45 R17	30 PSI	30 PSI	30 PSI	30 PSI	30 PSI	30 PSI	30 PSI
215/40 R18	30 PSI	30 PSI	30 PSI	30 PSI	30 PSI	30 PSI	30 PSI
Warme Reifen: Warm tires up to: + 30 kPa / + 4 psi				Pneus échauffés jusqu'à: Neumáticos calientes hasta:			

P40.00-2183-31

Example: tire pressure table with tire dimensions

Some tire pressure tables show only the rim diameters instead of the full tire size, e.g.

R18. Rim diameter is part of the tire size and

can be found on the tire sidewall
(▷ page 330).

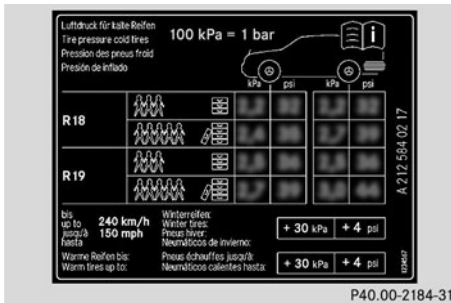

If the tire pressures have been set to the lower values for lighter loads and/or lower road speeds, the pressures should be reset to the higher values:

- if you want to drive with an increased load and/or
- if you want to drive at higher road speeds.

i The tire pressures for increased loads and/or higher road speeds, shown in the tire pressure table, may have a negative effect on driving comfort.

If the tire pressure is not set correctly, this can lead to an excessive build up of heat and a sudden loss of pressure.

For more information, contact a qualified specialist workshop.

Important notes on tire pressure

⚠ WARNING

If the tire pressure drops repeatedly, the wheel, valve or tire may be damaged. Tire pressure that is too low may result in a tire blow-out. There is a risk of an accident.

- Check the tire for foreign objects.
- Check whether the wheel is losing air or the valve is leaking.

If you are unable to rectify the damage, contact a qualified specialist workshop.

⚠ WARNING

If you fit unsuitable accessories onto tire valves, the tire valves may be overloaded and malfunction, which can cause tire pressure loss. Due to their design, retrofitted tire pressure monitors keep the tire valve open. This can also result in tire pressure loss. There is a risk of an accident.

Only screw the standard valve cap or other valve caps approved by Mercedes-Benz for your vehicle onto the tire valve.

Use a suitable pressure gauge to check the tire pressure. The outer appearance of a tire does not permit any reliable conclusion about the tire pressure.

The tire temperature and pressure increase when the vehicle is in motion. This is dependent on the driving speed and the load. Therefore, you should only correct tire pressures when the tires are cold.

The tires are cold:

- if the vehicle has been parked without direct sunlight on the tires for at least three hours and
- if the vehicle has not been driven further than 1 mile (1.6 km)

The tire temperature changes depending on the outside temperature, the vehicle speed and the tire load. If the tire temperature changes by 18 °F (10 °C), the tire pressure changes by approximately 10 kPa (0.1 bar/ 1.5 psi). Take this into account when checking the pressure of warm tires. Only correct the tire pressure if it is too low for the current operating conditions. If you check the tire pressure when the tires are warm, the resulting value will be higher than if the tires were cold. This is normal. Do not reduce the tire pressure to the value specified for cold tires. The tire pressure would otherwise be too low.

Observe the recommended tire pressures for cold tires:

- on the Tire and Loading Information placard on the B-pillar on the driver's side
- in the tire pressure table on the inside of the fuel filler flap

Underinflated or overinflated tires

Underinflation

WARNING

Tires with pressure that is too low can overheat and burst as a consequence. In addition, they also suffer from excessive and/or irregular wear, which can severely impair the braking properties and the driving characteristics. There is a risk of an accident.

Avoid tire pressures that are too low in all the tires, including the spare wheel.

Underinflated tires may:

- wear quickly and unevenly
- have an adverse effect on fuel consumption
- overheat, leading to tire defects
- have an adverse effect on handling characteristics

Overinflation

WARNING

Tires with excessively high pressure can burst because they are damaged more easily by road debris, potholes etc. In addition, they also suffer from irregular wear, which can severely impair the braking properties and the driving characteristics. There is a risk of an accident.

Avoid tire pressures that are too high in all the tires, including the spare wheel.

Overinflated tires may:

- have an adverse effect on handling characteristics
- wear quickly and unevenly

- be more susceptible to damage
- have an adverse effect on ride comfort
- increase the braking distance

Maximum tire pressures

Never exceed the maximum permissible tire inflation pressure. Always observe the recommended tire pressure for your vehicle when adjusting the tire pressure (> page 315).

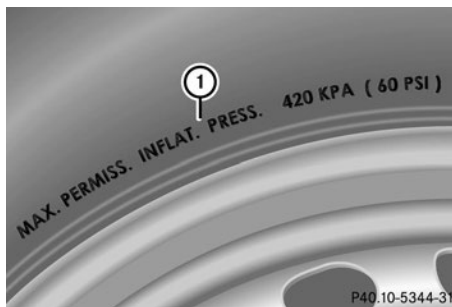

① Example: maximum permissible tire pressure

i The actual values for tires are vehicle-specific and may deviate from the values in the illustration.

Checking the tire pressures

Important safety notes

Observe the "Tire pressure information" section (> page 315).

Information on air pressure for the tires on your vehicle can be found:

- on the vehicle's Tire and Loading Information placard on the B-pillar
- on the tire pressure label on the fuel filler flap
- in the "Tire pressure information" section

Checking tire pressures manually

To determine and set the correct tire pressure, proceed as follows:

- ▶ Remove the valve cap of the tire that is to be checked.
- ▶ Press the tire pressure gauge securely onto the valve.
- ▶ Read the tire pressure and compare it with the recommended value on the Tire and Loading Information placard on the B-pillar on the driver's side of your vehicle.
- ▶ If necessary, increase the tire pressure to the recommended value (> page 315).
- ▶ If the tire pressure is too high, release air by pressing down the metal pin in the valve using the tip of a pen, for example. Then, check the tire pressure again using the tire pressure gauge.
- ▶ Screw the valve cap onto the valve.
- ▶ Repeat these steps for the other tires.

Tire pressure loss warning system

General notes

While the vehicle is in motion, the tire pressure loss warning system monitors the set tire pressure using the rotational speed of the wheels. This enables the system to detect significant pressure loss in a tire. If the speed of rotation of a wheel changes as a result of a loss of pressure, a corresponding warning message will appear in the multifunction display.

You can recognize the tire pressure loss warning by the **Run Flat Indicator Active Press 'OK' to Restart** message which appears in the **Service** menu of the multifunction display. Further information on the message display can be found under "Restarting the tire pressure loss warning system" (> page 319).

Important safety notes

The tire pressure warning system does not warn you of an incorrectly set tire pressure. Observe the notes on the recommended tire pressure (> page 315).

The tire pressure loss warning does not replace the need to regularly check the tire pressure. An even loss of pressure on several tires at the same time cannot be detected by the tire pressure loss warning system.

The tire pressure monitor is not able to warn you of a sudden loss of pressure, e.g. if the tire is penetrated by a foreign object. In the event of a sudden loss of pressure, bring the vehicle to a halt by braking carefully. Avoid abrupt steering maneuvers.

The function of the tire pressure loss warning system is limited or delayed if:

- snow chains are mounted on your vehicle's tires.
- road conditions are wintry.
- you are driving on sand or gravel.
- you adopt a very sporty driving style (cornering at high speeds or driving with high rates of acceleration).
- you are driving with a heavy load (in the vehicle or on the roof).





Restarting the tire pressure loss warning system

Restart the tire pressure loss warning system if you have:





- changed the tire pressure
- changed the wheels or tires
- mounted new wheels or tires
- ▶ Before restarting, make sure that the tire pressures are set properly on all four tires for the respective operating conditions.

The recommended tire pressure can be found on the Tire and Loading Information placard on the B-pillar on the driver's side. Additionally, a tire pressure table is attached to the fuel filler flap. The tire

pressure loss warning system can only give reliable warnings if you have set the correct tire pressure. If an incorrect tire pressure is set, these incorrect values will be monitored.





- ▶ Also observe the notes in the section on tire pressures (▷ page 315).
- ▶ Make sure that the SmartKey is in position 2 in the ignition lock (▷ page 137).
- ▶ Press  or  on the steering wheel to select the **Service** menu.
- ▶ Press the  or  button to select **Tire Pressure**.
- ▶ Press the  button.
The **Run Flat Indicator Active Press 'OK' to Restart** message appears in the multifunction display.

If you wish to confirm the restart:

- ▶ Press the  button.
The **Tire Pressure Now OK?** message appears in the multifunction display.
- ▶ Press the  or  button to select **Yes**.
- ▶ Press the  button.
The **Run Flat Indicator Restarted** message appears in the multifunction display.

After a teach-in period, the tire pressure loss warning system will monitor the set tire pressures of all four tires.

If you wish to cancel the restart:

- ▶ Press the  button.
or
- ▶ When the **Tire Pressure Now OK?** message appears, press the  or  button to select **Cancel**.
- ▶ Press the  button.
The tire pressure values stored at the last restart will continue to be monitored.

Tire pressure monitor

General notes

If a tire pressure monitor is installed, the vehicle's wheels have sensors that monitor the tire pressures in all four tires. The tire pressure monitor warns you if the pressure drops in one or more of the tires. The tire pressure monitor only functions if the correct sensors are installed on all wheels.

Information on tire pressures is displayed in the multifunction display. After a few minutes of driving, the current tire pressure of each tire is shown in the **Service** menu of the multifunction display.

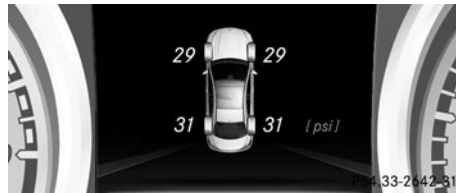

Example: current tire pressure display

For information on the message display, refer to the "Checking the tire pressure electronically" section (▷ page 322).

Important safety notes

WARNING

Each tire, including the spare (if provided), should be checked at least once every two weeks when cold and inflated to the pressure recommended by the vehicle manufacturer on the Tire and Loading Information placard on the driver's door B-pillar or the tire pressure label on the inside of the fuel filler flap. If your vehicle has tires of a different size than the size indicated on the Tire and Loading Information placard or, if available, the tire pressure label, you should determine the proper tire pressure for those tires.

As an added safety feature, your vehicle has been equipped with a tire pressure monitoring system (TPMS) that illuminates a low tire pressure telltale when one or more of your

tires are significantly underinflated. Accordingly, when the low tire pressure telltale lights up, you should stop and check your tires as soon as possible, and inflate them to the proper pressure. Driving on a significantly underinflated tire causes the tire to overheat and can lead to tire failure.

Underinflation also reduces fuel efficiency and tire tread life, and may affect the vehicle's handling and stopping ability. Please note that the TPMS is not a substitute for proper tire maintenance, and it is the driver's responsibility to maintain correct tire pressure, even if underinflation has not reached the level to trigger illumination of the TPMS low tire pressure telltale.

Your vehicle has also been equipped with a TPMS malfunction indicator to indicate when the system is not operating properly. The TPMS malfunction indicator is combined with the low tire pressure telltale. When the system detects a malfunction, the warning lamp will flash for approximately a minute and then remain continuously illuminated. This sequence will be repeated every time the vehicle is started as long as the malfunction exists. When the malfunction indicator is illuminated, the system may not be able to detect or signal low tire pressure as intended. TPMS malfunctions may occur for a variety of reasons, including the installation of incompatible replacement or alternate tires or wheels on the vehicle that prevent the TPMS from functioning properly. Always check the TPMS malfunction telltale after replacing one or more tires or wheels on your vehicle to ensure that the replacement or alternate Tires and wheels allow the TPMS to continue to function properly.

It is the driver's responsibility to set the tire pressure to that recommended for cold tires which is suitable for the operating situation (> page 315). Note that the correct tire pressure for the current operating situation must first be taught-in to the tire pressure monitor. If there is a substantial loss of

pressure, the warning threshold for the warning message is aligned to the reference values taught-in. Restart the tire pressure monitor after adjusting the pressure of the cold tires (> page 322). The current pressures are saved as new reference values. As a result, a warning message will appear if the tire pressure drops significantly.

The tire pressure monitor does not warn you of an incorrectly set tire pressure. Observe the notes on the recommended tire pressure (> page 315).

The tire pressure monitor is not able to warn you of a sudden loss of pressure, e.g. if the tire is penetrated by a foreign object. In the event of a sudden loss of pressure, bring the vehicle to a halt by braking carefully. Avoid abrupt steering maneuvers.

The tire pressure monitor has a yellow warning lamp in the instrument cluster for indicating a pressure loss or malfunction. Whether the warning lamp flashes or lights up indicates whether a tire pressure is too low or the tire pressure monitor is malfunctioning:

- if the warning lamp is lit continuously, the tire pressure on one or more tires is significantly too low. The tire pressure monitor is not malfunctioning.
- if the warning lamp flashes for around a minute and then remains lit constantly, the tire pressure monitor is malfunctioning.

i In addition to the warning lamp, a message appears in the multifunction display.

Further information can be found on (> page 231).

If the tire pressure monitor is malfunctioning, it may take more than ten minutes for the tire pressure warning lamp to inform you of the malfunction by flashing for approximately one minute and then remaining lit. When the malfunction has been rectified, the tire pressure warning lamp goes out after a few minutes of driving.

The tire pressure values indicated by the on-board computer may differ from those measured at a gas station with a pressure gauge. The tire pressures shown by the on-board computer refer to those measured at sea level. At high altitudes, the tire pressure values indicated by a pressure gauge are higher than those shown by the on-board computer. In this case, do not reduce the tire pressures.

The operation of the tire pressure monitor can be affected by interference from radio transmitting equipment (e.g. radio headphones, two-way radios) that may be being operated in or near the vehicle.

Checking the tire pressure electronically

- ▶ Make sure that the SmartKey is in position 2 in the ignition lock (▷ page 137).
- ▶ Press the ◀ or ▶ button on the steering wheel to select the **Service** menu.
- ▶ Press the ▲ or ▼ button to select **Tire Pressure**.
- ▶ Press the **OK** button.

The current tire pressure of each tire is shown in the multifunction display.

If the vehicle has been parked for longer than 20 minutes, the **Tire pressure will be displayed after driving a few minutes** message appears.

After a teach-in process, the tire pressure monitor automatically detects new wheels or new sensors. As long as a clear allocation of the tire pressure value to the individual wheels is not possible, the **Tire Pressure Monitor Active** message is shown instead of the tire pressure display. The tire pressures are already being monitored.

Tire pressure monitor warning messages

If the tire pressure monitor detects a pressure loss in one or more tires, a warning message is shown in the multifunction display and the yellow tire pressure monitor warning light comes on.

- If the **Please Correct Tire Pressure** message appears in the multifunction display, the tire pressure in at least one tire is too low and must be corrected at the next opportunity.
- If the **Check Tire Pressure Soon** message appears in the multifunction display, the tire pressure in one or more tires has dropped significantly and the tires must be checked.
- If the **Tire Pressure Warning Tire Failure** message appears in the multifunction display, the tire pressure in one or more tires has dropped suddenly and the tires must be checked.

Observe the instructions and safety notes in the display messages in the "Tires" section (▷ page 231).





- ❗ If the wheel positions on the vehicle are rotated, the tire pressures may be displayed for the wrong positions for a short time. This is rectified after a few minutes of driving, and the tire pressures are displayed for the correct positions.

Restarting the tire pressure monitor

When you restart the tire pressure monitor, all existing warning messages are deleted and the warning lamps go out. The monitor uses the currently set tire pressures as the reference values for monitoring. In most cases, the tire pressure monitor will automatically detect the new reference values after you have changed the tire pressure. However, you can also define reference values manually as described here. The tire pressure monitor then monitors the new tire pressure values.

- ▶ Set the tire pressure to the value recommended for the corresponding driving situation on the Tire and Loading Information placard on the driver's side B-pillar (▷ page 315).

Additional tire pressure values for different loads can also be found on the tire pressure table on the inside of the fuel filler flap (▷ page 315).

- ▶ Make sure that the tire pressure is correct on all four wheels.
- ▶ Make sure that the SmartKey is in position **2** in the ignition lock.
- ▶ Press  or  on the steering wheel to select the **Service** menu.
- ▶ Press the  or  button to select **Tire Pressure**.
- ▶ Press the  button.

The multifunction display shows the current tire pressure for the individual tires or the **Tire pressures will be displayed after driving a few minutes** message.

- ▶ Press the  button.
- The **Use Current Pressures as New Reference Values** message appears in the multifunction display.

If you wish to confirm the restart:

- ▶ Press the  button.
- The **Tire Pressure Monitor Restarted** message appears in the multifunction display.

After driving for a few minutes, the system checks whether the current tire pressures are within the specified range. The new tire pressures are then accepted as reference values and monitored.

If you wish to cancel the restart:

- ▶ Press the  button.
- The tire pressure values stored at the last restart will continue to be monitored.

Loading the vehicle

Instruction labels for tires and loads

WARNING

Overloaded tires can overheat, causing a blowout. Overloaded tires can also impair the steering and driving characteristics and lead to brake failure. There is a risk of accident.

Observe the load rating of the tires. The load rating must be at least half of the GAWR of your vehicle. Never overload the tires by exceeding the maximum load.

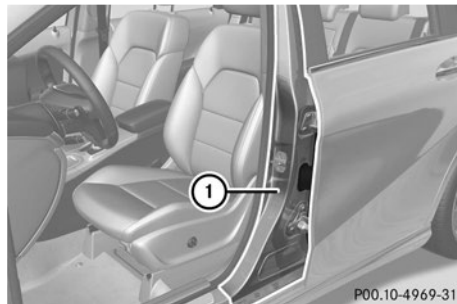

① B-pillar, driver's side

Two instruction labels on your vehicle show the maximum possible load.

- (1) The Tire and Loading Information placard is on the B-pillar on the driver's side. The Tire and Loading Information placard shows the maximum permissible number of occupants and the maximum permissible vehicle load. It also contains details of the tire sizes and corresponding pressures for tires mounted at the factory.
- (2) The vehicle identification plate is on the B-pillar on the driver's side. The vehicle identification plate informs you of the gross vehicle weight rating. It is made up of the vehicle weight, all vehicle occupants, the fuel and the cargo. You can also find information about the maximum gross axle weight rating on the front and rear axle.

The maximum gross axle weight rating is the maximum weight that can be carried by one axle (front or rear axle). Never exceed the maximum load or the maximum gross axle weight rating for the front or rear axle.

Maximum permissible gross vehicle weight rating

TIRE RENSEIGNEMENTS SUR LES PNEUS ET LE CHARGEMENT		① LOADING INFORMATION		
SEATING CAPACITY NOMBRE DE PLACES	TOTAL	FRONT AVANT	MIDDLE MILIEU	REAR ARRIERE
The combined weight of occupants and cargo should never exceed XXX kg or XXX lbs. Le poids total des occupants et du chargement ne doit jamais dépasser XXX kg ou XXX lbs.*				
TIRE PNEU	SIZE DIMENSIONS	COLD TIRE PRESSURE PRESSION DES PNEUS À FROID		SEE OWNER'S MANUAL FOR ADDITIONAL INFORMATION
FRONT AVANT	255/40 ZR18 99Y XL	200 KPA, 29 PSI		VOIR LE MANUEL DE L'USAGER POUR PLUS DE RENSEIGNEMENTS
REAR ARRIERE	285/35 ZR18 101Y XL	200 KPA, 29 PSI		
SPARE DE SECOURS	175/55-18 95P	420 KPA, 60 PSI		

P40.00-2206-31

- Specification for maximum gross vehicle weight ① is listed in the Tire and Loading Information placard: "The combined weight of occupants and cargo should never exceed XXX kilograms or XXX lbs."

The gross weight of all vehicle occupants, load, luggage and trailer load/noseweight (if applicable) must not exceed the specified value.

- ① The specifications shown on the Tire and Loading Information placard in the illustration are examples. The maximum permissible load is vehicle-specific and may deviate from the data shown here. The maximum permissible load that applies for your vehicle can be found on your vehicle's Tire and Loading Information placard.

Number of seats

TIRE RENSEIGNEMENTS SUR LES PNEUS ET LE CHARGEMENT		① LOADING INFORMATION		
SEATING CAPACITY NOMBRE DE PLACES	TOTAL	FRONT AVANT	MIDDLE MILIEU	REAR ARRIERE
The combined weight of occupants and cargo should never exceed XXX kg or XXX lbs. Le poids total des occupants et du chargement ne doit jamais dépasser XXX kg ou XXX lbs.*				
TIRE PNEU	SIZE DIMENSIONS	COLD TIRE PRESSURE PRESSION DES PNEUS À FROID		SEE OWNER'S MANUAL FOR ADDITIONAL INFORMATION
FRONT AVANT	255/40 ZR18 99Y XL	200 KPA, 29 PSI		VOIR LE MANUEL DE L'USAGER POUR PLUS DE RENSEIGNEMENTS
REAR ARRIERE	285/35 ZR18 101Y XL	200 KPA, 29 PSI		
SPARE DE SECOURS	175/55-18 95P	420 KPA, 60 PSI		

P40.00-2207-31

Maximum number of seats ① indicates the maximum number of occupants allowed to travel in the vehicle. This information can be found on the Tire and Loading Information placard.

- ① The specifications shown on the Tire and Loading Information placard in the illustration are examples. The number of seats is vehicle-specific and can differ from the details shown. The number of seats in your vehicle can be found on the Tire and Loading Information placard.

Determining the correct load limit

Step-by-step instructions

The following steps have been developed as required of all manufacturers under Title 49, Code of U.S. Federal Regulations, Part 575 pursuant to the "National Traffic and Motor Vehicle Safety Act of 1966".

- **Step 1:** Locate the statement "The combined weight of occupants and cargo should never exceed XXX kg or XXX lbs." on your vehicle's Tire and Loading Information placard.
- **Step 2:** Determine the combined weight of the driver and passengers that will be riding in your vehicle.
- **Step 3:** Subtract the combined weight of the driver and passengers from XXX kilograms or XXX lbs.

- ▶ **Step 4:** The resulting figure equals the available amount of cargo and luggage load capacity. For example, if the "XXX" amount equals 1400 lbs and there are five occupants in the vehicle each with a weight of 150 lbs, the amount of available cargo and luggage load capacity is 650 lbs ($1400 - 750 (5 \times 150) = 650$ lbs).
- ▶ **Step 5:** Determine the combined weight of luggage and cargo being loaded on the vehicle. That weight may not safely exceed the available cargo and luggage load capacity calculated in step 4.
- ▶ **Step 6 (if applicable):** If your vehicle will be towing a trailer, load from your trailer will be transferred to your vehicle. Refer to this Operator's Manual to determine how this reduces the available cargo and luggage load capacity of your vehicle (▷ page 327).

Example: steps 1 to 3

The following table shows examples on how to calculate total and cargo load capacities with varying seating configurations and number and size of occupants. The following examples use a maximum load of 1500 lbs (680 kg). **This is for illustration purposes only.** Make sure you are using the actual load limit for your vehicle stated on your vehicle's Tire and Loading Information placard (> page 324).

The greater the combined weight of the occupants, the lower the maximum luggage load.

		Example 1	Example 2	Example 3
Step 1	Combined maximum weight of occupants and cargo (data from the Tire and Loading Information placard)	1500 lbs (680 kg)	1500 lbs (680 kg)	1500 lbs (680 kg)

		Example 1	Example 2	Example 3
Step 2	Number of people in the vehicle (driver and occupants)	5	3	1
	Distribution of the occupants	Front: 2 Rear: 3	Front: 1 Rear: 2	Front: 1
	Weight of the occupants	Occupant 1: 150 lbs (68 kg) Occupant 2: 180 lbs (82 kg) Occupant 3: 160 lbs (73 kg) Occupant 4: 140 lbs (63 kg) Occupant 5: 120 lbs (54 kg)	Occupant 1: 200 lbs (91 kg) Occupant 2: 190 lbs (86 kg) Occupant 3: 150 lbs (68 kg)	Occupant 1: 150 lbs (68 kg)
	Gross weight of all occupants	750 lbs (340 kg)	540 lbs (245 kg)	150 lbs (68 kg)

		Example 1	Example 2	Example 3
Step 3	Permissible load and trailer load/noseweight (maximum permissible load rating from the Tire and Loading Information placard minus the gross weight of all occupants)	1500 lbs (680 kg) -750 lbs (340 kg) = 750 lbs (340 kg)	1500 lbs (680 kg) -540 lbs (245 kg) = 960 lbs (435 kg)	1500 lbs (680 kg) -150 lbs (68 kg) = 1350 lbs (612 kg)

Vehicle identification plate

Even if you have calculated the total cargo carefully, you should still make sure that the gross vehicle weight rating and the gross axle weight rating are not exceeded. Details can be found on the vehicle identification plate on the B-pillar on the driver's side of the vehicle (▷ page 323).

Permissible gross vehicle weight: the gross weight of the vehicle, all passengers, load and trailer load/noseweight (if applicable) must not exceed the permissible gross vehicle weight.

Gross axle weight rating: the maximum permissible weight that can be carried by one axle (front or rear axle).

To ensure that your vehicle does not exceed the maximum permissible values (gross vehicle weight and maximum gross axle weight rating), have your loaded vehicle (including driver, occupants, cargo, and full trailer load if applicable) weighed on a suitable vehicle weighbridge.

Trailer load/noseweight

The trailer load/noseweight affects the gross weight of the vehicle. If a trailer is attached, the trailer load/noseweight is included in the load along with occupants and luggage. The trailer load/noseweight is usually between

10% and 15% of the gross weight of the trailer and its load.

Maximum load rating

Do not overload the tires by exceeding the specified load limit. The maximum permissible load can be found on the vehicle's Tire and Loading Information placard on the B-pillar on the driver's side (▷ page 323).



Maximum tire load ① is the maximum permissible weight for which the tire is approved.

i The actual values for tires are vehicle-specific and may deviate from the values in the illustration.

Uniform Tire Quality Grading Standards

Overview of Tire Quality Grading Standards

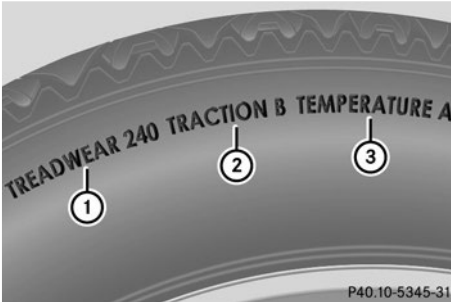

Uniform Tire Quality Grading Standards are U.S. government specifications. Their purpose is to provide drivers with uniform reliable information on tire performance data. Tire manufacturers have to grade tires using three performance factors: tread wear ①, tire traction ②, and heat resistance ③. These regulations do not apply to Canada. Nevertheless, all tires sold in North America are provided with the corresponding quality grading markings on the sidewall of the tire. All passenger car tires must conform to the statutory safety requirements in addition to these grades.

Where applicable, the tire grading information can be found on the tire sidewall between the tread shoulder and maximum tire width.

i The actual values for tires are vehicle-specific and may deviate from the values in the illustration.

For example:

Treadwear	Traction	Temperature
200	AA	A

Treadwear

The treadwear grade is a comparative rating based on the wear rate of the tire when tested under controlled conditions on a specified U.S. government course. For example, a tire graded 150 would wear one and one-half times as well on the government course as a tire graded 100.

The relative performance of tires depends upon the actual conditions of their use, however, and may depart significantly from the norm, due to variations in driving habits, service practices and differences in road characteristics and climate conditions.

Traction

⚠ WARNING

The traction grade assigned to this tire is based on straight-ahead braking traction tests, and does not include acceleration, cornering, hydroplaning, or peak traction characteristics.

The traction grades, from highest to lowest, are AA, A, B, and C. Those grades represent the tire's ability to stop on a wet surface as measured under controlled conditions on specified government test surfaces of asphalt and concrete. A tire marked C may have poor traction performance.

The safe speed on a wet, snow covered or icy road is always lower than on dry road surfaces.

You should pay special attention to road conditions when temperatures are around the freezing point.

Mercedes-Benz recommends a minimum tread depth of $\frac{1}{8}$ in (4 mm) for all four winter tires (> page 314) to maintain normal driving characteristics in winter. Winter tires can reduce the braking distance on snow-covered surfaces in comparison with summer tires. Stopping distance, however, is still considerably greater than when the road is

not covered with ice or snow. Take appropriate care when driving.

- ❗ Avoid wheelspin. This can lead to damage to the drive train.

Temperature

⚠ WARNING

The temperature grade for this tire is established for a tire that is properly inflated and not overloaded. Excessive speed, underinflation, or excessive loading, either separately or in combination, can cause excessive heat build-up and possible tire failure.

The temperature grades are A (the highest), B, and C. These represent the tire's resistance to the generation of heat and its ability to dissipate heat when tested under controlled conditions on a specified indoor laboratory test wheel. Sustained high temperature can cause the material of the tire to degenerate and reduce tire life, and excessive temperature can lead to sudden tire failure. The grade C corresponds to a level of performance which all passenger car tires must meet under the Federal Motor Vehicle Safety Standard No. 109. Grades B and A represent higher levels of performance on the laboratory test wheel than the minimum required by law.

Tire labeling

Overview of tire labeling

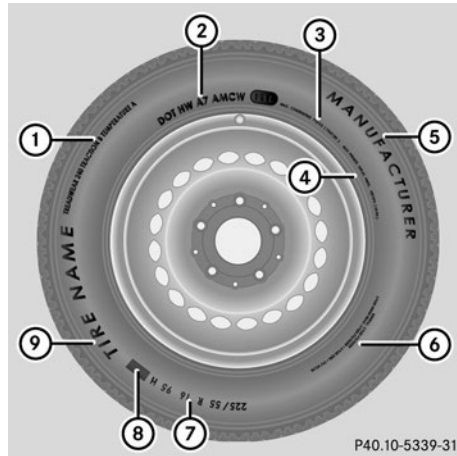

The following markings are on the tire in addition to the tire name (sales designation) and the manufacturer's name:

- ① Uniform tire Quality Grading Standard (▷ page 333)
 - ② DOT, Tire Identification Number (▷ page 332)
 - ③ Maximum tire load (▷ page 327)
 - ④ Maximum tire pressure (▷ page 318)
 - ⑤ Manufacturer
 - ⑥ Tire material (▷ page 333)
 - ⑦ Tire size designation, load-bearing capacity and speed index (▷ page 330)
 - ⑧ Load index (▷ page 332)
 - ⑨ Tire name
- ❗ Tire data is vehicle-specific and may deviate from the data in the example.

P40.10-5339-31

Tire size designation, load-bearing capacity and speed rating

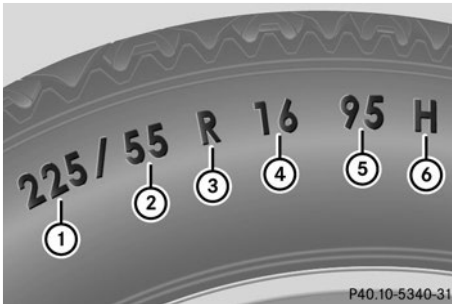

- ① Tire width
- ② Nominal aspect ratio in %
- ③ Tire code
- ④ Rim diameter
- ⑤ Load bearing index
- ⑥ Speed rating

i Tire data is vehicle-specific and may deviate from the data in the example.

General: depending on the manufacturer's standards, the size imprinted in the tire wall may not contain any letters or may contain one letter that precedes the size description.

If there is no letter preceding the size description (as shown above): these are passenger vehicle tires according to European manufacturing standards.

If "P" precedes the size description: these are passenger vehicle tires according to U.S. manufacturing standards.

If "LT" precedes the size description: these are light truck tires according to U.S. manufacturing standards.

If "T" precedes the size description: these are compact emergency spare wheels at high tire pressure, to be used only temporarily in an emergency.

Tire width: tire width ① shows the nominal tire width in millimeters.

Nominal aspect ratio: aspect ratio ② is the size ratio between the tire height and the tire width and is shown in percent. The aspect

ratio is calculated by dividing the tire width by the tire height.

Tire code: tire code ③ specifies the tire type. "R" represents radial tires; "D" represents diagonal tires; "B" represents diagonal radial tires.

Optionally, tires with a maximum speed of over 149mph (240km/h) may have "ZR" in the size description, depending on the manufacturer (e.g. 245/40 ZR 18).

Rim diameter: rim diameter ④ is the diameter of the bead seat, not the diameter of the rim flange. The rim diameter is specified in inches (in).

Load bearing index: load bearing index ⑤ is a numerical code which specifies the maximum load-bearing capacity of a tire.

Do not overload the tires by exceeding the specified load limit. The maximum permissible load can be found on the vehicle's Tire and Loading Information placard on the B-pillar on the driver's side (▷ page 323).

Example:

A load-bearing index of 91 indicates a maximum load of 1,356lb (615kg) that can be carried by the tires. For further information on the maximum tire load in kilograms and pounds, see (▷ page 327).

For further information on the load-bearing index, see Load index (▷ page 332).

Speed rating: speed rating ⑥ specifies the approved maximum speed of the tire.

⚠ WARNING



Exceeding the stated tire load-bearing capacity and the approved maximum speed could lead to tire damage or the tire bursting. There is a risk of accident.

Therefore, only use tire types and sizes approved for your vehicle model. Observe the tire load rating and speed rating required for your vehicle.

Regardless of the speed rating, always observe the speed limits. Drive carefully and



adapt your driving style to the traffic conditions.

Summer tires	
Index	Speed rating
Q	up to 100mph (160 km/h)
R	up to 106mph (170 km/h)
S	up to 112mph (180 km/h)
T	up to 118mph (190 km/h)
H	up to 130mph (210 km/h)
V	up to 149mph (240 km/h)
W	up to 168mph (270 km/h)
Y	up to 186mph (300 km/h)
ZR...Y	up to 186mph (300 km/h)
ZR...(..Y)	over 186mph (300 km/h)
ZR	over 149mph (240 km/h)

- Optionally, tires with a maximum speed of over 149 mph (240km/h) may have "ZR" in the size description, depending on the manufacturer (e.g. 245/40 ZR 18). The service specifications consist of load bearing index  and speed rating .
- If the size description of your tire includes "ZR" and there are no service specifications, ask the tire manufacturer in order to find out the maximum speed. If a service specification is available, the maximum speed is limited according to the speed rating in the service specification. Example: 245/40 ZR 18 97 Y. In this example, "97 Y" is the service specification. The letter "Y" represents the speed rating and the maximum speed of the tire is limited to 186 mph (300km/h).
- The size description for all tires with maximum speeds of over 186mph (300km/h) must include "ZR", **and** the

service specification must be given in brackets. Example: 275/40 ZR 18 (99 Y). The speed rating "(Y)" indicates that the maximum speed of the tire is over 186mph (300km/h). Ask the tire manufacturer about the maximum speed.

All-weather tires and winter tires	
Index	Speed rating
Q M+S ⁴	up to 100mph (160 km/h)
T M+S ⁴	up to 118mph (190 km/h)
H M+S ⁴	up to 130mph (210 km/h)
V M+S ⁴	up to 149mph (240 km/h)

-  Not all tires with the M+S marking provide the driving characteristics of winter tires. Winter tires have, in addition to the M+S identification, the  snowflake symbol on the tire sidewall. Tires with this marking fulfill the requirements of the Rubber Manufacturers Association (RMA) and the Rubber Association of Canada (RAC) regarding the tire traction on snow. They have been especially developed for driving on snow.

An electronic speed limiter prevents your vehicle from exceeding a speed of 130mph (210km/h).

The speed rating of tires mounted at the factory may be higher than the maximum speed that the electronic speed limiter permits.

Make sure that your tires have the required speed rating, e.g. when buying new tires. The required speed rating for your vehicle can be found in the "Tires" section (▷ page 340).

Further information about reading tire data can be obtained from any qualified specialist workshop.

⁴ Or M+S  for winter tires.

Load index



In addition to the load bearing index, load index ① may be imprinted after the letters that identify speed index ⑥ (▷ page 330) on the sidewall of the tire.

- If no specification is given: no text (as in the example above), represents a standard load (SL) tire
- XL or Extra Load: represents a reinforced tire
- Light Load: represents a light load tire
- C, D, E: represents a load range that depends on the maximum load that the tire can carry at a certain pressure

i Tire data is vehicle-specific and may deviate from the data in the example.

DOT, Tire Identification Number (TIN)

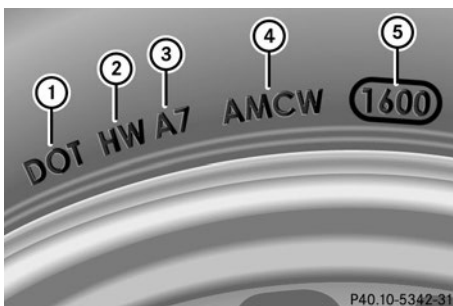

Canadian tire regulations prescribe that every new tire manufacturer or retreader has to imprint a TIN in or on the sidewall of each tire produced.

The TIN is a unique identification number. The TIN makes it easier for tire manufacturers or retreaders to notify customers of recalls or other safety-related matters. It makes it possible for the purchaser to easily identify the affected tires.

The TIN consists of the manufacturer identification code ②, tire size ③, tire type code ④ and manufacturing date ⑤.

DOT (Department of Transportation): tire symbol ① indicates that the tire complies with the requirements of the Canadian Transport Ministry.

Manufacturer identification code: manufacturer identification code ② provides details on the tire manufacturer. New tires have a code with two symbols. Retreaded tires have a code with four symbols.

Further information about retreaded tires (▷ page 312).

Tire size: identifier ③ describes the tire size.

Tire type code: tire type code ④ can be used by the manufacturer as a code to describe specific characteristics of the tire.

Date of manufacture: date of manufacture ⑤ provides information about the age of a tire. The first and second positions represent the week of manufacture, starting with "01" for the first calendar week. Positions three and four represent the year of manufacture. For example, a tire that is marked with "3208", was manufactured in week 32 in 2008.

i Tire data is vehicle-specific and may deviate from the data in the example.

Tire characteristics

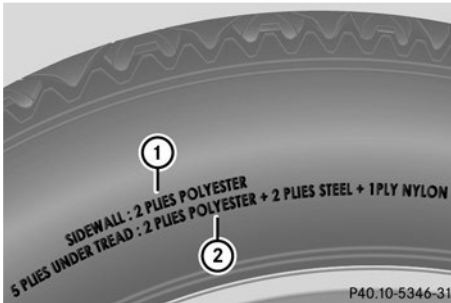

This information describes the tire cord and the number of layers in sidewall ① and under tire tread ②.

i Tire data is vehicle-specific and may deviate from the data in the example.

Definition of terms for tires and loading

Tire ply composition and material used

Describes the number of plies or the number of layers of rubber-coated fabric in the tire tread and sidewall. These are made of steel, nylon, polyester and other materials.

Bar

Metric unit for tire pressure. 14.5038 pounds per square inch (psi) and 100 kilopascals (kPa) are the equivalent of 1 bar.

DOT (Department of Transportation)

DOT marked tires fulfill the requirements of the Canadian Transport Ministry.

Normal occupant weight

The number of occupants for which the vehicle is designed multiplied by 68 kilograms (150 lb).

Uniform Tire Quality Grading Standards

A uniform standard to grade the quality of tires with regards to tread quality, tire traction and temperature characteristics. Ratings are determined by tire manufacturers using U.S. government testing procedures. The ratings are molded into the sidewall of the tire.

Recommended tire pressure

The recommended tire pressure applies to the tires mounted at the factory.

The Tire and Loading Information placard contains the recommended tire pressures for cold tires on a fully loaded vehicle and for the maximum permissible vehicle speed.

The tire pressure table contains the recommended pressures for cold tires for various operating conditions, i.e. differing load and speed conditions.

Increased vehicle weight due to optional equipment

This is the combined weight of all standard and optional equipment available for the vehicle, regardless of whether it is actually installed on the vehicle or not.

Rim

This is the part of the wheel on which the tire is mounted.

GAWR (Gross Axle Weight Rating)

The GAWR is the maximum gross axle weight rating. The actual load on an axle must never exceed the gross axle weight rating. The gross axle weight rating can be found on the vehicle identification plate on the B-pillar on the driver's side.

Speed rating

The speed rating is part of the tire identification. It specifies the speed range for which the tire is approved.

GVW (Gross Vehicle Weight)

The gross vehicle weight includes the weight of the vehicle including fuel, tools, the spare wheel, accessories installed, occupants, luggage and the drawbar noseweight, if applicable. The gross vehicle weight must not exceed the gross vehicle weight rating GVWR as specified on the vehicle identification plate on the B-pillar on the driver's side.

GVWR (Gross Vehicle Weight Rating)

The GVWR is the maximum permissible gross weight of a fully loaded vehicle (the weight of the vehicle including all accessories, occupants, fuel, luggage and the drawbar noseweight, if applicable). The gross vehicle weight rating is specified on the vehicle identification plate on the B-pillar on the driver's side.

Maximum loaded vehicle weight

The maximum weight is the sum of:

- the curb weight of the vehicle
- the weight of the accessories
- the load limit
- the weight of the factory installed optional equipment

Kilopascal (kPa)

Metric unit for tire pressure. 6.9 kPa corresponds to 1 psi. Another unit for tire pressure is bar. 100 kilopascal (kPa) is the equivalent of 1 bar.

Load index

In addition to the load-bearing index, the load index may also be imprinted on the sidewall of the tire. This specifies the load-bearing capacity more precisely.

Curb weight

The weight of a vehicle with standard equipment including the maximum capacity of fuel, oil and coolant. It also includes the air-conditioning system and optional equipment if these are installed in the vehicle, but does not include passengers or luggage.

Maximum load rating

The maximum load rating in kilograms or pounds is the maximum weight for which a tire is approved.

Maximum permissible tire pressure

Maximum permissible tire pressure for one tire.

Maximum load on one tire

Maximum load on one tire. This is calculated by dividing the maximum axle load of one axle by two.

PSI (pounds per square inch)

A standard unit of measure for tire pressure.

Aspect ratio

Relationship between tire height and tire width in percent.

Tire pressure

This is pressure inside the tire applying an outward force to each square inch of the tire's surface. The tire pressure is specified in pounds per square inch (psi), in kilopascal (kPa) or in bar. The tire pressure should only be corrected when the tires are cold.

Tire pressure of cold tires

The tires are cold:

- if the vehicle has been parked without direct sunlight on the tires for at least three hours and
- if the vehicle has not been driven further than 1 mile (1.6 km)

Tread

The part of the tire that comes into contact with the road.

Bead

The tire bead ensures that the tire sits securely on the wheel. There are several steel wires in the bead to prevent the tire from coming loose from the wheel rim.

Sidewall

The part of the tire between the tread and the bead.

Weight of optional extras

The combined weight of those optional extras that weigh more than the replaced standard part and more than 2.3 kg (5 lbs). These

optional extras, such as high-performance brakes, level control, a roof rack or a high-performance battery, are not included in the curb weight and the weight of the accessories.

TIN (Tire Identification Number)

This is a unique identifier which can be used by a tire manufacturer to identify tires, for example for a product recall, and thus identify the purchasers. The TIN is made up of the manufacturer's identity code, tire size, tire type code and the manufacturing date.

Load bearing index

The load bearing index (also load index) is a code that contains the maximum load bearing capacity of a tire.

Traction

Traction is the result of friction between the tires and the road surface.

Treadwear indicators

Narrow bars (tread wear bars) that are distributed over the tire tread. If the tire tread is level with the bars, the wear limit of $\frac{1}{16}$ in (1.6 mm) has been reached.

Occupant distribution

The distribution of occupants in a vehicle at their designated seating positions.

Total load limit

Nominal load and luggage load plus 68 kilograms (150 lb) multiplied by the number of seats in the vehicle.

Changing a wheel

Flat tire

You can find information on what to do in the event of a flat tire in the "Flat tire" section (▷ page 295). Information on driving with MOExtended tires in the event of a flat tire can be found under "MOExtended tires (tires with run-flat characteristics)" (▷ page 295).

Vehicle with emergency spare wheel: in the event of a flat tire, the emergency spare wheel is mounted as described under "Mounting a wheel" (▷ page 337).

Rotating the wheels

WARNING

Interchanging the front and rear wheels may severely impair the driving characteristics if the wheels or tires have different dimensions. The wheel brakes or suspension components may also be damaged. There is a risk of accident.

Rotate front and rear wheels only if the wheels and tires are of the same dimensions.

! On vehicles equipped with a tire pressure monitor, electronic components are located in the wheel.

Tire-mounting tools should not be used near the valve. This could damage the electronic components.

Only have tires changed at a qualified specialist workshop.

Always pay attention to the instructions and safety notes when changing a wheel (▷ page 336).

The wear patterns on the front and rear tires differ, depending on the operating conditions. Rotate the wheels before a clear wear pattern has formed on the tires. Front tires typically wear more on the shoulders and the rear tires in the center.

If your vehicle's tire configuration allows, you can rotate the wheels according to the

intervals in the tire manufacturer's warranty book in your vehicle documents. If no warranty book is available, the tires should be rotated every 3,000 to 6,000 miles (5,000 to 10,000 km), or earlier if tire wear requires. Do not change the direction of wheel rotation.

Clean the contact surfaces of the wheel and the brake disc thoroughly every time a wheel is rotated. Check the tire pressure and, if necessary, restart the tire pressure loss warning system or the tire pressure monitor.

Direction of rotation

Tires with a specified direction of rotation have additional benefits, e.g. if there is a risk of hydroplaning. You will only gain these benefits if the correct direction of rotation is maintained.

An arrow on the sidewall of the tire indicates its correct direction of rotation.

Storing wheels

Store wheels that are not being used in a cool, dry and preferably dark place. Protect the tires from oil, grease, gasoline and diesel.

Cleaning the wheels

WARNING

The water jet from a circular jet nozzle (dirt blasters) can cause invisible exterior damage to the tires or chassis components.

Components damaged in this way may fail unexpectedly. There is a risk of an accident.

Do not use power washers with circular jet nozzles to clean the vehicle. Have damaged tires or chassis components replaced immediately.

Mounting a wheel

Preparing the vehicle

- ▶ Stop the vehicle on solid, non-slippery and level ground.
- ▶ Apply the electric parking brake manually (▷ page 153).
- ▶ Bring the front wheels into the straight-ahead position.
- ▶ Move the DIRECT SELECT lever to position **P**.
- ▶ Switch off the engine.
- ▶ Remove the SmartKey from the ignition lock.
- ▶ If included in the vehicle equipment, remove the tire-change tool kit from the vehicle.
- ▶ Secure the vehicle to prevent it from rolling away.

Securing the vehicle to prevent it from rolling away

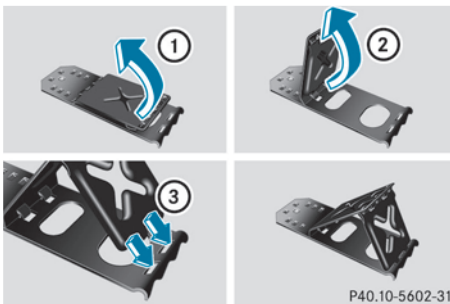

If your vehicle is equipped with a wheel chock, it can be found in the tire-change tool kit (▷ page 294).

The folding wheel chock is an additional safety measure to prevent the vehicle from rolling away, for example when changing a wheel.

- ▶ Fold both plates upwards ①.
- ▶ Fold out lower plate ②.
- ▶ Guide the lugs on the lower plate fully into the openings in base plate ③.



Securing the vehicle on level ground

- ▶ **On level ground:** place chocks or other suitable items under the front and rear of the wheel that is diagonally opposite the wheel you wish to change.

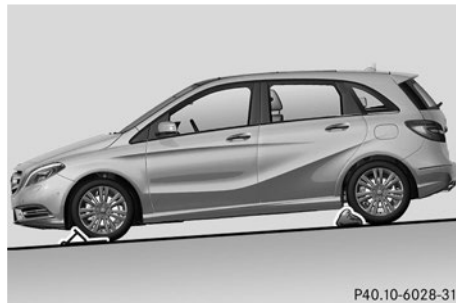

Securing the vehicle on slight downhill gradients

- ▶ **On light downhill gradients:** place chocks or other suitable items in front of the wheels of the front and rear axle.

Raising the vehicle

WARNING

If you do not position the jack correctly at the appropriate jacking point of the vehicle, the jack could tip over with the vehicle raised. There is a risk of injury.

Only position the jack at the appropriate jacking point of the vehicle. The base of the jack must be positioned vertically, directly under the jacking point of the vehicle.

The following must be observed when raising the vehicle:

- to raise the vehicle, only use the vehicle-specific jack that has been tested and approved by Mercedes-Benz. If used incorrectly, the jack could tip over with the vehicle raised.
 - the jack is designed only to raise and hold the vehicle for a short time while a wheel is being changed. It is not suited for performing maintenance work under the vehicle.
 - avoid changing the wheel on uphill and downhill slopes.
 - before raising the vehicle, secure it from rolling away by applying the parking brake and inserting wheel chocks. Never disengage the parking brake while the vehicle is raised.
 - the jack must be placed on a firm, flat and non-slip surface. On a loose surface, a large, load-bearing underlay must be used. On a slippery surface, a non-slip underlay must be used, e.g. rubber mats.
 - do not use wooden blocks or similar objects as a jack underlay. Otherwise, the jack will not be able to achieve its load-bearing capacity due to the restricted height.
 - make sure that the distance between the underside of the tires and the ground does not exceed 1.2 in (3 cm).
 - never place your hands and feet under the raised vehicle.
 - never lie under the raised vehicle.
 - never start the engine when the vehicle is raised.
 - never open or close a door or the trunk lid when the vehicle is raised.
 - make sure that no persons are present in the vehicle when the vehicle is raised.
- !** The jack is designed exclusively for jacking up the vehicle at the jacking points. Otherwise, your vehicle could be damaged.

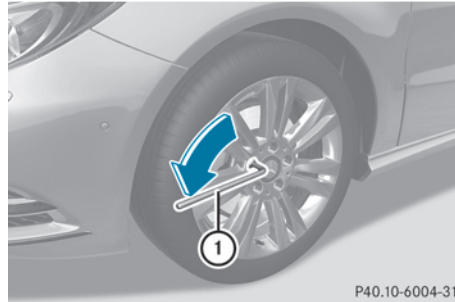

- Using lug wrench ①, loosen the bolts on the wheel you wish to change by about one full turn. Do not unscrew the bolts completely.

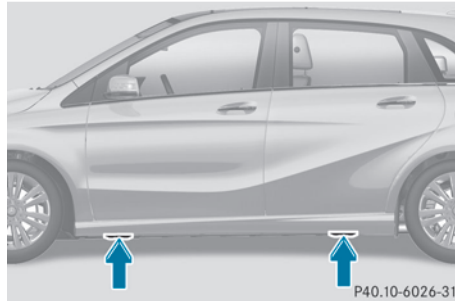

The jacking points are located just behind the wheel housings of the front wheels and just in front of the wheel housings of the rear wheels (arrows).

- Take the ratchet wrench out of the tire-changing tool kit and place it on the hexagon nut of the jack so that the letters **AUF** are visible.

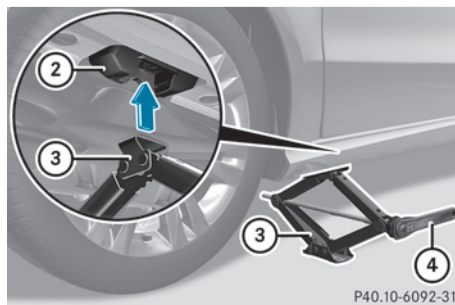

- Position jack ③ at jacking point ②.

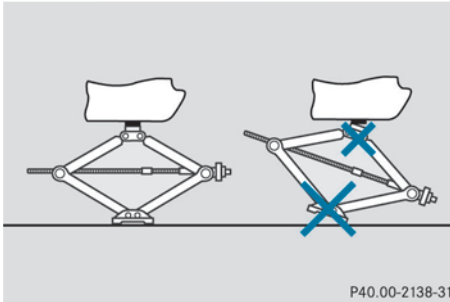

- ▶ Make sure the foot of the jack is directly beneath the jacking point.
- ▶ Turn ratchet wrench ④ until jack ③ sits completely on jacking point ② and the base of the jack lies evenly on the ground.
- ▶ Turn ratchet wrench ④ until the tire is raised a maximum of 1.2 in (3 cm) from the ground.

Removing a wheel

- ❗ Do not place wheel bolts in sand or on a dirty surface. The bolt and wheel hub threads could otherwise be damaged when you screw them in.
- ▶ Unscrew the wheel bolts.
- ▶ Remove the wheel.

Mounting a new wheel

⚠ WARNING

Oiled or greased wheel bolts or damaged wheel bolts/hub threads can cause the wheel bolts to come loose. As a result, you could lose a wheel while driving. There is a risk of accident.

Never oil or grease wheel bolts. In the event of damage to the threads, contact a qualified specialist workshop immediately. Have the damaged wheel bolts or hub threads replaced/renewed. Do not continue driving.

⚠ WARNING

If you tighten the wheel bolts or wheel nuts when the vehicle is raised, the jack could tip over. There is a risk of injury.

Only tighten the wheel bolts or wheel nuts when the vehicle is on the ground.

Always pay attention to the instructions and safety notes in the "Changing a wheel" section (▶ page 336).

Only use wheel bolts that have been designed for the wheel and the vehicle. For safety reasons, Mercedes-Benz recommends that you only use wheel bolts which have been approved for Mercedes-Benz vehicles and the respective wheel.

- ❗ To prevent damage to the paintwork, hold the wheel securely against the wheel hub while screwing in the first wheel bolt.

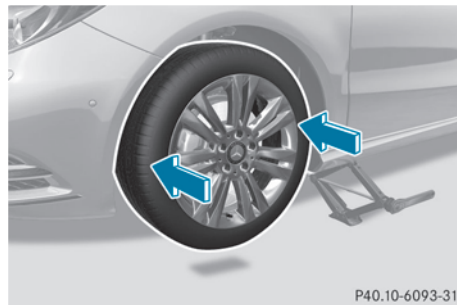

- ▶ Clean the wheel and wheel hub contact surfaces.
- ▶ Place the new wheel on the wheel hub and push it on.
- ▶ Tighten the wheel bolts until they are finger-tight.

Lowering the vehicle

⚠ WARNING

The wheels could work loose if the wheel nuts and bolts are not tightened to the specified tightening torque. There is a risk of accident.

Have the tightening torque immediately checked at a qualified specialist workshop after a wheel is changed.

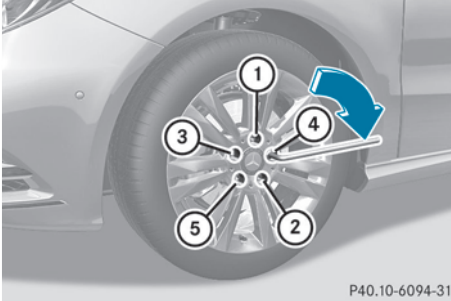

- ▶ Place the ratchet wrench onto the hexagon nut of the jack so that the letters **AB** are visible.
- ▶ Turn the ratchet wrench until the vehicle is once again standing firmly on the ground.
- ▶ Place the jack to one side.
- ▶ Tighten the wheel bolts evenly in a crosswise pattern in the sequence indicated (① to ⑤). The tightening torque must be **96 lb-ft (130 Nm)**.
- ▶ Turn the jack back to its initial position.
- ▶ Stow the jack and the rest of the vehicle tools in the vehicle again.
- ▶ Check the tire pressure of the newly mounted wheel and adjust it if necessary. Observe the recommended tire pressure (▷ page 315).

Wheel and tire combinations

General notes

- ❗ For safety reasons, Mercedes-Benz recommends that you only use tires and wheels which have been approved by Mercedes-Benz specifically for your vehicle.

These tires have been specially adapted for use with the control systems, such as ABS or ESP®, and are marked as follows:

- MO = Mercedes-Benz Original
- MOE = Mercedes-Benz Original Extended (tires featuring run-flat characteristics)
- MO1 = Mercedes-Benz Original (only certain AMG tires)

Mercedes-Benz Original Extended tires may only be used on wheels that have been specifically approved by Mercedes-Benz.

Only use tires, wheels or accessories tested and approved by Mercedes-Benz. Certain characteristics, e.g. handling, vehicle noise emissions or fuel consumption, may otherwise be adversely affected. In addition, when driving with a load, tire dimension variations could cause the tires to come into contact with the bodywork and axle components. This could result in damage to the tires or the vehicle.

Mercedes-Benz accepts no liability for damage resulting from the use of tires, wheels or accessories other than those tested and approved.

Information on tires, wheels and approved combinations can be obtained from any qualified specialist workshop.

- ❗ Retreaded tires are neither tested nor recommended by Mercedes-Benz, since previous damage cannot always be detected on retreaded tires. As a result, Mercedes-Benz cannot guarantee vehicle safety if retreaded tires are mounted. Do not mount used tires if you have no information about their previous usage.

Overview of abbreviations used in the following tire tables:

- BA: both axles
- FA: front axle
- RA: rear axle

The recommended pressures for various operating conditions can be found:

- on the Tire and Loading Information placard with the recommended tire pressures on the B-pillar on the driver's side
- in the tire pressure table on the inside of the fuel filler flap

Observe the notes on recommended tire pressures under various operating conditions (> page 315).

Check tire pressures regularly, and only when the tires are cold. Comply with the maintenance recommendations of the tire manufacturer in the vehicle document wallet.

Notes on the vehicle equipment – always equip the vehicle with:

- tires of the same size on a given axle (left/right)
- the same type of tires at a given time (summer tires, winter tires, MOExtended tires)

Exception: it is permissible to install a different type or make in the event of a flat tire. Observe the "MOExtended tires (tires with run-flat characteristics)" section (> page 295).

Vehicles equipped with MOExtended tires are not equipped with a TIREFIT kit at the factory. It is therefore recommended that you additionally equip your vehicle with a TIREFIT kit if you mount tires that do not feature run-flat properties, e.g. winter tires. A TIREFIT kit may be obtained from a qualified specialist workshop.

- i** The following pages contain information on approved wheel rim and tire sizes for equipping your vehicle with winter tires. Winter tires are not available at the factory as standard equipment or optional extras. If you want to equip your vehicle with approved winter tires, it may be necessary to obtain wheel rims in the corresponding size. The size of the approved winter tires may differ from the standard tires. This is

dependent on the model and the equipment installed at the factory.

The tires and wheel rims, as well as further information, can be obtained at a qualified specialist workshop.

In the following table, the wheel/tire combinations are assigned to the vehicle models through variants, e.g. V1, V2 etc.:

V1	B 250
----	-------

- i** Not all wheel and tire combinations are available at the factory for all countries.

Tires			
	Summer tires	Alloy wheels	V1
BA	225/40 R18 92 W XL ^{5, 6}	7.5 J x 18 H2 Wheel offset: 2.05 in (52 mm)	•
	All-weather tires	Alloy wheels	V1
BA	225/45 R17 91 H M+S ^{5, 6}	7.5 J x 17 H2 Wheel offset: 2.07 in (52.5 mm)	•
	Winter tires	Alloy wheels	V1
BA	205/50 R17 93 H XL M+S  ⁵	6.5 J x 17 H2 Wheel offset: 1.93 in (49 mm)	•

Emergency spare wheel

Important safety notes

WARNING

The wheel or tire size as well as the tire type of the spare wheel or emergency spare wheel and the wheel to be replaced may differ.

Mounting an emergency spare wheel may severely impair the driving characteristics.

There is a risk of an accident.

To avoid hazardous situations:

- adapt your driving style accordingly and drive carefully.
- never mount more than one spare wheel or emergency spare wheel that differs in size.
- only use a spare wheel or emergency spare wheel of a different size briefly.
- do not switch ESP[®] off.
- have a spare wheel or emergency spare wheel of a different size replaced at the nearest qualified specialist workshop. Observe that the wheel and tire dimensions as well as the tire type must be correct.

When using an emergency spare wheel or spare wheel of a different size, you must not exceed the maximum speed of 50 mph (80 km/h).

Snow chains must not be mounted on emergency spare wheels.

General notes

i Apart from some country-specific variants, the vehicles are not equipped with an emergency spare wheel. Emergency spare wheels are specific to the vehicle. For more information on which emergency spare wheels are approved for your vehicle, consult a qualified specialist workshop.

You should regularly check the pressure of the emergency spare wheel, particularly prior to long trips, and correct the pressure as necessary (> page 315). The value on the wheel or as given in the "Wheels and tires" section (> page 343) is valid.

i When you are driving with the collapsible spare wheel mounted, the tire pressure loss warning system or the tire pressure

⁵ Also available as MOExtended tires.

⁶ Use of snow chains is not permitted. Observe the notes in the "Snow chains" section.

monitor cannot function reliably. Only restart the tire pressure loss warning system/the tire pressure monitor when the damaged wheel has been replaced with a new wheel.

Vehicles with tire pressure monitor:

after mounting an emergency spare wheel, the system may still display the tire pressure of the removed wheel for a few minutes. The value displayed for the mounted emergency spare wheel is not the same as the current tire pressure of the emergency spare wheel.

An emergency spare wheel may also be mounted against the direction of rotation. Observe the time restriction on use as well as the speed limitation specified on the emergency spare wheel.

Replace the tires after six years at the latest, regardless of wear. This also applies to the emergency spare wheel.

- ▶ Remove emergency spare wheel bag ① with the "Minispare" emergency spare wheel.
- ▶ Open emergency spare wheel bag ① and remove the "Minispare" emergency spare wheel.

Always observe the instructions and safety notes in the "Mounting a wheel" section (> page 337).

Technical data

"Minispare" emergency spare wheel

Tires

T 125/80 R17 99 M
Tire pressure: 420 kPa
(4.2 bar/61 psi)

Steel wheel

3.5 B x 17 H2
Wheel offset:
0.77 in
(19.5 mm)

Removing the emergency spare wheel

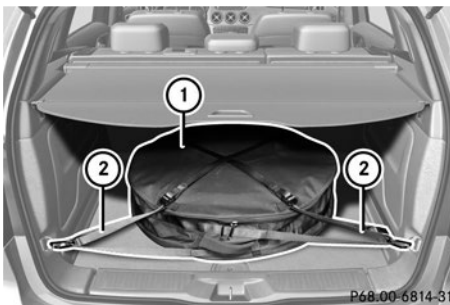

Vehicles with the "Minispare" emergency spare wheel:

The "Minispare" emergency spare wheel is secured in emergency spare wheel bag ① in the trunk.

- ▶ Open the tailgate.
- ▶ Release securing straps ② on emergency spare wheel bag ①.

Useful information	346
Information regarding technical data	346
Warranty	346
Identification plates	346
Service products and filling capacities	347
Vehicle data	353

Useful information

- i** This Operator's Manual describes all models and all standard and optional equipment of your vehicle available at the time of publication of the Operator's Manual. Country-specific differences are possible. Please note that your vehicle may not be equipped with all features described. This also applies to safety-related systems and functions.
- i** Read the information on qualified specialist workshops: (> page 25).

Information regarding technical data

General information

- i** The data stated here specifically refers to a vehicle with standard equipment. Consult an authorized Mercedes-Benz Center for the data for all vehicle variants and trim levels.

Warranty

The Service and Warranty Information booklet contains detailed information about the warranties covering your vehicle.

Your authorized Mercedes-Benz Center will exchange or repair any defective parts originally installed in the vehicle in accordance with the terms of the following warranties:

- New Vehicle Limited Warranty
- Emission System Warranty
- Emission Performance Warranty
- California, Connecticut, Maine, Massachusetts, New York, Pennsylvania, Rhode Island and Vermont Emission Control System Warranty
- State Warranty Enforcement Laws (Lemon Laws)

Replacement parts and accessories are covered by the Mercedes-Benz Parts and Accessories warranties. You can obtain information about this from any authorized Mercedes-Benz Center.

- i** Should you lose your Service and Warranty Information booklet, have an authorized Mercedes-Benz Center arrange for a replacement. It will be mailed to you.

Identification plates

Vehicle identification plate with vehicle identification number (VIN)

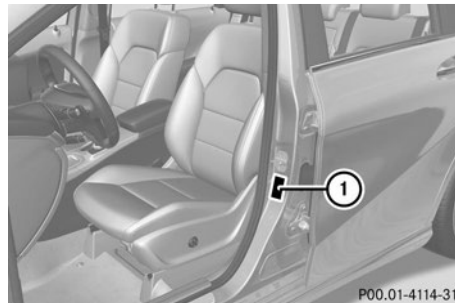

- ▶ Open the driver's door.
You will see vehicle identification plate ①.



Example: vehicle identification plate

- ② VIN
- ③ Paint code

- i** The data shown on the vehicle identification plate is used only as an example. This data is different for every vehicle and can deviate from the data

shown here. You can find the data applicable to your vehicle on the vehicle identification plate.

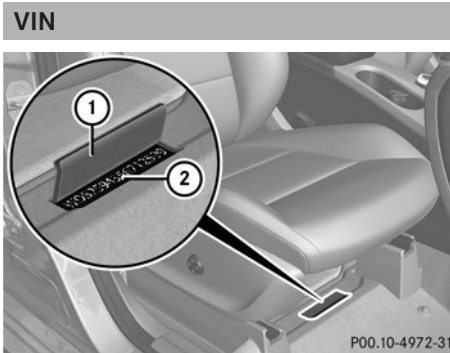

- ▶ Slide the right-hand front seat to its rearmost position.
- ▶ Fold up floor covering ① in front of the right-hand front seat. You will see VIN ②.

The VIN can also be found in the following locations:

- on the lower edge of the windshield (▷ page 347)
- on the vehicle identification plate (▷ page 346)

Engine number

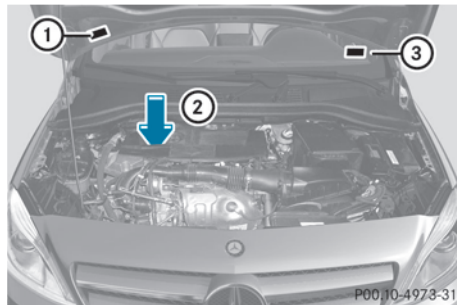

- ① Emissions control information plate
- ② Engine number (stamped into the crankcase)
- ③ VIN (on the lower edge of the windshield)

Service products and filling capacities

Important safety notes

WARNING

Service products may be poisonous and hazardous to health. There is a risk of injury. Comply with instructions on the use, storage and disposal of service products on the labels of the respective original containers. Always store service products sealed in their original containers. Always keep service products out of the reach of children.

Environmental note

Dispose of service products in an environmentally responsible manner.

Service products include the following:

- Fuels
- Lubricants (e.g. engine oil, transmission oil)
- Coolant
- Brake fluid
- Windshield washer fluid
- Climate control system refrigerant

Components and service products must be matched. You should therefore only use

products that have been tested and approved by Mercedes-Benz.

Information about tested and approved products can be obtained from an authorized Mercedes-Benz Center or on the Internet at <http://bevo.mercedes-benz.com>.

You can recognize service products approved by Mercedes-Benz by the following inscription on the containers:

- MB-Freigabe (e.g. MB-Freigabe 229.51)
- MB Approval (e.g. MB Approval 229.51)

Other designations or recommendations indicate a level of quality or a specification in accordance with an MB Sheet number (e.g. MB 229.5). They have not necessarily been approved by Mercedes-Benz.

Fuel

Important safety notes

WARNING

Fuel is highly flammable. If you handle fuel incorrectly, there is a risk of fire and explosion.

You must avoid fire, open flames, creating sparks and smoking. Switch off the engine and, if applicable, the auxiliary heating before refueling.

WARNING

Fuel is poisonous and hazardous to health. There is a risk of injury.

You must make sure that fuel does not come into contact with your skin, eyes or clothing and that it is not swallowed. Do not inhale fuel vapors. Keep fuel away from children.

If you or others come into contact with fuel, observe the following:

- Wash away fuel from skin immediately using soap and water.
- If fuel comes into contact with your eyes, immediately rinse them thoroughly with

clean water. Seek medical assistance without delay.

- If fuel is swallowed, seek medical assistance without delay. Do not induce vomiting.
- Immediately change out of clothing which has come into contact with fuel.

Tank capacity

Model	Total capacity
All models	13.2 US qt (50.0 l)

Model	Of which reserve
All models	Approx. 1.6 US qt (6.0 l)

Gasoline

Fuel grade

 Do not use diesel to refuel vehicles with a gasoline engine. Do not switch on the ignition if you accidentally refuel with the wrong fuel. Otherwise, the fuel will enter the fuel system. Even small amounts of the wrong fuel could result in damage to the fuel system and the engine. Notify a qualified specialist workshop and have the fuel tank and fuel lines drained completely.

 Only refuel using unleaded gasoline with a minimum octane rating of 91.

 Only use the fuel recommended. Operating the vehicle with other fuels can lead to engine failure.

 Do not use the following:

- E85 (gasoline with 85% ethanol)
- E100 (100% ethanol)
- M15 (gasoline with 15% methanol)

- M30 (gasoline with 30% methanol)
- M85 (gasoline with 85% methanol)
- M100 (100% methanol)
- Gasoline with metalliferous additives
- Diesel

Do not mix such fuels with the fuel recommended for your vehicle. Do not use additives. This can otherwise lead to engine damage. This does not include cleaning additives for the removal and prevention of residue build-up. Gasoline may only be mixed with cleaning additives recommended by Mercedes-Benz; see "Additives". You can obtain further information from any authorized Mercedes-Benz Center.

! To ensure the longevity and full performance of the engine, only premium-grade unleaded gasoline must be used.

If standard premium-grade unleaded gasoline is unavailable and unleaded gasoline of a lower grade is used for refueling, observe the following precautions:

- only fill the fuel tank to half full with regular unleaded gasoline and fill the rest with premium-grade unleaded gasoline as soon as possible.
- do not drive at the maximum speed.
- avoid sudden acceleration and engine speeds above 3000 rpm.
- never refuel using fuel with an octane number lower than 87. Otherwise, engine failure could occur.

Using mixtures of methanol and ethanol is not permitted. E10 fuel or E15 fuel (unleaded gasoline with 10% or 15% ethanol) can be used.

You will usually find information about the fuel grade on the pump. If you cannot find the label on the pump, ask the staff for assistance.

i For further information, consult a qualified specialist workshop or on the

Internet at <http://www.mbusa.com> (USA only).

Information on refueling (▷ page 150).

Additives

! Operating the engine with fuel additives added later can lead to engine failure. Do not mix fuel additives with fuel. This does not include additives for the removal and prevention of residue buildup. Gasoline must only be mixed with additives recommended by Mercedes-Benz. Comply with the instructions for use on the product label. More information about recommended additives can be obtained from any authorized Mercedes-Benz Center.

Mercedes-Benz recommends that you use fuel brands that have the additives.

The quality of the fuel available in some countries may not be sufficient. Residue could build up as a result. In such cases, and in consultation with an authorized Mercedes-Benz Center, the gasoline may be mixed with the cleaning additive recommended by Mercedes-Benz (part no. A000989254512). You must observe the notes and mixing ratios specified on the container.

Engine oil

General notes

! Never use engine oil or an oil filter of a specification other than is necessary to fulfill the prescribed service intervals. Do not change the engine oil or oil filter in order to achieve longer replacement intervals than those prescribed. You could otherwise cause engine damage or damage to the exhaust gas aftertreatment.

Follow the instructions in the service interval display regarding the oil change. Otherwise, you may damage the engine and the exhaust gas aftertreatment.

When handling engine oil, observe the important safety notes on service products (▷ page 347).

The engine oils are matched to the performance of Mercedes-Benz engines and service intervals. You should therefore only use engine oils and oil filters that are approved for vehicles with maintenance systems.

For a list of approved engine oils and oil filters, consult an authorized Mercedes-Benz Center. Or visit the website <http://bevo.mercedes-benz.com>.

The table shows which engine oils have been approved for your vehicle.

Model	Engine model	MB Approval
B 250	270	229.5

i MB approval is indicated on the oil containers.

Filling capacities

The following values refer to an oil change including the oil filter.

Model	Capacity
B 250	5.9 US qt (5.6 l)

Additives

! Do not use any additives in the engine oil. This could damage the engine.

Engine oil viscosity

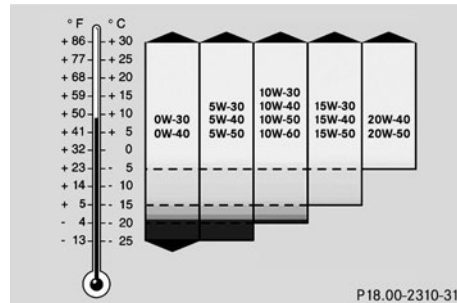

Viscosity describes the flow characteristics of a fluid. If an engine oil has a high viscosity, this means that it is thick; a low viscosity means that it is thin.

Select an engine oil with an SAE classification (viscosity) suitable for the prevailing outside temperatures. The table shows you which SAE classifications are to be used. The low-temperature characteristics of engine oils can deteriorate significantly, e.g. as a result of aging, soot and fuel deposits. It is therefore strongly recommended that you carry out regular oil changes using an approved engine oil with the appropriate SAE classification.

Brake fluid

! WARNING

The brake fluid constantly absorbs moisture from the air. This lowers the boiling point of the brake fluid. If the boiling point of the brake fluid is too low, vapor pockets may form in the brake system when the brakes are applied hard. This would impair braking efficiency. There is a risk of an accident.

You should have the brake fluid renewed at the specified intervals.

When handling brake fluid, observe the important safety notes on service products (▷ page 347).

The brake fluid change intervals can be found in the Maintenance Booklet.

Only use brake fluid approved by Mercedes-Benz according to MB Approval 331.0. Information about approved brake fluid can be obtained at any qualified specialist workshop or on the Internet at <http://bevo.mercedes-benz.com>.

- i** Have the brake fluid renewed regularly at a qualified specialist workshop.

Coolant

Important safety notes

WARNING

If antifreeze comes into contact with hot components in the engine compartment, it may ignite. There is a risk of fire and injury. Let the engine cool down before you add antifreeze. Make sure that antifreeze is not spilled next to the filler neck. Thoroughly clean the antifreeze from components before starting the engine.

- !** Only add coolant that has been premixed with the desired antifreeze protection. You could otherwise damage the engine. Further information on coolants can be found in the Mercedes-Benz Specifications for Service Products, MB Specifications for Service Products 310.1, e.g. on the Internet at <http://bevo.mercedes-benz.com>. Or contact a qualified specialist workshop.
- !** Always use a suitable coolant mixture, even in countries where high temperatures prevail. Otherwise, the engine cooling system is not sufficiently protected from corrosion and overheating.
- i** Have the coolant regularly replaced at a qualified specialist workshop and the replacement confirmed in the Maintenance Booklet.

Comply with the important safety precautions for service products when handling coolant (▷ page 347).

The coolant is a mixture of water and antifreeze/corrosion inhibitor. It performs the following tasks:

- corrosion protection
- antifreeze protection
- raising the boiling point

If the coolant has antifreeze protection down to -35 °F (-37 °C), the boiling point of the coolant during operation is approximately 266 °F (130 °C).

The antifreeze/corrosion inhibitor concentration in the engine cooling system should:

- be at least 50%. This will protect the engine cooling system against freezing down to approximately -35 °F (-37 °C).
- not exceed 55% (antifreeze protection down to -49 °F [-45 °C]). Otherwise, heat will not be dissipated as effectively.

If the vehicle has lost coolant, add equal amounts of water and antifreeze/corrosion inhibitor.

Mercedes-Benz recommends an antifreeze/corrosion inhibitor concentrate in accordance with MB Specifications for Service Products 310.1.

- i** When the vehicle is first delivered, it is filled with a coolant mixture that ensures adequate antifreeze and corrosion protection.
- i** The coolant is checked with every maintenance interval at a qualified specialist workshop.

Filling capacities

Missing values were not available at time of going to print.

Model	Capacity
B 250	Approx. 8.2 US qt (7.8 l)

- i** Use antifreeze/corrosion inhibitor according to MB approval 325.0 or 326.0.

Windshield washer system

Important safety notes

WARNING

Windshield washer concentrate is highly flammable. If it comes into contact with hot engine components or the exhaust system it could ignite. There is a risk of fire and injury.

Make sure that no windshield washer concentrate is spilled next to the filler neck.

- !** Do not add distilled or de-ionized water to the washer fluid container. Otherwise, the level sensor may be damaged.
- !** Only MB SummerFit and MB WinterFit washer fluid should be mixed together. The spray nozzles may otherwise become blocked.

When handling washer fluid, observe the important safety notes on service products (▷ page 347).

At temperatures above freezing:

- ▶ Fill the washer fluid reservoir with a mixture of water and windshield washer fluid, e.g. MB SummerFit.

Add 1 part MB SummerFit to 100 parts water.

At temperatures below freezing:

- ▶ Fill the washer fluid reservoir with a mixture of water and washer fluid, e.g. MB WinterFit.

Adapt the mixing ratio to the outside temperature.

- Down to 14 °F (-10 °C): mix 1 part MB WinterFit to 2 parts water.
- Down to -4 °F (-20 °C): mix 1 part MB WinterFit to 1 part water.
- Down to -20.2 °F (-29 °C): mix 2 parts MB WinterFit to 1 part water.

- i** Add windshield washer fluid, e.g. MB SummerFit or MB WinterFit, to the washer fluid all year round.

Climate control system refrigerant

Important safety notes

The climate control system of your vehicle is filled with refrigerant R-134a.

The instruction label regarding the refrigerant type used can be found on the radiator cross member.

- !** Only the refrigerant R-134a and the PAG oil approved by Mercedes-Benz may be used. The approved PAG oil may not be mixed with any other PAG oil that is not approved for R-134a refrigerant. Otherwise, the climate control system may be damaged.

Service work, such as topping-up refrigerant or replacing components, may only be carried out by a qualified specialist workshop. All applicable regulations must be adhered to, SAE standard J639 included.

Always have work on the climate control system carried out at a qualified specialist workshop.

Refrigerant instruction label

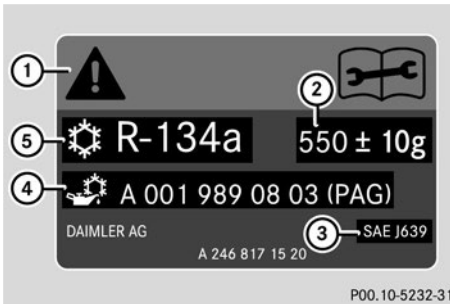

Example: refrigerant instruction label

- ① Warning symbol
- ② Refrigerant filling capacity
- ③ Applicable SAE standards
- ④ PAG oil part number
- ⑤ Type of refrigerant

Warning symbols ① indicate:

- possible dangers
- having service work carried out at a qualified specialist workshop

Filling capacities

Missing values were not available at time of going to print.

All models	Capacity
Refrigerant	
PAG oil	

Vehicle data

General notes

Please note that for the specified vehicle data:

- the heights specified may vary as a result of:
 - tires
 - load
 - condition of the suspension
 - optional equipment
- optional equipment reduces the maximum payload.

Dimensions and weights



Model	① Maximum headroom	② Opening height
B 250	73.8 in (1874 mm)	78.0 in (1981 mm)

B 250	
Vehicle length	171.6 in (4359 mm)
Vehicle width including exterior mirrors	79.1 in (2010 mm)
Vehicle height	61.3 in (1558 mm)

B 250	
Wheelbase	106.3 in (2699 mm)
Turning radius	36.1 ft (11.0 m)
Maximum roof load	165 lb (75.0 kg)

Publication details

Internet

Further information about Mercedes-Benz vehicles and about Daimler AG can be found on the following websites:

<http://www.mercedes-benz.ca>

Editorial office

©Daimler AG: Not to be reprinted, translated or otherwise reproduced, in whole or in part, without written permission from Daimler AG.

Vehicle manufacturer

Daimler AG
Mercedesstraße 137
70327 Stuttgart
Germany



2465842881

Order no. 65151726 13 Part no. 2465842881 Edition A 2014