



B-Class

Operator's Manual



Mercedes-Benz

Symbols

Registered trademarks:

- Bluetooth® is a registered trademark of Bluetooth SIG Inc.
- DTS is a registered trademark of DTS, Inc.
- Dolby and MLP are registered trademarks of DOLBY Laboratories.
- BabySmart™, ESP® and PRE-SAFE® are registered trademarks of Daimler AG.
- HomeLink® is a registered trademark of Prince.
- iPod® and iTunes® are registered trademarks of Apple Inc.
- Logic7® is a registered trademark of Harman International Industries.
- Microsoft® and Windows media® are registered trademarks of Microsoft Corporation.
- SIRIUS is a registered trademark of Sirius XM radio Inc.
- HD Radio is a registered trademark of iBiquity Digital Corporation.
- Gracenote® is a registered trademark of Gracenote, Inc.
- ZAGATSurvey® and related brands are registered trademarks of ZagatSurvey, LLC.

In this Operator's Manual, you will find the following symbols:

WARNING

Warning notes draw your attention to hazards that endanger your health or life, or the health or life of others.

Environmental note

Environmental notes provide you with information on environmentally aware actions or disposal.

- ! Notes on material damage alert you to dangers that could lead to damage to your vehicle.

- i Practical tips or further information that could be helpful to you.

- ▶ This symbol indicates an instruction that must be followed.
- ▶ Several of these symbols in succession indicate an instruction with several steps.
- (▷ page) This symbol tells you where you can find more information about a topic.
- ▷▷ This symbol indicates a warning or an instruction that is continued on the next page.

Display This font indicates a display in the multifunction display/COMAND display.

Parts of the software in the vehicle are protected by copyright © 2005 The FreeType Project <http://www.freetype.org>. All rights reserved.

Publication details

Internet

Further information about Mercedes-Benz vehicles and about Daimler AG can be found on the following websites

<http://www.mercedes-benz.ca>

Editorial office

You are welcome to forward any queries or suggestions you may have regarding this Operator's Manual to the technical documentation team at the following address:

Daimler AG, HPC: CAC, Customer Service,
70546 Stuttgart, Germany

©Daimler AG: Not to be reprinted, translated or otherwise reproduced, in whole or in part, without written permission of Daimler AG.

Welcome to the world of Mercedes-Benz

Before you first drive off, read this Operator's Manual carefully and familiarize yourself with your vehicle. For your own safety and a longer vehicle life, follow the instructions and warning notices in this manual. Disregarding them may lead to damage to the vehicle or personal injury.

Vehicle damage resulting from the disregard of the instructions is not covered by the Mercedes-Benz Limited Warranty.

The equipment or model designation of your vehicle may differ according to:

- model
- order
- country variant
- availability

Mercedes-Benz therefore reserves the right to introduce changes in the following areas:

- design
- equipment
- technical features

Therefore, descriptions may vary from those of your own vehicle.

The following are integral components of the vehicle:

- Operator's Manual
- Maintenance Booklet
- Equipment-dependent supplements

Keep printed copies of the documents in the vehicle at all times. If you sell the vehicle, always pass the documents on to the new owner.

The technical documentation team at Daimler AG wishes you safe and pleasant motoring.

Mercedes-Benz USA, LLC

Mercedes-Benz Canada, Inc.

A Daimler Company

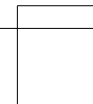
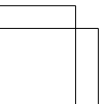
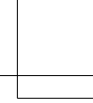
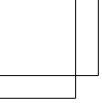

Index	4	At a glance	25
Introduction	20	Safety	35
		Opening/closing	67
		Seats, steering wheel and mirrors	83
		Lights and windshield wipers	95
		Climate control	113
		Driving and parking	125
		On-board computer and displays	177
		Stowage and features	229
		Maintenance and care	259
		Breakdown assistance	273
		Wheels and tires	291
		Technical data	321

1, 2, 3 ...

12 V socket

see Sockets

A**ABS (Anti-lock Braking System)**

Display message	194
Function/notes	59
Important safety notes	59
Warning lamp	220

Activating/deactivating cooling**with air dehumidification** 118**Active Parking Assist**

Display message	211
Function/notes	165
Important safety notes	164

Active Service System

see ASSYST PLUS

ADAPTIVE BRAKE 64**Adaptive Brake Assist**

Display message	201
Function/notes	61

Adaptive brake lamps 63**Adaptive Highbeam Assist**

Display message	206
Function/notes	100
Switching on/off (on-board computer)	190

Additional speedometer 189**Additives (engine oil)** 327**Air bags**

Deployment	37
Front air bag (driver, front passenger)	41
Important safety notes	39
Knee bag	42
Safety guidelines	38
Side impact air bag	42
Window curtain air bag	42

Air-conditioning system

see Climate control

Air vents

Important safety notes	123
Rear	124
Setting	123

Setting the center air vents 123

Setting the side air vents 124

Alarm system

see ATA (Anti-Theft Alarm system)

Anti-lock braking system

see ABS (Anti-lock Braking System)

Anti-theft alarm system

see ATA (Anti-Theft Alarm system)

Anti-theft system

Interior motion sensor 66

Ashtray 242**Assistance menu (on-board****computer)** 187**ASSYST PLUS**

Displaying a service message	264
Hiding a service message	264
Notes	264
Resetting the service interval display	264
Service message	264
Special service requirements	265

ATA (Anti-Theft Alarm system)

Activating/deactivating	65
Function	65
Switching off the alarm	65

ATTENTION ASSIST

Activating/deactivating	188
Display message	209
Function/notes	171

Audio menu (on-board computer) 185**Audio system**

see separate operating instructions

Authorized Centers

see Qualified specialist workshop

Authorized Mercedes-Benz Center

see Qualified specialist workshop

Authorized workshops

see Qualified specialist workshop

AUTO lights

Display message	205
see Lights	

**Automatic engine start (ECO start/
stop function)** 129**Automatic engine switch-off (ECO
start/stop function)** 129**Automatic headlamp mode** 97

- Automatic transmission**
- Automatic drive program 136
 - Changing gear 135
 - DIRECT SELECT lever 133
 - Display message 215
 - Drive program display 133
 - Driving tips 135
 - Emergency running mode 139
 - Engaging drive position 134
 - Engaging neutral 134
 - Engaging reverse gear 134
 - Engaging the park position 133
 - Kickdown 135
 - Manual drive program 136
 - Overview 132
 - Problem (malfunction) 139
 - Program selector button 135
 - Pulling away 127
 - Starting the engine 127
 - Steering wheel paddle shifters 136
 - Transmission position display 133
 - Transmission positions 134
- Automatic transmission emergency mode** 139
- B**
- Backup lamp**
- Changing bulbs 107
 - Display message 205
- Bag hook** 237
- BAS (Brake Assist System)** 60
- Battery (SmartKey)**
- Checking 70
 - Important safety notes 70
 - Replacing 70
- Battery (vehicle)**
- Charging 281
 - Display message 208
 - Important safety notes 279
 - Jump starting 283
- Belt force limiters (activation)** 37
- Blinds**
- see Roller sunblind
- Blind Spot Assist**
- Activating/deactivating 188
 - Notes/function 173
- Brake Assist**
- see BAS (Brake Assist System)
- Brake fluid**
- Display message 200
 - Notes 327
- Brake lamps**
- Adaptive 63
 - Changing bulbs 107
 - Display message 203
- Brakes**
- ABS 59
 - Adaptive Brake Assist 61
 - BAS 60
 - Brake fluid (notes) 327
 - Display message 194
 - Driving tips 146
 - Important safety notes 146
 - Maintenance 147
 - Parking brake 142
 - Warning lamp 220
- Breakdown**
- see Flat tire
 - see Towing away/tow-starting
- Bulbs**
- see Changing bulbs
- C**
- Calling up a malfunction**
- see Display messages
- Car**
- see Vehicle
- Care**
- Carpets 271
 - Car wash 265
 - Display 269
 - Exhaust pipe 269
 - Exterior lights 268
 - Gear or selector lever 270
 - Interior 269
 - Matte finish 267
 - Notes 265
 - Paint 267
 - Plastic trim 269
 - Power washer 266
 - Rear view camera 269
 - Roof lining 271
 - Seat belt 271

- Seat cover 270
- Sensors 269
- Steering wheel 270
- Trim pieces 270
- Washing by hand 266
- Wheels 267
- Windows 268
- Wiper blades 268
- Wooden trim 270
- Cargo compartment cover** 237
- Cargo compartment enlargement** ... 234
 - Important safety notes 234
 - Notes on use 236
- Cargo compartment floor**
 - Height adjustment 240
 - Opening/closing 239
 - Stowage well (under) 239
- Cargo net**
 - Attaching 239
 - Important safety information 238
- Cargo tie down rings** 237
- Car wash (care)** 265
- Center console**
 - Lower section 31
 - Upper section 30
- Central locking**
 - Automatic locking (on-board computer) 191
 - Locking/unlocking (SmartKey) 68
- Changing bulbs**
 - Brake lamps 107
 - Cornering light function 106
 - High-beam headlamps 105
 - Important safety notes 102
 - License plate lighting 109
 - Low-beam headlamps 105
 - Overview of bulb types 103
 - Parking lamps 105
 - Rear fog lamp 107
 - Removing/replacing the cover (front wheel arch) 104
 - Reversing lamps 107
 - Standing lamps (front) 105
 - Tail lamps 107
 - Turn signals (front) 106
 - Turn signals (rear) 107
- Child-proof locks**
 - Important safety notes 58
 - Rear doors 58
- Children**
 - In the vehicle 47
 - Restraint systems 47
- Child seat**
 - Automatic recognition 50
 - LATCH-type (ISOFIX) child seat anchors 51
 - On the front-passenger seat 49
 - Problem (malfunction) 54
 - Recommendations 56
 - Suitable positions 54
 - Top Tether 52
- Cigarette lighter** 243
- Climate control**
 - Automatic climate control (dual-zone) 117
 - Controlling automatically 119
 - Cooling with air dehumidification . . 118
 - Defrosting the windows 121
 - Defrosting the windshield 121
 - Dual-zone automatic climate control 115
 - Important safety notes 114
 - Indicator lamp 119
 - Notes on using automatic climate control 115, 117
 - Overview of systems 114
 - Problems with cooling with air dehumidification 119
 - Problem with the rear window defroster 122
 - Setting the air distribution 120
 - Setting the airflow 120
 - Setting the air vents 123
 - Setting the temperature 119
 - Switching air-recirculation mode on/off 122
 - Switching on/off 118
 - Switching residual heat on/off 122
 - Switching the rear window defroster on/off 122
 - Switching the ZONE function on/off 120

- Cockpit**
 Overview 26
 see Instrument cluster
- COLLISION PREVENTION ASSIST** 60
- COMAND**
 see separate operating instructions
- Combination switch** 98
- Compass**
 Calibrating 257
 Calling up 257
 Setting 257
- Consumption statistics (on-board computer)** 182
- Convenience closing feature** 78
- Convenience opening feature** 78
- Coolant (engine)**
 Checking the level 263
 Display message 206
 Filling capacity 328
 Important safety notes 327
 Temperature gauge 179
 Warning lamp 226
- Cooling**
 see Climate control
- Cornering light function**
 Changing bulbs 106
 Display message 203
 Function/notes 99
- Crash-responsive emergency lighting** 102
- Cruise control**
 Activation conditions 150
 Cruise control lever 150
 Deactivating 151
 Display message 213
 Driving system 150
 Function/notes 150
 Important safety notes 150
 Setting a speed 151
 Storing and maintaining current speed 151
- Cup holder**
 Center console 241
 Important safety notes 241
 Rear compartment 242
- Customer Assistance Center (CAC)** ... 24
- Customer Relations Department** 24
- D**
- Dashboard**
 see Instrument cluster
- Dashboard lighting**
 see Instrument cluster lighting
- Data**
 see Technical data
- Daytime running lamps**
 Display message 205
 Switching on/off (on-board computer) 190
 Switching on/off (switch) 97
- Dealerships**
 see Qualified specialist workshop
- Delayed switch-off**
 Exterior lighting (on-board computer) 190
 Interior lighting 191
- Diagnostics connection** 23
- Digital speedometer** 183
- DIRECT SELECT lever**
 see Automatic transmission
- Display (cleaning instructions)** 269
- Display messages**
 ASSYST PLUS 264
 Calling up (on-board computer) 193
 Driving systems 209
 Engine 206
 General notes 193
 Hiding (on-board computer) 193
 Lights 202
 Safety systems 194
 SmartKey 218
 Tires 214
 Vehicle 215
- Distance display (on-board computer)** 187
- Distance recorder** 182
 see Trip odometer
- Distance warning function**
 Activating/deactivating 188
 Function/notes 60
 Warning lamp 228
- DISTRONIC PLUS**
 Activation conditions 154
 Cruise control lever 154
 Deactivating 157

- Display message 211
- Displays in the multifunction display 155
- Driving tips 158
- Function/notes 153
- Important safety notes 152
- Setting the specified minimum distance 157
- Warning lamp 228
- Doors**
 - Automatic locking (on-board computer) 191
 - Automatic locking (switch) 74
 - Central locking/unlocking (SmartKey) 68
 - Control panel 33
 - Display message 217
 - Emergency locking 75
 - Emergency unlocking 75
 - Important safety notes 73
 - Opening (from inside) 74
- Drinking and driving** 144
- Drinks holder**
 - see Cup holder
- Drive program**
 - Automatic 136
 - Display (DIRECT SELECT lever) 133
 - Manual 136
- Driver's door**
 - see Doors
- Driving abroad**
 - Mercedes-Benz Service 265
 - Symmetrical low beam 96
- Driving lamps**
 - see Daytime running lamps
- Driving on flooded roads** 149
- Driving safety systems**
 - ABS (Anti-lock Braking System) 59
 - ADAPTIVE BRAKE 64
 - Adaptive Brake Assist 61
 - Adaptive brake lamps 63
 - BAS (Brake Assist System) 60
 - COLLISION PREVENTION ASSIST 60
 - Distance warning function 60
 - Electronic brake force distribution ... 64
 - ESP® (Electronic Stability Program) 63
 - ETS (Electronic Traction System) 63
 - Important safety information 59
 - Overview 59
 - STEER CONTROL 64
- Driving systems**
 - Active Parking Assist 164
 - ATTENTION ASSIST 171
 - Blind Spot Assist 173
 - Cruise control 150
 - Display message 209
 - DISTRONIC PLUS 152
 - HOLD function 160
 - Lane Keeping Assist 174
 - Lane Tracking package 173
 - PARKTRONIC 161
 - Rear view camera 168
- Driving tips**
 - Automatic transmission 135
 - Brakes 146
 - Break-in period 126
 - Checking brake lining thickness 148
 - DISTRONIC PLUS 158
 - Downhill gradient 146
 - Drinking and driving 144
 - Driving abroad 96
 - Driving in winter 149
 - Driving on flooded roads 149
 - Driving on wet roads 149
 - Exhaust check 145
 - Fuel 144
 - General 144
 - Hydroplaning 149
 - Icy road surfaces 149
 - Limited braking efficiency on salted roads 147
 - Snow chains 295
 - Symmetrical low beam 96
 - Wet road surface 147
- DVD audio (on-board computer)** 185
- DVD video (on-board computer)** 186

E

EASY-VARIO-PLUS system

Cargo compartment enlargement .. 234

EBD (electronic brake force distribution)

Display message 196

Function/notes 64

ECO display

Function/notes 145

On-board computer 183

ECO start/stop function

Deactivating/activating 130

General information 128

Important safety notes 128

Electronic Stability Program

see ESP® (Electronic Stability Program)

Emergency release

Driver's door 75

Vehicle 75

Emergency spare wheel

General notes 318

Important safety notes 318

Removing 319

Technical data 319

Emergency tensioning device

Activation 37

Emergency Tensioning Devices

Function 47

Safety guidelines 38

Emergency unlocking

Tailgate 77

Emissions control

Service and warranty information 21

Engine

Check Engine warning lamp 226

Display message 206

ECO start/stop function 128

Engine number 324

Irregular running 131

Jump-starting 283

Starting problems 131

Starting the engine with the

SmartKey 127

Switching off 142

Tow-starting (vehicle) 287

Engine electronics

Problem (malfunction) 131

Engine jump starting

see Jump starting (engine)

Engine oil

Adding 262

Additives 327

Checking the oil level 261

Checking the oil level using the

dipstick 262

Display message 208

Filling capacity 327

Notes about oil grades 326

Notes on oil level/consumption 261

Viscosity 327

ESP® (Electronic Stability Program)

Deactivating/activating 187

Deactivating/activating (notes) 64

Display message 194

ETS 63

Function/notes 63

Important safety information 63

Warning lamp 222

ETS (Electronic Traction System) 63**Exhaust check 145****Exhaust pipe (cleaning instructions) 269****Exterior lighting**

Setting options 96

see Lights

Exterior mirrors

Adjusting 90

Dipping (automatic) 91

Folding in/out (automatically) 91

Folding in/out (electrically) 91

Folding in when locking (on-board

computer) 192

Out of position (troubleshooting) 91

Setting 91

Storing settings (memory

function) 93

Storing the parking position 92

Eyeglasses compartment 231

F

Filler cap

see Fuel filler flap

First-aid kit 274

- Flat tire**
 MOExtended tires 275
 Preparing the vehicle 275
 TIREFIT kit 276
 see Emergency spare wheel
- Floormat** 258
- Fog lamps**
 Extended range 100
 Switching on/off 97
- Folding table** 232
- Front fog lamps**
 Display message 204
 Switching on/off 97
- Front-passenger seat**
 Folding the backrest forward/
 back 233
- Fuel**
 Additives 326
 Consumption statistics 182
 Displaying the current
 consumption 183
 Displaying the range 183
 Driving tips 144
 Fuel gauge 27
 Grade (gasoline) 325
 Important safety notes 324
 Premium-grade unleaded gasoline . 325
 Problem (malfunction) 141
 Refueling 139
 Tank content/reserve fuel 325
- Fuel filler flap**
 Opening/closing 140
- Fuel level**
 Calling up the range (on-board
 computer) 183
- Fuel tank**
 Capacity 325
 Problem (malfunction) 141
- Fuses**
 Allocation chart 288
 Before changing 288
 Fuse box in the engine
 compartment 288
 Fuse box in the front-passenger
 footwell 288
 Important safety notes 287
- G**
- Garage door opener**
 Clearing the memory 256
 Important safety notes 253
 Opening/closing the garage door .. 256
 Programming (button in the rear-
 view mirror) 254
- Gear or selector lever (cleaning
 guidelines)** 270
- Genuine Mercedes-Benz parts** 322
- Glove box** 231
- H**
- Handbrake**
 see Parking brake
- Hazard warning lamps** 99
- Headlamps**
 Adding fluid to cleaning system 263
 Cleaning system (capacity) 329
 Cleaning system (function) 99
 Cleaning system (notes) 328
 Fogging up 101
 see Automatic headlamp mode
- Head restraints**
 Adjusting 87
 Adjusting (electrically) 87
 Adjusting (manually) 87
 Adjusting (rear) 87
 Installing/removing (rear) 88
- Heating**
 see Climate control
- High-beam headlamps**
 Changing bulbs 105
 Display message 204
 Switching Adaptive Highbeam
 Assist on/off 100
 Switching on/off 98
- Hill start assist** 128
- HOLD function**
 Deactivating 161
 Display message 209
 Function/notes 160
- Hood**
 Closing 261
 Display message 217
 Opening 260

- Hydroplaning** 149
- I**
- Ignition lock**
see Key positions
- Immobilizer** 65
- Indicator lamps**
see Warning and indicator lamps
- Instrument cluster**
Overview 27
Settings 189
Warning and indicator lamps 28
- Instrument cluster lighting** 178
- Interior lighting** 101
Automatic control 102
Delayed switch-off (on-board computer) 191
Emergency lighting 102
Manual control 102
Overview 101
Reading lamp 101
- Interior motion sensor** 66
- J**
- Jack**
Storage location 274
Using 313
- Jump starting (engine)** 283
- K**
- Kickdown**
Driving tips 135
Manual drive program 137
- Knee bag** 42
- L**
- Lamps**
see Warning and indicator lamps
- Lane Keeping Assist**
Activating/deactivating 188
Display message 210
Function/information 174
- Lane Tracking package** 173
- LATCH-type (ISOFIX) child seat anchors** 51
- License plate lamp**
Changing bulbs 109
- License plate lamp (display message)** 204
- Light function, active**
Display message 205
- Lights**
Activating/deactivating the interior lighting delayed switch-off . 191
Automatic headlamp mode 97
Cornering light function 99
Display message 202
Driving abroad 96
Fog lamps 97
Fog lamps (extended) 100
Hazard warning lamps 99
High beam flasher 99
High-beam headlamps 98
Light switch 96
Low-beam headlamps 97
Parking lamps 98
Rear fog lamp 98
Standing lamps 98
Switching Adaptive Highbeam Assist on/off 190
Switching the daytime running lamps on/off (on-board computer) 190
Switching the daytime running lamps on/off (switch) 97
Switching the exterior lighting delayed switch-off on/off (on-board computer) 190
Switching the surround lighting on/off (on-board computer) 190
Turn signals 98
see Changing bulbs
see Interior lighting
- Light sensor (display message)** 205
- Loading guidelines** 230
- Locking**
see Central locking
- Locking (doors)**
Automatic 74
Emergency locking 75
From inside (central locking button) 74

- Locking centrally**
 - see Central locking
 - Locking verification signal (on-board computer)** 191
 - Low-beam headlamps**
 - Changing bulbs 105
 - Display message 203
 - Setting for driving abroad (symmetrical) 96
 - Switching on/off 97
 - Lumbar support**
 - Adjusting the 4-way lumbar support 88
- M**
- M+S tires** 294
 - Malfunction message**
 - see Display messages
 - Matte finish (cleaning instructions)** 267
 - mbrace**
 - Call priority 249
 - Display message 200
 - Downloading destinations (COMAND) 249
 - Downloading routes 252
 - Emergency call 246
 - Geo fencing 253
 - Important safety notes 245
 - Locating a stolen vehicle 251
 - MB info call button 248
 - Remote vehicle locking 251
 - Roadside Assistance button 247
 - Search & Send 250
 - Self-test 246
 - Speed alert 253
 - System 245
 - Triggering the vehicle alarm 253
 - Vehicle remote malfunction diagnosis 251
 - Vehicle remote unlocking 250
 - Mechanical key**
 - Function/notes 69
 - Locking vehicle 75
 - Unlocking the driver's door 75
 - Memory card (audio)** 185
 - Memory function** 93
 - Message memory (on-board computer)** 193
 - Messages**
 - see Display messages
 - Mirrors**
 - see Exterior mirrors
 - see Rear-view mirror
 - see Vanity mirror (in the sun visor)
 - Mobile phone**
 - Menu (on-board computer) 186
 - Modifying the programming (SmartKey)** 69
 - MOExtended tires** 275
 - Mounting wheels**
 - Lowering the vehicle 315
 - Mounting a new wheel 315
 - Preparing the vehicle 312
 - Raising the vehicle 313
 - Removing a wheel 315
 - Securing the vehicle against rolling away 313
 - MP3**
 - Operation 185
 - see separate operating instructions
 - Multifunction display**
 - Function/notes 181
 - Permanent display 190
 - Multifunction steering wheel**
 - Operating the on-board computer . 180
 - Overview 29
- N**
- Navigation**
 - Menu (on-board computer) 184
 - see separate operating instructions
 - Notes on breaking-in a new vehicle** 126
- O**
- Occupant safety**
 - Children in the vehicle 47
 - Important safety notes 36
 - Odometer**
 - see Trip odometer
 - Oil**
 - see Engine oil

- On-board computer**
- Assistance menu 187
 - Audio menu 185
 - Convenience submenu 192
 - Displaying a service message 264
 - Display messages 193
 - Factory settings submenu 192
 - Important safety notes 178
 - Lighting submenu 190
 - Menu overview 182
 - Message memory 193
 - Navigation menu 184
 - Operation 180
 - Service menu 189
 - Settings menu 189
 - Standard display 182
 - Telephone menu 186
 - Trip menu 182
 - Vehicle submenu 191
 - Video DVD operation 186
- Opening and closing the side trim panels** 106
- Operating system**
see On-board computer
- Outside temperature display** 179
- Overhead control panel** 32
- Override feature**
Rear side windows 58
- P**
- Paint code number** 323
- Paintwork (cleaning instructions)** ... 267
- Panic alarm** 36
- Panorama roof with power tilt/sliding panel**
- Opening/closing the roller sunblind 81
 - Problem (malfunction) 82
 - Resetting 81
- Panorama sliding sunroof**
Important safety notes 80
- Parcel net** 233
- Parking** 141
- Important safety notes 141
 - Parking brake 142
 - Position of exterior mirror, front-passenger side 92
 - Rear view camera 168
 - see PARKTRONIC
- Parking aid**
- Active Parking Assist 164
 - see Exterior mirrors
 - see PARKTRONIC
- Parking brake**
- Display message 197
 - Electric parking brake 142
 - Warning lamp 225
- Parking lamps**
Switching on/off 98
- Parking lamps (changing bulbs)** 105
- PARKTRONIC**
- Deactivating/activating 163
 - Driving system 161
 - Function/notes 161
 - Important safety notes 161
 - Problem (malfunction) 164
 - Range of the sensors 162
 - Warning display 162
- PASSENGER AIRBAG OFF indicator lamp** 50
- Plastic trim (cleaning instructions)** . 269
- Power washers** 266
- Power windows**
see Side windows
- Product information** 20
- Program selector button** 135
- Protection of the environment**
General notes 20
- Pulling away**
Automatic transmission 127
- Q**
- Qualified specialist workshop** 23
- R**
- Radar sensor system**
- Activating/deactivating 192
 - Display message 209
- Radio**
Selecting a station 185
- see separate operating instructions

- Reading lamp** 101
- Rear compartment**
 Setting the air vents 124
- Rear fog lamp**
 Changing bulbs 107
 Display message 204
 Switching on/off 98
- Rear lamps**
 Changing bulbs 107
- Rear seat**
 Adjusting the angle of the
 backrests 236
 Folding the backrest forwards/
 back (vehicles without the EASY-
 VARIO-PLUS system) 234
 Folding the backrest forwards/
 back (vehicles with the EASY-
 VARIO-PLUS system) 235
 Fore-and-aft adjustment 237
- Rear view camera**
 Cleaning instructions 269
 Function/notes 168
 Switching on/off 169
- Rear-view mirror**
 Anti-glare (manual) 90
 Dipping (automatic) 91
- Rear window defroster**
 Problem (malfunction) 122
 Switching on/off 122
- Rear window wiper**
 Replacing the wiper blade 111
 Switching on/off 110
- Refueling**
 Fuel gauge 27
 Important safety notes 139
 Refueling process 140
 see Fuel
- Remote control**
 Garage door opener 253
 Programming (garage door
 opener) 254
- Reserve (fuel tank)**
 see Fuel
- Reserve fuel**
 Display message 208
 Warning lamp 226
 see Fuel
- Residual heat (climate control)** 122
- Restraint system**
 see SRS (Supplemental Restraint
 System)
- Roadside Assistance (breakdown)** 21
- Roller sunblind**
 Opening/closing 81
 Panorama roof with power tilt/
 sliding panel 81
- Roof carrier** 240
- Roof lining and carpets (cleaning
 guidelines)** 271
- Roof load (maximum)** 329
- Route (navigation)**
 see Route guidance (navigation)
- Route guidance (navigation)** 184

S

- Safety**
 Children in the vehicle 47
 Child restraint systems 47
- Safety systems**
 see Driving safety systems
- Seat**
 Folding the backrest (rear
 compartment) forwards/back
 (vehicles without the EASY-
 VARIO-PLUS system) 234
 Folding the backrest (rear
 compartment) forwards/back
 (vehicles with the EASY-VARIO-
 PLUS system) 235
- Seat belts**
 Adjusting the height 45
 Belt force limiters 47
 Cleaning 271
 Correct usage 44
 Emergency Tensioning Devices 47
 Fastening 45
 Important safety guidelines 43
 Releasing 46
 Safety guidelines 38
 Warning lamp 218
 Warning lamp (function) 46
- Seats**
 Adjusting (electrically) 87
 Adjusting (manually) 86

- Adjusting the 4-way lumbar support 88
- Adjusting the head restraint 87
- Cleaning the cover 270
- Correct driver's seat position 84
- Important safety notes 85
- Seat heating problem 89
- Storing settings (memory function) 93
- Switching seat heating on/off 89
- Sensors (cleaning instructions)** 269
- Service**
see ASSYST PLUS
- Service menu (on-board computer)** . 189
- Service products**
 - Brake fluid 327
 - Coolant (engine) 327
 - Engine oil 326
 - Fuel 324
 - Important safety notes 324
 - Washer fluid 328
- Service work**
see ASSYST PLUS
- Settings**
 - Factory (on-board computer) 192
 - On-board computer 189
- Setting the air distribution** 120
- Setting the airflow** 120
- Side impact air bag** 42
- Side marker lamp (display message)** 205
- Side windows**
 - Cleaning 268
 - Convenience closing feature 78
 - Convenience opening feature 78
 - Important safety information 77
 - Opening/closing 78
 - Problem (malfunction) 79
 - Resetting 79
- Sliding sunroof**
see Panorama roof with power tilt/sliding panel
- SmartKey**
 - Changing the battery 70
 - Changing the programming 69
 - Checking the battery 70
 - Convenience closing feature 78
 - Convenience opening feature 78
 - Display message 218
 - Door central locking/unlocking 68
 - Important safety notes 68
 - Loss 72
 - Mechanical key 69
 - Positions (ignition lock) 127
 - Problem (malfunction) 72
 - Starting the engine 127
 - SmartKey positions (ignition lock)** .. 127
 - Snow chains** 295
 - Sockets**
 - Center console 244
 - Luggage compartment 245
 - Points to observe before use 244
 - Rear compartment 245
 - Specialist workshop** 23
 - Speed, controlling**
see Cruise control
 - Speedometer**
 - Activating/deactivating the additional speedometer 189
 - Digital 183
 - In the Instrument cluster 27
 - Segments 179
 - Selecting the unit of measurement 189
 - see Instrument cluster
 - SRS (Supplemental Restraint System)**
 - Display message 201
 - Introduction 37
 - Warning lamp 225
 - Warning lamp (function) 37
 - Standing lamps**
 - Changing bulbs 105
 - Display message 204
 - Switching on/off 98
 - Starting (engine)** 127
 - STEER CONTROL** 64
 - Steering (display message)** 217
 - Steering wheel**
 - Adjusting (manually) 89
 - Button overview 29
 - Buttons (on-board computer) 180
 - Cleaning 270
 - Important safety notes 89
 - Paddle shifters 136
 - Steering wheel paddle shifters** 136

- Stowage areas** 230
 - Stowage compartments**
 - Armrest (front) 231
 - Armrest (under) 232
 - Center console 231
 - Cup holders 241
 - Eyeglasses compartment 231
 - Glove box 231
 - Important safety information 230
 - Parcel net 233
 - Under driver's seat/front-passenger seat 232
 - Stowage space**
 - Center console (rear) 232
 - Summer tires** 294
 - Sun visor** 242
 - Supplement Restraint System**
 - see SRS (Supplemental Restraint System)
 - Surround lighting (on-board computer)** 190
 - Switching air-recirculation mode on/off** 122
 - Switching off the alarm (ATA)** 65
- T**
- Tachometer** 179
 - Tailgate**
 - Display message 217
 - Emergency unlocking 77
 - Important safety notes 76
 - Opening/closing (from outside) 76
 - Opening dimensions 329
 - Tail lamps**
 - Display message 204
 - Tank content**
 - Fuel gauge 27
 - Technical data**
 - Capacities 324
 - Emergency spare wheel 319
 - Information 322
 - Tires/wheels 316
 - Vehicle data 329
 - TELEAID**
 - Call priority 249
 - Downloading destinations (COMAND) 249
 - Downloading routes 252
 - Emergency call 246
 - Geo fencing 253
 - Important safety notes 245
 - Locating a stolen vehicle 251
 - MB info call button 248
 - Remote vehicle locking 251
 - Roadside Assistance button 247
 - Search & Send 250
 - Self-test 246
 - Speed alert 253
 - System 245
 - Triggering the vehicle alarm 253
 - Vehicle remote malfunction diagnosis 251
 - Vehicle remote unlocking 250
 - Telephone**
 - Accepting a call 186
 - Display message 217
 - Menu (on-board computer) 186
 - Number from the phone book 187
 - Redialing 187
 - Rejecting/ending a call 186
 - Temperature**
 - Coolant 179
 - Outside temperature 179
 - Setting (climate control) 119
 - Theft deterrent systems**
 - ATA (Anti-Theft Alarm system) 65
 - Immobilizer 65
 - Through-loading** 233
 - Time**
 - see Separate Operator's Manual
 - TIREFIT kit** 276
 - Tire pressure**
 - Checking manually 298
 - Display message 214
 - Maximum 298
 - Notes 297
 - Not reached (TIREFIT) 278
 - Reached (TIREFIT) 278
 - Recommended 295
 - Tire pressure loss warning system**
 - Important safety notes 298
 - Restarting 299
 - Tires**
 - Aspect ratio (definition) 311

- Average weight of the vehicle
- occupants (definition) 309
- Bar (definition) 309
- Changing a wheel 312
- Characteristics 309
- Checking 293
- Definition of terms 309
- Direction of rotation 312
- Display message 214
- Distribution of the vehicle
- occupants (definition) 311
- DOT, Tire Identification Number (TIN) 308
- DOT (Department of Transportation) (definition) 309
- GAWR (Gross Axle Weight Rating) (definition) 310
- GVW (Gross Vehicle Weight) (definition) 310
- GVWR (Gross Vehicle Weight Rating) (definition) 310
- Important safety notes 292
- Increased vehicle weight due to optional equipment (definition) 309
- Kilopascal (kPa) (definition) 310
- Labeling (overview) 305
- Load bearing index (definition) 311
- Load index 308
- Load index (definition) 310
- M+S tires 294
- Maximum loaded vehicle weight (definition) 310
- Maximum load on a tire (definition) 310
- Maximum permissible tire pressure (definition) 310
- Maximum tire load 303
- Maximum tire load (definition) 310
- MOExtended tires 294
- Optional equipment weight (definition) 311
- PSI (pounds per square inch) (definition) 310
- Replacing 312
- Service life 294
- Sidewall (definition) 311
- Speed rating (definition) 310
- Storing 312
- Structure and characteristics (definition) 309
- Summer tires 294
- Temperature 305
- TIN (Tire Identification Number) (definition) 311
- Tire bead (definition) 311
- Tire pressure (definition) 311
- Tire pressures (recommended) 309
- Tire size (data) 316
- Tire size designation, load-bearing capacity, speed rating 306
- Tire tread 293
- Tire tread (definition) 311
- Total load limit (definition) 311
- Traction 304
- Traction (definition) 311
- Tread wear 304
- Uniform Tire Quality Grading Standards 304
- Uniform Tire Quality Grading Standards (definition) 309
- Unladen weight (definition) 310
- Wear indicator (definition) 311
- Wheel rim (definition) 309
- see Flat tire
- Top Tether** 52
- Towing**
- Important safety guidelines 285
- Installing the towing eye 286
- Removing the towing eye 286
- Towing away**
- With both axles on the ground 286
- With front axle raised 286
- Tow-starting**
- Emergency engine starting 287
- Important safety notes 285
- Installing the towing eye 286
- Removing the towing eye 286
- Traction control** 63
- Transmission**
- see Automatic transmission
- Transmission position display** 133
- Transporting the vehicle** 287
- Trim pieces (cleaning instructions)** . 270
- Trip computer (on-board computer)** 182

- Trip odometer**
 - Calling up 182
 - Resetting (on-board computer) 183
 - Trunk**
 - see Tailgate
 - Turn signals**
 - Changing bulbs (front) 106
 - Changing bulbs (rear) 107
 - Display message 203
 - Switching on/off 98
 - Type identification plate**
 - see Vehicle identification plate
- U**
- Unlocking**
 - Emergency unlocking 75
 - From inside the vehicle (central unlocking button) 74
- V**
- Vanity mirror (in the sun visor) 242**
 - Vehicle**
 - Correct use 24
 - Data acquisition 24
 - Equipment 21
 - Individual settings 189
 - Limited Warranty 24
 - Loading 300
 - Locking (in an emergency) 75
 - Locking (SmartKey) 68
 - Lowering 315
 - Maintenance 21
 - Parking for a long period 144
 - Pulling away 127
 - Raising 313
 - Reporting problems 24
 - Securing from rolling away 313
 - Towing away 285
 - Tow-starting 285
 - Transporting 287
 - Unlocking (in an emergency) 75
 - Unlocking (SmartKey) 68
 - Vehicle data 329
 - Vehicle data 329**
 - Vehicle dimensions 329**
 - Vehicle emergency locking 75**
 - Vehicle identification number**
 - see VIN
 - Vehicle identification plate 323**
 - Vehicle tool kit 274**
 - Video (DVD) 186**
 - VIN 323**
- W**
- Warning and indicator lamps**
 - ABS 220
 - Brakes 220
 - Check Engine 226
 - Coolant 226
 - Distance warning 228
 - DISTRONIC PLUS 228
 - ESP® 222
 - ESP® OFF 223
 - Fuel tank 226
 - Overview 28
 - PASSENGER AIRBAG OFF 50
 - Reserve fuel 226
 - Seat belt 218
 - SRS 225
 - Warranty 323**
 - Washer fluid**
 - Display message 217
 - Wheel bolt tightening torque 315**
 - Wheel chock 313**
 - Wheels**
 - Changing a wheel 312
 - Checking 293
 - Cleaning 267
 - Cleaning (warning) 312
 - Emergency spare wheel 318
 - Important safety notes 292
 - Interchanging/changing 312
 - Mounting a new wheel 315
 - Mounting a wheel 312
 - Removing a wheel 315
 - Storing 312
 - Tightening torque 315
 - Wheel size/tire size 316
 - Window curtain air bag**
 - Display message 202
 - Operation 42
 - Windows**
 - see Side windows

Windshield	
Defrosting	121
Windshield washer fluid	
see Windshield washer system	
Windshield washer system	
Adding washer fluid	263
Filling capacity	329
Notes	328
Windshield wipers	
Problem (malfunction)	111
Rear window wiper	110
Replacing the wiper blades	110
Switching on/off	109
Winter driving	
Slippery road surfaces	149
Snow chains	295
Winter operation	
General notes	294
Winter tires	
M+S tires	294
Wiper blades	
Cleaning	268
Important safety notes	110
Replacing (rear window)	111
Replacing (windshield)	110
Wooden trim (cleaning instructions)	270
Workshops	
see Qualified specialist workshop	

Protection of the environment

General notes

📌 Environmental note

Daimler's declared policy is one of integrated environmental protection.

The objectives are for the natural resources that form the basis of our existence on this planet to be used sparingly and in a manner that takes the requirements of both nature and humanity into account.

You too can help to protect the environment by operating your vehicle in an environmentally responsible manner.

Fuel consumption and the rate of engine, transmission, brake and tire wear depend on the following factors:

- operating conditions of your vehicle
- your personal driving style

You can influence both factors. You should bear the following in mind:

Operating conditions:

- avoid short trips as these increase fuel consumption.
- always make sure that the tire pressures are correct.
- do not carry any unnecessary weight.
- keep an eye on the vehicle's fuel consumption.
- remove roof racks once you no longer need them.
- a regularly serviced vehicle will contribute to environmental protection. You should therefore adhere to the service intervals.
- always have service work carried out at a qualified specialist workshop.

Personal driving style:

- do not depress the accelerator pedal when starting the engine.
- do not warm up the engine when the vehicle is stationary.
- drive carefully and maintain a safe distance from the vehicle in front.

- avoid frequent, sudden acceleration.
- change gear in good time and use each gear only up to $\frac{2}{3}$ of its maximum engine speed.
- switch off the engine in stationary traffic.

Environmental concerns and recommendations

Wherever the operating instructions require you to dispose of materials, first try to regenerate or re-use them. Observe the relevant environmental rules and regulations when disposing of materials. In this way you will help to protect the environment.

Product information

Mercedes-Benz recommends that you use genuine Mercedes-Benz parts, conversion parts and accessories that have been approved for your vehicle.

Mercedes-Benz tests genuine parts as well as conversion parts and accessories that have been specifically approved for your vehicle for their reliability, safety and suitability. Despite ongoing market research, Mercedes-Benz is unable to assess other parts. Therefore, Mercedes-Benz accepts no responsibility for the use of such parts in Mercedes-Benz vehicles. This is also the case, even if they have been independently or officially approved. The use of non-approved parts could affect your vehicle's operating safety. Genuine Mercedes-Benz parts, approved conversion parts and accessories are available from any authorized Mercedes-Benz Center. Here, you will receive advice about permissible technical modifications, and the parts will be professionally installed.

Operator's Manual

General notes

Before you first drive off, read this Operator's Manual carefully and familiarize yourself with your vehicle.

For your own safety and a longer vehicle life, follow the instructions and warning notices in this manual. Disregarding them may lead to damage to the vehicle or personal injury.

Vehicle damage resulting from the disregard of the instructions is not covered by the Mercedes-Benz Limited Warranty.

Vehicle equipment

This Operator's Manual describes all models and all standard and optional equipment of your vehicle available at the time of going to print. Country-specific differences are possible. Please note that your vehicle may not be equipped with all features described. This also applies to safety-related systems and functions. The equipment in your vehicle may therefore differ from some of the descriptions or illustrations.

The original purchase agreement lists all systems installed in your vehicle.

Contact an authorized Mercedes-Benz Center if you have any questions about equipment or operation.

The Operator's Manual and Maintenance Booklet are important documents and should be kept in the vehicle.

Service and vehicle operation

Service and literature

Your vehicle is covered under the terms of the warranties printed in the Service and Warranty Information booklet. Your authorized Mercedes-Benz Center will exchange or repair any defective parts originally installed in the vehicle in accordance with the terms of the following warranties:

- New Vehicle Limited Warranty
- Emission Systems Warranty
- Emission Performance Warranty
- California, Connecticut, Maine, Massachusetts, New York, Pennsylvania, Rhode Island and Vermont Emission Control Systems Warranty
- State warranty enforcement laws (lemon laws)

Maintenance

The Service and Warranty Booklet describes all the necessary maintenance work which should be done at regular intervals.

Always have the Service and Warranty Booklet with you when you bring the vehicle to an authorized Mercedes-Benz Center. The service advisor will record every service for you in the Service and Warranty Booklet.

Roadside Assistance

The Mercedes-Benz Roadside Assistance Program offers technical help in the event of a breakdown. Calls to the toll-free Roadside Assistance Hotline are answered by our agents 24 hours a day, 365 days a year.

**1-800-FOR-MERCEdes(1-800-367-6372)
(USA)**

1-800-387-0100 (Canada)

For additional information, refer to the Mercedes-Benz Roadside Assistance Program brochure (USA) or the "Roadside

Assistance" section in the Service and Warranty booklet (Canada). You will find both in your vehicle literature portfolio.

Change of address or change of ownership

In the event of a change of address, please send us the "Notification of Address Change" in the Service and Guarantee booklet or simply call the Mercedes-Benz Customer Assistance Center (USA) at the hotline number 1-800-FOR-MERCEdes(1-800-367-6372) or Customer Service Center (Canada) at 1-800-387-0100. This will assist us in contacting you in a timely manner should the need arise.

If you sell your Mercedes, please leave the entire literature in the vehicle so that it is available to the next owner.

If you have purchased a used car, please send us the "Notification of Used Car Purchase" in the Service and Guarantee booklet or simply call the Mercedes-Benz Customer Assistance Center (USA) at the hotline number 1-800-FOR-MERCEdes(1-800-367-6372) or Customer Service (Canada) at 1-800-387-0100.

Vehicle operation outside Canada

If you plan to operate your vehicle in foreign countries, please be aware that:

- service facilities or replacement parts may not be readily available.
- unleaded fuel for vehicles with a catalytic converter may not be available. Leaded fuel may cause damage to the catalytic converter.
- the fuel may have a considerably lower octane rating. Unsuitable fuel can cause engine damage.

Some Mercedes-Benz models are available for delivery in Europe through our European Delivery Program. For details, consult an

authorized Mercedes-Benz Center or write to one of the following addresses.

In the USA

Mercedes-Benz USA, LLC
European Delivery Department
One Mercedes Drive
Montvale, NJ 07645-0350

In Canada

Mercedes-Benz Canada, Inc.
European Delivery Department
98 Vanderhoof Avenue
Toronto, Ontario M4G 4C9

Operating safety

Important safety notes

WARNING

Work improperly carried out on electronic components and associated software could cause them to cease functioning. Because the vehicle's electronic components are interconnected, any modifications made may produce an undesired effect on other systems. Electronic malfunctions could seriously impair the operating safety of your vehicle.

Contact an authorized Mercedes-Benz Center for repairs or modifications to electronic components.

Other improper work or modifications on the vehicle could also have a negative impact on the operating safety of the vehicle.

Some safety systems only function when the engine is running. You should therefore never turn off the engine while driving.

WARNING

Heavy blows against the vehicle underbody or tires/wheels may cause serious damage and impair the operating safety of your vehicle. Such blows can be caused, for example, by running over an obstacle, road debris or a pothole.

If you feel a sudden significant vibration or ride disturbance, or you suspect that damage to your vehicle has occurred:

- turn on your hazard warning flashers.
- slow down carefully.
- drive with caution to an area which is a safe distance from the road.

Inspect the vehicle underbody and tires/wheels for possible damage. If the vehicle appears unsafe, have it towed to the nearest authorized Mercedes-Benz Center or other qualified maintenance or repair facility for further inspection or repairs.

Declarations of conformity

Vehicle components which receive and/or transmit radio waves

USA: "The wireless devices of this vehicle comply with Part 15 of the FCC Rules. Operation is subject to the following two conditions: 1) These devices may not cause harmful interference, and 2) These devices must accept any interference received, including interference that may cause undesired operation. Changes or modifications not expressly approved by the party responsible for compliance could void the user's authority to operate the equipment."

Canada: "The wireless devices of this vehicle comply with Industry Canada license-exempt RSS standard(s). Operation is subject to the following two conditions: (1) These devices may not cause interference, and (2) These devices must accept any interference, including interference that may cause undesired operation of the device."

Diagnostics connection

WARNING

If you connect equipment to the on-board diagnostics connection, it can affect the

operation of the vehicle systems. This can impair the operating safety of your vehicle while driving. There is a risk of an accident.

Do not connect any equipment to the on-board diagnostics connection.

WARNING

Loose equipment or equipment cables which are connected to the on-board diagnostics connection can obstruct the area around the pedals. The equipment or the cables could come between the pedals in the event of sudden braking or acceleration. This may affect the function of the pedals. There is a risk of an accident.

Do not attach any equipment or cables in the driver's footwell.

- ❗ If the engine is switched off and equipment on the diagnostics connection is used, the starter battery may discharge.

The diagnostics connection is only intended for the connection of diagnostic equipment at a qualified specialist workshop.

Connecting equipment to the diagnostics connection can, for example, lead to emissions monitoring information being reset. This may lead to the vehicle failing to meet the requirements of the next emissions test during the main inspection.

Qualified specialist workshop

An authorized Mercedes-Benz Center is a qualified specialist workshop. It has the necessary specialist knowledge, tools and qualifications to correctly carry out the work required on your vehicle. This is especially the case for work relevant to safety.

Observe the notes in the Maintenance Booklet.

Always have the following work carried out at an authorized Mercedes-Benz Center:

- work relevant to safety
- service and maintenance work

- repair work
- alterations, installation work and modifications
- work on electronic components

Correct use

WARNING

There are various warning stickers affixed to your vehicle. Their purpose is to alert you and others to various dangers. Therefore, do not remove any warning stickers unless the sticker clearly states that you may do so.

If you remove any warning stickers, you or others could fail to recognize certain dangers and be injured.

When driving your vehicle observe the following information:

- the safety notes in this manual
- the Technical Data section in this manual
- traffic rules and regulations
- laws and safety standards pertaining to motor vehicles

Problems with your vehicle

If you should experience a problem with your vehicle, particularly one that you believe may affect its safe operation, we urge you to contact an authorized Mercedes-Benz Center immediately to have the problem diagnosed and rectified. If the problem is not resolved to your satisfaction, please discuss the problem again with a Mercedes-Benz Center or contact us at one of the following addresses.

In the USA

Customer Assistance Center
Mercedes-Benz USA, LLC
One Mercedes Drive
Montvale, NJ 07645-0350

In Canada

Customer Relations Department
Mercedes-Benz Canada, Inc.

98 Vanderhoof Avenue
Toronto, Ontario M4G 4C9

Limited Warranty

I Follow the instructions in this manual about the proper operation of your vehicle as well as about possible vehicle damage. Damage to your vehicle that arises from culpable contraventions against these instructions is not covered either by the Mercedes-Benz Limited Warranty or by the New or Used-Vehicle Warranty.

Data stored in the vehicle

Information about electronic data acquisition in the vehicle

(Including notice pursuant to California Code § 9951)

Your vehicle records electronic data. If your vehicle is equipped with mbrace (Canada: TELE AID), data is transmitted in the event of an accident.

This information helps, for example, to test vehicle systems after an accident and to continually improve vehicle safety. Daimler AG can access this data and submit it:

- for safety research or vehicle diagnosis purposes
- with the consent of the vehicle owner
- on the instruction of prosecuting authorities
- for use in arbitration of disputes that involve Daimler AG, its affiliates or its sales and service organizations
- as otherwise required or permitted by law.

Please check your mbrace (Canada: TELE AID) purchase agreement to find out more about data that can be recorded and transmitted by this system.

Cockpit 26
Instrument cluster 27
Multifunction steering wheel 29
Center console 30
Overhead control panel 32
Door control panel 33



Cockpit

At a glance

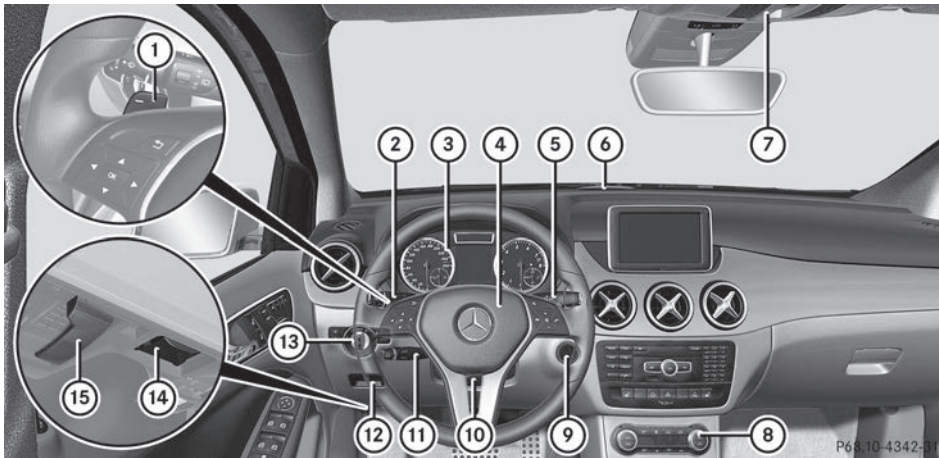

	Function	Page
①	Steering wheel paddle shifters	136
②	Combination switch	98
③	Instrument cluster	27
④	Horn	
⑤	DIRECT SELECT lever	133
⑥	PARKTRONIC warning display	161
⑦	Overhead control panel	32
⑧	Climate control systems	114

	Function	Page
⑨	Ignition lock	127
⑩	Adjusting the steering wheel	89
⑪	Cruise control lever	150
⑫	Electric parking brake	142
⑬	Light switch	96
⑭	Diagnostics connection	23
⑮	Opening the hood	260

Instrument cluster

Displays and controls



P54.32-9896-31

At a glance

	Function	Page
①	Speedometer with segments	179
②	Multifunction display	181
③	Tachometer	179

	Function	Page
④	Coolant temperature	179
⑤	Fuel gage	
⑥	Instrument lighting	178

Warning and indicator lamps



P54.32-9899-31







	Function	Page
①	Low-beam headlamps	97
②	Parking lamps	98
③	High-beam headlamps	98
④	ESP®	222
⑤	Electric parking brake (red)	225
⑥	Electric parking brake (yellow)	225
⑦	Distance warning	228
⑧	Turn signals	98







	Function	Page
⑨	SRS	225
⑩	Seat belt	218
⑪	Coolant	226
⑫	Rear fog lamp	98
⑬	Front fog lamps	97
⑭	Check Engine	226
⑮	Reserve fuel	226
⑯	ESP® OFF	222
⑰	ABS	220
⑱	Brakes	220

Multifunction steering wheel



At a glance

	Function	Page
①	Multifunction display	181
②	Audio/COMAND display; see the separate operating instructions	
③	 Switches on the Voice Control System; see the separate operating instructions	
④	 Rejects or ends a call Exits phone book/redial memory  Makes or accepts a call Switches to the redial memory   Adjusts the volume  Mute	186

	Function	Page
⑤	  Selects a menu   Selects a submenu or scrolls through lists  Confirms your selection Hides display messages	180
⑥	 Back Switches off the Voice Control System; see the separate operating instructions	180

P46.10-3181-31



Center console

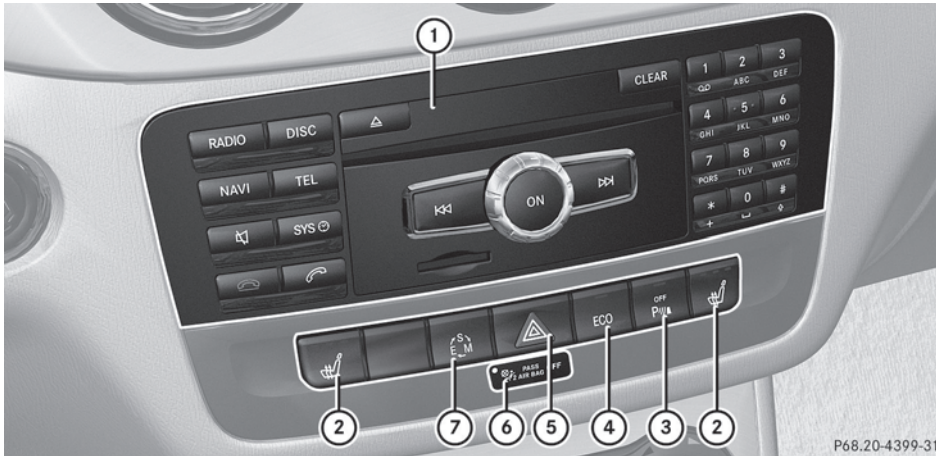

Center console, upper section

At a glance



P68.20-4399-31

	Function	Page
①	Audio system/COMAND; see the separate operating instructions	
②	 Seat heating	89
③	 PARKTRONIC	161
④	 ECO start/stop function	128

	Function	Page
⑤	 Hazard warning lamps	99
⑥	 PASSENGER AIRBAG OFF indicator lamp	50
⑦	 Selects the drive program	135

Center console, lower section

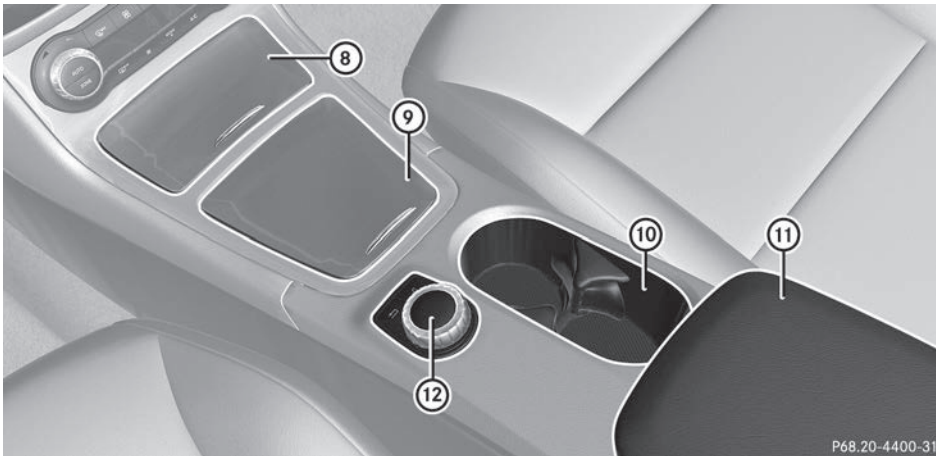

At a glance

	Function	Page		Function	Page
⑧	Ashtray	242	⑩	Cup holders	241
	Cigarette lighter	243		⑪	Stowage compartment
	Power socket	244	⑫		Audio/COMAND controller; see the separate operating instructions
	Stowage compartment	230			
⑨	Stowage compartment	230			

Overhead control panel

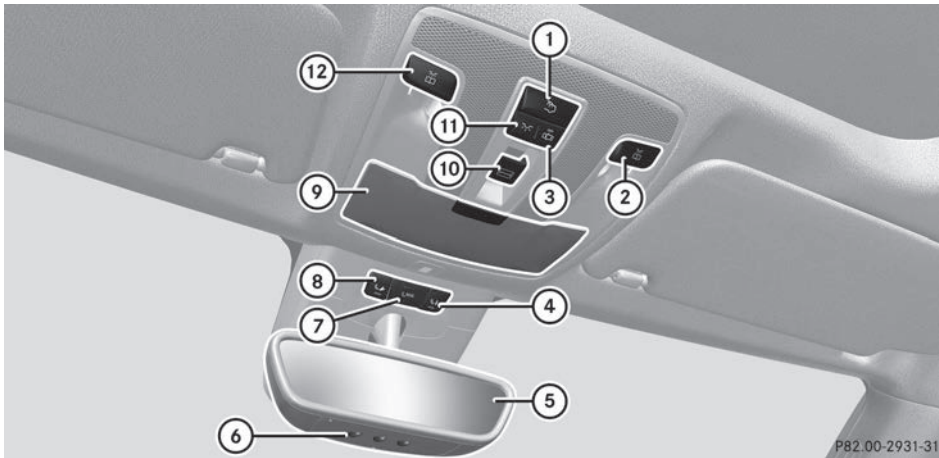

P82.00-2931-31

	Function	Page
①	Switches the rear interior lighting on/off	102
②	Switches the right-hand reading lamp on/off	101
③	Switches the front interior lighting/automatic interior lighting control off	102
④	MB Info call button (mbrace system)	248
⑤	Rear-view mirror	90
⑥	Buttons for the garage door opener	256
⑦	SOS button (mbrace system)	246

	Function	Page
⑧	Roadside Assistance call button (mbrace system)	247
⑨	Eyeglasses compartment	231
⑩	Opens/closes the panorama roof with power tilt/sliding panel with roller sunblinds	80
⑪	Switches the front interior lighting on	102
⑫	Switches the left-hand reading lamp on/off	101

Door control panel

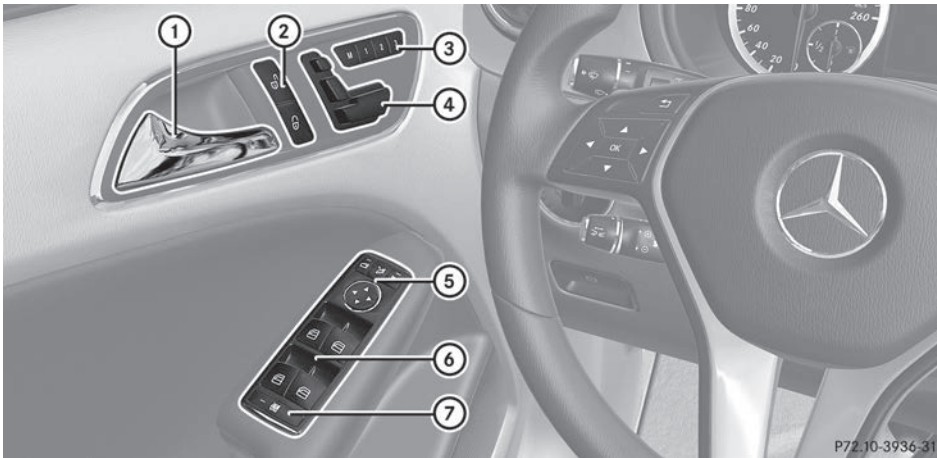

At a glance

	Function	Page
①	Opens the door	74
②	Unlocks/locks the vehicle	74
③	Saves the seat and exterior mirror settings	93
④	Adjusts the seats electrically	87
⑤	Adjusts and folds the exterior mirrors in/out electrically	90

	Function	Page
⑥	Opens/closes the side windows	78
⑦	Activates/deactivates the override feature for the side windows in the rear compartment	58

P72.10-3936-31

Useful information	36
Panic alarm	36
Occupant safety	36
Children in the vehicle	47
Driving safety systems	59
Theft deterrent locking system	65

Useful information

- i** This Operator's Manual describes all models and all standard and optional equipment of your vehicle available at the time of publication of the Operator's Manual. Country-specific differences are possible. Please note that your vehicle may not be equipped with all features described. This also applies to safety-related systems and functions.
- i** Please read the information on qualified specialist workshops (▷ page 23).

Panic alarm



- ▶ **To activate:** press **PANIC** button ① for at least one second.
An alarm sounds and the exterior lighting flashes.
 - ▶ **To deactivate:** press **PANIC** button ① again.
- or
- ▶ Insert the SmartKey into the ignition lock.
 - i** This device complies with RSS-Gen of Industry Canada. Operation is subject to the following two conditions:
 1. This device may not cause interference, and
 2. this device must accept any interference received, including interference that may cause undesired operation.

Any unauthorized modification to this device could void the user's authority to operate the equipment.

The Product label with FCC ID and IC certification number can be found in the battery case of the SmartKey.

Occupant safety

Important safety notes

⚠ WARNING

Modifications to or work improperly conducted on restraint system components or their wiring, as well as tampering with interconnected electronic systems, can lead to the restraint systems no longer functioning as intended.

Air bags or Emergency Tensioning Devices (ETDs), for example, could deploy inadvertently or fail to deploy in accidents although the deceleration threshold for air bag deployment is exceeded. Therefore, never modify the restraint systems. Do not tamper with electronic components or their software.

In this section, you will learn the most important facts about the restraint system components of the vehicle.

The restraint system consists of:

- seat belts
- child restraint systems
- LATCH-type (ISOFIX) child seat anchors

Additional protection is provided by:

- SRS (Supplemental Restraint System)
- PRE-SAFE®
- Air bag system components with the PASSENGER AIR BAG OFF indicator lamp

The different air bag systems work independently of each other. The protective functions of the system work in conjunction with each other. Not all air bags are always deployed in an accident.

- i** For information on infants and children traveling with you in the vehicle restraint systems for infants and children, see "Children in the vehicle" (▷ page 47).

SRS (Supplemental Restraint System)

Introduction

SRS consists of:

- the  SRS warning lamp
- air bags
- air bag control unit (with crash sensors)
- Emergency Tensioning Devices for the front seat belts and the outer seat belts in the rear
- seat belt force limiters for the front seat belts and the outer seat belts in the rear

SRS reduces the risk of occupants coming into contact with the vehicle's interior in the event of an accident. It can also reduce the effect of the forces to which occupants are subjected during an accident.

SRS warning lamp

WARNING

The SRS self-check has detected a malfunction if the  SRS indicator lamp:

- does not light up at all
- does not go out after approximately four seconds after the engine is started
- lights up after the engine is started or while the vehicle is in motion

For your safety, Mercedes-Benz strongly recommends that you have the system checked as soon as possible at a qualified specialist workshop. SRS may otherwise fail to activate when it is needed in the event of an accident, which could lead to serious or fatal injuries. SRS might also be activated unexpectedly and unnecessarily, which could also result in injury.

In addition, work carried out improperly on SRS may render SRS inoperative or cause

unintended air bag deployment. Work on the SRS system should only be carried out by qualified specialist personnel. Consult a qualified specialist workshop.

If it is necessary to modify an air bag system to accommodate a person with disabilities, contact an authorized Mercedes-Benz Center for details. USA only: for further information, contact our Customer Assistance Center at 1-800-FOR-MERCEDES (1-800-367-6372).

The  SRS warning lamp in the instrument cluster lights up when the ignition is switched on. It goes out no later than a few seconds after the engine is started.

SRS functions are checked regularly when the engine is running. Therefore, malfunctions can be detected in good time.

The SRS components are in operational readiness when the  SRS warning lamp goes out while the engine is running.

Triggering of Emergency Tensioning Devices (ETDs), belt force limiters and air bags

During the first stage of a collision, the air bag control unit evaluates important physical data relating to vehicle deceleration or acceleration, such as:

- duration
- direction
- magnitude

Based on the evaluation of this data, the air bag control unit pre-emptively triggers the belt tensioners in the first stage.

If there is an even higher rate of vehicle deceleration or acceleration in a longitudinal direction, the front air bags are also deployed.

Your vehicle has adaptive, two-stage front air bags. The air bag control unit evaluates vehicle deceleration or acceleration in the event of a collision. In the first deployment stage, the front air bag is filled with enough propellant gas to reduce the risk of injuries. The front air bag is fully deployed if a second

deployment threshold is reached within a few milliseconds.

The Emergency Tensioning Device and air bag triggering thresholds are variable and are adapted to the detected rate of deceleration or acceleration of the vehicle. This process is pre-emptive in nature. The triggering process must take place in good time at the start of the collision.

The rate of vehicle deceleration or acceleration and the direction of the force are essentially determined by:

- the distribution of forces during the collision
- the collision angle
- the deformation characteristics of the vehicle
- the characteristics of the object with which the vehicle has collided

Factors that can only be seen and measured after a collision has occurred do not play a decisive role in the deployment of an air bag, nor do they provide an indication of air bag deployment.

The vehicle may be deformed significantly, e.g. the hood or the fender, without an air bag being deployed. This is the case if only parts which are relatively easily deformed are affected and the rate of deceleration is not high. Conversely, air bags may be deployed even though the vehicle suffers only minor deformation. This is the case if, for example, very rigid vehicle parts such as longitudinal body members are hit, and sufficient deceleration occurs as a result.

- **i** The front Emergency Tensioning Devices can only be triggered if the seat belt tongues on the front seats are correctly engaged in the seat belt buckles.
- **i** Not all air bags are deployed in an accident. The different air bag systems work independently of each other.

How the air bag system works is determined by predicting the severity of the accident, especially vehicle deceleration or acceleration, and the type of accident:

- head-on collision
- side impact

Safety guidelines for seat belts, Emergency Tensioning Devices (ETDs) and air bags

WARNING

- Damaged seat belts or seat belts that have been subjected to stress in an accident must be replaced. Their anchoring points must also be checked. Only use seat belts installed or supplied by an authorized Mercedes-Benz Center.
- Air bags and pyrotechnic Emergency Tensioning Devices (ETDs) contain perchlorate material, which may require special handling and regard for the environment. Check your national disposal guidelines. California residents, see www.dtsc.ca.gov/HazardousWaste/Perchlorate/index.cfm.
- Air bags and ETDs are designed to function on a one-time-only basis. An air bag or ETD that has deployed must be replaced. PRE-SAFE® has electrically operated reversible belt tensioners in addition to the pyrotechnic ETDs.
- Do not pass seat belts over sharp edges. They could tear.
- Do not make any modification that could change the effectiveness of the seat belts.
- Do not bleach or dye seat belts as this may severely weaken them. In a crash they may not be able to provide adequate protection.
- No modifications of any kind may be made to any components or wiring of the SRS.
- Do not change or remove any component or part of the SRS.

- Do not install additional trim material, seat covers, badges, etc. to the:
 - padded steering wheel boss
 - knee bag covers
 - front-passenger air bag cover
 - outer side of front seat bolsters
 - outer side of rear bench seat backrest seat bolsters
 - roof lining trim
- Do not install additional electrical/ electronic equipment on or near SRS components and wiring.
- Keep area between air bags and occupants free of objects (e.g. packages, purses, umbrellas, etc.).
- Do not hang items such as coat hangers from the coat hooks or handles over the door. These items may be thrown around in the vehicle and cause head and other injuries when the window curtain air bag is deployed.
- Air bag system components will be hot after an air bag has inflated. Do not touch them.
- Never place your feet on the instrument panel, dashboard, or on the seat. Always keep both feet on the floor in front of the seat.
- Improper repair work on the SRS creates a risk of rendering the SRS inoperative or causing unintended air bag deployment. Work on the SRS must therefore only be performed by qualified technicians. Contact an authorized Mercedes-Benz Center.
- For your protection and the protection of others, when scrapping the air bag unit or ETD, our safety instructions must be followed. These instructions are available from any authorized Mercedes-Benz Center.
- Given the considerable deployment speed, required inflation volume, and the material of the air bags, there is the possibility of abrasions or other, potentially more serious injuries resulting from air bag deployment.

If you sell your vehicle, Mercedes-Benz strongly recommends that you inform the subsequent owner that the vehicle is equipped with SRS. Also, refer them to the applicable section in the Operator's Manual.

Air bags

Important safety notes

WARNING

Air bags are designed to reduce the incidence of injuries and fatalities in certain situations:

- frontal impacts (driver's and front-passenger front air bags and driver's knee bag)
- side impacts (side impact air bags and window curtain air bags)
- rollover (window curtain air bags)

However, no system available today can completely eliminate injuries and fatalities. When the air bags are deployed, a small amount of powder is released. The powder generally does not constitute a health hazard and does not indicate that there is a fire in the vehicle. In order to prevent potential breathing difficulties, you should leave the vehicle as soon as it is safe to do so. If you have any breathing difficulty but cannot get out of the vehicle after the air bag inflates, then get fresh air by opening a window or door.

WARNING

In order to reduce the potential danger of injuries caused during the deployment of the front air bags, the driver and front passenger must always be correctly seated and wear their seat belts.

For maximum protection in the event of a collision, you must always be in the normal seat position with your back against the backrest. Fasten your seat belt and make sure that it is correctly positioned on your body.

As the air bag inflates with considerable speed and force, a proper seating position and correct positioning of the hands on the steering wheel will help to keep you at a safe distance from the air bag. Occupants who are not wearing their seat belt, are not seated properly or are too close to the air bag can be seriously injured or killed by an air bag, as it inflates with great force instantaneously:

- sit with the seat belt fastened correctly and in a position that is as upright as possible with your back against the backrest.
- move the driver's seat as far back as possible, still permitting proper operation of vehicle controls. The distance from the center of the driver's chest to the center of the air bag cover on the steering wheel must be at least 10 inches (25 cm). You should be able to accomplish this by adjusting the seat and steering wheel. If you have any difficulties, please contact an authorized Mercedes-Benz Center.
- do not lean your head or chest close to the steering wheel or dashboard.
- only hold the steering wheel on the outside. Placing hands and arms inside the rim can increase the risk and potential severity of hand/arm injury if the driver front air bag inflates.
- adjust the front-passenger seat as far back as possible from the dashboard when the seat is occupied.
- occupants, especially children, should never place their bodies or lean their heads in the area of the door where the side impact air bag inflates. This could result in serious or fatal injuries should the side impact air bag be deployed. Always sit as upright as possible, wear the seat belt properly and use an appropriately sized infant restraint, toddler restraint or booster seat recommended for the size and weight of the child.

Failure to follow these instructions can result in severe injuries to you or other occupants.

If you sell your vehicle, it is important that you make the buyer aware of this safety information. Be sure to give the buyer this Operator's Manual.

WARNING

Accident research shows that the safest place for children in an automobile is in a rear seat. A side impact air bag related injury may occur if occupants, especially children, are not properly seated or restrained when next to a side impact air bag which needs to deploy rapidly in a side impact in order to do its job. To help avoid the possibility of injury, please follow these guidelines:

- (1) Always sit as upright as possible and use the seat belts properly. Make sure that children 12 years old and under use an appropriately sized child restraint, infant restraint, or booster seat recommended for the size and weight of the child.
- (2) Always wear seat belts properly.

If the air bags are deployed, you will hear a bang, and a small amount of powder may also be released. Only in rare cases will the bang affect your hearing. The powder that is released generally does not constitute a health hazard. The  SRS warning lamp lights up.

The air bags are only deployed if the air bag control unit detects the need for deployment. Only in the event of such a situation will the air bags provide their supplemental protection.

If the driver and front passenger do not wear their seat belts, it is not possible for the air bags to provide their supplemental protection.

In the event of other types of impacts and impacts below air bag deployment thresholds, the air bags will not deploy. The driver and passengers will then be protected to the extent possible by a properly fastened

seat belt. A properly fastened seat belt is also needed to provide the best possible protection if the vehicle rolls over.

Air bags are not a substitute for seat belts.

Always wear your seat belt, regardless of whether or not your vehicle is equipped with air bags.

It is important for your safety and that of your passengers to have deployed air bags replaced and to have any malfunctioning air bags repaired. This will help to make sure the air bags will continue to provide supplemental crash protection for occupants.

Front air bags

! Make sure that there are no objects exerting force on the front-passenger seat. This could cause the system to identify the seat as being occupied, and in the event of an accident, the restraint systems on the front-passenger side might be triggered. Have triggered restraint systems replaced.

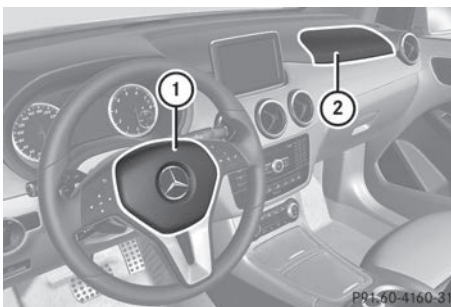

Driver's air bag ① deploys in front of the steering wheel; front-passenger front air bag ② deploys in front of and above the glove box.

The front air bags increase protection for the driver's and front-passenger's head and chest.

They are deployed:

- in the event of certain frontal impacts
- if the system determines that air bag deployment can offer additional protection to that provided by the seat belt

- depending on whether the seat belt is being used
- independently of other air bags in the vehicle

If the vehicle overturns, the front air bags are generally not deployed. If the system detects high vehicle deceleration in a longitudinal direction, the front air bags are deployed.

Front-passenger air bag ② is only activated if the system determines that the front-passenger seat is occupied. The  PASSENGER AIRBAG OFF indicator lamp on the center console does not light up (> page 50).

When a child restraint system is installed on the front-passenger seat and the  PASSENGER AIRBAG OFF indicator lamp in the center console does not light up:

- a child restraint system without a transponder for the air bag deactivation system is installed or
- a child restraint system with a transponder has not been installed properly.

Your vehicle has adaptive, two-stage front air bags. The air bag control unit evaluates vehicle deceleration or acceleration in the event of a collision. In the first deployment stage, the front air bag is filled with part of the total available propellant gas, thereby reducing the risk of injury. If the air bag control unit recognizes within a few milliseconds that the vehicle is being braked or accelerated faster than originally predicted, the front air bag is filled with the maximum amount of propellant gas available. The lighter the passenger-side occupant, the higher the vehicle deceleration rate required (predicted at the start of the impact) for second stage inflation of the front-passenger front air bag. In the second stage, the front air bags are inflated with the maximum amount of propellant gas available. The front air bags are not deployed in situations where a low impact severity is predicted. You will then be protected by the fastened seat belt.

The front-passenger front air bag will only deploy if:

- the  indicator lamp in the center console is not lit (▷ page 50).
- the air bag control unit predicts a high impact severity

Driver's knee bag

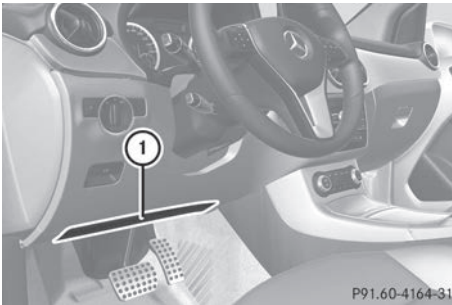

Driver's knee bag ① increases the driver's protection against:

- knee injuries
- thigh injuries
- lower leg injuries

Driver's knee bag ① deploys under the steering column. If, during a frontal collision, the system determines that air bag deployment can offer additional protection to that provided by the seat belt, driver's knee bag ① is deployed along with the driver's air bag. Driver's knee bag ① operates best in conjunction with correctly positioned and fastened seat belts.

Side impact air bags

WARNING

If you wish to use seat covers, Mercedes-Benz recommends that, for safety reasons, you only use seat covers that have been approved for Mercedes-Benz vehicles.

The seat covers must have a special tear seam for sidebags. Otherwise, the sidebags cannot deploy correctly and would fail to provide the intended protection in the event of an

accident. Suitable seat covers can be obtained, for example, from a Mercedes-Benz Service Centre.

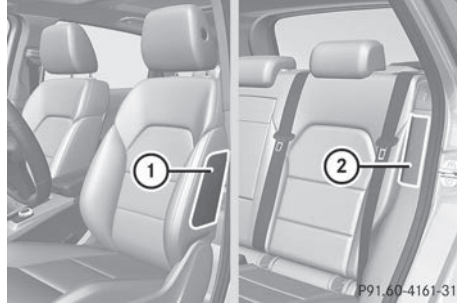

Example: side impact air bags on the driver's side
Front side impact air bags ① and rear side impact air bags ② deploy next to the outer seat cushions.

When deployed, the side impact air bags offer additional protection for the thorax and, on the front seats, the pelvis of the vehicle occupants on the side of the vehicle on which the impact occurs. However, they do not protect the:

- head
- neck
- arms

Window curtain air bags

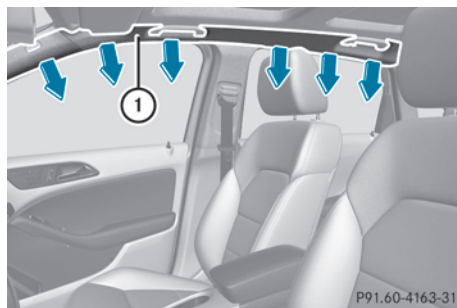

Example: window curtain air bags on the front-passenger side

Window curtain air bags ① are integrated into the side of the roof frame and deploy in the area from the A-pillar to the C-pillar.

When deployed, window curtain air bags ① increase protection for the heads of vehicle occupants on the side of the vehicle on which the impact occurs. However, they do not protect the:

- chest
- arms

They are deployed:

- on the side on which an impact occurs
- at the start of an accident with a high rate of lateral vehicle deceleration or acceleration, e.g. in a side impact
- regardless of whether the front-passenger seat is occupied
- independently of the use of the seat belt
- independently of the front air bags

Window curtain air bags ① will not deploy in impacts with deceleration rates which do not exceed the system's preset deployment thresholds for vehicle deceleration or acceleration. You will then be protected by the fastened seat belt.

Seat belts

Important safety notes

WARNING

Always fasten your seat belt before driving off. Always make sure all of your passengers are properly restrained. You and your passengers should always wear seat belts.

Failure to wear and properly fasten and position your seat belt greatly increases your risk of injuries and their likely severity in an accident.

If you are ever in an accident, your injuries can be considerably more severe without your seat belt properly buckled. Without your seat belt buckled, you are much more likely to hit the interior of the vehicle or be ejected from it. You can be seriously injured or killed.

In the same crash, the possibility of injury or death is lessened if you are properly wearing

your seat belt. The air bags can only protect as intended if the occupants are properly wearing their seat belts.

WARNING

Never ride in a moving vehicle with the seat backrest in an excessively reclined position as this can be dangerous. You could slide under the seat belt in a collision. If you slide under it, the seat belt would apply force at the abdomen or neck. That could cause serious or even fatal injuries. The seat backrest and seat belt provide the best restraint when the wearer is in a position that is as upright as possible and the seat belt is properly positioned on the body.

WARNING

Never let more people ride in the vehicle than there are seat belts available. Make sure everyone riding in the vehicle is correctly restrained with a separate seat belt. Never use a seat belt for more than one person at a time.

WARNING

Damaged seat belts or seat belts that have been subjected to stress in an accident must be replaced and their anchoring points must also be checked.

Only use seat belts which have been approved by Mercedes-Benz.

Do not make any modifications to the seat belts. This can lead to unintended activation of the ETDs or to their failure to activate when necessary.

Do not bleach or dye seat belts as this may severely weaken them. In a crash they may not be able to provide adequate protection.

Have all work carried out only by qualified technicians. Contact an authorized Mercedes-Benz Center.

The use of infant or child restraints is required by law in all 50 states, the District of

Columbia, the U.S. territories and all Canadian provinces.

Even where this is not the case, all vehicle occupants should have their seat belts fastened when the vehicle is in motion.

- See "Children in the vehicle" (> page 47) for further information on infants and children traveling in the vehicle as well as on child restraint systems.

Proper use of the seat belts

WARNING

USE SEAT BELTS PROPERLY

- Seat belts can only work when used properly. Never wear seat belts in any other way than as described in this section, as that could result in serious injuries in the event of an accident.
- Each occupant should wear their seat belt at all times, because seat belts help reduce the likelihood of and potential severity of injuries in accidents, including rollovers. The integrated restraint system includes SRS (driver front air bag, driver's side knee bag, front-passenger front air bag, side impact air bags, window curtain air bags for the side windows), Emergency Tensioning Devices, seat belt force limiters, and front seat knee bolsters.

The system is designed to enhance the protection offered to properly belted occupants in certain frontal (front air bags, driver's side knee bag and ETDs) and side (side impact air bags, window curtain air bags, and ETDs) impacts which exceed preset deployment thresholds and in certain rollovers (window curtain air bags and ETDs).

- Never wear the shoulder belt under your arm, across your neck or off your shoulder. In a frontal crash, your body would move too far forward. That would increase the chance of head and neck injuries. The seat belt would also apply too much force to the ribs or abdomen, which could severely

injure internal organs such as your liver or spleen.

Adjust the seat belt so that the shoulder section is located as close as possible to the middle of the shoulder. It should not touch the neck. Never pass the shoulder portion of the seat belt under your arm. For this purpose, you can adjust the height of the seat belt outlet.

- Position the lap belt as low as possible on your hips and not across the abdomen. If the lap belt is positioned across your abdomen, it could cause serious injuries in a crash.
- Never wear seat belts over rigid or breakable objects in or on your clothing, such as eyeglasses, pens, keys etc., as these might cause injuries.
- Make sure the seat belt is always fitted snugly. Take special care of this when wearing loose clothing.
- Never use a seat belt for more than one person at a time. Do not fasten a seat belt around a person and another person or other objects at the same time.
- Seat belts should not be worn twisted. In a crash, you would not have the full width of the seat belt to distribute impact forces. The twisted seat belt against your body could cause injuries.
- Pregnant women should also always use a lap-shoulder belt. The lap belt portion should be positioned as low as possible on the hips to avoid any possible pressure on the abdomen.
- Place the seat backrest in a position that is as upright as possible.
- Check your seat belt during travel to make sure it is properly positioned.
- Never place your feet on the instrument panel, dashboard, or on the seat. Always keep both feet on the floor in front of the seat.
- When using a seat belt to secure infant restraints, toddler restraints, or children in

booster seats, always follow the child seat manufacturer's instructions.

WARNING

Do not pass seat belts over sharp edges. They could tear.

Do not allow the seat belt to get caught in the door or in the seat adjustment mechanism. This could damage the seat belt.

Never attempt to make modifications to seat belts. This could impair the effectiveness of the seat belts.

Fastening seat belts

WARNING

According to accident statistics, children are safer when properly restrained on the rear seats than on the front-passenger seat. Thus, we strongly recommend that children be placed in the rear seat whenever possible. Regardless of seating position, children 12 years old and under must be seated and properly secured in an appropriately sized child restraint system or booster seat recommended for the size and weight of the child. For additional information, see the "Children in the vehicle" section.

A child's risk of serious or fatal injuries is significantly increased if the child restraints are not properly secured in the vehicle and/or the child is not properly secured in the child restraint.

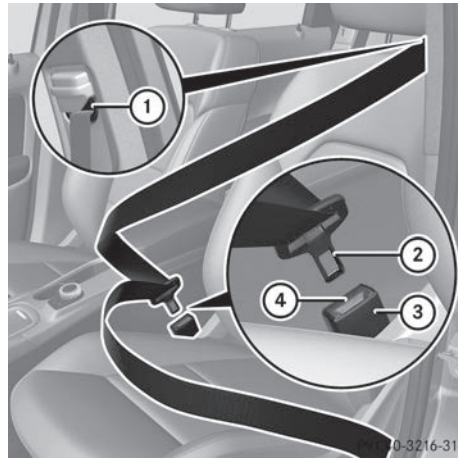

- ▶ Adjust the seat and move the backrest to an almost vertical position (▷ page 84).
- ▶ Pull the seat belt smoothly through belt sash guide ①.
- ▶ Without twisting it, guide the shoulder section of the seat belt across the middle of your shoulder and the lap section across your pelvis.
- ▶ Engage belt tongue ② in buckle ③.
- ▶ If necessary, adjust the seat belt to the appropriate height (▷ page 45).
- ▶ If necessary, pull upwards on the shoulder section of the seat belt to tighten the belt across your body.

For more information about releasing the seat belt with release button ④, see "Releasing seat belts" (▷ page 46).

Belt height adjustment



You can adjust the seat belt height on the front seats. Adjust the belt to a height that allows the upper part of the seat belt to be routed across the center of your shoulder.

- ▶ **To raise:** slide the belt sash guide upwards. The belt sash guide engages in various positions.
- ▶ **To lower:** press and hold belt sash guide release ①.
- ▶ Slide the belt sash guide downwards.
- ▶ Release belt sash guide release ① and make sure that the belt sash guide has engaged.

Releasing seat belts

! Make sure that the seat belt is fully rolled up. Otherwise, the seat belt or belt tongue will be trapped in the door or in the seat mechanism. This could damage the door, the door trim panel and the seat belt. Damaged seat belts can no longer fulfill their protective function and must be replaced. Visit a qualified specialist workshop.

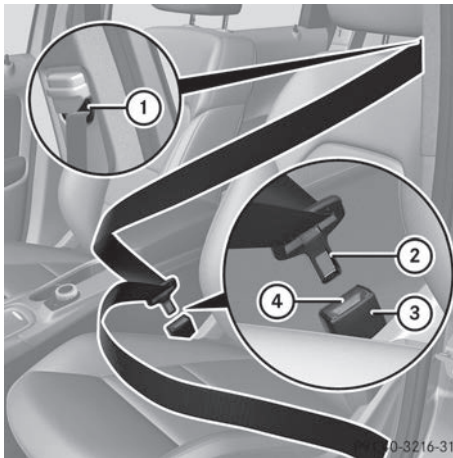

- ▶ Press release button ④ on belt buckle ③.
- ▶ Guide belt tongue ② to belt sash guide ①.

Belt warning for the driver and front passenger

Regardless of whether the driver's and front-passenger seat belts have already been fastened, the  seat belt warning lamp lights up for six seconds each time the engine is started. It then goes out if the driver and the front passenger have fastened their seat belts.

If the driver's seat belt is not fastened when the engine is started, an additional warning tone will sound. The warning tone goes out after approximately six seconds or once the driver's seat belt is fastened.

If after six seconds the driver or front passenger have not fastened their seat belts and the doors are closed, the  seat belt warning lamp lights up:

- until the driver's or front passenger's seat belt is fastened
- once the vehicle has exceeded a speed of 15 mph (25 km/h), in addition a warning tone will sound with increasing intensity for up to 60 seconds or until the driver's or front-passenger seat belt is fastened.

If the driver/front passenger unfasten their seat belt while the vehicle is in motion, the  seat belt warning lamp lights up and a warning tone sounds again.

The warning tone ceases even if the driver or front-passenger seat belt has still not been fastened after 60 seconds. The  seat belt warning lamp stops flashing but remains illuminated.

After the vehicle comes to a standstill, the warning tone is reactivated and the  seat belt warning lamp flashes again if the vehicle speed again exceeds 15 mph (25 km/h).

The  seat belt warning lamp only goes out if:

- both the driver and the front passenger have fastened their seat belts.
- or
- the vehicle is stationary and a door is open.

- i** For more information on the  seat belt warning lamp, see "Warning and indicator lamps in the instrument cluster, seat belts" (> page 218).

Emergency Tensioning Devices, belt force limiters

WARNING

Pyrotechnic Emergency Tensioning Devices that have been deployed must be renewed.

For your safety, when disposing of Emergency Tensioning Devices, always observe the safety instructions. These are available from any authorized Mercedes-Benz Center.

The PRE-SAFE® system has electrically operated reversible pre-tensioners that do not require replacement after activation.

- !** If the front-passenger seat is not occupied, do not engage the seat belt tongue in the buckle on the front-passenger seat. Otherwise, the Emergency Tensioning Device could be triggered in the event of an accident.

The front seat belts and the outer seat belts in the rear are equipped with Emergency Tensioning Devices and belt force limiters.

The ETDs tighten the seat belts in an accident, pulling them close against the body.

The ETDs do not correct incorrect seat positions or incorrectly fastened seat belts.

The ETDs do not pull vehicle occupants back towards the backrest.

If the seat belt is also equipped with a seat belt force limiter and this is triggered, the force exerted by the seat belt on the vehicle occupant is reduced.

The belt force limiters for the front seats are synchronized with the front air bags, which take on a part of the deceleration force. This results in the force exerted on the occupant being distributed over a greater area.

The ETDs can only be activated when:

- the ignition is switched on.
- the restraint systems are operational; see "SRS warning lamp" (> page 37).
- the belt tongue is engaged in the buckle on each of the lap-shoulder belts in the front.

The ETDs on the outside seats in the rear compartment are triggered independently of the lock status of the seat belts.

The ETDs are triggered depending on the type and severity of an accident:

- if, in the event of a head-on or rear-end collision, the vehicle decelerates or accelerates rapidly in a longitudinal direction during the initial stages of the impact
- if, in the event of a side impact, the vehicle is subjected to high lateral acceleration/ deceleration

If the ETDs are deployed, you will hear a bang, and a small amount of powder may also be released. Only in rare cases will the bang affect your hearing. The powder that is released generally does not constitute a health hazard. The  SRS warning lamp lights up.

Children in the vehicle

Child restraint systems

Important safety notes



WARNING

According to accident statistics, children are safer when properly restrained in the rear seating positions than in the front seating position. Thus, we strongly recommend that children be placed in the rear seats whenever possible. Regardless of seating position, children 12 years old and under must be seated and properly secured in an appropriate infant restraint, toddler restraint, or booster seat recommended for the size and weight of the child.

The infant or child restraint must be properly secured with the vehicle's seat belt, the seat belt and top tether strap, or lower anchors and top tether strap, fully in accordance with the child seat manufacturer's instructions.



Occupants, especially children, should always sit as upright as possible, wear the seat belt properly and use an appropriately sized infant restraint, toddler restraint, or booster seat recommended for the size and weight of the child.

Children can be killed or seriously injured by an inflating air bag. Note the following important information when circumstances require you to place a child in the front passenger seat:

- Your vehicle is equipped with air bag technology designed to deactivate the front passenger front air bag in your vehicle when the system senses the weight of a typical 12-month-old child or less along with the weight of a standard appropriate child restraint on the front passenger seat.
- For children larger than the typical 12-month-old child, the front passenger front air bag may or may not be activated. Always make sure the  indicator lamp is illuminated, indicating that the front passenger front air bag is deactivated.
- A child in a rear-facing child restraint on the front passenger seat will be seriously injured or even killed if the front passenger front air bag inflates in a collision which could occur under some circumstances, even with the air bag technology installed in your vehicle. The only means to completely eliminate this risk is to never place a child in a rear-facing child restraint in the front seat. We therefore strongly recommend that you always place a child in a rear-facing child restraint in a backseat.
- If you must install a rear-facing child restraint on the front passenger seat because circumstances require you to do so, make sure the  indicator lamp is illuminated, indicating that the front

passenger front air bag is deactivated.

Should the  indicator lamp not illuminate or go out while the restraint is installed, please check installation.

Periodically check the  indicator lamp while driving to make sure the  indicator lamp is illuminated. If the

 indicator lamp goes out or remains out, do not transport a child on the front passenger seat until the system has been repaired.

A child in a rear-facing child restraint on the front passenger seat will be seriously injured or even killed if the front passenger front air bag inflates.

- If you have to place a child in a forward-facing child restraint on the front passenger seat, move the seat as far back as possible, use the proper child restraint recommended for the age, size and weight of the child, and secure child restraint with the vehicle's seat belt according to the child seat manufacturer's instructions.

WARNING

Infants and small children should never share a seat belt with another occupant. In the event of an accident, they could be crushed between the occupant and seat belt.

A child's risk of serious or fatal injuries is significantly increased if the child restraints are not properly secured in the vehicle and/or the child is not properly secured in the child restraint.

Children that are too large for a child restraint must travel in seats using normal seat belts. Position the shoulder belt across the chest and shoulder, not face or neck. A booster seat may be necessary to achieve proper seat belt positioning for children over 41 lb (18 kg) until they reach a height where a lap-shoulder belt fits properly without a booster.

When the child restraint is not in use, remove it from the vehicle or secure it with the seat belt to prevent the child restraint from

becoming a projectile in the event of an accident.

WARNING

When leaving the vehicle, always remove the SmartKey from the ignition lock. Always take the SmartKey with you and lock the vehicle. Do not leave children unattended in the vehicle, even if they are secured in a child restraint system, or with access to an unlocked vehicle. A child's unsupervised access to a vehicle could result in an accident and/or serious personal injury. The children could:

- injure themselves on parts of the vehicle
- be seriously or fatally injured through excessive exposure to extreme heat or cold
- injure themselves or cause an accident with vehicle equipment that can be operated even if the SmartKey is removed from the ignition lock or removed from the vehicle, such as seat adjustment, steering wheel adjustment, or the memory function

If children open a door, they could injure other persons or get out of the vehicle and injure themselves or be injured by following traffic.

Do not expose the child restraint system to direct sunlight. The child restraint system's metal parts, for example, could become very hot, and the child could be burned on these parts.

WARNING

Do not carry heavy or hard objects in the passenger compartment or trunk unless they are firmly secured in place.

Unsecured or improperly positioned cargo increases a child's risk of injury in the event of

- strong braking maneuvers
- sudden changes of direction
- an accident

We recommend that all infants and children be properly secured in an infant or child

restraint system at all times while the vehicle is in motion.

The use of seat belts and infant and child restraint systems is required by law in all 50 states, the District of Columbia, the U.S. territories and all Canadian provinces.

Infants and children must always be seated in an appropriate infant or child restraint system recommended for the size and weight of the child. The infant or child restraint system must be properly secured in accordance with the manufacturer's instructions. All infant or child restraint systems must meet Canadian Motor Vehicle Safety Standards 213 and 210.2.

An information label on the child restraint system indicates whether it meets these standards. This information is also provided in the installation instructions supplied with the child restraint system.

Always read and follow the manufacturer's instructions when using an infant or child restraint system or booster seat.

Observe all warning signs in the vehicle interior and on the infant or child restraint.

If an infant or child is traveling in the vehicle:

- ▶ Secure the infant or child with an appropriate infant or child restraint recommended for the child's age and weight.
- ▶ Make sure that the infant or child is properly secured at all times while the vehicle is in motion.

Child seat on the front-passenger seat

WARNING

If the front-passenger air bag is not disabled:

- a child secured in a child restraint system on the front-passenger seat could be seriously or even fatally injured by the front-passenger air bag deploying. This is especially a risk if the child is in the

immediate vicinity of the front-passenger air bag when it deploys.

- never secure a child on the front-passenger seat in a rearward-facing child restraint system. Only secure a rearward-facing child restraint system on a suitable rear seat.
- always move the front-passenger seat to the rearmost position if you secure a child in a forward-facing child restraint system on the front-passenger seat.

The front-passenger air bag is not disabled:

- on vehicles without an air bag deactivation system on the front-passenger seat.
- on vehicles with an air bag deactivation system on the front-passenger seat, unless a child restraint system with transponders for an air bag deactivation system is installed on the front-passenger seat
- on vehicles with an air bag deactivation system on the front-passenger seat, if the PASSENGER AIR BAG OFF indicator lamp  is not lit.

To make you aware of this danger, a corresponding warning sticker has been affixed on the dashboard and on both sides of the sun visor on the front-passenger side.

Information about recommended child restraint systems is available at any authorized Mercedes-Benz Center.



Warning notice on the front-passenger sun visor



Warning symbol for a rearward-facing child restraint system

Do not use a rearward-facing child restraint system on a seat that is protected by an air bag installed in front of it.

Air bag deactivation system on the front-passenger seat

WARNING

If the  PASSENGER AIRBAG OFF indicator lamp does not light up when the child restraint system is installed, the front-passenger air bag has not been disabled. If the front-passenger air bag deploys, the child could be seriously or even fatally injured.

Proceed as follows:

- do not use a rearward-facing child restraint system on the front-passenger seat.
- install a rearward-facing child restraint system on a suitable rear seat.

or

- only use a forward-facing child restraint system on the front-passenger seat and move the front-passenger seat to the rearmost position.
- have the air bag deactivation system checked at a qualified specialist workshop.



To ensure that the air bag deactivation system on the front-passenger seat functions/communicates correctly, never place objects, e.g. a cushion, under the child restraint system. The entire base of the child restraint system must always rest on the seat cushion. An incorrectly installed child restraint system

cannot perform its intended protective function in the event of an accident, and could lead to injuries.



WARNING

Do not place electronic devices on the front-passenger seat, e.g.:

- laptops, when switched on
- mobile phones
- cards with transponders, e.g. ski passes or access cards

Signals from electronic equipment can cause interference in the sensor system of the air bag deactivation system. This can lead to a system malfunction. This may cause the  PASSENGER AIR BAG OFF indicator lamp to light up even if no child seat with a transponder for an air bag deactivation system is installed. The front-passenger air bag would not then deploy during an accident. It is also possible that the  SRS warning lamp lights up and/or the  PASSENGER AIR BAG OFF indicator lamp does not light up briefly when you turn the key in the ignition lock to position **2**.



The sensor system of the air bag deactivation system on the front-passenger seat detects whether a special Mercedes-Benz child seat has been installed there. To support detection by the sensor system, the Mercedes-Benz child seat is equipped with transponders for the air bag deactivation system. In this case, the   

indicator lamp lights up. The front-passenger air bag is deactivated.

i If the front-passenger air bag is deactivated by the air bag deactivation system, the following remain enabled on the front-passenger side:

- the side impact air bag
- the window curtain air bag
- the Emergency Tensioning Device

LATCH-type (ISOFIX) child seat anchors in the rear

WARNING

Children that are too large for a child restraint must travel in seats using normal seat belts. Position the shoulder belt across the chest and shoulder, not face or neck.

A booster seat may be necessary to achieve proper seat belt positioning for children over 41 lb (18 kg) until they reach a height where a lap/shoulder belt fits properly without a booster.

Install the child restraint system in accordance with the manufacturer's instructions.

Attach the child restraint system to both securing rings.

An incorrectly installed child restraint system could come loose during an accident and seriously or even fatally injure the child.

Child restraint systems or child seat securing rings that are malfunctioning or damaged as the result of a collision must be replaced.

! When installing the child restraint system, make sure that the seat belt for the middle seat does not get trapped. The seat belt could otherwise be damaged.

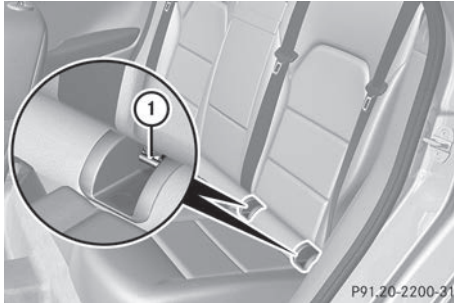

ISOFIX is a standardized securing system for specially designed child restraint systems on the rear seats. ISOFIX securing rings ① for two LATCH-type (ISOFIX) child restraint systems are installed on the left and right of the rear seats.

Secure non-LATCH-type (ISOFIX) child restraint systems using the vehicle's seat belt system. Always install child restraint systems according to the manufacturer's instructions.

- ▶ Install the LATCH-type (ISOFIX) child restraint system. Comply with the manufacturer's instructions when installing the LATCH-type (ISOFIX) child restraint system.

Top Tether

WARNING

If the red display is visible when the rear seat backrest is upright, it means the rear seat backrest is not engaged correctly.

Always engage the rear seat backrests in an upright position if there are passengers in the rear compartment. Engage the rear seat backrests in an upright position after you have installed the Top Tether belt or if the extended cargo compartment is not being used. Push and pull the rear seat backrests to check whether they are engaged correctly. The rear seat backrest may fold down if it is not engaged correctly. The child restraint system is then no longer supported correctly or held in position and can no longer perform its intended function. This can cause serious or even fatal injuries.

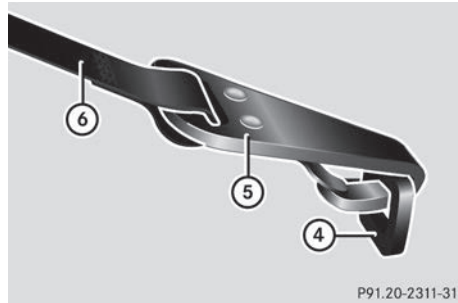
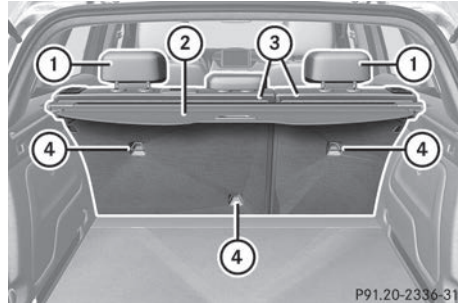

Top Tether provides an additional connection between a child restraint system, secured with a LATCH-type (ISOFIX) child seat mount, and the rear seat. This helps reduce the risk of injury even further.

The Top Tether anchorages are located on the rear side of the rear seat backrests.









- ▶ Move head restraint ① upwards.
- ▶ Release rear seat backrest ③ and fold it forwards (> page 234).
- ▶ Route Top Tether belt ⑥ under head restraint ① between the two head restraint bars.
- ▶ Hook Top Tether hook ⑤ of Top Tether belt ⑥ into Top Tether anchorage ④.

Ensure that:

- Top Tether hook ⑤ is hooked into Top Tether anchorage ④ as shown.
- Top Tether belt ⑥ is not twisted.
- Top Tether belt ⑥ is routed between rear seat backrest ③ and cargo compartment cover ② if cargo compartment cover ② is installed.

- ▶ Swing back rear seat backrest ③ until it engages.
The red lock verification indicator is no longer visible.
- ▶ Move head restraint ① back down again slightly if necessary (▷ page 87). Make sure that you do not interfere with the correct routing of Top Tether belt ⑥.
- ▶ Install the LATCH-type (ISOFIX) child restraint system with Top Tether. Comply with the manufacturer's installation instructions when doing so. Make sure that Top Tether belt ⑥ is tight.

Problems with the air bag deactivation system

Problem	Possible causes/consequences and ► Solutions
<p>The   indicator lamp on the center console is lit.</p>	<p>A special Mercedes-Benz child seat with transponders for an air bag deactivation system has been installed on the front-passenger seat. The front-passenger air bag has therefore been deactivated as desired.</p> <p> WARNING</p> <p>There is no child seat installed on the front-passenger seat. The air bag deactivation system is malfunctioning.</p> <p>It is also possible that the  SRS warning lamp lights up and/or the   indicator lamp does not light up briefly when you switch the ignition on.</p> <p>There is a risk of injury.</p> <p>► Remove electronic equipment from the front-passenger seat, e.g.</p> <ul style="list-style-type: none"> • Laptop • Mobile phone • Cards with transponders, such as ski passes or access cards <p>If the   indicator lamp remains lit:</p> <p>► Visit a qualified specialist workshop.</p>

Suitable positioning of the child restraint systems

Key to the letters used in the table:

- X Seat which is unsuitable for children in this weight category.
- U Suitable for child restraint systems in the Universal category that are approved for use in this weight category.
- UF Suitable for forward-facing child restraint systems that belong to the "Universal" category and are approved for use in this weight category.
- L Suitable for child restraint systems as recommended, see the following table of "Recommended child restraint systems" (▷ page 56).

Weight categories	Seat positions			
	Front-passenger seat		Rear seat	
	The front-passenger air bag is not deactivated	The front-passenger air bag is disabled ¹	Left, right	Center
Category 0: up to 10 kg	X	U ² , L ²	U, L	U, L
Category 0+: up to 13 kg	X	U ² , L ²	U, L	U, L
Category I: 9 to 18 kg	U ² , L ²	U ² , L ²	U, L	U, L
Category II: 15 to 25 kg	U ² , L ²	U ² , L ²	U, L	U, L
Category III: 22 to 36 kg	U ² , L ²	U ² , L ²	U, L	U, L

"Universal" category child restraint systems can be recognized by their orange approval label.

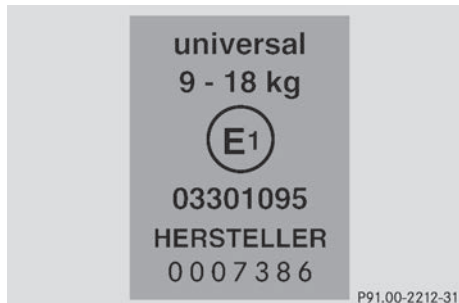

Example: approval label on the child restraint system

Key to the letters used in the table:

- X ISOFIX position that is not suitable for LATCH-type (ISOFIX) child restraint systems in this weight category and/or size category.
- IUF Suitable for forward-facing LATCH-type (ISOFIX) child restraint systems that belong to the "Universal" category which are approved for use in this weight category.
- IL Suitable for LATCH-type (ISOFIX) child restraint systems as recommended; see the following table of "Recommended child restraint systems" (> page 56).

¹ Vehicles with an air bag deactivation system in the front-passenger seat: a child restraint system of the "Universal" category with a transponder for the air bag deactivation system must be installed. The  indicator lamp must light up.

² Move the front-passenger seat to the rearmost and highest position, the backrest to an almost vertical position, and the belt height adjustment to the lowest position.

Suitability of the rear seats for attaching LATCH-type (ISOFIX) child restraint systems

Weight categories	Size category	Equipment	Rear seat, left and right
Carry-cot	F	ISO/L1	X
	G	ISO/L2	X
0: up to 10 kg up to approximately 6 months	E	ISO/R1	IL
0+: up to 13 kg up to approximately 15 months	E	ISO/R1	IL
	D	ISO/R2	IL
	C	ISO/R3	IL
I: 9 to 18 kg between approximately 9 months and 4 years	D	ISO/R2	IL
	C	ISO/R3	IL
	B	ISO/F2	IUF
	B1	ISO/F2X	IUF
	A	ISO/F3	IUF

Recommended child restraint systems

When installing a child restraint system without a transponder for the air bag deactivation system on the front-passenger seat:

- Move the front-passenger seat to its rearmost position.

Weight categories	Manufacturer	Type	Approval number (E1 ...)	Order number (A 000 ...)	Air bag deactivation system
Category 0: up to 10 kg up to approximately 6 months	Britax Römer	BABY SAFE PLUS	03 301146	970 10 00	Yes
			04 301146		
Category 0+: up to 13 kg up to approximately 15 months	Britax Römer	BABY SAFE PLUS	03 301146	970 10 00	Yes
			04 301146		
Category I: 9 to 18 kg	Britax Römer	DUO PLUS	03 301133	970 11 00	Yes
			04 301133		

Weight categories	Manufacturer	Type	Approval number (E1 ...)	Order number (A 000 ...)	Air bag deactivation system
between approximately 9 months and 4 years				970 16 00	No
Category II/III: 15 to 36 kg between approximately 4 and 12 years	Britax Römer	KIDFIX	04 301198	970 18 00	Yes
				970 19 00	No

Suggested LATCH-type (ISOFIX) child restraint system from the Universal/Semi-Universal category

Weight categories	Size category	Manufacturer	Type	Approval number (E1 ...)	Order number	Air bag deactivation system
Carry-cot	F	-	-	-	-	-
	G	-	-	-	-	-
Group 0: up to 10 kg	E	-	-	-	-	-
Group 0+: up to 13 kg	E	Britax Römer	BABY SAFE ISOFIX PLUS	04 301146	B6 6 86 8224	No
	D	-	-	-	-	-
	C	-	-	-	-	-
Group I: 9 to 18 kg	D	-	-	-	-	-
	C	-	-	-	-	-
	B	-	-	-	-	-
	B1	Britax Römer	DUO PLUS	04 301133	A 000 970 11 00	Yes
					A 000 970 16 00	No
A	-	-	-	-	-	

Child-proof locks

Important safety notes

WARNING

When leaving the vehicle, always remove the SmartKey from the ignition lock. Always take the SmartKey with you and lock the vehicle. Do not leave children unattended in the vehicle, even if they are secured in a child restraint system, or with access to an unlocked vehicle. A child's unsupervised access to a vehicle could result in an accident and/or serious personal injury. The children could:

- injure themselves on parts of the vehicle
- be seriously or fatally injured through excessive exposure to extreme heat or cold
- injure themselves or cause an accident with vehicle equipment that can be operated even if the SmartKey is removed from the ignition lock or removed from the vehicle, such as seat adjustment, steering wheel adjustment, or the memory function

If children open a door, they could injure other persons or get out of the vehicle and injure themselves or be injured by following traffic.

Do not expose the child restraint system to direct sunlight. The child restraint system's metal parts, for example, could become very hot, and the child could be burned on these parts.

Child-proof locks for the rear doors

WARNING

Children could open a rear door from inside the vehicle. This could result in serious injuries or an accident. Therefore, when children ride in the rear always secure the rear doors with the child-proof locks.

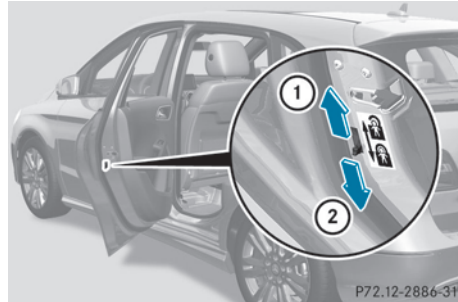

You secure each door individually with the child-proof locks on the rear doors. A door secured with a child-proof lock cannot be opened from inside the vehicle. When the vehicle is unlocked, the door can be opened from the outside.

- ▶ **To activate:** press the child-proof lock lever up in the direction of arrow ①.
- ▶ Make sure that the child-proof locks are working properly.
- ▶ **To deactivate:** press the child-proof lock lever down in the direction of arrow ②.

Override feature for the rear side windows

WARNING

When children ride on the vehicle's rear seats, activate the override switch. Otherwise, the children could be injured, e.g. by trapping themselves in the rear side window.

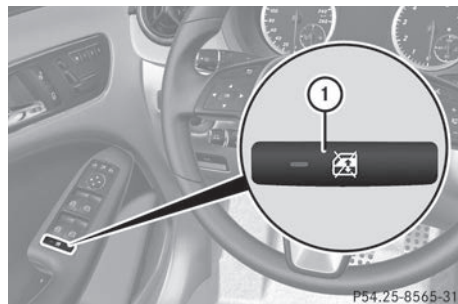

- ▶ **To activate/deactivate:** press button ①. If the indicator lamp is lit, operation of the rear side windows is deactivated.

Operation is only possible using the switches in the driver's door. If the indicator lamp is off, operation is possible using the switches in the rear compartment.

In wintry driving conditions, always use winter tires (M+S tires) and if necessary, snow chains. Only in this way will the driving safety systems described in this section work as effectively as possible.

Driving safety systems

Driving safety systems overview

In this section, you will find information about the following driving safety systems:

- ABS (**A**nti-**l**ock **B**raking **S**ystem)
- BAS (**B**rake **A**ssist **S**ystem)
- COLLISION PREVENTION ASSIST (adaptive Brake Assist and distance warning signal)
- Adaptive brake lamps
- ESP® (**E**lectronic **S**tability **P**rogram)
- EBD (**E**lectronic **B**rake force **D**istribution)
- ADAPTIVE BRAKE (▷ page 64)
- STEER CONTROL

Important safety notes

If you fail to adapt your driving style or become distracted, the driving safety systems can neither reduce the risk of accident nor override the laws of physics. Driving safety systems are merely aids designed to assist driving. You are responsible for the distance to the vehicle in front, for vehicle speed and for braking in good time. Always adapt your driving style to suit the prevailing road, weather and traffic conditions and maintain a safe distance from the vehicle in front. Drive carefully.

- ❗ The driving safety systems described only work as effectively as possible when there is adequate contact between the tires and the road surface. Pay particular attention to the information regarding tires, recommended minimum tire tread depths etc. in the "Wheels and tires" section (▷ page 292).

ABS (Anti-lock Braking System)

Important safety notes

- ❗ Observe the "Important safety notes" section (▷ page 59).

WARNING

If ABS is faulty, the wheels could lock when braking. The steerability and braking characteristics may be severely impaired. Additionally, further driving safety systems are deactivated. There is an increased danger of skidding and accidents.

Drive on carefully. Have ABS checked immediately at a qualified specialist workshop.

When ABS is malfunctioning, other systems, including driving safety systems, will also become inoperative. Observe the information on the ABS warning lamp (▷ page 220) and display messages which may be shown in the instrument cluster (▷ page 194).

ABS regulates brake pressure in such a way that the wheels do not lock when you brake. This allows you to continue steering the vehicle when braking.

ABS works from a speed of about 5 mph (8 km/h) upwards, regardless of road-surface conditions. ABS works on slippery roads, even if you only brake gently.

The yellow  ABS warning lamp in the instrument cluster lights up when the ignition is switched on. It goes out when the engine is running.

Braking

- ▶ **If ABS intervenes:** continue to depress the brake pedal vigorously until the braking situation is over.
- ▶ **To make a full brake application:** depress the brake pedal with full force.

If ABS intervenes when braking, you will feel a pulsing in the brake pedal.

The pulsating brake pedal can be an indication of hazardous road conditions, and functions as a reminder to take extra care while driving.

BAS (Brake Assist System)

- ▶ **i** Observe the "Important safety notes" section (▷ page 59).

WARNING

If BAS is malfunctioning, the braking distance in an emergency braking situation is increased. There is a risk of an accident.

In an emergency braking situation, depress the brake pedal with full force. ABS prevents the wheels from locking.

BAS operates in emergency braking situations. If you depress the brake pedal quickly, BAS automatically boosts the braking force, thus shortening the stopping distance.

The brakes will function as usual once you release the brake pedal. BAS is deactivated.

COLLISION PREVENTION ASSIST

General notes

COLLISION PREVENTION ASSIST consists of the Adaptive Brake Assist and the distance warning function, which are described in the following.

Distance warning function

Important safety notes

- ▶ **i** Observe the "Important safety notes" section (▷ page 59).

WARNING

The distance warning function does not react:

- to people or animals
- to oncoming vehicles
- to crossing traffic
- when cornering

Thus, the distance warning function cannot provide a warning in all critical situations. There is a risk of an accident.

Always pay careful attention to the traffic situation and be ready to brake.

The distance warning function cannot always clearly identify objects and complex traffic situations.



In such cases, the distance warning function may:

- give an unnecessary warning
- not give a warning

Always pay careful attention to the traffic situation and do not rely solely on the distance warning function.

Function

- ▶ **To activate/deactivate:** activate or deactivate the distance warning function in the on-board computer (▷ page 188).

When the distance warning function is activated, the multifunction display shows the  symbol, as long as the HOLD function is not switched on (▷ page 160). On vehicles with Active Parking Assist, the  symbol is displayed when transmission position **P** is selected or if you drive faster than 22 mph (35 km/h).

The distance warning function can help you to minimize the risk of a front-end collision with a vehicle ahead or reduce the effects of such a collision. If the distance warning

function detects that there is a risk of a collision, you will be warned visually and acoustically. The distance warning function cannot prevent a collision without your intervention.

At speeds of approximately 20 mph (30 km/h) or more, the distance warning function warns you if you are rapidly approaching the vehicle in front. An intermittent warning tone will then sound and the  distance warning lamp will light up in the instrument cluster.

► Brake immediately in order to increase the distance from the vehicle in front.

or

► Take evasive action, provided it is safe to do so.

For the distance warning function to assist you when driving, the function must be activated in the on-board computer (▷ page 188) and be operational.

Due to the nature of the system, particularly complicated driving conditions may cause the system to display unnecessary warnings.

With the help of the radar sensor system, the distance warning function can detect obstacles that are in the path of your vehicle for an extended period of time.

At speeds up to 40 mph (70 km/h), the distance warning function may also detect stationary obstacles such as stopped or parked vehicles.

If you approach an obstacle and the distance warning function detects a risk of a collision, the system will initially alert you both visually and acoustically.

In particular, the detection of obstacles can be impaired if there is:

- dirt on the sensors or anything else covering the sensors
- snow or heavy rain
- interference by other radar sources
- the possibility of strong radar reflections, for example in parking garages

- a narrow vehicle traveling in front, e.g. a motorbike
- a vehicle traveling in front on a different line relative to the center of your vehicle

Following damage to the front end of the vehicle, have the configuration and operation of the radar sensor checked at a qualified specialist workshop. This also applies to collisions at low speeds where there is no visible damage to the front of the vehicle.

i Observe the "Important safety notes" section (▷ page 59).

i USA only: This device has been approved by the FCC as a "Vehicular Radar System". The radar sensor is intended for use in an automotive radar system only. Removing, altering or tampering with the device will void any warranties, and is not permitted by the FCC. Do not tamper with, alter, or use the device in any non-approved way. Any unauthorized modification to this device could void the user's authority to operate the equipment.

i Canada only: This device complies with RSS-210 of Industry Canada. Operation is subject to the following two conditions:

1. This device may not cause interference, and
2. this device must accept any interference received, including interference that may cause undesired operation of the device.

Removal, tampering, or altering of the device will void any warranties, and is not permitted. Do not tamper with, alter, or use the device in any non-approved way.

Any unauthorized modification to this device could void the user's authority to operate the equipment.

Adaptive Brake Assist

i Observe the "Important safety notes" section (▷ page 59).

⚠ WARNING

Adaptive Brake Assist cannot always clearly identify objects and complex traffic situations. In these cases, Adaptive Brake Assist may not intervene. There is a risk of an accident.

Always pay careful attention to the traffic situation and be ready to brake.

⚠ WARNING

Adaptive Brake Assist does not react:

- to people or animals
- to oncoming vehicles
- to crossing traffic
- to stationary obstacles
- when cornering

As a result, Adaptive Brake Assist may not intervene in all critical conditions. There is a risk of an accident.

Always pay careful attention to the traffic situation and be ready to brake.

Adaptive Brake Assist provides braking assistance in hazardous situations at speeds greater than 20 mph (30 km/h) and uses radar sensor technology to assess the traffic situation.

With the help of Adaptive Brake Assist, the distance warning signal can detect obstacles that are in the path of your vehicle for an extended period of time.

Should you approach an obstacle and Adaptive Brake Assist has detected a risk of collision, Adaptive Brake Assist calculates the braking force necessary to avoid a rear-end collision. Should you apply the brakes vigorously, Adaptive Brake Assist will automatically increase the braking force to a level suitable for the traffic conditions.

- ▶ Keep the brake pedal depressed until the emergency braking situation is over. ABS prevents the wheels from locking.

The brakes will work normally again if:

- you release the brake pedal.
- there is no longer any danger of a rear-end collision.
- no obstacle is detected in front of your vehicle.

Adaptive Brake Assist is then deactivated.

Up to vehicle speeds of around 155 mph (250 km/h), Adaptive Brake Assist is capable of reacting to moving objects that have already been recognized as such at least once over the period of observation. Adaptive Brake Assist does not react to stationary obstacles.

If Adaptive Brake Assist is not available due to a malfunction in the radar sensor system, the brake system remains available with full brake boosting effect and BAS.

In particular, the detection of obstacles can be impaired if there is:

- dirt on the sensors or anything else covering the sensors
- snow or heavy rain
- interference by other radar sources
- the possibility of strong radar reflections, for example in parking garages
- a narrow vehicle traveling in front, e.g. a motorbike
- a vehicle traveling in front on a different line relative to the center of your vehicle

Following damage to the front end of the vehicle, have the configuration and operation of the radar sensor checked at a qualified specialist workshop. This also applies to collisions at low speeds where there is no visible damage to the front of the vehicle.

i This device has been approved by the FCC as a "Vehicular Radar System". The radar sensor is intended for use in an automotive radar system only. Removing, altering or tampering with the device will void any warranties, and is not permitted by the FCC. Do not tamper with, alter, or use the device in any non-approved way.

Any unauthorized modification to this device could void the user's authority to operate the equipment.

Adaptive brake lamps

If you brake sharply from a speed of more than 50 km/h or if braking is assisted by BAS or Adaptive Brake Assist, the brake lamps flash rapidly. In this way, traffic traveling behind you is warned in an even more noticeable manner.

If you brake sharply to a standstill from a speed of more than 70 km/h, the hazard warning lamps are activated automatically. If the brakes are applied again, the brake lamps light up continuously. The hazard warning lamps switch off automatically if you travel faster than 10 km/h. You can also switch off the hazard warning lamps using the hazard warning button (▷ page 99).

- i** Adaptive brake lamps are only available in certain countries.

ESP® (Electronic Stability Program)

Important safety notes

- i** Observe the "Important safety notes" section (▷ page 59).

WARNING



If ESP® is malfunctioning, ESP® is unable to stabilize the vehicle. Additionally, further driving safety systems are deactivated. This increases the risk of skidding and an accident.

Drive on carefully. Have ESP® checked at a qualified specialist workshop.

- !** When testing the electric parking brake on a braking dynamometer, switch off the ignition. Application of the brakes by ESP® may otherwise destroy the brake system.

When towing your vehicle with the front axle raised, pay attention to the notes about ESP® (▷ page 286).

ESP® is deactivated if the  warning lamp in the instrument cluster lights up continuously when the engine is running.

If the  warning lamp and the  warning lamp are lit continuously, ESP® is not available due to a malfunction.

Observe the information on warning lamps (▷ page 222) and display messages which may be shown in the instrument cluster (▷ page 194).

If ESP® detects that the vehicle is deviating from the direction desired by the driver, one or more wheels are braked to stabilize the vehicle. The engine output is also modified to keep the vehicle on the desired course within physical limits. ESP® assists the driver when pulling away on wet or slippery roads. ESP® can also stabilize the vehicle during braking.

If ESP® intervenes, the  ESP® warning lamp flashes in the instrument cluster.

If ESP® intervenes:

- ▶ Do not deactivate ESP® under any circumstances.
- ▶ Only depress the accelerator pedal as far as necessary when pulling away.
- ▶ Adapt your driving style to suit the prevailing road and weather conditions.

- i** Only use wheels with the recommended tire sizes. Only then will ESP® function properly.

ETS (Electronic Traction System)

- i** Observe the "Important safety notes" section (▷ page 59).

Traction control is part of ESP®.

Traction control brakes the drive wheels individually if they spin. This enables you to pull away and accelerate on slippery surfaces, for example if the road surface is slippery on one side.

Traction control remains active if you deactivate ESP®.

Deactivating/activating ESP®

i Observe the "Important safety notes" section (▷ page 59).

WARNING

If you deactivate ESP®, ESP® no longer stabilizes the vehicle. There is an increased risk of skidding and an accident.

Only deactivate ESP® in the situations described in the following.

! Avoid spinning the driven wheels for an extended period with ESP® deactivated. You could otherwise damage the drivetrain.

ESP® is activated automatically when the engine is started.

If ESP® is deactivated and one or more wheels start to spin, the  ESP® warning lamp in the instrument cluster flashes. In such situations, ESP® will not stabilize the vehicle.

▶ **To deactivate:** (▷ page 187).

The  ESP® OFF warning lamp in the instrument cluster lights up.

▶ **To activate:** (▷ page 187).

The  ESP® OFF warning lamp in the instrument cluster goes out.

It may be best to deactivate ESP® in the following situations:

- when using snow chains
- in deep snow
- on sand or gravel

If you deactivate ESP®:

- ESP® no longer improves driving stability.
- traction control is still activated.
- ESP® still provides support when you brake.
- the engine's torque is no longer limited and the drive wheels can spin. The spinning of the wheels results in a cutting action, which provides better grip.

EBD (electronic brake force distribution)

i Observe the "Important safety notes" section (▷ page 59).

WARNING

If EBD has malfunctioned, the rear wheels can still lock, e.g. under full braking. This increases the risk of skidding and an accident.

You should therefore adapt your driving style to the different handling characteristics. Have the brake system checked at a qualified specialist workshop.

Observe information regarding indicator and warning lamps (▷ page 220) as well as display messages (▷ page 196).

EBD monitors and controls the brake pressure on the rear wheels to improve driving stability while braking.

ADAPTIVE BRAKE

ADAPTIVE BRAKE enhances braking safety and offers increased braking comfort. In addition to the braking function, ADAPTIVE BRAKE also has the HOLD function (▷ page 160) and hill start assist (▷ page 128). For further information, see Driving tips (▷ page 146).

STEER CONTROL

STEER CONTROL helps you by transmitting a noticeable steering force to the steering wheel in the direction required for vehicle stabilization.

This steering assistance is provided in particular if:

- both right wheels or both left wheels are on a wet or slippery road surface when you brake
- the vehicle starts to skid

If ESP® is malfunctioning, you will not receive steering support from STEER CONTROL.

Power steering will, however, continue to function.

Theft deterrent locking system

Immobilizer

The immobilizer prevents your vehicle from being started without the correct SmartKey.

- ▶ **To activate:** remove the SmartKey from the ignition lock.
- ▶ **To deactivate:** switch on the ignition.

When leaving the vehicle, always take the SmartKey with you and lock the vehicle. The engine can be started by anyone with a valid SmartKey that is left inside the vehicle.

i The immobilizer is always deactivated when you start the engine.

In the event that the engine cannot be started when the starter battery is fully charged, the immobilizer may be faulty. Contact an authorized Mercedes-Benz Center or call 1-800-FOR-MERCEDES (in the USA) or 1-800-387-0100 (in Canada).

In the event that the engine cannot be started when the starter battery is fully charged, the immobilizer may be faulty. Contact an authorized Mercedes-Benz Center or call 1-800-387-0100.

ATA (anti-theft alarm system)

Function

A visual and audible alarm is triggered if the alarm system is armed and you open:

- a door
- the vehicle with the mechanical key
- the tailgate
- the hood

The alarm is not switched off, even if you close the open door that has triggered it, for example.

i If the alarm stays on for more than 30 seconds, the Tele Aid system automatically initiates a call to the Customer Assistance center. The Tele Aid system will initiate the call provided that:

- you have subscribed to the Tele Aid service.
- the Tele Aid service has been activated properly.
- the required mobile phone, power supply and GPS are available.

Safety

Activating





- ▶ Lock the vehicle with the SmartKey. Indicator lamp ① flashes. The alarm system is armed after approximately 15 seconds.

Deactivating

- ▶ Unlock the vehicle with the SmartKey.
- or
- ▶ Insert the SmartKey into the ignition lock.

Turning off the alarm

- ▶ Insert the SmartKey into the ignition lock. The alarm turns off.
- or
- ▶ Press the  or  button on the SmartKey. The alarm turns off.

Interior motion sensor

Function

When the interior motion sensor is armed, a visual and audible alarm is triggered if movement is detected in the vehicle interior. This occurs if someone reaches into the vehicle interior, for example.

Activating

- ▶ Make sure that:
 - the side windows are closed.
 - the panorama roof with power tilt/sliding panel is closed.
 This will prevent false alarms.
- ▶ Make sure that the doors and tailgate are closed.
Only then is the interior motion sensor armed.
- ▶ Lock the vehicle with the SmartKey.
The interior motion sensor is armed after approximately 30 seconds.

Deactivating

- ▶ Unlock the vehicle with the SmartKey.
- or
- ▶ Insert the SmartKey into the ignition lock.
The interior motion sensor is disarmed automatically.

Deactivating

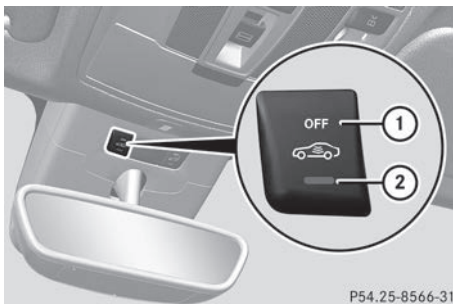

P54.25-8566-31

- ▶ Remove the SmartKey from the ignition lock.
- ▶ Press button ①.
Indicator lamp ② flashes briefly.
- ▶ Lock the vehicle with the SmartKey.
The interior motion sensor is deactivated.

The interior motion sensor remains deactivated until:

- the vehicle is unlocked again.
- a door is opened and closed again.
- the vehicle is locked again.

To prevent a false alarm, deactivate the interior motion sensor if you lock your vehicle and:

- people or animals remain in the vehicle.
- the side windows remain open.
- the panorama roof with power tilt/sliding panel remains open.

Useful information	68
SmartKey	68
Doors	73
Cargo compartment	76
Side windows	77
Sliding sunroof	80

Useful information

- i** This Operator's Manual describes all models and all standard and optional equipment of your vehicle available at the time of publication of the Operator's Manual. Country-specific differences are possible. Please note that your vehicle may not be equipped with all features described. This also applies to safety-related systems and functions.
- i** Please read the information on qualified specialist workshops (▷ page 23).

SmartKey

Important safety notes

WARNING

When leaving the vehicle, always remove the SmartKey from the ignition lock. Always take the SmartKey with you and lock the vehicle. Do not leave children unsupervised in the vehicle, even if they are secured in a child restraint system, and do not give them access to an unlocked vehicle. A child's unsupervised access to a vehicle could result in an accident and/or serious personal injury. They could:

- injure themselves on vehicle parts
- be seriously or fatally injured by extreme heat or cold
- injure themselves or have an accident with vehicle equipment that may still be in operation even after the SmartKey has been removed from the ignition, such as the seat adjustment, steering wheel adjustment or memory function.

If children open a door, they could cause severe or even fatal injury to other persons; if they get out of the vehicle, they could injure themselves when doing so or be seriously or even fatally injured by any passing traffic.

Do not expose the child restraint system to direct sunlight. The child restraint system's metal parts, for example, could become very

hot, and a child could be burned on these parts.

WARNING

Do not attach any heavy or large key rings to the key that is inserted in the ignition. If a key ring is too heavy or too large, the weight acting on the key could cause it to turn in the ignition lock or catch on the steering wheel. This could cause the engine to be switched off suddenly. You could lose control of the vehicle and cause an accident.

Keep the SmartKey away from strong magnetic fields. Otherwise, the remote control function could be affected.



Do not keep the SmartKey:

- with electronic devices, e.g. a mobile phone or another SmartKey
- with metallic objects, e.g. coins or metal foil
- inside metallic objects, e.g. a metal case

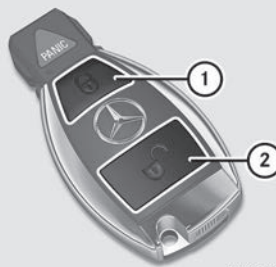
SmartKey functions



P80.35-2458-31

- ①  To lock the vehicle
- ②  To unlock the vehicle

► **To unlock centrally:** press the  button.

If you do not open the vehicle within approximately 40 seconds of unlocking:

- the vehicle is locked again.
- the theft deterrent locking system is armed again.

► **To lock centrally:** press the  button.

The SmartKey centrally locks/unlocks:

- the doors
- the tailgate
- the fuel filler flap



When unlocking, the turn signals flash once. When locking, they flash three times.



When it is dark, the surround lighting also comes on if it is activated in the on-board computer (> page 190).

You can also set an audible signal to confirm that the vehicle has been locked. The audible signal can be activated and deactivated using the on-board computer (> page 191).

Changing the settings of the locking system

You can change the settings of the locking system. When you then unlock the vehicle only the driver's door and the fuel filler flap are unlocked. This is useful if you frequently travel on your own.

► **To change the setting:** press and hold down the  and  buttons simultaneously for approximately six seconds until the battery check lamp (> page 70) flashes twice.

i If the setting of the locking system is changed within the signal range of the vehicle, pressing the  or  button:



- locks or
- unlocks the vehicle

The SmartKey now functions as follows:

► **To unlock the driver's door:** press the  button once.

► **To unlock centrally:** press the  button twice.

► **To lock centrally:** press the  button.

► **To restore the factory settings:** press and hold down the  and  buttons simultaneously for approximately six

seconds until the battery check lamp flashes twice (> page 70).



Mechanical key

General notes

If the vehicle can no longer be unlocked with the SmartKey, use the mechanical key.

If you use the mechanical key to unlock and open the driver's door, the anti-theft alarm system will be triggered (> page 65).

There are several ways to turn off the alarm:

► Press the  or  button on the SmartKey.

or

► Insert the SmartKey into the ignition lock.

If you unlock the vehicle using the mechanical key, the fuel filler flap will not be unlocked automatically.

► **To unlock the fuel filler flap:** insert the SmartKey into the ignition lock.

Removing the mechanical key

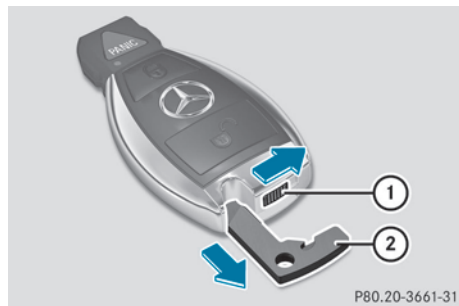

► Push release catch **①** in the direction of the arrow and at the same time remove mechanical key **②** from the SmartKey.

SmartKey battery

Important safety notes

WARNING

Batteries contain toxic and caustic substances. For this reason, keep batteries out of the reach of children.

If a battery has been swallowed, seek medical help immediately.



WARNING



The SmartKey batteries contain perchlorate material, which may require special handling and regard for the environment. Observe government disposal guidelines. California residents, see www.dtsc.ca.gov/HazardousWaste/Perchlorate/index.cfm.

Mercedes-Benz recommends that you have the batteries replaced at a qualified specialist workshop.

Checking the battery



- ▶ Press the  or  button.
The battery is working properly if battery check lamp (1) lights up briefly.
The battery is discharged if battery check lamp (1) does not light up briefly.
- ▶ Change the battery (▷ page 70).

- i** If the SmartKey battery is checked within the signal reception range of the vehicle, pressing the  or  button:
 - locks or
 - unlocks the vehicle

- i** You can get a battery in any qualified specialist workshop.

Replacing the battery

You require a CR 2025 3 V cell battery.

- ▶ Take the mechanical key out of the SmartKey (▷ page 69).

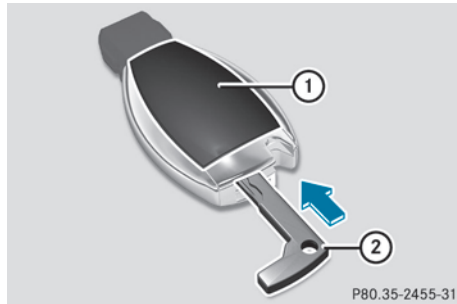



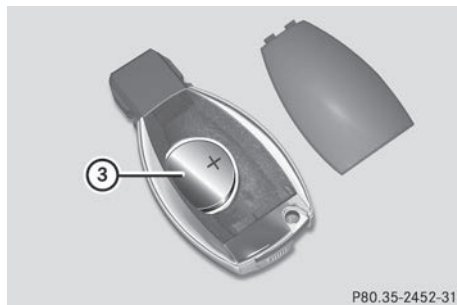

- ▶ Press mechanical key (2) into the opening in the SmartKey in the direction of the arrow until battery tray cover (1) opens. When doing so, do not hold cover (1) shut.
- ▶ Remove battery tray cover (1).



- ▶ Repeatedly tap the SmartKey against your palm until battery (3) falls out.
- ▶ Insert the new battery with the positive terminal facing upwards. Use a lint-free cloth to do so.

- ▶ Make sure that the surface of the battery is free from lint, grease and all other forms of contamination.
- ▶ Insert the front tabs of battery tray cover ① and then press to close it.
- ▶ Insert the mechanical key into the SmartKey.
- ▶ Check the function of all SmartKey buttons on the vehicle.

Problems with the SmartKey

Problem	Possible causes/consequences and ► Solutions
<p>You cannot lock or unlock the vehicle using the SmartKey.</p>	<p>The SmartKey battery is discharged or nearly discharged.</p> <ul style="list-style-type: none"> ► Try again to lock/unlock the vehicle using the remote control function of the SmartKey. Point the tip of the SmartKey at the driver's door handle from close range and press the  or  button. <p>If this does not work:</p> <ul style="list-style-type: none"> ► Check the SmartKey battery and replace it if necessary (▷ page 70). ► Unlock (▷ page 75) or lock (▷ page 75) the vehicle using the mechanical key. <p>There is interference from a powerful source of radio waves.</p> <ul style="list-style-type: none"> ► Try again to lock/unlock the vehicle using the remote control function of the SmartKey. Point the tip of the SmartKey at the driver's door handle from close range and press the  /  button. <p>The SmartKey is faulty.</p> <ul style="list-style-type: none"> ► Unlock (▷ page 75) or lock (▷ page 75) the vehicle using the mechanical key. ► Have the SmartKey checked at a qualified specialist workshop.
<p>You have lost a SmartKey.</p>	<ul style="list-style-type: none"> ► Have the SmartKey deactivated at a qualified specialist workshop. ► Report the loss immediately to the vehicle insurers. ► If necessary, have the locks changed as well.
<p>You have lost the mechanical key.</p>	<ul style="list-style-type: none"> ► Report the loss immediately to the vehicle insurers. ► If necessary, have the locks changed as well.

Problem	Possible causes/consequences and ► Solutions
The engine cannot be started using the SmartKey.	<p>The on-board voltage is too low.</p> <ul style="list-style-type: none"> ► Switch off non-essential consumers, e.g. seat heating or interior lighting, and try to start the engine again. <p>If this does not work:</p> <ul style="list-style-type: none"> ► Check the starter battery and charge it if necessary (► page 279). <p>or</p> <ul style="list-style-type: none"> ► Jump-start the vehicle (► page 283). <p>or</p> <ul style="list-style-type: none"> ► Consult a qualified specialist workshop.
The engine cannot be started using the SmartKey.	<p>The steering lock is mechanically blocked.</p> <ul style="list-style-type: none"> ► Remove the SmartKey and reinsert it into the ignition lock. While doing this, turn the steering wheel in both directions.

Doors

Important safety notes

WARNING

When leaving the vehicle, always remove the SmartKey from the ignition lock. Always take the SmartKey with you and lock the vehicle.

Do not leave children unsupervised in the vehicle, even if they are secured in a child restraint system, and do not give them access to an unlocked vehicle. A child's unsupervised access to a vehicle could result in an accident and/or serious personal injury. They could:

- injure themselves on vehicle parts
- be seriously or fatally injured by extreme heat or cold
- injure themselves or have an accident with vehicle equipment that may still be in operation even after the SmartKey has been removed from the ignition, such as the seat adjustment, steering wheel adjustment or memory function.

If children open a door, they could cause severe or even fatal injury to other persons; if they get out of the vehicle, they could injure

themselves when doing so or be seriously or even fatally injured by any passing traffic.

Do not expose the child restraint system to direct sunlight. The child restraint system's metal parts, for example, could become very hot, and a child could be burned on these parts.

WARNING

Do not carry heavy or hard objects in the passenger compartment or cargo compartment unless they are firmly secured in place.

Unsecured or improperly positioned cargo increases a child's risk of injury in the event of

- strong braking maneuvers
- sudden changes of direction
- an accident

Unlocking and opening doors from the inside

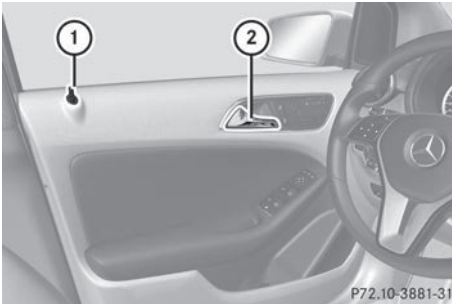

- ▶ Pull door handle (2).
If the door is locked, locking knob (1) pops up. The door is unlocked and can be opened.

You can open a door from inside the vehicle even if it has been locked. You can open the rear doors from inside the vehicle unless they are secured by the child-proof lock (▷ page 58).

If the vehicle has previously been locked with the SmartKey, opening a door from the inside will trigger the anti-theft alarm system. Switch off the alarm (▷ page 65).

Centrally locking and unlocking the vehicle from the inside

You can centrally lock or unlock the vehicle from the inside. This can be useful if you wish to lock the vehicle before pulling away, for example.

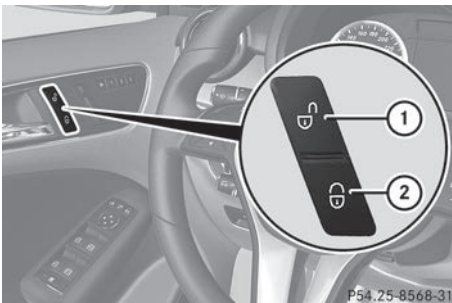

- ▶ **To unlock:** press button (1).

- ▶ **To lock:** press button (2).

If all the doors and the tailgate are closed, the vehicle locks.

Meanwhile, the fuel filler flap will not be locked or unlocked.

You cannot unlock the vehicle centrally from the inside if the vehicle has been locked with the SmartKey.

You can open a door from inside the vehicle even if it has been locked. You can open the rear doors from inside the vehicle unless they are secured by the child-proof lock (▷ page 58).

If the vehicle has previously been locked with the SmartKey, opening a door from the inside will trigger the anti-theft alarm system. Switch off the alarm (▷ page 65).

If the vehicle has been locked using the locking button for the central locking, or has been locked automatically, and a door is opened from the inside:

- the vehicle will be fully unlocked if it had previously been fully unlocked
- only the door which has been opened from the inside is unlocked if only the driver's door had been previously unlocked

Automatic locking feature

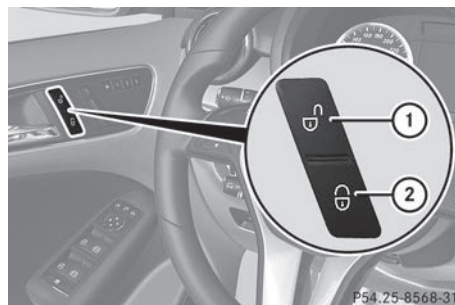

- ▶ **To deactivate:** press and hold button (1) for about five seconds until a tone sounds.

- ▶ **To activate:** press and hold button (2) for about five seconds until a tone sounds.

- i** If you press one of the two buttons and do not hear a tone, the relevant setting has already been selected.

The vehicle is locked automatically when the ignition is switched on and the wheels are turning.

You could therefore lock yourself out if:

- the vehicle is being pushed.
- the vehicle is being towed.
- the vehicle is on a roller dynamometer.

You can also switch the automatic locking function on and off using the on-board computer (▷ page 191).

Unlocking the driver's door (mechanical key)

If the vehicle can no longer be unlocked with the SmartKey, use the mechanical key.

If you use the mechanical key to unlock and open the driver's door, the anti-theft alarm system will be triggered (▷ page 65).

- ▶ Take the mechanical key out of the SmartKey (▷ page 69).
- ▶ Insert the mechanical key into the lock of the driver's door as far as it will go.

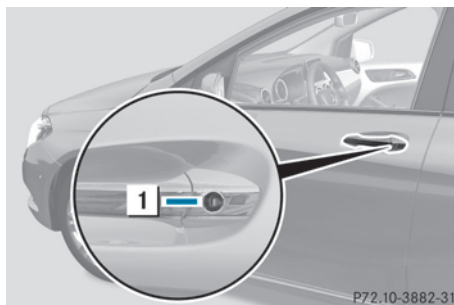

- ▶ Turn the mechanical key counter-clockwise to position **1**.
The door is unlocked.
- ▶ Turn the mechanical key back and remove it.
- ▶ Insert the mechanical key into the SmartKey.

Locking the vehicle (mechanical key)

If the vehicle can no longer be locked with the SmartKey, use the mechanical key.

- ▶ Open the driver's door.
- ▶ Close the front-passenger door, the rear doors and the tailgate.
- ▶ Press the locking button (▷ page 74).
- ▶ Check whether the locking knobs on the front-passenger door and the rear doors are still visible. Press down the locking knobs manually, if necessary (▷ page 74).
- ▶ Close the driver's door.
- ▶ Take the mechanical key out of the SmartKey (▷ page 69).
- ▶ Insert the mechanical key into the lock of the driver's door as far as it will go.

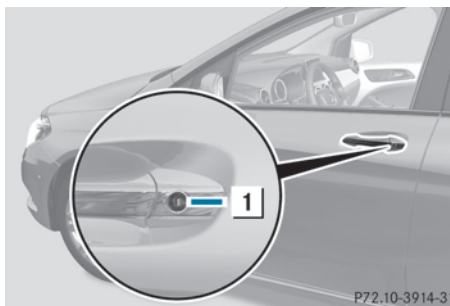

- ▶ Turn the mechanical key clockwise as far as it will go to position **1**.
- ▶ Turn the mechanical key back and remove it.
- ▶ Make sure that the doors and the tailgate are locked.
- ▶ Insert the mechanical key into the SmartKey.

- i** If you lock the vehicle as described above, the fuel filler flap is not locked. The anti-theft alarm system is not armed.

Cargo compartment

Important safety notes

WARNING

When leaving the vehicle, always remove the SmartKey from the ignition lock. Always take the SmartKey with you and lock the vehicle. Do not leave children unsupervised in the vehicle, even if they are secured in a child restraint system, and do not give them access to an unlocked vehicle. A child's unsupervised access to a vehicle could result in an accident and/or serious personal injury. They could:

- injure themselves on vehicle parts
- be seriously or fatally injured by extreme heat or cold
- injure themselves or have an accident with vehicle equipment that may still be in operation even after the SmartKey has been removed from the ignition, such as the seat adjustment, steering wheel adjustment or memory function.

If children open a door, they could cause severe or even fatal injury to other persons; if they get out of the vehicle, they could injure themselves when doing so or be seriously or even fatally injured by any passing traffic.

Do not expose the child restraint system to direct sunlight. The child restraint system's metal parts, for example, could become very hot, and a child could be burned on these parts.

WARNING

Do not carry heavy or hard objects in the passenger compartment or cargo compartment unless they are firmly secured in place.

Unsecured or improperly positioned cargo increases a child's risk of injury in the event of

- strong braking maneuvers
- sudden changes of direction
- an accident

WARNING

Make sure the tailgate is closed when the engine is running and while driving. Among other dangers, deadly carbon monoxide (CO) gases may enter vehicle interior resulting in unconsciousness and death.

 The tailgate swings upwards and to the rear when opened. Therefore, make sure that there is sufficient clearance above and behind the tailgate.

 The opening dimensions of the tailgate can be found in the "Vehicle data" section (▷ page 329).

Do not leave the SmartKey in the cargo compartment. You could otherwise lock yourself out.

The tailgate can be:

- opened and closed manually from outside
- unlocked from inside with the mechanical key

Opening/closing from outside

Opening

▶ Press the  button on the SmartKey.





- ▶ Pull handle ①.
- ▶ Raise the tailgate.

Closing

WARNING

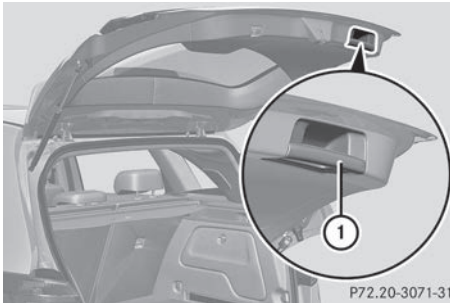
To prevent possible personal injury, always keep hands and fingers away from the cargo compartment opening when closing the tailgate. Be especially careful when small children are around.



- ▶ Pull the tailgate down using handle ①.
- ▶ Allow the tailgate to drop into the lock.
- ▶ If necessary, lock the vehicle with the  button on the SmartKey.

Tailgate emergency release

If the tailgate can no longer be opened from outside the vehicle, use the emergency release on the inside of the tailgate.

- ❗ The tailgate swings upwards and to the rear when opened. Therefore, make sure that there is sufficient clearance above and behind the tailgate.
- i** The opening dimensions of the tailgate can be found in the "Vehicle data" section (▷ page 329).
- ▶ Take the mechanical key out of the SmartKey (▷ page 69).

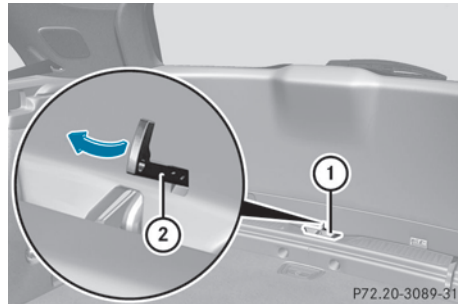

- ▶ Insert mechanical key ② into the opening in paneling ①.
- ▶ Turn mechanical key ② 90° clockwise.
- ▶ Push mechanical key ② in the direction of the arrow and open the tailgate.

Side windows

Important safety notes

WARNING

When opening and closing the side windows, make sure that nobody can be injured by the opening or closing procedure.

The side windows are equipped with automatic operation and the anti-entrapment feature. If in automatic operation a side window encounters an obstruction that blocks its path, the anti-entrapment feature will stop the side window and reopen it slightly.

The side windows operate differently when the switch is pulled. Details can be found under "Problems with the side windows" in this section.

The closing of the side windows can be immediately halted by releasing the switch or, if the switch was pulled past the resistance point and released, by either pressing or pulling the respective switch.

If a side window encounters an obstruction that blocks its path when you are closing the side windows by pressing and holding the

 button on the SmartKey, the anti-entrapment feature will not operate.

Opening and closing the side windows

The switches for all side windows are located on the driver's door. There is also a switch on each door for the corresponding side window.

The switches on the driver's door take precedence.

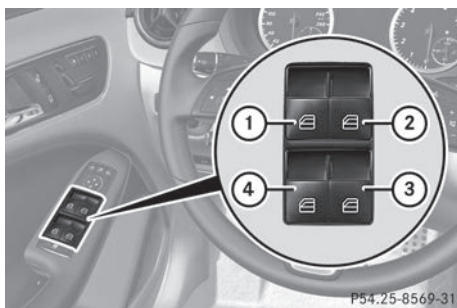

- ① Front left
- ② Front right
- ③ Rear right
- ④ Rear left

i When the override feature for the side windows is activated (> page 58), the side windows cannot be operated from the rear.

▶ Turn the SmartKey to position **1** or **2** in the ignition lock.

▶ **To open:** press the corresponding switch.

▶ **To close:** pull the corresponding switch.

i If you press the switch beyond the point of resistance, an automatic opening/closing process is started in the corresponding direction. You can stop automatic operation by operating the switch again.

i You can continue to operate the side windows after you switch off the engine or remove the SmartKey. This function is available for up to five minutes or until the driver's or front-passenger door is opened.

Convenience opening

You can ventilate the vehicle before you start driving. To do this, the SmartKey is used to carry out the following functions simultaneously:

- unlock the vehicle
- open the side windows
- open the panorama roof with power tilt/sliding panel and the roller sunblinds

i The convenience opening feature can only be operated using the SmartKey. The SmartKey must be close to the driver's door handle.

▶ Point the tip of the SmartKey at the driver's door handle.

▶ Press and hold the  button until the side windows and the panorama roof with power tilt/sliding panel are in the desired position.

If the roller sunblinds of the panorama roof with power tilt/sliding panel are closed, the roller sunblinds are opened first.



▶ Press and hold the  button again until the panorama roof with power tilt/sliding panel is in the desired position.

▶ **To interrupt convenience opening:** release the  button.

Convenience closing

WARNING

When using the convenience closing feature, make sure that nobody can become trapped.

- release the  button.
- press and hold the  button until the side windows and the panorama sliding sunroof open again.



When you lock the vehicle, you can simultaneously:

- close the side windows
- close the panorama roof with power tilt/sliding panel

On vehicles with a panorama roof with power tilt/sliding panel, you can then close the roller sunblinds.

- i** The SmartKey must be close to the driver's door handle.
- ▶ Point the tip of the SmartKey at the driver's door handle.
- ▶ Press and hold the  button until the side windows and the panorama roof with power tilt/sliding panel are fully closed.
- ▶ Make sure that all the side windows and the panorama roof with power tilt/sliding panel are closed.

On vehicles with a panorama roof with power tilt/sliding panel:

- ▶ Press and hold the  button again until the roller sunblinds of the panorama roof with power tilt/sliding panel close.
- ▶ **To interrupt convenience closing:** release the  button.

Resetting the side windows

You must reset each side window if:

- the side window opens again slightly after being closed fully.
- the side window can no longer be fully opened or closed.
- ▶ Close all the doors.
- ▶ Turn the SmartKey to position **1** or **2** in the ignition lock.
- ▶ Pull the corresponding switch on the door control panel until the side window is completely closed (▷ page 78).
- ▶ Hold the switch for an additional second.

If the side window opens again slightly:

- ▶ Immediately pull the corresponding switch on the door control panel until the side window is completely closed (▷ page 78).
- ▶ Hold the switch for an additional second.
- ▶ If the corresponding side window remains closed after the button has been released,

the side window has been reset correctly. If this is not the case, repeat the steps above again.

Problems with the side windows

WARNING

Closing the side windows with increased force or without the anti-entrapment feature could lead to serious or even fatal injury. Make sure that nobody can become trapped when closing the side windows.

WARNING

Pulling and holding the switch to close the door window immediately after it had been blocked two times will cause the door window to close without the anti-entrapment feature for as long as you hold the switch.

Problem: a side window cannot be closed because it is blocked by objects, e.g. leaves in the window guide.

- ▶ Remove the objects.
- ▶ Close the side window.

Problem: a side window cannot be closed and you cannot see the cause. If a side window is obstructed during closing and reopens again slightly:

- ▶ Immediately after the window blocks, pull the corresponding switch again until the side window has closed.
The side window is closed with increased force.

If a side window is obstructed again during closing and reopens again slightly:

- ▶ Immediately after the window blocks, pull the corresponding switch again until the side window has closed.
The side window is closed without the anti-entrapment feature.

Sliding sunroof

Important safety notes

In the following section, the term "sliding sunroof" refers to the panorama roof with power tilt/sliding panel.

WARNING

When opening or closing the sliding sunroof, make sure that there is no danger of anyone being harmed by the opening/closing procedure.

The sliding sunroof is equipped with automatic operation and the anti-entrapment feature. If the movement of the sliding sunroof is blocked during the closing procedure, the sliding sunroof will stop and open slightly.

The sliding sunroof operates differently when the sliding sunroof switch is pressed and held. See the "Problems with the sliding sunroof" section for more details.

The opening/closing procedure of the sliding sunroof can be immediately halted by releasing the sliding sunroof switch or, if the sliding sunroof switch was moved past the resistance point and released, by moving the sliding sunroof switch in any direction.

WARNING

The sliding sunroof is made out of glass. In the event of an accident, the glass may shatter. This may result in an opening in the roof.

In a vehicle rollover, occupants not wearing their seat belts or not wearing them properly may be thrown out of the opening. Such an opening also presents a potential for injury for occupants wearing their seat belts properly, as entire body parts or portions of them may protrude from the passenger compartment.

! Only open the sliding sunroof if it is free of snow and ice. Otherwise, malfunctions may occur.

Do not allow anything to protrude from the sliding sunroof. Otherwise, the seals could be damaged.

! The weather can change abruptly. It could start to rain or snow. Make sure that the sliding sunroof is closed when you leave the vehicle. The vehicle electronics can be damaged if water enters the vehicle interior.

i Resonance noises can occur in addition to the usual airflow noises when the sliding sunroof is open. They are caused by minor pressure fluctuations in the vehicle interior. Change the position of the sliding sunroof or open a side window slightly to reduce or eliminate these noises.

Operating the panorama roof with power tilt/sliding panel

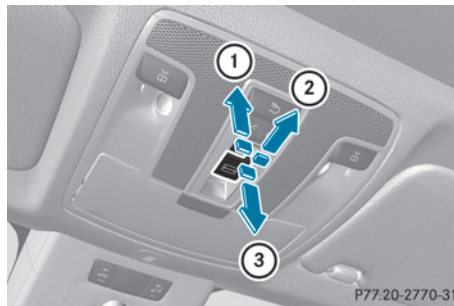

Overhead control panel

- ① To raise
- ② To open
- ③ To close/lower

- ▶ Turn the SmartKey to position **1** or **2** in the ignition lock.
- ▶ Make sure that the roller sunblinds are open.
- ▶ Press or pull the  switch in the corresponding direction.

i If you press the  switch beyond the point of resistance, an automatic opening/closing process is started in the corresponding direction. You can stop automatic operation by operating the switch again.

The automatic raising feature is available only when the panorama roof with power tilt/sliding panel is closed.

- i** You can continue to operate the panorama roof with power tilt/sliding panel after switching off the engine or removing the SmartKey. This function remains active for five minutes or until you open a front door.

Operating the roller sunblinds for the panorama roof with power tilt/sliding panel

Important safety notes

WARNING

When opening or closing the roller sunblinds, make sure that no one can be injured.

The roller sunblinds have automatic operation and an anti-entrapment feature. If the roller sunblinds are blocked during the closing procedure, the anti-entrapment feature stops the roller sunblinds and they open again slightly.

The opening and closing of the roller sunblinds can be terminated immediately by releasing the button. In automatic operation, press the button briefly in any direction to stop the roller sunblinds.

The roller sunblinds shield the vehicle interior from sunlight. The two roller sunblinds can only be opened and closed together when the panorama roof with power tilt/sliding panel is closed.

Opening/closing

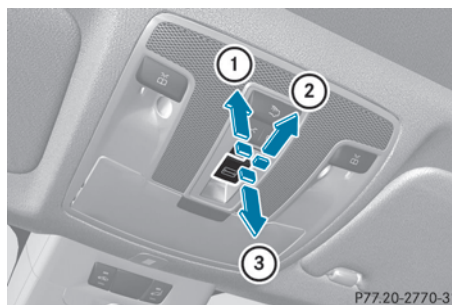

Overhead control panel

- ① To open
- ② To open
- ③ To close

► Turn the SmartKey to position **1** or **2** in the ignition lock.

► Press or pull the  switch in the corresponding direction.

- i** If you press the  switch beyond the point of resistance, an automatic opening/closing process is started in the corresponding direction. You can stop automatic operation by operating the switch again.





Resetting the panorama roof with power tilt/sliding panel and the roller sunblinds

- !** If the panorama roof with power tilt/sliding panel and the roller sunblinds cannot be fully opened or closed after resetting, contact a qualified specialist workshop.

If the panorama roof with power tilt/sliding panel or the front roller sunblinds do not move smoothly, reset the panorama roof with power tilt/sliding panel and the roller sunblinds:

- Turn the SmartKey to position **1** or **2** in the ignition lock.
- Press the  switch to the point of resistance in the direction of arrow **②** and

hold it until the panorama roof with power tilt/sliding panel has opened about 4 in(10 cm).

- ▶ Pull the  switch repeatedly to the point of resistance in the direction of arrow ③ until the panorama roof with power tilt/sliding panel is fully closed.
- ▶ Keep the  switch pulled for an additional second.
- ▶ Press the  switch to the point of resistance in the direction of arrow ② and hold it until the roller sunblinds have opened about 4 in(10 cm).
- ▶ Pull the  switch repeatedly to the point of resistance in the direction of arrow ③ until the roller sunblinds are fully closed.
- ▶ Keep the  switch pulled for an additional second.
- ▶ Make sure that the panorama roof with power tilt/sliding panel (▷ page 80) and the roller sunblinds (▷ page 81) can be fully opened and closed again.
- ▶ If this is not the case, repeat the steps above again.

Problems with the sliding sunroof

In the following section, the term "sliding sunroof" refers to the panorama roof with power tilt/sliding panel.

WARNING

You could be severely or even fatally injured when closing the sliding sunroof with increased closing force or if the anti-entrapment feature is deactivated. Make sure that nobody can become trapped when closing the sliding sunroof.

WARNING

Pressing and holding the sliding sunroof switch to close the sliding sunroof immediately after it had been blocked two times will cause the sliding sunroof to close

without the anti-entrapment feature for as long as you hold the switch.

- ❗ If the sliding sunroof still cannot be opened or closed as a result of a malfunction, contact a qualified specialist workshop.

Problem: the sunroof cannot be closed and you cannot see the cause. If the sliding sunroof is obstructed during closing and reopens again slightly:

- ▶ Immediately after the sliding sunroof blocks, pull the  switch in the overhead control panel down to the point of resistance and hold it until the sliding sunroof is closed.
The sliding sunroof is closed with increased force.

If the sliding sunroof is obstructed again during closing and reopens again slightly:

- ▶ Immediately after the sliding sunroof blocks, pull the  switch in the overhead control panel down to the point of resistance and hold it until the sliding sunroof is closed.
The sliding sunroof is closed without the anti-entrapment feature.

Useful information	84
Correcting the driver's seat position	84
Seats	85
Steering wheel	89
Mirrors	90
Memory functions	93

Useful information

- i** This Operator's Manual describes all models and all standard and optional equipment of your vehicle available at the time of publication of the Operator's Manual. Country-specific differences are possible. Please note that your vehicle may not be equipped with all features described. This also applies to safety-related systems and functions.
- i** Please read the information on qualified specialist workshops (▷ page 23).

Correcting the driver's seat position



Observe the safety guidelines on seat adjustment (▷ page 85).

- ▶ Make sure that seat ③ is adjusted properly.
 - Manual seat adjustment (▷ page 86)
 - Electrical seat adjustment (▷ page 87)
- When adjusting the seat, make sure that:
- you are as far away from the driver's air bag as possible.
 - you are sitting in a normal upright position.
 - you can fasten the seat belt properly.

- you have moved the backrest to an almost vertical position.
- you have set the seat cushion angle so that your thighs are gently supported.
- you can depress the pedals properly.

- ▶ Check whether the head restraint is adjusted properly (▷ page 87).

When doing so, make sure that you have adjusted the head restraint so that the back of your head is supported at eye level by the center of the head restraint.

Observe the safety guidelines on steering wheel adjustment (▷ page 89).

- ▶ Make sure that steering wheel ① is adjusted properly.

Adjusting the steering wheel (▷ page 89)

When adjusting the steering wheel, make sure that:

- you can hold the steering wheel with your arms slightly bent.
- you can move your legs freely.
- you can see all the displays in the instrument cluster clearly.

Observe the safety guidelines for seat belts (▷ page 43).

- ▶ Check whether you have fastened seat belt ② properly (▷ page 45).

The seat belt should:

- fit snugly across your body
 - be routed across the middle of your shoulder
 - be routed in your pelvic area across the hip joints
- ▶ Before starting off, adjust the rear-view mirror and the exterior mirrors (▷ page 90) in such a way that you have a good view of road and traffic conditions.
 - ▶ **Vehicles with a memory function:** save the seat and exterior mirror settings (▷ page 93).

Seats

Important safety notes

WARNING

The seats can still be adjusted when there is no key in the ignition lock. For this reason, children should never be left unsupervised in the vehicle. They could otherwise become trapped when adjusting the seat.

WARNING

In order to avoid possible loss of vehicle control, all seat, head restraint, steering wheel and rear view mirror adjustments, as well as fastening of seat belts, must be done before setting the vehicle in motion.

WARNING

Do not adjust the driver's seat while driving. Adjusting the seat while driving could cause the driver to lose control of the vehicle.

Never travel in a moving vehicle with the seat backrest in an excessively reclined position as this can be dangerous. You could slide under the seat belt in a collision. If you slide under it, the seat belt would apply force at the abdomen or neck. This could cause serious or fatal injuries. The seat backrest and seat belts provide the best restraint when the wearer is in a position that is as upright as possible and seat belts are properly positioned on the body.

WARNING

Your seat belt must be adjusted so that you can correctly fasten your seat belt.

Observe the following points:

- adjust the seat backrest until your arms are slightly angled when holding the steering wheel.
- adjust the seat to a comfortable seating position that still allows you to reach the accelerator/brake pedal safely. The position should be as far back as possible

with the driver still able to operate the controls properly.

- adjust the head restraint so that it is as close to the head as possible and the center of the head restraint supports the back of the head at eye level.
- never place hands under the seat or near any moving parts while a seat is being adjusted.

Failure to do so could result in an accident and/or serious personal injury.

WARNING

According to accident statistics, children are safer when properly restrained on the rear seats than on the front-passenger seat. Thus, we strongly recommend that children be placed in the rear seat whenever possible. Regardless of seating position, children 12 years old and under must be seated and properly secured in an appropriately sized child restraint system or booster seat recommended for the size and weight of the child. For additional information, see the "Children in the vehicle" section.

A child's risk of serious or fatal injuries is significantly increased if the child restraints are not properly secured in the vehicle and/or the child is not properly secured in the child restraint.

WARNING

Make sure that the back of your head is supported at eye level by the central area of the head restraint. If your head is not supported correctly by the head restraint, you could suffer a severe neck injury in the event of an accident. Never drive if the head restraints are not engaged and set correctly.

! To avoid damage to the seats and the seat heating, observe the following information:

- keep liquids from spilling on the seats. If liquid is spilled on the seats, dry them as soon as possible.
- if the seat covers are damp or wet, do not switch on the seat heating. The seat heating should also not be used to dry the seats.
- clean the seat covers as recommended; see the "Interior care" section.
- do not transport heavy loads on the seats. Do not place sharp objects on the seat cushions, e.g. knives, nails or tools. The seats should only be occupied by passengers, if possible.
- when the seat heating is in operation, do not cover the seats with insulating materials, e.g. blankets, coats, bags, seat covers, child seats or booster seats.

! Make sure that there are no objects in the footwell or behind the seats when resetting the seats. There is a risk that the seats and/or the objects could be damaged.

i The head restraints in the front and rear seats can be removed.

For more information, contact a qualified specialist workshop.

i Further related subjects:

- cargo compartment enlargement (folding down rear seat) (> page 234)

Adjusting the seats manually

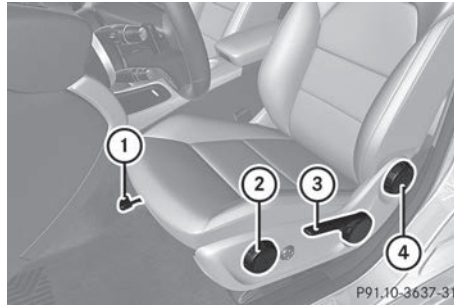

Seat fore-and-aft adjustment

- ▶ Lift handle ① and slide the seat forwards or backwards.
- ▶ Release lever ① again. Make sure that you hear the seat engage in position.

Backrest angle

- ▶ Relieve the pressure on the backrest.
- ▶ Turn handwheel ④ forwards or backwards.

Seat height

- ▶ Pull handle ③ upwards or push it down repeatedly until the seat has reached the desired height.

Seat cushion angle

Adjust the angle so that your thighs are lightly supported.

- ▶ Turn handwheel ② forwards or backwards.

Adjusting the seats electrically

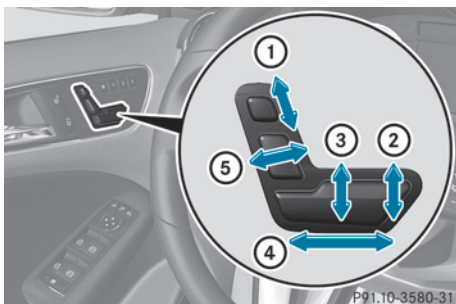

- ① Head restraint height³
 - ② Seat cushion angle
 - ③ Seat height
 - ④ Seat fore-and-aft adjustment
 - ⑤ Backrest angle
- i** You can store the seat settings using the memory function (▷ page 93).

Adjusting the head restraints

Adjusting the head restraints manually

Adjusting the head restraint height

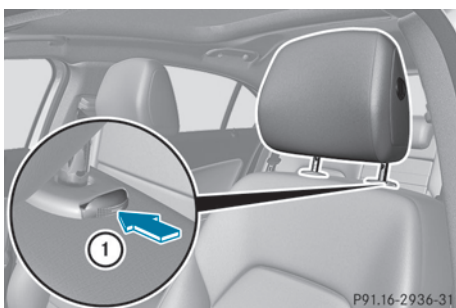

- ▶ **To raise:** pull the head restraint up to the desired position.
- ▶ **To lower:** press release catch ① in the direction of the arrow and push the head restraint down to the desired position.

Adjusting the fore/aft position of the head restraint

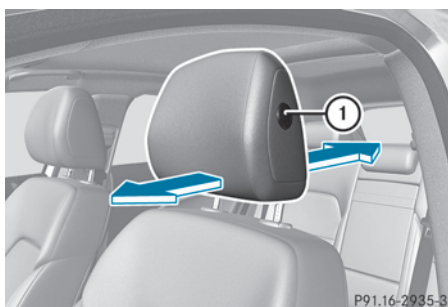

With this function you can adjust the distance between the head restraint and the back of the seat occupant's head.

- ▶ **To adjust forwards:** pull the head restraint forwards in the direction of the arrow until it engages. There are several notches.
- ▶ **To move backwards:** press and hold release button ① and push the head restraint backwards.
- ▶ When the head restraint is in the desired position, release the button and make sure that the head restraint is engaged in position.

Adjusting the head restraints electrically

- ▶ **To adjust the head restraint height:** slide the switch for head restraint adjustment (▷ page 87) up or down in the direction of the arrow.

Rear seat head restraints

Important safety notes

⚠ WARNING

For safety reasons, always drive with the rear head restraints in the upright position when the rear seats are occupied.

³ Not in vehicles with sports seats.

Keep the area around head restraints clear of articles (e.g. clothing) to not obstruct the folding operation of the head restraints.

WARNING

For your protection, drive only with properly positioned head restraints.

Adjust the head restraint in such a way that it is as close to the head as possible and the center of the head restraint supports the back of the head at eye level. This will reduce the potential for injury to the head and neck in the event of an accident or similar situation.

With a rear seat occupied, make sure to move the respective head restraint up from the lowest non-use position and have the occupant adjust the head restraint properly.

Do not drive the vehicle without the seat head restraints installed when the rear seats are occupied. Head restraints are intended to help reduce injuries during an accident.

Adjusting the rear seat head restraint height

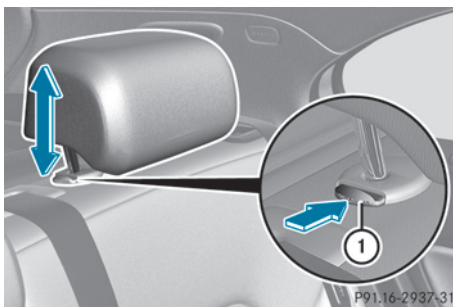

- ▶ **To raise:** pull the head restraint up to the desired position.
- ▶ **To lower:** press release catch ① and push the head restraint down until it is in the desired position.

Removing and installing the rear seat head restraints

WARNING

Occupants should only travel sitting on seats which have the head restraints installed. This

reduces the risk of injury to occupants in the event of an accident.

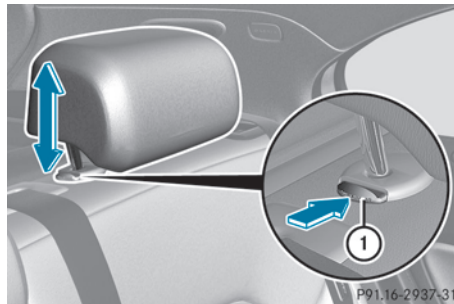

- ▶ Fold the seat backrest slightly forwards in order to remove the head restraint (▷ page 234).
- ▶ **To remove:** pull the head restraint up to the stop.
- ▶ Press release catch ① and pull the head restraint out of the guides.
- ▶ **To re-install:** insert the head restraint so that the notches on the bar are on the left when viewed in the direction of travel.
- ▶ Push the head restraint down until you hear it engage in position.

Adjusting the 4-way lumbar support

You can adjust the contour of the front seat backrests individually to provide optimum support for your back.

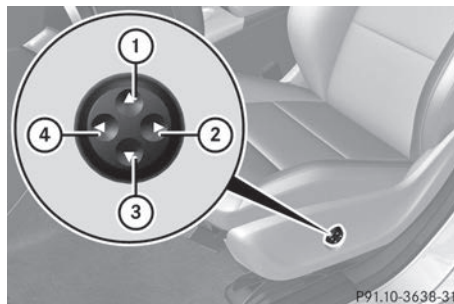

- ① To raise the backrest contour
- ② To soften the backrest contour

- ③ To lower the backrest contour
- ④ To harden the backrest contour

Switching the seat heating on/off

Activating/deactivating



The three red indicator lamps in the button indicate the heating level you have selected. The system automatically switches down from level **3** to level **2** after approximately eight minutes.

The system automatically switches down from level **2** to level **1** after approximately ten minutes.

The system automatically switches off approximately 20 minutes after it is set to level **1**.

- ▶ Make sure that the SmartKey is in position **1** or **2** in the ignition lock.
- ▶ **To switch on:** press button ① repeatedly until the desired heating level is set.
- ▶ **To switch off:** press button ① repeatedly until all the indicator lamps go out.

i If the battery voltage is too low, the seat heating may switch off.

Problems with the seat heating

The seat heating has switched off prematurely or cannot be switched on. The vehicle's electrical system voltage is too low because too many electrical consumers are switched on.

- ▶ Switch off electrical consumers that you do not need, such as the rear window defroster or interior lighting.

Steering wheel

Important safety notes

⚠ WARNING

Only adjust the steering wheel with the vehicle at a standstill and make sure the steering wheel is securely locked in place before driving off.

Driving without the steering wheel adjustment locked may cause an unexpected steering wheel movement which could cause the driver to lose control of the vehicle. Make sure the steering wheel is securely locked by trying to move it up and down, and in and out before driving off.

Adjusting the steering wheel

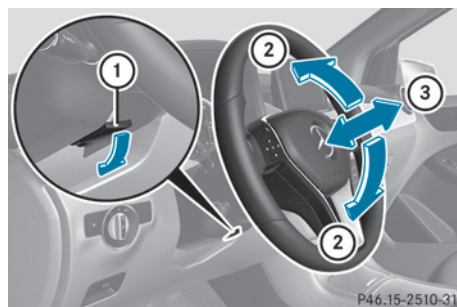

- ① Release lever
- ② To adjust the steering wheel height
- ③ To adjust the steering wheel position (fore-and-aft adjustment)

- ▶ Push release lever ① down completely. The steering column is unlocked.
- ▶ Adjust the steering wheel to the desired position.
- ▶ Push release lever ① up completely. The steering column is locked.
- ▶ Check if the steering column is locked. When doing so, try to push the steering wheel up or down or try to move it in the fore-and-aft direction.

Mirrors

Rear-view mirror

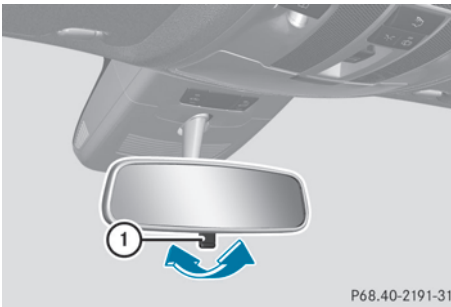

- ▶ **Anti-glare mode:** flick anti-glare lever ① forwards or back.

Exterior mirrors

Adjusting the exterior mirrors

WARNING

The exterior mirrors reduce the size of the image. Objects are actually closer than they appear. You could misjudge the distance from vehicles driving behind and cause an accident, e.g. when changing lane. For this reason, make sure of the actual distance from the vehicle driving behind by glancing over your shoulder.

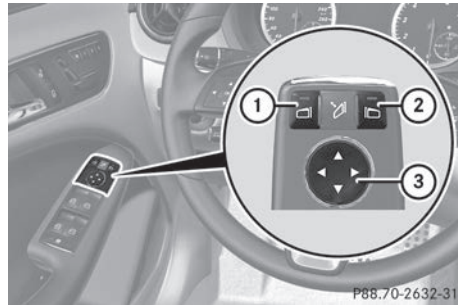

- ▶ Make sure that the SmartKey is in position 1 or 2 in the ignition lock.
- ▶ Press button ① for the left-hand exterior mirror or button ② for the right-hand exterior mirror. The indicator lamp in the corresponding button lights up in red. The indicator lamp goes out again after some time. You can adjust the selected mirror using adjustment button ③ as long as the indicator lamp is lit.
- ▶ Press adjustment button ③ up, down, or to the left or right until you have adjusted the exterior mirror to the correct position. You should have a good overview of traffic conditions.

The exterior mirrors are automatically heated after starting the vehicle if the rear window defroster is switched on and the outside temperature is low. Mirror heating lasts up to 10 minutes.

- i** You can also heat up the exterior mirrors manually by switching on the rear window defroster.

Folding the exterior mirrors in or out electrically



- ▶ Make sure that the SmartKey is in position **1** or **2** in the ignition lock.
 - ▶ Briefly press button **1**. Both exterior mirrors fold in or out.
- i** Make sure that the exterior mirrors are always folded out fully while driving. They could otherwise vibrate.

Setting the exterior mirrors

If the battery has been disconnected or completely discharged, the exterior mirrors must be reset. The exterior mirrors will otherwise not fold in when you select the "Fold in mirrors when locking" function in the on-board computer (▷ page 192).

- ▶ Make sure that the SmartKey is in position **1** in the ignition lock.
- ▶ Briefly press button **1**.

Folding the exterior mirrors in or out automatically

If the "Fold in mirrors when locking" function is activated in the on-board computer (▷ page 192):

- the exterior mirrors fold in automatically as soon as you lock the vehicle from the outside.
- the exterior mirrors fold out again automatically as soon as you unlock the vehicle and then open the driver's or front-passenger door.

- i** If the exterior mirrors have been folded in manually, they do not fold out.

Exterior mirror out of position

If an exterior mirror has been pushed out of position, proceed as follows:

- ▶ **Vehicles without electrically folding exterior mirrors:** move the exterior mirror into the correct position manually.
- ▶ **Vehicles with electrically folding exterior mirrors:** press and hold mirror-folding button (▷ page 91) until you hear a click and then the mirrors engage in position. The mirror housing is engaged again and you can adjust the exterior mirrors as usual (▷ page 90).

Automatic anti-glare mirrors

⚠ WARNING

If incident light from headlamps is prevented from striking the sensor in the rear-view mirror, for instance, by luggage piled too high in the vehicle, the mirror's automatic anti-glare function will not operate.

Incident light could then blind you. This may distract you from the traffic conditions and, as a result, you may cause an accident.

The "Automatic anti-glare mirrors" function is only available if the vehicle is equipped with the "Mirrors package".

The rear-view mirror and the exterior mirror on the driver's side automatically go into anti-glare mode if:

- the ignition is switched on and
- incident light from headlamps strikes the sensor in the rear-view mirror.

The mirrors do not go into anti-glare mode if reverse gear is engaged or the interior lighting is switched on.

Parking position for the exterior mirror on the front-passenger side

General notes

The "Parking position of the exterior mirror on the front-passenger side" function is only available if the vehicle is equipped with the "Mirrors package".

Setting and storing the parking position

Using reverse gear

You can position the front-passenger side exterior mirror in such a way that you can see the rear wheel on that side as soon as you engage reverse gear. You can store this position.

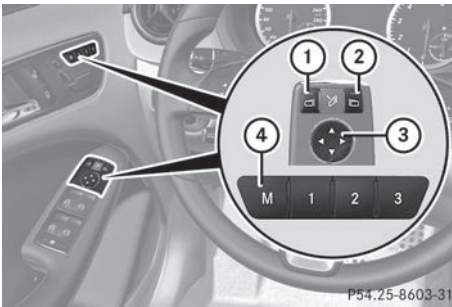

- ▶ Make sure that the vehicle is stationary and that the SmartKey is in position **2** in the ignition lock.
 - ▶ Press button **②** for the exterior mirror on the front-passenger side.
 - ▶ Engage reverse gear.
The exterior mirror on the front-passenger side moves to the preset parking position.
 - ▶ Use adjustment button **③** to adjust the exterior mirror. You should see the rear wheel and the curb in the exterior mirror. The parking position is stored.
- i** If you shift the transmission to another position, the exterior mirror on the front-passenger side returns to the driving position.

Using the memory button

You can position the front-passenger side exterior mirror in such a way that you can see the rear wheel on that side as soon as you engage reverse gear. You can store this position. This setting can be stored using memory button **M** **④**.

- ▶ Make sure that the vehicle is stationary and that the SmartKey is in position **2** in the ignition lock.
- ▶ Press button **②** for the exterior mirror on the front-passenger side.
- ▶ Engage reverse gear.
The exterior mirror on the front-passenger side moves to the preset parking position.
- ▶ Use adjustment button **③** to adjust the exterior mirror. You should see the rear wheel and the curb in the exterior mirror.
- ▶ Press memory button **M** **④** and one of the arrows on adjustment button **③** within three seconds.
The parking position is stored if the exterior mirror does not move.
- ▶ If the mirror moves out of position, repeat the steps.

Calling up a stored parking position setting

- ▶ Turn the SmartKey to position **2** in the ignition lock.
- ▶ Adjust the exterior mirror on the front-passenger side with the corresponding button (> page 90).
- ▶ Engage reverse gear.
The exterior mirror on the front-passenger side moves to the stored parking position.

The exterior mirror on the front-passenger side moves back to its original position:

- as soon as you exceed a speed of 9 mph (15 km/h)
- about ten seconds after you have disengaged reverse gear
- if you press button **①** for the exterior mirror on the driver's side

Memory functions

Storing settings

WARNING

Only use the memory function on the driver's side when the vehicle is stationary. You could otherwise be distracted from the traffic conditions by the seat moving of its own accord, and as a result cause an accident.

With the memory function, you can store up to three different settings, e.g. for three different people.

The following settings are stored as a single memory preset:

- position of the seat, backrest and head restraint
- driver's side: position of the exterior mirrors on the driver's and front-passenger sides



P54.25-8604-31

- ▶ Adjust the seat (> page 87).
- ▶ Adjust the exterior mirror on the driver's side (> page 90).
- ▶ Briefly press the **M** memory button and then press storage position button **1**, **2** or **3** within three seconds.

The settings are stored in the selected preset position. A tone sounds when the settings have been completed.

Calling up a stored setting

- ▶ Press and hold the relevant storage position button **1**, **2** or **3** until the seat and exterior mirrors are in the stored position.
- i** The setting procedure is interrupted as soon as you release the storage position button.

Useful information 96
Exterior lighting 96
Interior lighting 101
Replacing bulbs 102
Windshield wipers 109

Useful information

- i** This Operator's Manual describes all models and all standard and optional equipment of your vehicle available at the time of publication of the Operator's Manual. Country-specific differences are possible. Please note that your vehicle may not be equipped with all features described. This also applies to safety-related systems and functions.
- i** Please read the information on qualified specialist workshops (▷ page 23).

Exterior lighting

Important safety notes

For reasons of safety, Mercedes-Benz recommends that you drive with the lights switched on even during the daytime. In some countries, operation of the headlamps varies due to legal requirements and self-imposed obligations.

Driving abroad

Conversion to symmetrical low beam

Switch the headlamps to symmetrical low beam in countries in which traffic drives on the opposite side of the road from the country where the vehicle is registered. This prevents glare to oncoming traffic. When using symmetrical lights, the edge of the road is not lit as widely and as far ahead as normal.

Have the headlamps converted at a qualified specialist workshop as close to the border as possible before driving in these countries.

Conversion to asymmetrical low beam after returning

Have the headlamps converted back to asymmetrical low-beam headlamps at a qualified specialist workshop as soon as possible after crossing the border again.

Setting the exterior lighting

Setting options

Exterior lighting can be set using:

- the light switch
- the combination switch (▷ page 98)
- the on-board computer (▷ page 190)

Light switch

Operation

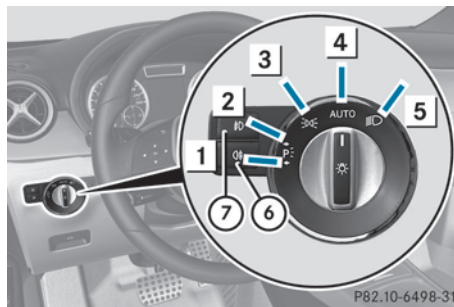

- 1** Left-hand standing lamps
- 2** Right-hand standing lamps
- 3** Parking lamps, license plate and instrument cluster lighting
- 4** **AUTO** Automatic headlamp mode, controlled by the light sensor
- 5** Low-beam/high-beam headlamps
- 6** Rear fog lamp
- 7** Fog lamp (only vehicles with front fog lamps)

If you hear a warning tone when you leave the vehicle, the lights may still be switched on.

- Turn the light switch to **AUTO**.

The exterior lighting (except the parking/standing lamps) switches off automatically if you:

- remove the SmartKey from the ignition lock
- open the driver's door with the SmartKey in position **0**.

Automatic headlamp mode

WARNING

If the light switch is set to **AUTO** and it is foggy, snowing or there is poor visibility, the low-beam headlamps will not come on automatically. This could endanger you and others. In such situations turn the light switch to .

The automatic headlamp feature is only an aid. The driver is responsible for the vehicle's lighting at all times.

AUTO is the favored light switch setting. The light setting is automatically selected according to the brightness of the ambient light (exception: poor visibility due to weather conditions such as fog, snow or spray):

- SmartKey in position **1** in the ignition lock: the parking lamps are switched on or off automatically depending on the brightness of the ambient light.
- With the engine running: if you have activated the daytime running lamps function via the on-board computer, the daytime running lamps or the low-beam headlamps and parking lamps are switched on or off automatically depending on the brightness of the ambient light.

▶ **To switch on automatic headlamp mode:** turn the light switch to **AUTO**.

The daytime running lamps improve the visibility of your vehicle during the day. The daytime running lamps function is required by law in Canada. It cannot therefore be deactivated.

When the engine is running and the vehicle is stationary: if you move the selector lever from a drive position to **P**, the daytime running lamps/low-beam headlamps go out after three minutes.

When the engine is running, the vehicle is stationary and in high ambient light brightness: if you turn the light switch to , you turn on the daytime running lamps and parking lamps.

If the engine is running and you turn the light switch to , the manual settings take precedence over the daytime running lamps.

Low-beam headlamps

WARNING

If the light switch is set to **AUTO** and it is foggy, snowing or there is poor visibility, the low-beam headlamps will not come on automatically. This could endanger you and others. In such situations turn the light switch to .

The automatic headlamp feature is only an aid. The driver is responsible for the vehicle's lighting at all times.

Even if the light sensor does not detect that it is dark, the parking lamps and low-beam headlamps switch on when the SmartKey is inserted into the ignition lock and the light switch is set to the  position. This is a particularly useful function in the event of rain and fog.

▶ **To switch on the low-beam headlamps:** turn the SmartKey in the ignition lock to position **2** or start the engine.

▶ Turn the light switch to .





The green  indicator lamp in the instrument cluster lights up.

Front fog lamps

In conditions where visibility is poor due to fog, snow or rain, the fog lamps improve visibility as well as making it easier for other road users to see you. They can be operated together with the parking lamps or together with the parking lamps and low-beam headlamps.

▶ **To switch on the front fog lamps:** turn the SmartKey in the ignition lock to position **2** or start the engine.





▶ Turn the light switch to or **AUTO**.

- ▶ Press the  button.
The green  indicator lamp in the instrument cluster lights up.
- ▶ **To switch off the front fog lamps:** press the  button.
The green  indicator lamp in the instrument cluster goes out.





Only vehicles with front fog lamps are equipped with the "fog lamp" function; information on the fog lamp function for vehicles with Intelligent Light System (▷ page 100).

Rear fog lamp

The rear fog lamp improves visibility of your vehicle for the traffic behind in the event of heavy fog. Please take note of the country-specific regulations for the use of rear fog lamps.



- ▶ **To switch on the rear fog lamp:** turn the SmartKey in the ignition lock to position **2** or start the engine.
- ▶ Turn the light switch to  or **AUTO**.
- ▶ Press the  button.
The yellow  indicator lamp in the instrument cluster lights up.
- ▶ **To switch off the rear fog lamp:** press the  button.
The yellow  indicator lamp in the instrument cluster goes out.

Parking lamps

- ❗ If the battery has been excessively discharged, the parking lamps or standing lamps are automatically switched off to enable the next engine start. Always park your vehicle safely and sufficiently lit according to legal standards. Avoid the continuous use of the  parking lamps for several hours. If possible, switch on the  right or the  left standing lamp.
- ▶ **To switch on:** turn light switch to .
The green  indicator lamp in the instrument cluster lights up.

Standing lamps

Switching on the standing lamps ensures the corresponding side of the vehicle is illuminated.

- ▶ **To switch on the standing lamps:** the SmartKey is not in the ignition lock or it is in position **0**.
- ▶ Turn the light switch to  (left-hand side of the vehicle) or  (right-hand side of the vehicle).

Combination switch

Turn signals

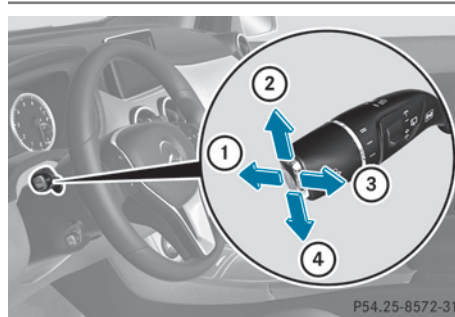



- ① High-beam headlamps
- ② Turn signal, right
- ③ High-beam flasher
- ④ Turn signal, left

- ▶ **To indicate briefly:** press the combination switch briefly to the pressure point in the direction of arrow ② or ④.
The corresponding turn signal flashes three times.
- ▶ **To indicate:** press the combination switch beyond the pressure point in the direction of arrow ② or ④.

High-beam headlamps

- ▶ **To switch on the high-beam headlamps:** turn the SmartKey in the ignition lock to position **2** or start the engine.
- ▶ Turn the light switch to  or **AUTO**.

- ▶ Press the combination switch beyond the pressure point in the direction of arrow ①.
In the **AUTO** position, the high-beam headlamps are only switched on when it is dark and the engine is running.
The blue  indicator lamp in the instrument cluster lights up when the high-beam headlamps are switched on.
- ▶ **To switch off the high-beam headlamps:** move the combination switch back to its normal position.
The blue  indicator lamp in the instrument cluster goes out.
- ❗ Vehicles with Adaptive Highbeam Assist: when Adaptive Highbeam Assist is active, it controls activation of the high-beam headlamps (▶ page 100).

High-beam flasher

- ▶ **To switch on:** turn the SmartKey in the ignition lock to position **1** or **2** or start the engine.
- ▶ Pull the combination switch in the direction of arrow ③.

Hazard warning lamps

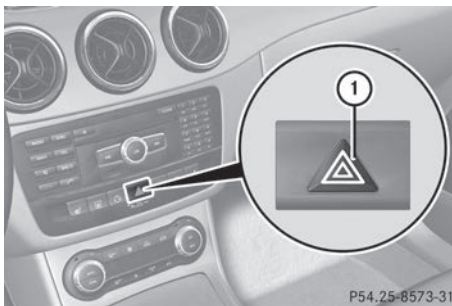

The hazard warning lamps automatically switch on if:

- an air bag is deployed.
- the vehicle is slowed down rapidly from a speed of over 45 mph (70 km/h) and comes to a halt.

- ▶ **To switch on the hazard warning lamps:** press button ①.
All turn signals flash. If you now switch on a turn signal using the combination switch, only the turn signal lamp on the corresponding side of the vehicle will flash.
- ▶ **To switch off the hazard warning lamps:** press button ①.

If the vehicle returns to a speed of over 6 mph (10 km/h) after a full application of the brakes, the hazard warning lamps are deactivated automatically.

- ❗ The hazard warning lamps still operate if the ignition is switched off.

Headlamp cleaning system

The headlamps are cleaned automatically if the "Wipe with washer fluid" function is operated five times while the lights are on and the engine is running (▶ page 109). When you switch off the ignition, the automatic headlamp cleaning system is reset and counting is resumed from 0.

Cornering light function



The cornering light function improves the illumination of the road over a wide angle in the direction you are turning, enabling better visibility in tight bends, for example. The cornering light function can only be activated when the low-beam headlamps are switched on.

Active:

- if you are driving at speeds below 25mph (40 km/h) and switch on the turn signal or turn the steering wheel.
- if you are driving at speeds between 25mph (40 km/h) and 45mph (70 km/h) and turn the steering wheel

Not active: if you are driving at speeds above 25 mph (40 km/h) or switch off the turn signals or turn the steering wheel to the straight-ahead position.

The cornering light function may remain lit for a short time, but is automatically switched off after no more than three minutes.

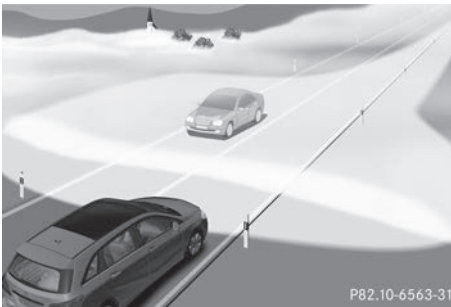
Extended range fog lamps

The extended range fog lamps reduce the glare experienced by the driver and improve the illumination of the edge of the road.

Active: if you are driving at speeds below 40 mph (70 km/h) and you switch on the rear fog lamp

Not active: if you are driving at speeds above 60 mph (100 km/h) or if you switch off the rear fog lamp following activation

Adaptive Highbeam Assist**⚠ WARNING**

The Adaptive Highbeam Assist is only an aid intended to support you while driving. The driver is and remains responsible for proper

vehicle lighting in accordance with the prevailing light, sight and traffic conditions.

The system may be impaired or unavailable when

- visibility is poor, e.g. due to snow, rain, fog, or heavy spray
- the optical sensor area of the windshield is dirty, fogged up, or covered by a sticker for example

The system cannot recognize the following road users:

- Road users without a lighting system of their own, e.g. pedestrians
- Road users with dim lighting of their own, e.g. cyclists
- Road users whose lighting is obstructed, e.g. road users behind a guardrail
- In some seldom cases, even road users with a lighting system of their own may be recognized too late or not at all.

The automatic high-beam headlamps will then not be deactivated or it will be activated in spite of preceding or oncoming road users.

This could endanger you and/or others and cause an accident. Always pay close attention to the traffic situation and switch off the high beam manually if necessary.

You can use this function to set the headlamps to change between low beam and high beam automatically. The system recognizes vehicles with their lights on, either approaching from the opposite direction or traveling in front of your vehicle, and consequently switches the headlamps from high beam to low beam.

The system automatically adapts the low-beam headlamp range depending on the distance to the other vehicle. Once the system no longer detects any other vehicles, it reactivates the high-beam headlamps.

The system's optical sensor is located behind the windshield near the overhead control panel.



- ▶ **To activate:** activate the Adaptive Highbeam Assist function using the on-board computer (> page 190).
- ▶ Turn the light switch to **AUTO**.
- ▶ Press the combination switch beyond the pressure point in the direction of arrow ① (> page 98).

The  indicator lamp in the multifunction display lights up if it is dark and the light sensor activates the low-beam headlamps.



If you drive at speeds above approximately 28 mph (45 km/h):

the headlamp range is set automatically depending on the distance between the vehicle and other road users.

If you are driving at speeds above approximately 35 mph (55 km/h) and no other road users have been detected:

the high-beam headlamps are switched on automatically. The  indicator lamp in the instrument cluster also lights up.

If you drive at speeds below approximately 30 mph (45 km/h) or if other road users are identified or if the roads are sufficiently illuminated:

the high-beam headlamps are switched off automatically. The  indicator lamp in the instrument cluster goes out. The  indicator lamp in the multifunction display remains lit.

- ▶ **To deactivate:** move the combination switch back to its normal position. The  indicator lamp in the multifunction display goes out.

Headlamps fogged up on the inside

The headlamps may fog up on the inside if there is high atmospheric humidity.

- ▶ Switch on the lights and drive off. The level of moisture diminishes, depending on the length of the journey and the weather conditions (humidity and temperature).

If the level of moisture does not diminish:



- ▶ Have the headlamps checked at a qualified specialist workshop.

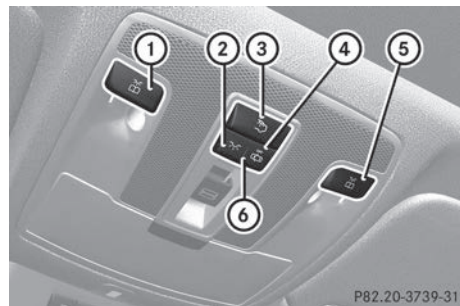

Interior lighting

Overview of interior lighting



Front overhead control panel

- ①  To switch the left-hand front reading lamp on/off
- ②  To switch the front interior lighting on
- ③  To switch the rear interior lighting on/off

- ④  To switch the front interior lighting/ automatic interior lighting control off
- ⑤  To switch the right-hand front reading lamp on/off
- ⑥ To switch the automatic interior lighting control on

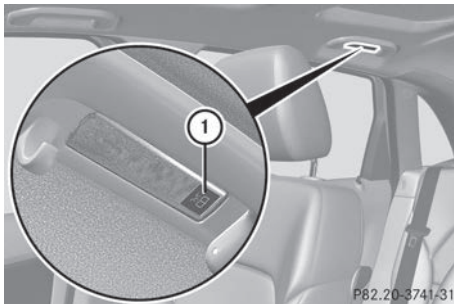

Rear-compartment overhead control panel

- ① To switch the reading lamp on/off

Interior lighting control

Important notes

In order to prevent the vehicle's battery from discharging, the interior lighting functions are automatically deactivated after some time unless the SmartKey is in position **2** in the ignition lock.

Automatic interior lighting control

- ▶ **To switch on:** set the switch to center position ⑥.
- ▶ **To switch off:** set the switch to the  position.





The interior lighting automatically switches on if you:

- unlock the vehicle
- open a door
- remove the SmartKey from the ignition lock

The interior light is activated for a short while when the SmartKey is removed from the ignition lock. You can activate this delayed

switch-off using the on-board computer (> page 191).

Manual interior lighting control

- ▶ **To switch the front interior lighting on:** set the switch to the  position.
- ▶ **To switch off the interior lighting:** set the switch to the  position or (if the door is closed) to the center position.
- ▶ **To switch the rear interior lighting on/off:** press the  button.
- ▶ **To switch the reading lamps on/off:** press the  button.

Crash-responsive emergency lighting

The interior lighting is activated automatically if the vehicle is involved in an accident.

- ▶ **To switch off the crash-responsive emergency lighting:** press the hazard warning lamp button.
- or
- ▶ Lock and then unlock the vehicle using the key.

Replacing bulbs

Important safety notes

Xenon bulbs

DANGER

Xenon bulbs carry a high voltage. You could get an electric shock and be seriously or even fatally injured if you touch the electric contacts on Xenon bulbs. Therefore, never remove the cover from Xenon bulbs.

Do not change the Xenon bulbs yourself, but have them replaced at a qualified workshop.

If your vehicle is equipped with Xenon bulbs, you can recognize this by the following: the cone of light from the Xenon bulbs moves from the top to the bottom and back again when you start the engine. For this to be

observed, the lights must be switched on before starting the engine.

Bulbs and lamps are an important aspect of vehicle safety. You must therefore make sure that these function correctly at all times. Have the headlamp setting checked regularly.

Other bulbs

WARNING

Bulbs and lamps can become very hot. For this reason, allow them to cool down before changing them. Otherwise, you could burn yourself when you touch them.

Keep bulbs out of the reach of children. Otherwise, they could, for example, damage the bulbs and injure themselves.

Never use a bulb which has been dropped. Such a bulb may explode and injure you.

Halogen bulbs are pressurized and could explode when you change them, especially if they are very hot. You should therefore wear eye protection and gloves when you are changing them.

There are bulbs other than the Xenon bulbs that you cannot replace. Replace only the bulbs listed (> page 103). Have the bulbs that you cannot replace yourself changed at a qualified specialist workshop.

If you require assistance changing bulbs, consult a qualified specialist workshop.

Do not touch the glass tube of new bulbs with your bare hands. Even minor contamination can burn into the glass surface and reduce the service life of the bulbs. Always use a lint-free cloth or only touch the base of the bulb when installing.

Only use bulbs of the correct type.

If the new bulb still does not light up, consult a qualified specialist workshop.

Bulbs and lamps are an important aspect of vehicle safety. You must therefore make sure that these function correctly at all times. Have the headlamp setting checked regularly.

Overview: changing bulbs/bulb types

You can change the following bulbs. The bulb type can be found in the legend.

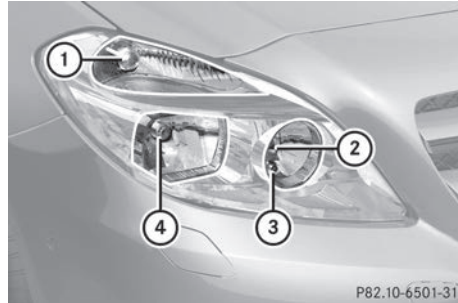

Halogen headlamps

- ① Turn signal lamp: 3457
- ② High-beam headlamp: H7 55 W
- ③ Parking lamp/standing lamp: W 5 W LL
- ④ Low-beam headlamp: H7 55 W

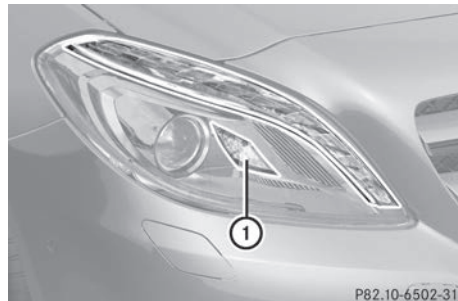

Vehicles with Intelligent Light System

- ① Cornering lamp: H7 55 W

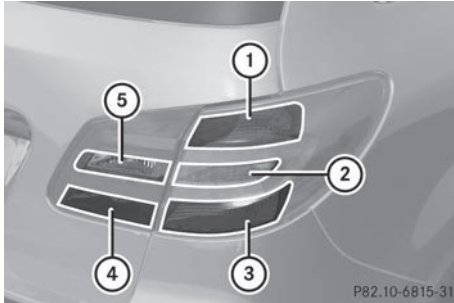

P82.10-6815-31

Tail lamp (halogen headlamps)

- ① Tail lamp/turn signal lamp/brake lamp: P 21 W
- ② Inoperative
- ③ Side marker lamp: P 21 W
- ④ Rear fog lamp: P 21 W
- ⑤ Backup lamp: W 16 W

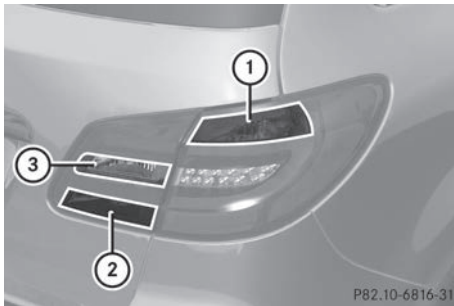

P82.10-6816-31

Tail lamp (Bi-Xenon headlamps)

- ① Turn signal lamp/brake lamp: P 21 W
- ② Rear fog lamp: H 21 W
- ③ Backup lamp: W 16 W

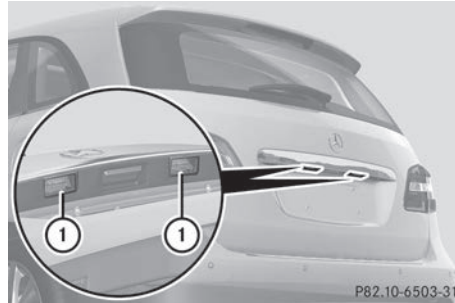

P82.10-6503-31

License plate lamp (vehicles with halogen headlamps)

- ① License plate lamp: C 5 W

Changing the front bulbs

Removing and installing the cover in the front wheel housing

You must remove the cover from the front wheel housing before you can change the front bulbs.

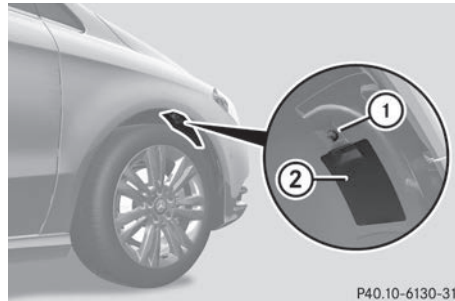

P40.10-6130-31

- ▶ **To remove:** switch off the lights.
- ▶ Turn the front wheels inwards.
- ▶ Turn rotary knob ① through 90°.
Cover ② is released.
- ▶ Push cover ② down.
- ▶ **To install:** push cover ② up.
- ▶ Turn rotary knob ① through 90°.
Cover ② is locked.

Low-beam headlamps (halogen headlamps)

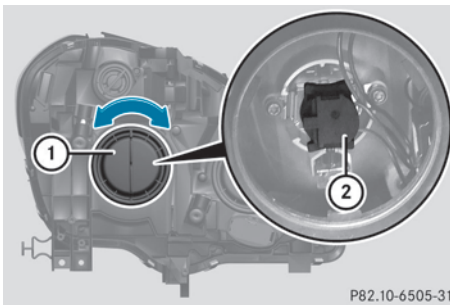

- ▶ Remove the cover in the front wheel housing (▷ page 104).
- ▶ Turn housing cover ① counter-clockwise and pull it out.
- ▶ Turn bulb holder ② counter-clockwise and pull it out.
- ▶ Take the bulb out of bulb holder ②.
- ▶ Insert the new bulb into bulb holder ②.
- ▶ Insert bulb holder ② into the lamp and turn it clockwise.
- ▶ Align housing cover ① and turn it clockwise until it engages.
- ▶ Replace the cover in the front wheel housing (▷ page 104).

High-beam headlamps (halogen headlamps)

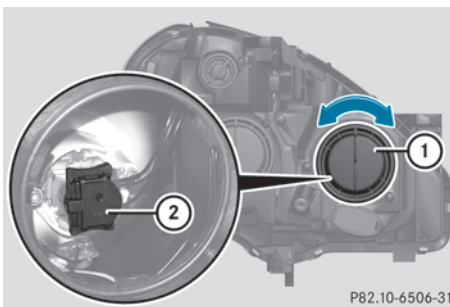

- ▶ Switch off the lights.
- ▶ Open the hood.

- ▶ Turn housing cover ① counter-clockwise and pull it out.
- ▶ Turn bulb holder ② counter-clockwise and pull it out.
- ▶ Take the bulb out of bulb holder ②.
- ▶ Insert the new bulb into bulb holder ②.
- ▶ Insert bulb holder ② into the lamp and turn it clockwise.
- ▶ Align housing cover ① and turn it clockwise until it engages.

Parking lamps/standing lamps (halogen headlamps)

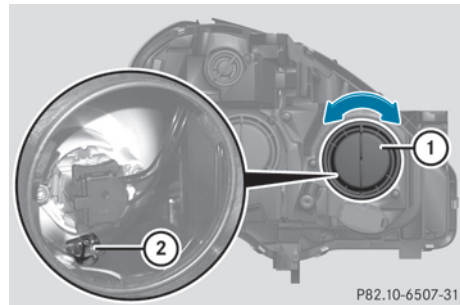

- ▶ Switch off the lights.
- ▶ Open the hood.
- ▶ Turn housing cover ① counter-clockwise and pull it out.
- ▶ Pull out bulb holder ②.
- ▶ Take the bulb out of bulb holder ②.
- ▶ Insert the new bulb into bulb holder ②.
- ▶ Insert bulb holder ②.
- ▶ Align housing cover ① and turn it clockwise until it engages.

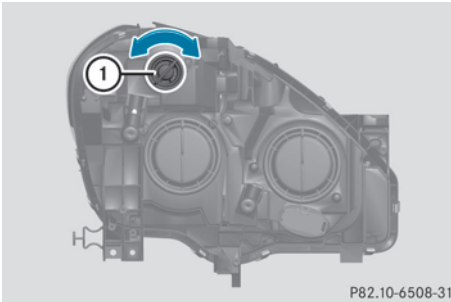
Turn signal lamp (halogen headlamps)

P82.10-6508-31

- ▶ Switch off the lights.
- ▶ Open the hood.
- ▶ Turn bulb holder ① counter-clockwise and pull it out.
- ▶ Take the bulb out of bulb holder ①.
- ▶ Insert the new bulb into bulb holder ①.
- ▶ Insert bulb holder ① and turn it clockwise until it engages.

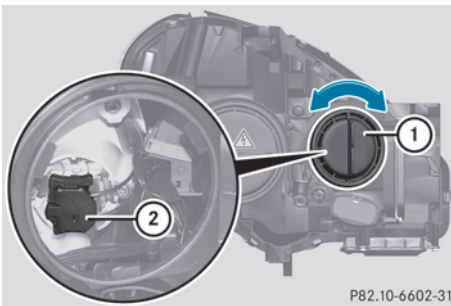
Cornering light function (Intelligent Light System)

P82.10-6602-31

- ▶ Switch off the lights.
- ▶ Open the hood.
- ▶ Turn housing cover ① counter-clockwise and pull it out.
- ▶ Turn bulb holder ② counter-clockwise and pull it out.
- ▶ Take the bulb out of bulb holder ②.
- ▶ Insert the new bulb into bulb holder ②.

- ▶ Insert bulb holder ② into the lamp and turn it clockwise.
- ▶ Align housing cover ① and turn it clockwise until it engages.

Changing the rear bulbs**Opening and closing the side trim panels**

You must open the side trim panel in the cargo compartment before you can change the bulbs in the tail lamps.

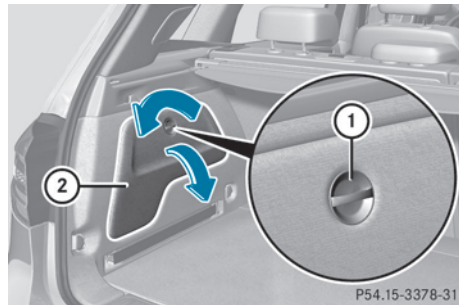

P54.15-3378-31

Left-hand side trim panel

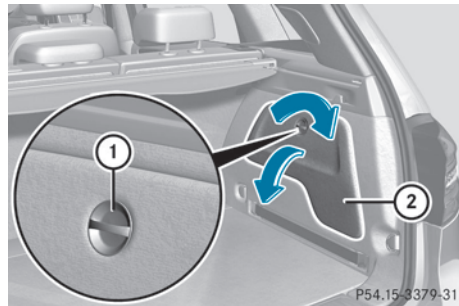

P54.15-3379-31

Right-hand side trim panel

- ▶ **To open:** turn release knob ① 90° in the direction of the arrow and remove side trim panel ②.
- ▶ **To close:** insert side trim panel ② and turn release knob ① 90° in the opposite direction to the arrow.

Tail lamp

Turn signal lamp/tail lamp and brake lamp

- ▶ Switch off the lights.
- ▶ Open the cargo compartment.
- ▶ Open the side trim panel (▷ page 106).

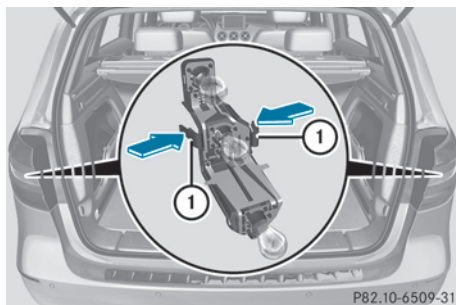

- ▶ Press retaining lugs ① simultaneously in the direction of the arrow and pull the bulb holder out.

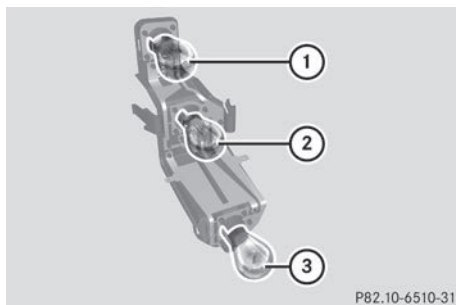

Bulb holder

- ① Tail lamps/brake lamps⁴
- ② Inoperative lamps (vehicles without LEDs)
- ③ Side marker lamp (vehicles without LEDs)

- ▶ Lightly press the corresponding bulb into the holder, turn it counter-clockwise and remove it from the bulb holder.
- ▶ Insert the corresponding new bulb into the bulb holder and turn it clockwise.

⁴ Vehicles with LEDs: turn signal/brake light only.

- ▶ Attach the bulb holder and press firmly. The retaining lugs on the bulb holder engage audibly.
- ▶ Close the side trim panel (▷ page 106).

Backup lamp and rear fog lamp

Due to their location, have the bulbs in the backup lamp and rear fog lamp in the tailgate changed at a qualified specialist workshop.

- ▶ Switch off the lights.
- ▶ Open the tailgate.

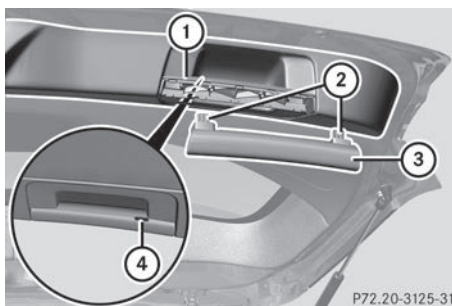

- ▶ In recess ④ on the inside of the closing handle, pry off and remove the upper section of handle ③ with a flat and smooth object, e.g. a screwdriver.
- ▶ Pull the lower section of handle ① using a sharp, sudden movement to remove it from the trim and then place it to one side.

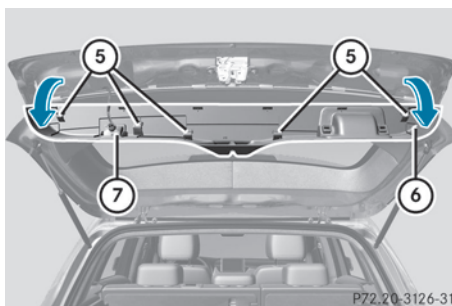

- ▶ Reach under the right-hand side of trim ⑥ and apply a gentle jolting force along the entire length of the trim in order to unclip it.

- ▶ Pull out connector ⑦ of the surround lighting by releasing the latches.
- ▶ Place trim ⑥ to one side.



- ▶ On the side where the bulb is to be changed, unclip the remaining part of trim ⑧ from the assembly using a sudden, sharp movements, until bulb holder ⑨ is accessible.

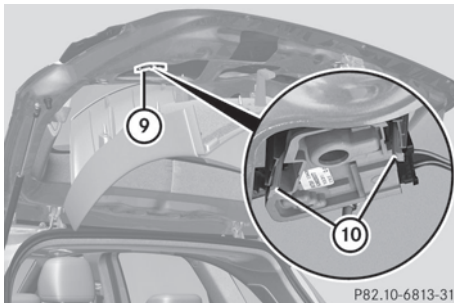

- ▶ Remove bulb holder ⑨ using both sides of lever ⑩.

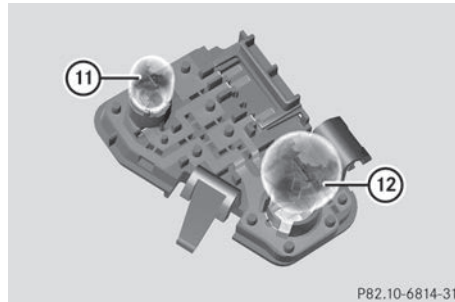

Bulb holder

- ▶ **Rear fog lamp ⑪**: lightly press the corresponding bulb into holder ⑨, turn it counter-clockwise and remove it from bulb holder ⑨.
- ▶ Insert the new bulb into bulb holder ⑨ and turn it clockwise.
- ▶ **backup lamp ⑫**: remove the bulb from bulb holder ⑨.
- ▶ Insert the new bulb into bulb holder ⑨.
- ▶ Re-insert bulb holder ⑨ until you hear engage audibly.
- ▶ Position trim ⑧ and engage it in place by tapping it with your hand.
- ▶ Before beginning the installation, check that all the metal clips are inserted in the parts placed to one side: 2 clips ② in the upper part of handle ③ and 5 clips ⑤ in trim ⑥.
- ▶ If not, remove the missing metal clips from the metal openings in the tailgate and insert them in the appropriate places.
- ▶ Take trim ⑥ and connect plug connector ⑦ to the surround lighting.

i The surround lighting only illuminates when the tailgate has been shut and reopened.

- ▶ Position trim ⑥ and engage it in place by tapping it with your hand, starting from the outside.
- ▶ Clip in the lower section of handle ① again.
- ▶ Insert and engage the upper section of handle ③ into lower section ①.

License plate lamp

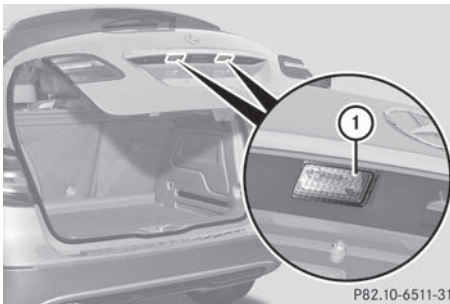

- ▶ Switch off the lights.
- ▶ Open the tailgate.
- ▶ Position a screwdriver on lamp lens ① from the outside.
- ▶ Lever out lamp lens ① and remove it.
- ▶ Replace the bulb.
- ▶ Insert lamp lens ① into the license plate lamp and press it in until it engages.

Windshield wipers

Switching the windshield wipers on/off

WARNING

The windshield will not longer be wiped properly if the wiper blades are worn. This could prevent you from observing the traffic conditions, thereby causing an accident. Replace the wiper blades twice a year, ideally in spring and fall.

- ❗ Do not operate the windshield wipers when the windshield is dry, as this could damage the wiper blades. Moreover, dust that has collected on the windshield can





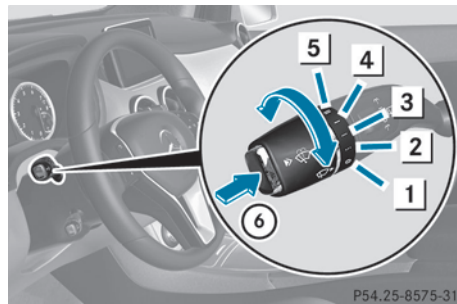

scratch the glass if wiping takes place when the windshield is dry.

If it is necessary to switch on the windshield wipers in dry weather conditions, always use washer fluid when operating the windshield wipers.

- ❗ If the windshield wipers leave smears on the windshield after the vehicle has been washed in an automatic car wash, wax or other residues may be the reason for this. Clean the windshield using washer fluid after washing the vehicle in an automatic car wash.



Combination switch

- ①  Windshield wipers off
- ②  Intermittent wipe, low (rain sensor set to low sensitivity)
- ③  Intermittent wipe, high (rain sensor set to high sensitivity)
- ④  Continuous wipe, slow
- ⑤  Continuous wipe, fast
- ⑥  Single wipe/  To wipe the windshield using washer fluid

- ▶ Switch on the ignition.
- ▶ Turn the combination switch to the corresponding position.

- ❗ Vehicles with a rain sensor: if the windshield becomes dirty in dry weather conditions, the windshield wipers may be activated inadvertently. This could then damage the windshield wiper blades or scratch the windshield.

For this reason, you should always switch off the windshield wipers in dry weather.

Vehicles with a rain sensor: in the **[...]** or **[....]** position, the appropriate wiping frequency is automatically set according to the intensity of the rain. In the **[....]** position, the rain sensor is more sensitive than in the **[...]** position, causing the windshield wipers to wipe more frequently.

Switching the rear window wiper on/off

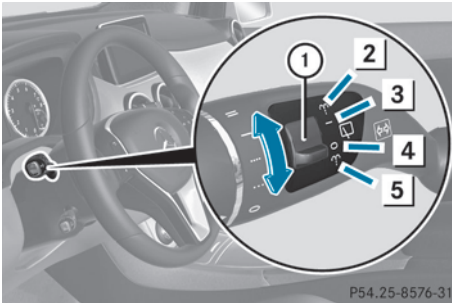

Combination switch

- ① Switch
- ② To wipe with washer fluid
- ③ To switch on intermittent wiping
- ④ **0** To switch off intermittent wiping
- ⑤ To wipe with washer fluid

- ▶ Turn the SmartKey to position **1** or **2** in the ignition lock.
- ▶ Turn switch ① on the combination switch to the corresponding position. When the rear window wiper is switched on, the icon appears in the instrument cluster.

Replacing the wiper blades

Important safety notes

WARNING

For safety reasons, switch off the wipers and remove the SmartKey from the starter switch

before replacing a wiper blade. Otherwise, the wiper motor could suddenly turn on and cause injury.

! To avoid damaging the wiper blades, make sure that you touch only the wiper arm of the wiper.

! Never open the hood/tailgate if a wiper arm has been folded away from the windshield/rear window.

Never fold a windshield wiper arm without a wiper blade back onto the windshield/rear window.

Hold the windshield wiper arm firmly when you change the wiper blade. If you release the wiper arm without a wiper blade and it falls onto the windshield/rear window, the windshield/rear window may be damaged by the force of the impact.

Mercedes-Benz recommends that you have the wiper blades changed at a qualified specialist workshop.

Changing the windshield wiper blades

Removing the wiper blades

- ▶ Remove the SmartKey from the ignition lock.
- ▶ Fold the wiper arm away from the windshield.

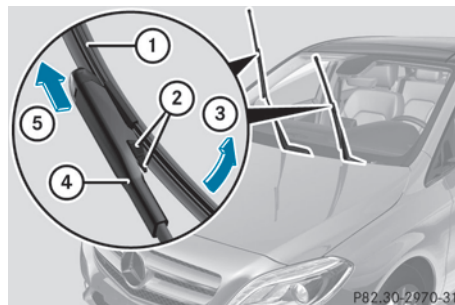

- ▶ Press both release clips ②.
- ▶ Fold wiper blade ① in the direction of arrow ③ away from wiper arm ④.
- ▶ Remove wiper blade ① in the direction of arrow ⑤.

Installing the wiper blades

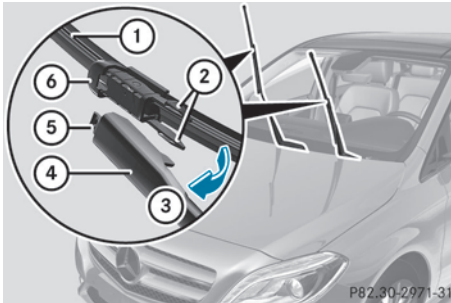

- ▶ Position new wiper blade ① with recess ⑥ on lug ⑤.
- ▶ Fold wiper blade ① in the direction of arrow ③ onto the wiper arm, until retaining clips ② engage in bracket ④.
- ▶ Make sure that wiper blade ① is seated correctly.
- ▶ Fold the wiper arm back onto the windshield.

Replacing the rear window wiper blade

WARNING

The wiper arm could be set in motion and injure you if the wiper is switched on. Remove the SmartKey from the ignition lock before replacing the wiper blade.

Removing a wiper blade

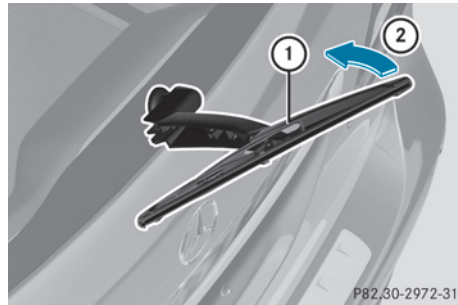

- ▶ Remove the SmartKey from the ignition lock.
- ▶ Fold wiper arm ① away from the rear window until it engages.
- ▶ Position wiper blade ② at a right angle to wiper arm ①.
- ▶ Hold wiper arm ① and press wiper blade ② in the direction of the arrow until it releases.
- ▶ Remove wiper blade ②.

Installing a wiper blade

- ▶ Place new wiper blade ② onto wiper arm ①.
- ▶ Hold wiper arm ① and press wiper blade ② in the opposite direction to the arrow until it engages.
- ▶ Make sure that wiper blade ② is seated correctly.
- ▶ Position wiper blade ② parallel to wiper arm ①.
- ▶ Fold wiper arm ① back onto the rear window.

Problems with the windshield wipers

The windshield wipers are obstructed

Leaves or snow, for example, may be obstructing the windshield wiper movement. The wiper motor has been deactivated.

- ▶ For safety reasons, you should remove the SmartKey from the ignition lock.
- ▶ Remove the cause of the obstruction.
- ▶ Switch the windshield wipers back on.

The windshield wipers are inoperative

The windshield wiper drive is malfunctioning.

- ▶ Select another wiper speed on the combination switch.
- ▶ Have the windshield wipers checked at a qualified specialist workshop.

The spray nozzles are misaligned

The windshield washer fluid from the spray nozzles no longer hits the center of the windshield. The spray nozzles are misaligned.

- ▶ Have the spray nozzles adjusted at a qualified specialist workshop.

Useful information	114
Overview of climate control systems	114
Operating the climate control systems	118
Setting the air vents	123

Useful information

- i** This Operator's Manual describes all models and all standard and optional equipment of your vehicle available at the time of publication of the Operator's Manual. Country-specific differences are possible. Please note that your vehicle may not be equipped with all features described. This also applies to safety-related systems and functions.
- i** Please read the information on qualified specialist workshops (▷ page 23).

- i** Ventilate the vehicle for a brief period during warm weather, e.g. using the convenience opening feature (▷ page 78). This will speed up the cooling process and the desired vehicle interior temperature will be reached more quickly.
- i** The integrated filter can filter out most particles of dust, and completely filters out pollen. A clogged filter reduces the amount of air supplied to the vehicle interior. For this reason, you should always observe the interval for replacing the filter, which is specified in the Maintenance Booklet. Since the replacement interval depends on environmental conditions, e.g. heavy air pollution, the interval may be shorter than stated in the Maintenance Booklet.

Overview of climate control systems

Important safety notes

WARNING

Observe the settings recommended on the following pages. The windows could otherwise fog up. This could prevent you from observing the traffic conditions, thereby causing an accident.

WARNING

Severe conditions (e.g. strong air pollution) may require replacement of the filter before its scheduled replacement interval. A clogged filter will reduce the air volume to the interior and the windows could fog up, impairing visibility and endangering you and others. Have a blocked filter replaced at a Mercedes-Benz Center as soon as possible.

The automatic climate control regulates the temperature and the humidity of the vehicle interior and filters out undesirable substances from the air.

Automatic climate control is only operational when the engine is running⁵. Optimum operation is only achieved if you drive with the side windows and panorama roof with power tilt/sliding panel closed.

⁵ Automatic climate control: the residual heat function can only be activated/deactivated when the ignition is switched off.

Control panel for dual-zone automatic climate control

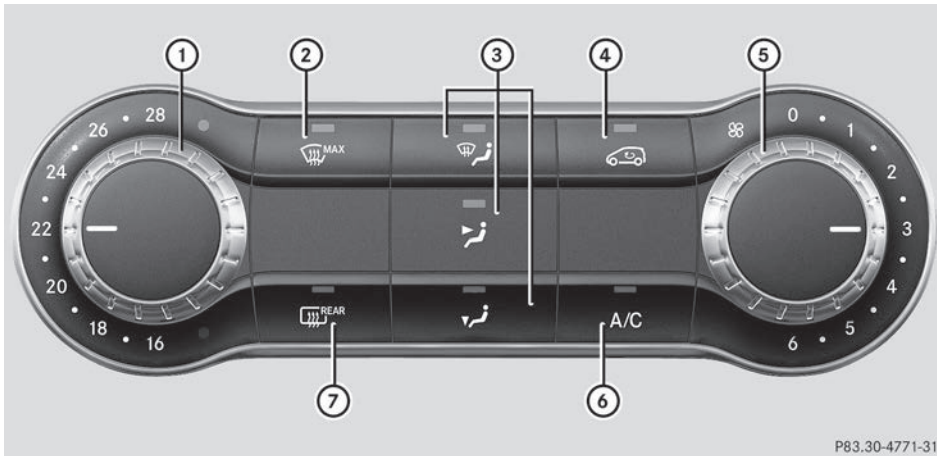









P83.30-4771-31

- ① Sets the temperature (▷ page 119)
- ② Defrosts the windshield (▷ page 121)
- ③ Sets the air distribution (▷ page 120)
- ④ Activates/deactivates air-recirculation mode (▷ page 122)
- ⑤ Sets the airflow (▷ page 120)
- ⑥ Activates/deactivates cooling with air dehumidification (▷ page 118)
- ⑦ Switches the rear window defroster on/off (▷ page 122)

Notes on using automatic climate control

The following contains notes and recommendations on optimum use of automatic climate control.

- Switch on the air-conditioning system by turning control knob ⑤ clockwise to the desired position (except position 0).
- Set the temperature to 22 °C.
- **Recommendation for preventing fogged up windows with low outside temperatures or rain:** switch  on for the air distribution and switch  and  off if possible (▷ page 120). In air-recirculation mode, switch  off (▷ page 122). Set airflow control ⑤ to a setting between 3 and 6 (▷ page 120).
- **Recommendation for rapid cooling or heating of the vehicle interior:** set airflow control ⑤ to a setting between 3 and 6 briefly (▷ page 120).
- **Recommendation for a constant vehicle interior temperature:** set airflow control ⑤ to a setting between 1 and 3 (▷ page 120).
- **Recommendation for air distribution in the winter:** set  and  (▷ page 120).
- **Recommendation for air distribution in the summer:** set  or  and  (▷ page 120).
- Only use the "defrosting" function briefly until the windshield is clear again.
- Only use "air-recirculation" mode briefly, e.g. if there are unpleasant outside odors or when in a tunnel. The windows could

otherwise fog up, since no fresh air is drawn into the vehicle in air-recirculation mode.

- If you change the settings of the climate control system, the climate status display appears for three seconds at the bottom of the screen in the COMAND display, see the separate COMAND Operating Instructions⁶. You will see the current settings of the various climate control functions.

⁶ Only if you have the "COMAND Multimedia System".

Control panel for 2-zone automatic climate control

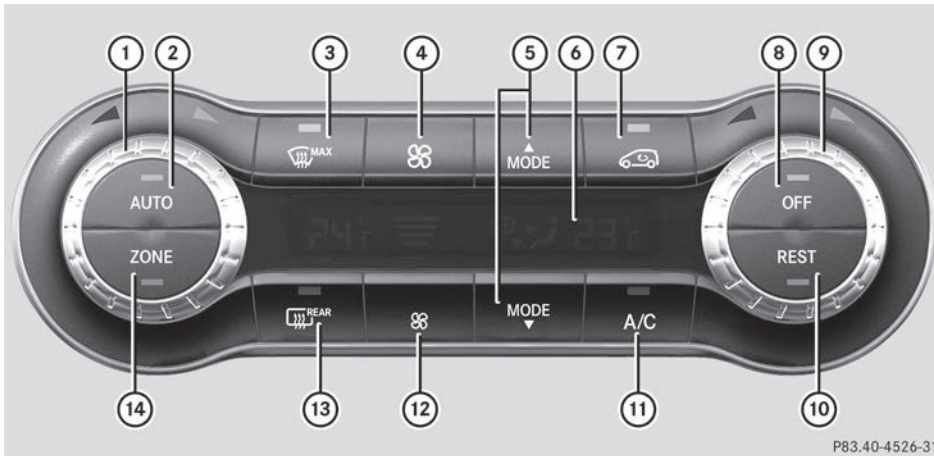

P83.40-4526-31

- ① Sets the temperature, left (▷ page 119)
- ② Sets climate control to automatic (▷ page 119)
- ③ Defrosts the windshield (▷ page 121)
- ④ Increases the airflow (▷ page 120)
- ⑤ Sets the air distribution (▷ page 120)
- ⑥ Display
- ⑦ Activates/deactivates air-recirculation mode (▷ page 122)
- ⑧ Switches climate control on/off (▷ page 118)
- ⑨ Sets the temperature, right (▷ page 119)
- ⑩ Activates/deactivates the residual heat function (▷ page 122)
- ⑪ Activates/deactivates cooling with air dehumidification (▷ page 118)
- ⑫ Reduces the airflow (▷ page 120)
- ⑬ Switches the rear window defroster on/off (▷ page 122)
- ⑭ Switches the ZONE function on/off (▷ page 120)

Notes on using automatic climate control

The following contains instructions and recommendations to enable you to get the most out of your automatic climate control.

- Activate climate control using the **AUTO** and **A/C** buttons. The indicator lamps in the **AUTO** and **A/C** buttons light up.
- Set the temperature to 22 °C.
- Only use the "defrosting" function briefly until the windshield is clear again.
- Only use "air-recirculation" mode briefly, e.g. if there are unpleasant outside odors or when in a tunnel. The windows could otherwise fog up, since no fresh air is drawn into the vehicle in air-recirculation mode.
- Use the ZONE function to adopt the temperature settings on the driver's side

for the front-passenger side as well. The indicator lamp in the **ZONE** button goes out.

- Use the residual heat function if you want to heat or ventilate the vehicle interior when the ignition is switched off. The "residual heat" function can only be activated or deactivated with the ignition switched off.

Operating the climate control systems

Activating/deactivating climate control

Points to observe before use

WARNING

When the climate control system is deactivated, the outside air supply and circulation are also deactivated. Only choose this setting for a short time. Otherwise the windows could fog up, impairing visibility and endangering you and others.

Activating/deactivating

Climate control

- ▶ Turn the SmartKey to position **2** in the ignition lock.
- ▶ **To switch on:** turn control **5** clockwise to the desired position (except position **0**) (▷ page 115).
- ▶ **To switch off:** turn control **5** counter-clockwise to position **0** (▷ page 115).

3-zone automatic climate control

- ▶ Turn the SmartKey to position **2** in the ignition lock.
- ▶ **To switch on:** press the **AUTO** button. The indicator lamp in the **AUTO** button lights up. Airflow and air distribution are set to automatic mode.

or

- ▶ Press the **OFF** button. The indicator lamp in the **OFF** button goes out. The previously selected settings are restored.
- ▶ **To switch off:** press button **OFF**. The indicator lamp in the **OFF** button lights up.

- i** 3-zone automatic climate control: switch on climate control primarily using the **AUTO** button.

Activating/deactivating cooling with air dehumidification

Points to observe before use

WARNING

If you switch off the cooling function, the vehicle will not be cooled when weather conditions are warm. The windows can fog up more quickly. This may prevent you from observing the traffic conditions, thereby causing an accident.





The cooling with air dehumidification function is only available with dual-zone automatic climate control and 3-zone automatic climate control.

The cooling with air dehumidification function is only available when the engine is running. The air inside the vehicle is cooled and dehumidified according to the temperature selected.

Condensation may drip from the underside of the vehicle when it is in cooling mode. This is normal and not a sign that there is a malfunction.

- i** The cooling with air dehumidification function uses refrigerant R134a. This refrigerant does not contain chlorofluorocarbons, and therefore does not damage the ozone layer.

Activating/deactivating

- ▶ **To activate:** press the  button. The indicator lamp in the  button lights up.
- ▶ **To deactivate:** press the  button. The indicator lamp in the  button goes out. The cooling with air dehumidification function has a delayed switch-off feature.

Problems with the cooling with air dehumidification function

When you press the  button, the indicator lamp in the button flashes three times or remains off. You can no longer switch on the cooling with air dehumidification function.

- ▶ Visit a qualified specialist workshop.

Setting climate control to automatic

WARNING



If you switch off the cooling function, the vehicle will not be cooled when weather conditions are warm. The windows can fog up more quickly. Window fogging may impair visibility and endanger you and others.

The automatic function is only available in conjunction with 3-zone automatic climate control.



In automatic mode, the set temperature is maintained automatically at a constant level. The system automatically regulates the temperature of the dispensed air, the airflow and the air distribution.

Automatic mode will achieve optimal operation if cooling with air dehumidification

is also activated. If desired, cooling with air dehumidification can be deactivated.

- ▶ Turn the SmartKey to position **2** in the ignition lock.
- ▶ Set the desired temperature.
- ▶ **To activate:** press the  button. The indicator lamp in the  button lights up. Automatic air distribution and airflow are activated.
- ▶ **To select manually:** press the  button.

or

- ▶ Press the  or  button. The indicator lamp in the  button goes out. Automatic air distribution and airflow are deactivated.

Setting the temperature



Climate control

You can set the temperature for the entire vehicle.

- ▶ Turn the SmartKey to position **2** in the ignition lock.
- ▶ **To increase/reduce:** turn control  clockwise or counter-clockwise (▷ page 115). Only change the temperature setting in small increments. Start at 22 °C.

3-zone automatic climate control



Different temperatures can be set for the driver's and front-passenger sides.

- ▶ Turn the SmartKey to position **2** in the ignition lock.
- ▶ **To increase/reduce:** turn control  or  clockwise or counter-clockwise (▷ page 117). Only change the temperature setting in small increments. Start at 22 °C.

Setting the air distribution





Air distribution settings

Climate control

-  Directs air through the defroster vents
-  Directs air through the center and side air vents
-  Directs the airflow through the footwell air vents



i You can also activate several air distribution settings simultaneously. To do this, press multiple air distribution buttons. The air is then directed through various vents.

3-zone automatic climate control



-  Directs air through the defroster vents
-  Directs air through the center and side air vents
-  Directs the airflow through the footwell air vents
-  Directs the airflow through the center and side air vents as well as the defroster vents
-  Directs air through the defroster and footwell vents

i Regardless of the air distribution setting, airflow is always directed through the side air vents. The side air vents can only be closed if the adjusters are turned clockwise as far as possible.

Climate control

- ▶ Turn the SmartKey to position **2** in the ignition lock.
- ▶ Press one or more of the , ,  buttons. The corresponding indicator lamp lights up briefly.

3-zone automatic climate control



- ▶ Turn the SmartKey to position **2** in the ignition lock.
- ▶ Press the  or  button until the desired symbol appears in the display.

Setting the airflow

Climate control





- ▶ Turn the SmartKey to position **2** in the ignition lock.
- ▶ **To increase/reduce:** turn control  clockwise or counter-clockwise (▷ page 115).

3-zone automatic climate control

- ▶ Turn the SmartKey to position **2** in the ignition lock.
- ▶ **To increase/reduce:** press the  or  button.

Switching the ZONE function on/off

This function is only available with 3-zone automatic climate control.



- ▶ **To activate:** press the  button. The indicator lamp in the  button lights up. The temperature setting for the driver's side is not adopted for the front-passenger side.
- ▶ **To deactivate:** press the  button. The indicator lamp in the  button goes out. The temperature setting for the driver's side is adopted for the front-passenger side.

Defrosting the windshield

You can use this function to defrost the windshield or to defrost the inside of the windshield and the side windows.

i You should only select the defrosting function until the windshield is clear again.

▶ Turn the SmartKey to position **2** in the ignition lock.



▶ **To activate:** press the  button. The indicator lamp in the  button lights up.



The climate control system switches to the following functions:

- high airflow
- high temperature
- air distribution to the windshield and front side windows
- air-recirculation mode off

i The "defrosting" function automatically sets the blower output to the optimum defrosting effect. As a result, the airflow may increase or decrease automatically after the button is pressed.

i You can manually adjust the blower output when the defrosting function is active.

- **Dual-zone automatic climate control:** turn airflow control  clockwise or counter-clockwise (▷ page 115).
- **3-zone automatic climate control:** press the  or  button.

▶ **To deactivate:** press the  button. The indicator lamp in the  button goes out. The previously selected settings are restored. Air-recirculation mode remains deactivated.



or

▶ Press the **AUTO** button⁷. The indicator lamp in the  button goes out. Airflow and air distribution are set to automatic mode.

⁷ 3-zone automatic climate control only.

or

▶ **Dual-zone automatic climate control:** turn temperature control  clockwise or counter-clockwise (▷ page 115).

3-zone automatic climate control: turn temperature controls  or  clockwise or counter-clockwise (▷ page 117).

Defrosting the windows

Windows fogged up on the inside

Climate control

▶ Activate the  cooling with air dehumidification function.

▶ If the windows continue to fog up, activate the defrosting function (▷ page 121).

i You should only select this setting until the windshield is clear again.

3-zone automatic climate control

▶ Activate the  cooling with air dehumidification function.

▶ Activate automatic mode **AUTO**.

▶ If the windows continue to fog up, activate the defrosting function (▷ page 121).

i You should only select this setting until the windshield is clear again.

Windows fogged up on the outside

▶ Activate the windshield wipers.

▶ Set the air distribution to  or .



i You should only select this setting until the windshield is clear again.

Rear window defroster

Activating/deactivating

WARNING

Clear all windows of ice or snow before setting off. Otherwise, impaired visibility could endanger you and others.

- ▶ Turn the SmartKey to position **2** in the ignition lock.
- ▶ Press the  button.
The indicator lamp in the  button lights up or goes out.

The rear window defroster has a high current draw. You should therefore switch it off as soon as the rear window is clear. Otherwise, the rear window defroster switches off automatically after several minutes.

If the battery voltage is too low, the rear window defroster may switch off.

Problems with the rear window defroster

The rear window defroster has deactivated prematurely or cannot be activated.

- ▶ Switch off any consumers that are not required, e.g. reading lamps or interior lighting.
When the battery is sufficiently charged, the rear window defroster can be activated again.



Activating/deactivating air-recirculation mode

WARNING

Only switch over to air-recirculation mode briefly at low outside temperatures. Otherwise, the windows could fog up, impairing visibility and endangering you and others. This may obstruct your view of the traffic situation and, as a result, you may cause an accident.



You can deactivate the flow of fresh air if unpleasant odors are entering the vehicle from outside. The air already inside the vehicle will then be recirculated.

The operation of air-recirculation mode is the same for all control panels.

- ▶ Turn the SmartKey to position **2** in the ignition lock.
- ▶ **To activate:** press the  button.
The indicator lamp in the  button lights up.

i Air-recirculation mode is activated automatically at high outside temperatures. When air-recirculation mode is activated automatically, the indicator lamp in the  button is not lit.

Outside air is added after about 30 minutes.

- ▶ **To deactivate:** press the  button.
The indicator lamp in the  button goes out.

i Air-recirculation mode deactivates automatically:

- after approximately five minutes at outside temperatures below approximately 5 °C
- after approximately five minutes if the cooling with air dehumidification function⁸ is switched off
- after approximately 30 minutes at outside temperatures above approximately 5 °C with the "Cooling with air dehumidification" function switched on⁸

Activating/deactivating the residual heat function

The residual heat function is only available with automatic climate control.

It is possible to make use of the residual heat of the engine to continue heating the

⁸ Only with dual-zone/3-zone automatic climate control.

stationary vehicle for up to 30 minutes after the engine has been switched off. The heating time depends on the temperature that has been set.

- i** The blower will run at a low speed regardless of the airflow setting.
- i** If you activate the residual heat function at high temperatures, only the ventilation will be activated. The blower runs at medium speed.
- ▶ Turn the SmartKey to position **0** in the ignition lock or remove it.
- ▶ **To activate:** press the **REST** button. The indicator lamp in the **REST** button lights up.
- ▶ **To deactivate:** press the **REST** button. The indicator lamp in the **REST** button goes out.
- i** Residual heat is deactivated automatically:
 - after approximately 30 minutes
 - when the ignition is switched on
 - if the battery voltage drops
 - when the auxiliary heating is activated

Setting the air vents

Important safety notes

WARNING

Very hot or very cold air can flow from the air vents. This could cause burns or frostbite to bare skin in the immediate vicinity of the vents. Keep bare skin away from these air vents. If necessary, direct the airflow away to a different area of the vehicle interior.

In order to ensure the direct flow of fresh air through the air vents into the vehicle interior, please observe the following notes:

- keep the air inlet between the windshield and the hood free of blockages, such as ice, snow or leaves.
- never cover the air vents or air intake grilles in the vehicle interior.
- i** You can move the adjusters for the air vents vertically or horizontally to set the direction of the airflow.
- i** For optimal climate control in the vehicle, open the air vents completely and set the adjusters to the central position.

Setting the center air vents

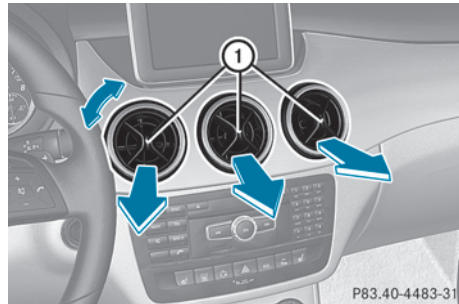

- ▶ **To open the center air vent:** turn the adjuster in one of center air vents **①** counter-clockwise.
- ▶ **To close the center air vent:** turn the adjuster in one of center air vents **①** clockwise until it engages.

Setting the side air vents

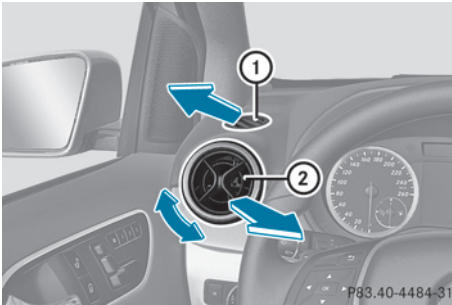

- ① Side window defroster vent
- ② Side air vent

- ▶ **To open a side air vent:** turn the adjuster in side air vent ② counter-clockwise.
- ▶ **To close a side air vent:** turn the adjuster in side air vent ② clockwise until it engages.

Setting the rear-compartment air vents

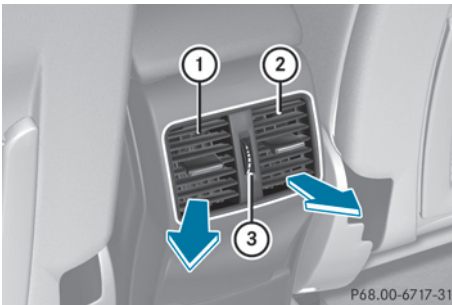

- ① Rear-compartment air vent, left
 - ② Rear-compartment air vent, right
 - ③ Rear-compartment air vent thumbwheel
- ▶ **To open/close:** turn thumbwheel ③ up or down.

Useful information	126
Breaking-in notes	126
Driving	126
Automatic transmission	132
Refueling	139
Parking	141
Driving tips	144
Driving systems	150

Useful information

- i** This Operator's Manual describes all models and all standard and optional equipment of your vehicle available at the time of publication of the Operator's Manual. Country-specific differences are possible. Please note that your vehicle may not be equipped with all features described. This also applies to safety-related systems and functions.
- i** Please read the information on qualified specialist workshops (▷ page 23).

Breaking-in notes

Important safety notes

New and replaced brake pads and discs only reach their optimum braking effect after several hundred kilometers of driving. Compensate for this by applying greater force to the brake pedal.

The first 1,000 miles (1,500 km)

The more you look after the engine when it is new, the more satisfied you will be with its performance in the future.

- You should therefore drive at varying vehicle and engine speeds for the first 1,000 miles (1,500 km).
- Avoid heavy loads, e.g. driving at full throttle, during this period.
- Change gear in good time, before the tachometer needle is $\frac{2}{3}$ of the way to the red area of the tachometer.
- Do not manually shift to a lower gear to brake the vehicle.
- If possible, do not depress the accelerator pedal past the point of resistance (kickdown).
- Ideally, for the first 1,000 miles (1,500 km), drive in program **E**.

After 1,000 miles (1,500km), you can increase the engine speed gradually and bring the vehicle up to full speed.

- i** You should also observe these breaking-in notes if the engine or parts of the drive train on your vehicle have been replaced.
- i** Always observe the respective speed limits.

Driving

Important safety notes

WARNING

Objects in the driver's footwell can restrict the pedal travel or obstruct a depressed pedal. The operating and road safety of the vehicle is jeopardized. There is a risk of an accident. Make sure that all objects in the vehicle are stowed correctly, and that they cannot enter the driver's footwell. Install the floormats securely and as specified in order to ensure sufficient clearance for the pedals. Do not use loose floormats.

WARNING

Unsuitable footwear can hinder correct usage of the pedals, e.g.:

- shoes with thick soles
- shoes with high heels
- slippers

There is a risk of an accident.

Wear suitable footwear to ensure correct usage of the pedals.

WARNING

If you switch off the ignition while driving, safety-relevant functions are only available with limitations, or not at all. This could affect, for example, the power steering and the brake boosting effect. You will require considerably more effort to steer and brake. There is a risk of an accident.

Do not switch off the ignition while driving.

⚠ WARNING

If the parking brake has not been fully released when driving, the parking brake can:

- overheat and cause a fire
- lose its hold function.

There is a risk of fire and an accident. Release the parking brake fully before driving off.

! Warm up the engine quickly. Do not use the engine's full performance until it has reached operating temperature.

Only shift the automatic transmission to the desired drive position when the vehicle is stationary.

Where possible, avoid spinning the drive wheels when pulling away on slippery roads. You could otherwise damage the drive train.

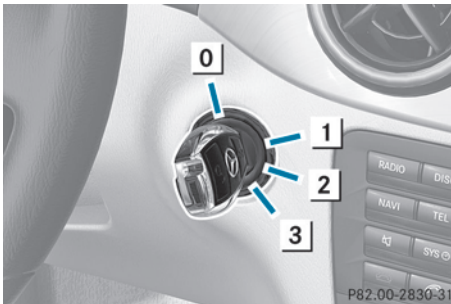
SmartKey positions

- 0** To remove the SmartKey (shift the transmission to position **P**)
 - 1** Power supply for some consumers, such as the windshield wipers
 - 2** Ignition (power supply for all consumers) and drive position
 - 3** To start the engine
- i** The SmartKey can be turned in the ignition lock even if it is not the correct SmartKey for the vehicle. The ignition is not switched on. The engine cannot be started.

Starting the engine**Important safety notes****⚠ WARNING**

Combustion engines emit poisonous exhaust gases such as carbon monoxide. Inhaling these exhaust gases leads to poisoning. There is a risk of fatal injury. Therefore never leave the engine running in enclosed spaces without sufficient ventilation.

! Do not depress the accelerator pedal when starting the engine.

i During a cold start, the engine runs at higher speeds to enable the catalytic converter to reach its operating temperature. The sound of the engine may change during this time.

Automatic transmission

► Shift the transmission to position **P**. Transmission position display **P** is shown in the multifunction display.

i When the transmission is in position **N**, you can also start the engine with the brake pedal depressed.

Starting procedure

► Turn the SmartKey to position **3** in the ignition lock (► page 127) and release it as soon as the engine is running.

Pulling away**Automatic transmission**

i It is only possible to shift the transmission from position **P** to the desired position if you depress the brake pedal. Only then can the parking lock be deactivated. If you do not depress the brake pedal, the DIRECT SELECT lever can still be moved but the parking lock remains engaged.

i If the transmission oil temperature is below -4 °F (-20 °C), you can only shift from position **P** when the engine is running.

- ▶ Depress the brake pedal and keep it depressed.
- ▶ Shift the transmission to position **D** or **R**.
- ▶ Release the brake pedal.
- ▶ Carefully depress the accelerator pedal. The electric parking brake (▷ page 142) is automatically released.

The red  indicator lamp in the instrument cluster goes out.

i The vehicle locks centrally once you have pulled away. The locking knobs in the doors drop down.

You can open the doors from the inside at any time.

You can also deactivate the automatic locking feature (▷ page 191).

i Upshifts take place at higher engine speeds after a cold start. This helps the catalytic converter to reach its operating temperature more quickly.

Hill start assist

WARNING

After a short time, hill start assist will no longer brake your vehicle and it could roll away. There is a risk of an accident and injury. Therefore, quickly move your foot from the brake pedal to the accelerator pedal. Never leave the vehicle when it is held by hill start assist.

Hill start assist helps you when pulling away forwards or in reverse on an uphill gradient. It holds the vehicle for a short time after you have removed your foot from the brake pedal. This gives you enough time to move your foot from the brake pedal to the accelerator pedal and to depress it before the vehicle begins to roll.

- ▶ Take your foot off the brake pedal. The vehicle is then held for about a second.
- ▶ Pull away.

Hill start assist will not function if:

- you are pulling away on a level road or on a downhill gradient.
- the transmission is in position **N**.
- the electric parking brake is applied.
- ESP® is malfunctioning.

ECO start/stop function

Important safety notes

WARNING

If the engine is switched off automatically and you exit the vehicle, the engine is restarted automatically. The vehicle may begin moving. There is a risk of accident and injury.

If you wish to exit the vehicle, always turn off the ignition and secure the vehicle against rolling away.

General notes

If the  symbol is shown in the multifunction display, the ECO start/stop function switches the engine off automatically when the vehicle stops.

The engine starts automatically when the driver wants to pull away again. The ECO start/stop function thereby helps you to reduce the fuel consumption and emissions of your vehicle.

The stop/start function is automatically activated each time you start the engine with the SmartKey.

If the ECO start/stop function has been manually deactivated (▷ page 130) or a malfunction has caused the system to be deactivated, the  symbol is not displayed.

Automatic engine switch-off

General notes

The ECO start/stop function is operational and the **ECO** symbol is displayed in the multifunction display, if:

- the indicator lamp in the ECO button is lit green.
- the outside temperature is within the comfort range.
- the engine is at normal operating temperature.
- the set temperature for the vehicle interior has been reached.
- the battery is sufficiently charged.
- the system detects that the windshield is not fogged up when the air-conditioning system is switched on.
- the hood is closed.
- the driver's door is closed and the driver's seat belt is fastened.

If conditions for automatic engine switch-off have not been fulfilled, the **ECO** symbol will not be shown.

- i** All of the vehicle's systems remain active when the engine has been stopped automatically.
- i** The engine can be switched off automatically a maximum of four times (first stop and three subsequent stops) in succession. Automatic engine switch-off is possible again once the ECO symbol appears in the multifunction display.
- i** During automatic engine switch-off, the climate control system only operates at a reduced capacity. If you require full climate control capacity, the ECO start/stop function can be deactivated by pressing the ECO button (> page 130).

Vehicles with automatic transmission

If the vehicle is braked to a standstill in **D** or **N**, the ECO start/stop function switches off the engine automatically.

- i** You can still activate the HOLD function when the vehicle is stationary, even if the engine has been switched off automatically. It is then not necessary to continue applying the brakes during the automatic stop phase. When you depress the accelerator pedal, the engine starts automatically and the braking effect of the HOLD function is deactivated. Depress the accelerator pedal carefully, as the engine must be started first.

Automatic engine start

General notes

The engine starts automatically if:

- you switch off the ECO start/stop function by pressing the ECO button.
- you engage reverse gear **R**.
- the vehicle starts to roll.
- the brake system requires this.
- the temperature in the vehicle interior deviates from the set range.
- the system detects moisture on the windshield when the air-conditioning system is switched on.
- the charge level of the battery is too low.
- the driver's seat belt is removed or the driver's door is opened.

Vehicles with automatic transmission

The engine is started automatically if you:

- release the brake pedal when HOLD is not activated and the transmission is in position **D** or **N**
- depress the accelerator pedal
- move the transmission out of position **P**.
- i** Shifting the transmission to position **P** does not start the engine.
- i** If you shift the transmission from **R** to **D**, the ECO start/stop function is available again as soon as the **ECO** symbol reappears in the multifunction display.

Deactivating/activating the ECO start/stop function

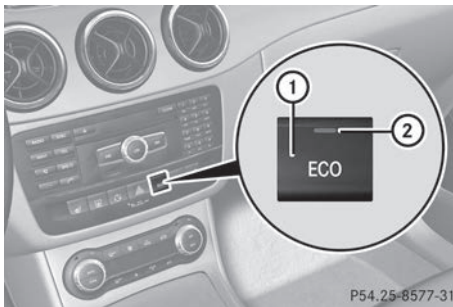

ECO button

- ▶ **To switch off:** press button ①.
Indicator lamp ② on button ① and the **ECO** symbol in the multifunction display go out.
 - ▶ **To switch on:** press button ①.
Indicator lamp ② lights up.
If all conditions for automatic engine switch-off are fulfilled, the **ECO** symbol is shown in the multifunction display.
If not all conditions for automatic engine switch-off are fulfilled, the **ECO** symbol is not shown in the multifunction display. If this is the case, the ECO start/stop function is not available.
- ❗ If indicator lamp ② is off, the ECO start/stop function has been deactivated manually or as the result of a malfunction. The engine will then not be switched off automatically when the vehicle stops.
 - ❗ The ECO start/stop function is activated each time the engine is switched on.

Problems with the engine

Problem	Possible causes/consequences and ► Solutions
The engine does not start.	<p>The HOLD function or DISTRONIC PLUS is activated.</p> <ul style="list-style-type: none"> ► Deactivate the HOLD function (▷ page 160) or DISTRONIC PLUS (▷ page 152). ► Try to start the engine again.
The engine does not start. The starter motor can be heard.	<ul style="list-style-type: none"> • There is a malfunction in the engine electronics. • There is a malfunction in the fuel supply. <ul style="list-style-type: none"> ► Turn the SmartKey back to position 0 in the ignition lock before attempting to start the engine again. ► Try to start the engine again (▷ page 127). Avoid excessively long and frequent attempts to start the engine as these will drain the battery. <p>If the engine does not start after several attempts:</p> <ul style="list-style-type: none"> ► Consult a qualified specialist workshop.
The engine does not start. You cannot hear the starter motor.	<p>The on-board voltage is too low because the battery is too weak or discharged.</p> <ul style="list-style-type: none"> ► Jump-start the vehicle (▷ page 283). <p>If the engine does not start despite attempts to jump-start it:</p> <ul style="list-style-type: none"> ► Consult a qualified specialist workshop, e.g. an authorized Mercedes-Benz Center. <p>The starter motor was exposed to a thermal load that was too high.</p> <ul style="list-style-type: none"> ► Allow the starter motor to cool down for approximately two minutes. ► Try to start the engine again. <p>If the engine still does not start:</p> <ul style="list-style-type: none"> ► Consult a qualified specialist workshop.

Problem	Possible causes/consequences and ► Solutions
The engine is not running smoothly and is misfiring.	<p>There is a malfunction in the engine electronics or in a mechanical component of the engine management system.</p> <ul style="list-style-type: none"> ► Only depress the accelerator pedal slightly. ► Have the cause rectified immediately at a qualified specialist workshop. Otherwise, non-combusted fuel may get into the catalytic converter and damage it.
The coolant temperature display is showing more than 248 °F (120 °C). The coolant warning lamp may also be lit and a warning tone may sound.	<p>The coolant level is too low. The coolant is too hot and the engine is no longer being cooled sufficiently.</p> <ul style="list-style-type: none"> ► Stop as soon as possible and allow the engine and the coolant to cool down. ► Check the coolant level (> page 263). Observe the warning notes as you do so and add coolant if necessary.

Automatic transmission

Important safety notes

WARNING

If the engine speed is above the idling speed and you engage transmission position **D** or **R**, the vehicle could pull away suddenly. There is a risk of an accident.

When engaging transmission position **D** or **R**, always firmly depress the brake pedal and do not simultaneously accelerate.

WARNING

The automatic transmission switches to neutral position **N** when you switch off the engine. The vehicle may roll away. There is a risk of an accident.

After switching off the engine, always switch to parking position **P**. Prevent the parked vehicle from rolling away by applying the parking brake.

WARNING

The clutch may overheat if you hold the vehicle stationary on uphill gradients by

depressing the accelerator pedal. If the clutch does overheat, a warning tone sounds and a display message is shown in the multifunction display. The frictional connection of the clutch may then be interrupted. The vehicle may roll away. As a result, you could cause an accident.

You will only be able to continue your journey once the clutch has cooled down and the display message in the multifunction display has disappeared.

Never hold the vehicle stationary on uphill gradients by depressing the accelerator. Instead, only ever hold the vehicle stationary on uphill gradients by:

- depressing the brake pedal
or
- activating the HOLD function
or
- engaging the electric parking brake

DIRECT SELECT lever**Overview of transmission positions**

The DIRECT SELECT lever is on the right of the steering column.

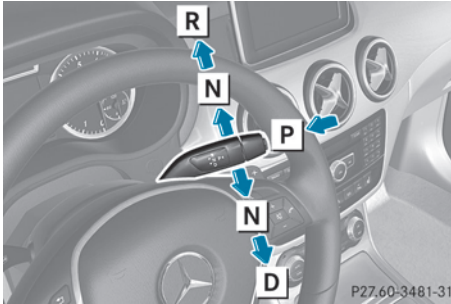

- P** Park position with parking lock
- R** Reverse gear
- N** Neutral
- D** Drive

- i** The DIRECT SELECT lever always returns to its original position. The current transmission position **P**, **R**, **N** or **D** appears in the transmission position display (> page 133) in the multifunction display.

Transmission position and drive program display

The current transmission position and drive program appear in the multifunction display.



- ① Transmission position display
- ② Drive program display

- i** The arrows in the transmission position display show how and into which transmission positions you can change using the DIRECT SELECT lever.

- !** If the transmission position display in the multifunction display is not working, you should pull away carefully to check whether the desired transmission position is engaged. Ideally, you should select transmission position **D** and drive program **E** or **S**.

Engaging park position P

- ▶ Push the DIRECT SELECT lever in the direction of arrow **P**. Transmission position display **P** is shown in the multifunction display.

- i** When you engage park position **P**, make sure that the transmission position display shows **P** in the multifunction display.

- i** You can only engage park position **P** when the vehicle is stationary.

- i** The automatic transmission shifts into park position **P** automatically:

- if you open the driver's door while the vehicle is stationary in transmission position **D** or **R**
- if you open the door while traveling at very low speeds in transmission position **D** or **R**

In addition, a warning tone sounds and a display message is shown.

- i** Depressing the brake and pushing the DIRECT SELECT lever up or down disengages the parking lock. The transmission is in **N** neutral.

If the transmission oil temperature is below -4°F (-20°C), you can only shift from park position **P** when the engine is running.

In order to shift from park position **P** directly into **R** or **D**:

- depress the brake pedal and
- push the DIRECT SELECT lever up or down past the first point of resistance

- !** If the engine speed is too high or the vehicle is moving, do not shift the

automatic transmission directly from **D** to **R**, from **R** to **D** or directly to **P**. The automatic transmission could otherwise be damaged.

Engaging reverse gear R

! Only shift the automatic transmission to **R** when the vehicle is stationary.

i The ECO start/stop function is not available when reverse gear is engaged. Further information on the ECO start/stop function (▷ page 128).

- ▶ When the vehicle is stationary, depress the brake pedal.
- ▶ Push the DIRECT SELECT lever up past the first point of resistance.

Shifting to neutral N

- ▶ When the vehicle is stationary, depress the brake pedal.
- ▶ Push the DIRECT SELECT lever up or down to the first point of resistance.

If the engine has been switched off, the automatic transmission automatically switches to **N**.

Remaining in neutral N

If the automatic transmission is to remain in neutral **N**, e.g. for washing the vehicle in car washes with a towing device, please observe the following instructions:

⚠ WARNING

When leaving the SmartKey in the starter switch, do not leave children unattended in the vehicle. It is possible for children to switch on the ignition which could result in unsupervised use of vehicle equipment. Unsupervised use of vehicle equipment could result in an accident and/or serious personal injury.

- make sure that the ignition is switched on.
- when the vehicle is stationary, depress the brake pedal and keep it depressed.

- shift to neutral **N**.
- release the brake pedal.
- if the electric parking brake is engaged, release it.
- switch off the ignition and leave the SmartKey in the ignition lock.

Engaging drive position D

- ▶ When the vehicle is stationary, depress the brake pedal.
- ▶ Push the DIRECT SELECT lever down past the first point of resistance.

Transmission positions

P Park position

Do not shift the transmission into position **P** unless the vehicle is stationary (▷ page 141). The parking lock should not be used as a brake when parking. Always apply the electronic parking brake in addition to the parking lock in order to secure the vehicle.

If the vehicle electronics are malfunctioning, the transmission may be locked in position **P**.

Have the vehicle electronics checked immediately at a qualified specialist workshop.

R Reverse gear

Only shift the transmission to **R** when the vehicle is stationary.

N Neutral

No power is transmitted from the engine to the drive wheels.

Releasing the brakes will allow you to move the vehicle freely, e.g. to push it or tow it.

If ESP® is deactivated or faulty: only shift the transmission to position **N** if the vehicle is in danger of skidding, e.g. on icy roads.

When you switch off the engine, the automatic transmission automatically shifts into neutral **N**.

D Drive

The automatic transmission changes gear automatically. All forward gears are available.

Changing gear

The automatic transmission shifts to the individual gears automatically when it is in transmission position **D**. This automatic gearshifting behavior is determined by:

- the selected drive program (▷ page 135)
- the position of the accelerator pedal
- the road speed

Driving tips**Kickdown**

Use kickdown for maximum acceleration:

- ▶ Depress the accelerator pedal beyond the pressure point.
The transmission shifts to a lower gear depending on the engine speed.
- ▶ Ease off the accelerator pedal once the desired speed is reached.
The automatic transmission shifts back up.

Rocking the vehicle free

Shifting the transmission repeatedly between gears **D** and **R** may help to free the vehicle if it has become stuck in slush or snow. The vehicle's engine management restricts repeated shifting between gears up to a maximum speed of 5 mph (9 km/h). To shift back and forth between transmission positions **D** and **R**, move the selector lever up and down beyond the pressure point.

Working on the vehicle**⚠ WARNING**

When working on the vehicle, engage the electric parking brake and shift the automatic transmission into park position **P**. Otherwise, the vehicle could roll away and cause an accident and/or serious injuries.

Program selector button**General notes**

The program selector button allows you to choose between drive programs with different driving characteristics.



Example: program selector button

E Economy	Comfortable, economical driving
S Sport	Sporty driving style
M Manual	Manual gear shifting

Only change from automatic drive program **E** or **S** to manual drive program **M** when the vehicle is stationary.

► Press program selector button ① repeatedly until the letter for the desired gearshift program appears in the multifunction display.

- ① The automatic transmission shifts to automatic drive program **E** each time the engine is started.
- ② For further information on the automatic drive program, see (▷ page 136).

Steering wheel paddle shifters



- ① Left steering wheel paddle shifter (shifts down)
- ② Right steering wheel paddle shifter (shifts up)

In drive program **M**, you can change gear yourself using the steering wheel paddle shifters.

If you pull the left or right steering wheel paddle shifter when in automatic drive program **E** or **S**, the automatic transmission shifts into drive program **M** for a limited time. Depending on which paddle shifter is pulled, the automatic transmission immediately shifts into the next gear down or up.

- ① You can only change gear with the steering wheel paddle shifters when the transmission is in position **D**.

- ② For further information on the manual drive program, see (▷ page 136).

Automatic drive program

Drive program **E** is characterized by the following:

- comfort-oriented engine settings
- optimal fuel consumption resulting from the automatic transmission shifting up sooner
- the vehicle pulling away more gently in forward and reverse gears, unless the accelerator pedal is depressed fully
- increased sensitivity. This improves driving stability on slippery road surfaces, for example
- the automatic transmission shifting up sooner. This results in the vehicle being driven at lower engine speeds and the wheels being less likely to spin

Drive program **S** is characterized by the following:

- sporty engine settings
- the automatic transmission shifting up later
- the fuel consumption possibly being higher as a result of the later automatic transmission shift points

Manual drive program

Introduction

In manual drive program **M**, you can change gear yourself by using the steering wheel paddle shifters. For this, the transmission must be in position **D**. The gear currently selected and engaged is shown in the multifunction display.

Manual drive program **M** differs from drive programs **E** and **S** with regard to spontaneity, responsiveness and smoothness of gear changes.

Gear	Driving situations
3	You can use the engine's braking effect
2	To use the braking effect of the engine on downhill gradients and for driving: <ul style="list-style-type: none"> • on steep mountain roads • in mountainous terrain • in arduous conditions
1	To use the braking effect of the engine on extremely steep downhill gradients and on long downhill stretches

Switching on the manual drive program

Activating permanently

- ▶ Press the program selector button (> page 135) repeatedly until **M** appears in the multifunction display. Manual drive program **M** remains active until drive program **E** or **S** is engaged.

Activating temporarily

- ▶ Pull the right or left steering wheel paddle shifter (> page 136). **M** is shown in the multifunction display. Manual drive program **M** is temporarily active. Depending on which paddle shifter is pulled, the automatic transmission immediately shifts into the next gear down or up.

- i** When manual drive program **M** is activated via the steering wheel paddle shifters, the temporarily active manual drive program **M** will be deactivated automatically after a limited time, if the driving situation permits. In this case, the automatic transmission shifts into the automatic drive program that was last engaged, i.e. **E** or **S**. When driving on downhill gradients, the temporarily active manual drive program **M** will only be deactivated if the accelerator pedal is

depressed while the vehicle is rolling downhill.

Upshifting

- ▶ Pull the right-hand steering wheel paddle shifter (> page 136). The automatic transmission shifts up to the next gear.
- ▶ Shift up a gear when the **^** upshift symbol appears in the display instead of **M**.

- i** To prevent engine damage the automatic transmission shifts up automatically:
 - if the maximum engine speed on the currently engaged gear is reached and
 - you continue to accelerate.

Downshifting

- ▶ Pull the left-hand steering wheel paddle shifter (> page 136). The automatic transmission shifts down to the next gear.

- i** If you slow down or stop without shifting down, the automatic transmission automatically shifts down.

- i** For maximum acceleration, pull the left-hand steering wheel paddle shifter until the transmission selects the optimum gear for the current speed.

- i** If the engine exceeds the maximum engine speed when shifting down, the automatic transmission protects against engine damage by not shifting down.

Kickdown

You can also use kickdown for maximum acceleration in manual drive program **M**.

- ▶ Depress the accelerator pedal beyond the pressure point. The transmission shifts to a lower gear depending on the engine speed.
- ▶ Shift back up once the desired speed is reached.

- i** During kickdown, you cannot change gear using the steering wheel paddle shifters.
- i** If you apply full throttle, the automatic transmission shifts up to the next gear when the maximum engine speed is reached. This prevents the engine from overrevving.

Switching off the manual drive program

- ▶ Press the program selector button (▷ page 135) repeatedly until **E** or **S** appears in the multifunction display.

Deactivating the temporary manual drive program

- ▶ Pull and hold the right-hand steering wheel paddle shifter until the automatic transmission shifts into the last active automatic drive program: **E** or **S**.
- i** If manual drive program **M** is deactivated, the automatic transmission in automatic drive program **E** or **S** may shift from the current gear into a higher or lower gear. This is dependent on the position of the accelerator pedal, speed and load.

Problems with the transmission

Problem	Possible causes/consequences and ► Solutions
The transmission has problems shifting gear.	The transmission is losing oil. ► Have the transmission checked at a qualified specialist workshop immediately.
The acceleration ability is deteriorating. The transmission no longer shifts into all of the gears. Reverse gear can no longer be engaged.	The transmission is in emergency mode. ► Stop the vehicle. ► Shift the transmission to position P . ► Switch off the engine. ► Wait at least 10 seconds before restarting the engine. ► Shift the transmission to position D . ► Have the transmission checked at a qualified specialist workshop immediately.

Refueling

Important safety notes

WARNING

Fuel is highly flammable. If you handle fuel incorrectly, there is a risk of fire and explosion.

You must avoid fire, open flames, creating sparks and smoking. Switch off the engine and, if applicable, the auxiliary heating before refueling.

WARNING

Fuel is poisonous and hazardous to health. There is a risk of injury.

You must make sure that fuel does not come into contact with your skin, eyes or clothing and that it is not swallowed. Do not inhale fuel vapors. Keep fuel away from children.

If you or others come into contact with fuel, observe the following:

- Wash away fuel from skin immediately using soap and water.
- If fuel comes into contact with your eyes, immediately rinse them thoroughly with

clean water. Seek medical assistance without delay.

- If fuel is swallowed, seek medical assistance without delay. Do not induce vomiting.
- Immediately change out of clothing which has come into contact with fuel.

WARNING

Electrostatic buildup can create sparks and ignite fuel vapors. There is a risk of fire and explosion.

Touch the vehicle body immediately before opening the fuel filler cap. Any existing electrostatic buildup is thereby discharged.

- ! Do not use diesel to refuel vehicles with a gasoline engine. Do not switch on the ignition if you accidentally refuel with the wrong fuel. Otherwise, the fuel will enter the fuel system. Even small amounts of the wrong fuel could result in damage to the fuel system and the engine. The repair costs are high. Notify a qualified specialist workshop and have the fuel tank and fuel lines drained completely.

- ❗ Overfilling the fuel tank could damage the fuel system.
- ❗ Take care not to spill any fuel on painted surfaces. You could otherwise damage the paintwork.
- ❗ Use a filter when refueling from a fuel can. Otherwise, the fuel lines and/or injection system could be blocked by particles from the fuel can.

If you overfill the fuel tank, fuel could spray out when the fuel pump nozzle is removed. Further information on fuel and on fuel grades can be found in the "Fuel" section (▷ page 324).

Refueling

Opening/closing the fuel filler flap

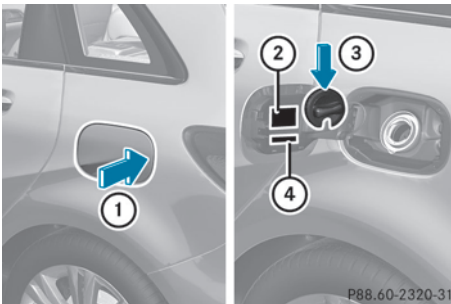

- ① To open the fuel filler flap
- ② Tire pressure table
- ③ To insert the fuel filler cap
- ④ Fuel type to be used

The fuel filler flap is unlocked or locked automatically when you open or close the vehicle with the SmartKey.

The position of the fuel filler cap is shown in the instrument cluster . The arrow on the filling pump indicates the side of the vehicle.

Opening

- ▶ Switch off the engine.
 - ▶ Remove the SmartKey from the ignition lock.
 - ▶ Press the fuel filler flap in the direction of arrow ①.
The fuel filler flap swings up.
 - ▶ Turn the fuel filler flap counter-clockwise and remove it.
 - ▶ Insert the fuel filler cap into the holder bracket on the inside of filler flap ③.
 - ▶ Completely insert the filler neck of the fuel pump nozzle into the tank and refuel.
 - ▶ Only fill the tank until the pump nozzle switches off.
- i** Do not add any more fuel after the pump stops filling for the first time. Otherwise, fuel may leak out.

Closing

- ▶ Replace the cap on the filler neck and turn clockwise until it engages audibly.
 - ▶ Close the fuel filler flap.
- i** Close the fuel filler flap before locking the vehicle.
- i** If you drive with the fuel filler cap open, the reserve fuel warning lamp flashes. In addition, the  Check Engine warning lamp may light up. A message appears in the multifunction display (▷ page 208). For further information on warning and indicator lamps in the instrument cluster, see (▷ page 226).

Problems with fuel and the fuel tank	
Problem	Possible causes/consequences and ► Solutions
Fuel is leaking from the vehicle.	<p>The fuel line or the fuel tank is faulty.</p> <p>⚠ WARNING</p> <p>Risk of explosion or fire.</p> <ul style="list-style-type: none"> ► Turn the SmartKey to position 0 in the ignition lock immediately and remove it (► page 127). ► Do not restart the engine under any circumstances. ► Consult a qualified specialist workshop.
The fuel filler flap cannot be opened.	<p>The fuel filler flap is not unlocked.</p> <p>or</p> <p>The SmartKey battery is discharged.</p> <ul style="list-style-type: none"> ► Unlock the vehicle (► page 68). <p>or</p> <ul style="list-style-type: none"> ► Unlock the vehicle using the mechanical key (► page 69).
	<p>The fuel filler flap is unlocked, but the opening mechanism is jammed.</p> <ul style="list-style-type: none"> ► Consult a qualified specialist workshop.

Parking

Important safety notes

⚠ WARNING

If flammable materials such as leaves, grass or twigs are exposed to prolonged contact to parts of the exhaust system that heat up, they could ignite. There is a risk of fire.

Park the vehicle so that no flammable materials come into contact with parts of the vehicle which are hot. Take particular care not to park on dry grassland or harvested grain fields.

⚠ WARNING

If you leave children unsupervised in the vehicle, they could set it in motion by, for example:

- releasing the parking brake
- shifting the automatic transmission out of the parking position **P**
- starting the engine.

They could also operate the vehicle's equipment. There is a risk of an accident and injury.

When leaving the vehicle, always take the SmartKey with you and lock the vehicle. Never leave children unsupervised in the vehicle.

! A moving vehicle can lead to damage to the vehicle or damage to the drive train.

To ensure that the vehicle is secured against rolling away unintentionally:

- the electric parking brake must be applied.
- the transmission must be in position **P** and the transmission position display must show **P**.
- the SmartKey must be removed from the ignition lock.
- on uphill or downhill gradients, the front wheels must be turned towards the curb.

Switching off the engine

Important safety notes

WARNING

The automatic transmission switches to neutral position **N** when you switch off the engine. The vehicle may roll away. There is a risk of an accident.

After switching off the engine, always switch to parking position **P**. Prevent the parked vehicle from rolling away by applying the parking brake.

Vehicles with automatic transmission

- ▶ Apply the electric parking brake.
 - ▶ Shift the transmission to position **P**.
 - ▶ Turn the SmartKey to position **0** in the ignition lock and remove it. The immobilizer is activated.
- i** If you switch the engine off with the transmission in position **R** or **D**, the automatic transmission shifts to **N** automatically.
- If you then open one of the front doors or remove the SmartKey from the ignition, the automatic transmission shifts to **P**.
- If you shift the automatic transmission to **N** before switching off the engine, the automatic transmission remains in **N** even if a door is opened.

- i** The automatic transmission shifts to **P** automatically if you:
- switch off the engine using the SmartKey and remove the SmartKey from the ignition lock or
 - switch off the engine using the SmartKey and open a front door.

If you attempt to turn off the engine when the selector lever is not in position **P**:

- a message appears in the multifunction display
- a warning signal sounds

Electric parking brake

General notes

WARNING

If you leave children unsupervised in the vehicle, they could set it in motion by, for example:

- releasing the parking brake
- shifting the automatic transmission out of the parking position **P**
- starting the engine.

They could also operate the vehicle's equipment. There is a risk of an accident and injury.

When leaving the vehicle, always take the SmartKey with you and lock the vehicle. Never leave children unsupervised in the vehicle.



- i** The electric parking brake performs a function test at regular intervals while the

engine is switched off. The sounds that can be heard while this is occurring are normal.

Applying/releasing manually

Applying

- ▶ Push handle ①.

When the electric parking brake is engaged, the  red indicator lamp lights up in the instrument cluster.

- i** The electric parking brake can also be applied when the SmartKey is removed.

Releasing

- ▶ Turn the SmartKey to position **1** in the ignition lock.
- ▶ Pull handle ①.

The red  indicator lamp in the instrument cluster goes out.

- i** The electric parking brake can only be released if the SmartKey is in position **1** in the ignition lock.

Applying automatically

The electric parking brake is applied automatically:

- if DISTRONIC PLUS brings the vehicle to a standstill or
- if the HOLD function is keeping the vehicle stationary

In addition, at least one of the following conditions must be fulfilled:

- the engine is switched off.
- the driver's door is open and the seat belt is not fastened.
- there is a system malfunction.
- the power supply is insufficient.
- the vehicle is stationary for a lengthy period.

The red  indicator lamp in the instrument cluster lights up.

- i** The electric parking brake is not automatically engaged if the engine is

switched off by the ECO start/stop function.

Releasing automatically

- i** The electric parking brake can only be released automatically on vehicles with automatic transmission.

Your vehicle's electric parking brake is automatically released if all of the following conditions are met:

- the engine is running.
- the transmission is in position **D** or **R**.
- the seat belt has been fastened.
- you depress the accelerator pedal.

If the transmission is in position **R**, the tailgate must be closed.

If your seat belt is not fastened, the following conditions must be fulfilled to automatically release the electric parking brake:

- the driver's door is closed.
- you shift out of position **P** or you have previously driven faster than 2 mph (3 km/h).

Emergency braking

The vehicle can also be braked during an emergency by using the electric parking brake.

- ▶ While driving, push handle ① of the electric parking brake (▷ page 142).

- i** The vehicle is braked for as long as handle ① of the electric parking brake is pressed. The longer electric parking brake handle ① is depressed, the greater the braking force.

During braking:

- a warning tone sounds.
- the **Please Release Parking Brake** message appears.
- the red  indicator lamp in the instrument cluster flashes.

When the vehicle has been braked to a standstill, the electric parking brake is engaged.

Parking the vehicle for a long period

If you leave the vehicle parked for longer than four weeks, the battery may be damaged by exhaustive discharging.

If you leave the vehicle parked for longer than six weeks, the vehicle may suffer damage as a result of lack of use.

- ▶ Visit a qualified specialist workshop and seek advice.

- ❗ You can obtain information about trickle chargers from a qualified specialist workshop.

Driving tips

General notes

Important safety notes

WARNING

Always remember that you must concentrate primarily on driving the vehicle. The driver's concentration must always be directed primarily at road traffic. For your own safety and that of others, we recommend that you stop the vehicle at a safe place and in accordance with the traffic conditions before making or accepting a phone call.

Comply with all legal requirements if you use the telephone while driving. Use the hands-free system and only use the telephone when road, weather and traffic conditions permit. In some jurisdictions, it is forbidden for drivers to use mobile phones while driving.

Only operate the audio system or COMAND (Cockpit Management and Data System) in compliance with all legal requirements and when the road, weather and traffic conditions permit. You may otherwise not be able to

observe the traffic conditions, endangering yourself and others.

Remember that your vehicle covers a distance of 44 ft (approximately 14 m) a second when it is traveling at only 30 mph (approximately 50 km/h).

WARNING

If you switch off the ignition while driving, safety-relevant functions are only available with limitations, or not at all. This could affect, for example, the power steering and the brake boosting effect. You will require considerably more effort to steer and brake. There is a risk of an accident.

Do not switch off the ignition while driving.

Drive sensibly – save fuel

Observe the following tips to save fuel:

- The tires should always be inflated to the recommended tire pressure.
- Remove unnecessary loads.
- Remove roof racks when they are not needed.
- Warm up the engine at low engine speeds.
- Avoid frequent acceleration or braking.
- Have all maintenance work carried out as indicated by the service intervals in the Maintenance Booklet or by the service interval display.

Fuel consumption also increases when driving in cold weather, in stop-and-go traffic and in mountainous terrain.

Drinking and driving

WARNING

Drinking and driving and/or taking drugs and driving are very dangerous combinations. Even a small amount of alcohol or drugs can affect your reflexes, perceptions and judgment.

The possibility of a serious or even fatal accident are greatly increased when you drink or take drugs and drive.

Do not drink or take drugs and drive or allow anyone to drive who has been drinking or taking drugs.

Exhaust check

WARNING

Combustion engines emit poisonous exhaust gases such as carbon monoxide. Inhaling these exhaust gases leads to poisoning. There is a risk of fatal injury. Therefore never leave the engine running in enclosed spaces without sufficient ventilation.

Certain engine systems are designed to keep the level of poisonous components in exhaust fumes within legal limits.

These systems only work at peak efficiency if they are serviced exactly in accordance with the manufacturer's specifications. For this reason, only have work on the engine carried out by qualified and authorized Mercedes-Benz technicians.

The engine settings must not be changed under any circumstances. Furthermore, all specific service work must be carried out at regular intervals and in accordance with the Mercedes-Benz service requirements. Details can be found in the Maintenance Booklet.

ECO display

The ECO display provides feedback on how economical your driving characteristics are. The ECO display assists you in achieving the most economical driving style for the selected settings and existing conditions. Consumption can be significantly influenced by your driving style.

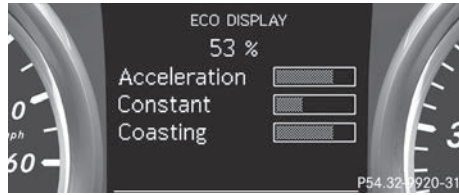

Example: ECO display

The ECO display consists of three bars:

- Acceleration
- Constant
- Coasting

The percentage count is the mean value of the three bar values. The three bars and the mean value begin at the value of 50%. A higher percentage count indicates a more economical driving style.

The ECO display does not indicate the actual fuel consumption. A fixed percentage count in the ECO display does not indicate a fixed consumption figure in mpg (l/100 km).

In addition to driving style, the consumption is affected by many other factors, such as:

- Load
- Tire pressure
- Cold start
- Choice of route
- The use of electrical consumers

These factors are not included in the ECO display.

The evaluation of your driving style takes the following three categories into consideration:

Acceleration (evaluation of all acceleration processes)

The bar fills up:	The bar empties:
Moderate acceleration, especially at higher speeds	Sporty acceleration

Smooth driving (assessment of driving behavior at all times)

The bar fills up:	The bar empties:
Constant speed and avoidance of unnecessary acceleration and deceleration	Fluctuations in speed

Coasting (assessment of all deceleration processes)

The bar fills up:	The bar empties:
Anticipatory driving, keeping your distance and early release of the accelerator: the vehicle can coast without use of the brakes	Frequent braking

- i** An economical driving style involves driving with a moderate engine speed. To achieve a higher value in the categories "acceleration" and "smooth driving":
 - observe the gearshift recommendation.
 - drive in drive program **E**.
- i** On long journeys at a constant speed, e.g. on the freeway, only the bar for "smooth driving" will change.
- i** The ECO display summarizes the driving characteristics from the start of the journey to its completion. Therefore, there are dynamic changes in the bars at the start of a journey. During a prolonged driving time, these changes are smaller. For dynamic changes, perform a manual reset.

Further information on the ECO display (> page 183).

Braking**Important safety notes****⚠ WARNING**

If you shift down on a slippery road surface in an attempt to increase the engine's braking effect, the drive wheels could lose their grip. There is an increased danger of skidding and accidents.

Do not shift down for additional engine braking on a slippery road surface.

Downhill gradients

- !** On long and steep gradients, you must reduce the load on the brakes by shifting to a lower gear in good time. This allows you to take advantage of the engine's braking effect. For this, you need to have selected manual drive program **M**. This helps you to avoid overheating the brakes and wearing them out excessively.

When you take advantage of the engine's braking effect, a drive wheel may not turn for some time, e.g. on a slippery road surface. This could cause damage to the drive train. This type of damage is not covered by the Mercedes-Benz warranty.

- i** Briefly depressing the accelerator pedal on downhill gradients while the manual drive program **M** is temporarily activated: the automatic transmission may switch to the last active automatic drive program **E** or **S**. The automatic transmission may shift to a higher gear. This can reduce the engine's braking effect.

Heavy and light loads**⚠ WARNING**

If you rest your foot on the brake pedal while driving, the braking system can overheat. This increases the stopping distance and can even cause the braking system to fail. There is a risk of an accident.

Never use the brake pedal as a footrest. Never depress the brake pedal and the accelerator pedal at the same time.

- ❗ Depressing the brake pedal constantly results in excessive and premature wear to the brake pads.

If the brakes have been subjected to a heavy load, do not stop the vehicle immediately. Drive on for a short while. This allows the airflow to cool the brakes more quickly.

Wet roads

If you have driven for a long time in heavy rain without braking, there may be a delayed reaction from the brakes when braking for the first time.

This may also occur after the vehicle has been driven through deep water.

You have to depress the brake pedal more firmly. Maintain a greater distance from the vehicle in front.

After driving on a wet road or having the vehicle washed, brake firmly while paying attention to the traffic conditions. This will warm up the brake discs, thereby drying them more quickly and protecting them against corrosion.

Limited braking performance on salt-treated roads

If you drive on salted roads, a layer of salt residue may form on the brake discs and brake pads. This can result in a significantly longer braking distance.

- Brake occasionally to remove any possible salt residue. Make sure that you do not endanger other road users when doing so.
- Carefully depress the brake pedal at the beginning and end of a journey.
- Maintain a greater distance to the vehicle ahead.

Servicing the brakes

- ❗ If the red brake warning lamp lights up in the instrument cluster and you hear a warning tone while the engine is running, the brake fluid level may be too low. Observe additional warning messages in the multifunction display.

The brake fluid level may be too low due to brake pad wear or leaking brake lines.

Have the brake system checked immediately. This work should be carried out at a qualified specialist workshop.

- ❗ A function or performance test should only be carried out on a 2-axle dynamometer. If you are planning to have the vehicle tested on such a dynamometer, contact an authorized Mercedes-Benz Center to obtain further information first. Otherwise, you could damage the drive train or the brake system.

- ❗ As the ESP[®] system operates automatically, the engine and the ignition must be switched off (the SmartKey must be in position **0** or **1** in the ignition lock) if:

- the electric parking brake is tested on a brake dynamometer (for a maximum of ten seconds)
- the vehicle is towed with the front axle raised.

Braking triggered automatically by ESP[®] may seriously damage the brake system.

All checks and maintenance work on the brake system must be carried out at a qualified specialist workshop. Consult a qualified specialist workshop to arrange this.

Have brake pads installed and brake fluid replaced at a qualified specialist workshop.

If the brake system has only been subject to moderate loads, you should test the functionality of your brakes at regular intervals. To do so, press firmly on the brake pedal when driving at a high speed. This improves the grip of the brake pads.

You can find a description of Brake Assist (BAS) on (▷ page 60).

Mercedes-Benz recommends that you only have brake pads/linings installed on your vehicle which have been approved for Mercedes-Benz vehicles or which correspond to an equivalent quality standard. Brake pads/linings which have not been approved for Mercedes-Benz vehicles or which are not of an equivalent quality could affect your vehicle's operating safety.

Mercedes-Benz recommends that you only use brake fluid that has been specially approved for your vehicle by Mercedes-Benz, or which corresponds to an equivalent quality standard. Brake fluid which has not been approved for Mercedes-Benz vehicles or which is not of an equivalent quality could affect your vehicle's operating safety.

Checking brake lining thickness

You can measure the brake pad/lining thickness using a test gauge. Color-coding (green or red) on the test gauge allows you to determine whether the brake pad/lining thickness is still sufficient. The test gauge is in the vehicle document wallet in the glove box.

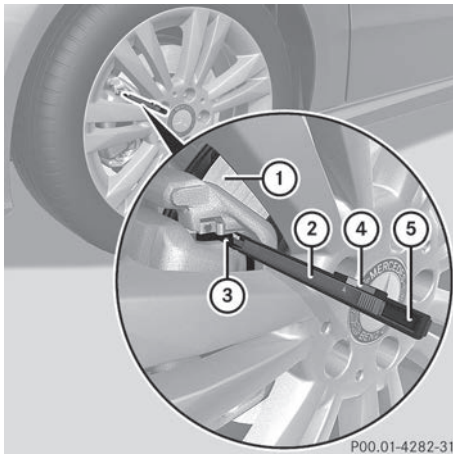

Front wheel

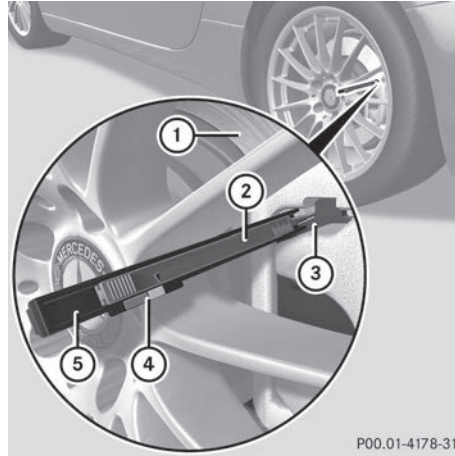

P00.01-4178-31

Rear wheel

- ▶ Bring the vehicle and wheels into a suitable position so that you can attach test gauge ⑤.
- ▶ Secure the vehicle against rolling away (▷ page 141).
- ▶ Move the selector lever to position **P**.
- ▶ Switch off the engine.
- ▶ Place test gauge ⑤ between the wheel's spokes on brake pad/lining ③.
- ▶ Hold test gauge ⑤ vertically on brake disc ① and slide measuring pin ② onto brake disc ①.
- ▶ Check which color field ④ the arrow on measuring pin ② is pointing to.
 - Green:** the brake pad/lining thickness is sufficient.

Red: the brake pad/lining thickness is not sufficient. Have the brake pads/lining checked at a qualified specialist workshop.

- i** To avoid an inaccurate measurement:
 - make sure you position the wheels suitably
 - do not put the measuring pin on a recess in the brake disc

Driving on wet roads

Hydroplaning

If water has accumulated to a certain depth on the road surface, there is a danger of hydroplaning occurring, even if:

- you drive at low speeds.
- the tires have adequate tread depth.

For this reason, in the event of heavy rain or in conditions in which hydroplaning may occur, you must drive in the following manner:

- lower your speed.
- avoid ruts.
- brake carefully.

Driving on flooded roads

! Do not drive through flooded areas. Check the depth of any water before driving through it. Drive slowly through standing water. Otherwise, water may enter the vehicle interior or the engine compartment. This can damage the electronic components in the engine or the automatic transmission. Water can also be drawn in by the engine's air suction nozzles and this can cause engine damage.

Winter driving

General notes

WARNING

If you shift down on a slippery road surface in an attempt to increase the engine's braking effect, the drive wheels could lose their grip. There is an increased danger of skidding and accidents.

Do not shift down for additional engine braking on a slippery road surface.

DANGER

If the exhaust pipe is blocked or adequate ventilation is not possible, poisonous gases

such as carbon monoxide (CO) may enter the vehicle. This is the case, e.g. if the vehicle becomes trapped in snow. There is a risk of fatal injury.

If you leave the engine or the auxiliary heating running, make sure the exhaust pipe and area around the vehicle are clear of snow. To ensure an adequate supply of fresh air, open a window on the side of the vehicle that is not facing into the wind.

Have your vehicle winterproofed at a qualified specialist workshop at the onset of winter.

Observe the notes in the "Winter operation" section (▷ page 294).

Driving with summer tires

Observe the notes in the "Winter operation" section (▷ page 294).

Slippery road surfaces

WARNING

If you shift down on a slippery road surface in an attempt to increase the engine's braking effect, the drive wheels could lose their grip. There is an increased danger of skidding and accidents.

Do not shift down for additional engine braking on a slippery road surface.

WARNING

The outside temperature indicator is not designed to serve as an ice-warning device and is therefore unsuitable for that purpose. Indicated temperatures just above the freezing point do not guarantee that the road surface is free of ice. The road may still be icy, especially in wooded areas or on bridges.

If the vehicle threatens to skid or cannot be stopped when moving at low speed:

- ▶ Shift the transmission to position **N**.

Drive particularly carefully on slippery road surfaces. Avoid sudden acceleration, steering

and braking maneuvers. Do not use the cruise control or DISTRONIC PLUS.

- i** For more information on driving with snow chains, see (▷ page 295).

Driving systems

Cruise control

Important safety notes

If you fail to adapt your driving style, cruise control can neither reduce the risk of an accident nor override the laws of physics. Cruise control cannot take into account the road, traffic and weather conditions. Cruise control is only an aid. You are responsible for the distance to the vehicle in front, for vehicle speed, for braking in good time and for staying in lane.

Do not use cruise control:

- in road and traffic conditions which do not allow you to maintain a constant speed e.g. in heavy traffic or on winding roads
- on slippery road surfaces. Braking or accelerating could cause the drive wheels to lose traction and the vehicle could then skid
- when there is poor visibility, e.g. due to fog, heavy rain or snow

If there is a change of drivers, advise the new driver of the speed stored.

General notes

Cruise control maintains a constant road speed for you. It brakes automatically in order to avoid exceeding the set speed. On long and steep downhill gradients, especially if the vehicle is laden, you must select a low gear in good time. For this, you will need to have selected manual drive program **M** (▷ page 146). By doing so, you will make use of the braking effect of the engine, which relieves the load on the brake system and prevents the brakes from overheating and wearing too quickly.

Use cruise control only if road and traffic conditions make it appropriate to maintain a steady speed for a prolonged period. You can store any road speed above 20 mph (30 km/h).

Cruise control lever

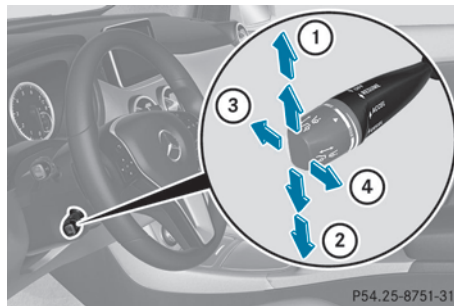

- ① To activate or increase speed
- ② To activate or reduce speed
- ③ To deactivate cruise control
- ④ To activate at the current speed/last stored speed

When you activate cruise control, the stored speed is shown in the multifunction display for five seconds.

In the multifunction display, the segments between the stored speed and the maximum speed light up.

Activation conditions

To activate cruise control, all of the following activation conditions must be fulfilled:

- you are driving faster than 20 mph (30 km/h).
- ESP® must be active, but not intervening.
- on vehicles with automatic transmission, the selector lever must be in position **D**.

Storing, maintaining and calling up a speed

Storing and maintaining the current speed

You can store the current speed if you are driving faster than 20 mph (30km/h).

- ▶ Accelerate the vehicle to the desired speed.
- ▶ Briefly press the cruise control lever up ① or down ②.
- ▶ Remove your foot from the accelerator pedal.
Cruise control is activated. The vehicle automatically maintains the stored speed.

i Cruise control may be unable to maintain the stored speed on uphill gradients. The stored speed is resumed when the gradient evens out. Cruise control maintains the stored speed on downhill gradients by automatically applying the brakes.

Storing the current speed or calling up the last stored speed

WARNING

If you call up the stored speed and it differs from the current speed, the vehicle accelerates or decelerates. If you do not know the stored speed, the vehicle could accelerate or brake unexpectedly. There is a risk of an accident.

Pay attention to the road and traffic conditions before calling up the stored speed. If you do not know the stored speed, store the desired speed again.

- ▶ Briefly pull the cruise control lever toward you ④.
- ▶ Remove your foot from the accelerator pedal.
The first time cruise control is activated, it stores the current speed or regulates the speed of the vehicle to the previously stored speed.

Setting a speed

Keep in mind that it may take a brief moment until the vehicle has accelerated or braked to the speed set.

- ▶ Press the cruise control lever up ① for a higher speed or down ② for a lower speed.
- ▶ **To adjust the set speed in 1 mph increments (1 km/h increments):** briefly press the cruise control lever up ① or down ② to the pressure point.
Every time the cruise control lever is pressed up ① or down ② the last speed stored is increased or reduced.
- ▶ **To adjust the set speed in 5 mph increments (10 km/h increments):** briefly press the cruise control lever up ① or down ② to the pressure point.
Every time the cruise control lever is pressed up ① or down ② the last speed stored is increased or reduced.

i Cruise control is not deactivated if you depress the accelerator pedal. For example, if you accelerate briefly to overtake, cruise control adjusts the vehicle's speed to the last speed stored after you have finished overtaking.

Deactivating cruise control

There are several ways to deactivate cruise control:

- ▶ Briefly press the cruise control lever forwards ③.

or

- ▶ Brake.

Cruise control is automatically deactivated if:

- you engage the electric parking brake.
- you are driving at less than 20 mph (30 km/h).
- ESP® intervenes or you deactivate ESP®.
- you shift the transmission to position **N** while driving.

If cruise control is deactivated, you will hear a warning tone. You will see the **Cruise Control Off** message in the multifunction display for approximately five seconds.

- When you switch off the engine, the last speed stored is cleared.

DISTRONIC PLUS

Important safety notes

WARNING

DISTRONIC PLUS does not react to:

- people or animals
- stationary obstacles on the road, e.g. stopped or parked vehicles
- oncoming and crossing traffic

As a result, DISTRONIC PLUS may neither give warnings nor intervene in such situations. There is a risk of an accident.

Always pay careful attention to the traffic situation and be ready to brake.

WARNING

DISTRONIC PLUS cannot always clearly identify other road users and complex traffic situations.

In such cases, DISTRONIC PLUS may:

- give an unnecessary warning and then brake the vehicle
- neither give a warning nor intervene
- accelerate unexpectedly

There is a risk of an accident.

Continue to drive carefully and be ready to brake, in particular when warned to do so by DISTRONIC PLUS.

WARNING

DISTRONIC PLUS brakes your vehicle with up to 40% of the maximum braking force. If this braking force is insufficient, DISTRONIC PLUS warns you visually and audibly. There is a risk of an accident.

In such cases, apply the brakes yourself and try to take evasive action.

- If DISTRONIC PLUS or the HOLD function is activated, the vehicle brakes automatically in certain situations. To prevent damage to the vehicle, deactivate DISTRONIC PLUS and the HOLD function in the following or other similar situations:

- when towing the vehicle
- in the car wash

If you fail to adapt your driving style, DISTRONIC PLUS can neither reduce the risk of accident nor override the laws of physics. DISTRONIC PLUS cannot take into account the road, traffic and weather conditions. DISTRONIC PLUS is only an aid. You are responsible for the distance to the vehicle in front, for vehicle speed, for braking in good time and for staying in lane.

Do not use DISTRONIC PLUS:

- in road and traffic conditions which do not allow you to maintain a constant speed e.g. in heavy traffic or on winding roads
- on slippery road surfaces. Braking or accelerating could cause the drive wheels to lose traction and the vehicle could then skid
- when there is poor visibility, e.g. due to fog, heavy rain or snow

DISTRONIC PLUS may not detect narrow vehicles driving in front, e.g. motorcycles, or vehicles driving on a different line.

In particular, the detection of obstacles can be impaired if there is:

- dirt on the sensors or anything else covering the sensors
- snow or heavy rain
- interference by other radar sources
- strong radar reflections, for example, in parking garages

If DISTRONIC PLUS no longer detects a vehicle in front, DISTRONIC PLUS may

unexpectedly accelerate the vehicle to the stored speed.

This speed may:

- be too high if you are driving in a filter lane or an exit lane
- be so high when driving in the right-hand lane that you overtake vehicles in the left-hand lane
- be so high when driving in the left-hand lane that you overtake vehicles in the right-hand lane

If there is a change of drivers, advise the new driver of the speed stored.

General notes

DISTRONIC PLUS regulates the speed and automatically helps you maintain the distance to the vehicle detected in front. DISTRONIC PLUS brakes automatically so that the set speed is not exceeded.

On long and steep downhill gradients, especially if the vehicle is laden, you must select a low gear in good time. For this, you will need to have selected manual drive program **M** (▷ page 146). By doing so, you will make use of the braking effect of the engine, which relieves the load on the brake system and prevents the brakes from overheating and wearing too quickly.

If DISTRONIC PLUS detects a slower-moving vehicle in front, your vehicle is braked in order to maintain the preset distance to the vehicle in front.

If DISTRONIC PLUS detects that there is a risk of a collision, you will be warned visually and acoustically. DISTRONIC PLUS cannot prevent a collision without your intervention. An intermittent warning tone will then sound and the distance warning lamp will light up in the instrument cluster. Brake immediately in order to increase the distance to the vehicle in front or take evasive action provided it is safe to do so.

DISTRONIC PLUS is automatically deactivated if:

- you are driving slower than 15 mph (25 km/h) and there is no vehicle in front or

- the vehicle in front is no longer detected

If there is no vehicle driving in front of you, DISTRONIC PLUS functions like cruise control at a speed range between 20 mph (30 km/h) and 120 mph (200 km/h). If a vehicle is driving in front of you, it operates in the speed range between 0 mph (0 km/h) and 120 mph (200 km/h).

Do not use DISTRONIC PLUS while driving on roads with steep gradients.

As DISTRONIC PLUS transmits radar waves, it can resemble the radar detectors of the responsible authorities. You can refer to the relevant chapter in the Operator's Manual if questions are asked about this.

- i** This device complies with the RSS-210 Rules of Industry Canada. Operation is subject to the following two conditions:

1. This device may not cause interference, and

2. this device must accept any interference received, including interference that may cause undesired operation of the device.

Removal, tampering, or altering of the device will void any warranties, and is not permitted. Do not tamper with, alter, or use the device in any non-approved way.

Any unauthorized modification to this device could void the user's authority to operate the equipment.

Cruise control lever

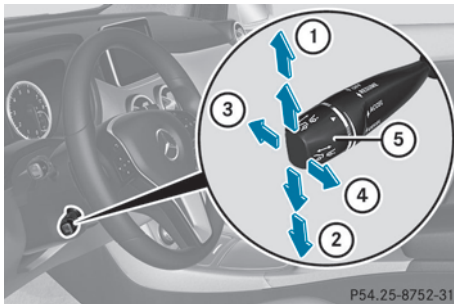

- ① To store the current speed or a higher speed
- ② To store the current speed or a lower speed
- ③ To deactivate DISTRONIC PLUS
- ④ To store the current speed or calling up the last stored speed
- ⑤ To set the specified minimum distance

Activating DISTRONIC PLUS; storing, maintaining and calling up a speed

Activation conditions

To activate DISTRONIC PLUS, all of the following activation conditions must be fulfilled:

- the engine must be started. It may take up to two minutes after pulling away before DISTRONIC PLUS is operational.
- the electric parking brake must be released.
- ESP® must be active, but not intervening.
- the transmission must be in position **D**.
- the driver's door must be closed when you shift from **P** to **D** or your seat belt must be fastened.
- the front-passenger door and rear doors must be closed.
- the vehicle must not skid.

Activating

To activate while driving: when driving at speeds below 14 mph (20 km/h), you can only activate DISTRONIC PLUS if the vehicle in front has been detected and is shown in the multifunction display. If the vehicle in front is no longer detected and displayed, DISTRONIC PLUS switches off and a tone sounds.

- ▶ Briefly pull the cruise control lever towards you ④, or press it up ① or down ②. DISTRONIC PLUS is selected.
- ▶ Press the cruise control lever repeatedly up ① or down ② until the desired speed is set.
- ▶ Remove your foot from the accelerator pedal. Your vehicle adapts its speed to that of the vehicle in front, but only up to the desired stored speed.

i If you do not fully release the accelerator pedal, the **DISTRONIC PLUS Passive** message appears in the multifunction display. The set distance to a slower-moving vehicle in front will then not be maintained. You will be driving at the speed you determine by the position of the accelerator pedal.

To activate when driving towards a stationary vehicle: if the vehicle in front is stationary, you can only activate DISTRONIC PLUS if your vehicle is also stationary.

- ▶ Briefly pull the cruise control lever towards you ④, or press it up ① or down ②. DISTRONIC PLUS is selected.
- i** DISTRONIC PLUS can only be activated at under 14 mph (20 km/h) if a vehicle in front has been detected. It is therefore helpful to have the DISTRONIC PLUS distance display activated in the multifunction display (▷ page 187).
- ▶ Press the cruise control lever repeatedly up ① or down ② until the desired speed is set.

- i** You can use the cruise control lever to set the stored speed and the control on the cruise control lever to set the specified minimum distance (▷ page 157).



DISTRONIC PLUS displays in the speedometer
When DISTRONIC PLUS is activated, one or two segments ② in the set speed range light up.

- i** For design reasons, the speed displayed in the speedometer may differ slightly from the speed set for DISTRONIC PLUS.

If DISTRONIC PLUS detects a vehicle in front, segments ② between speed of the vehicle in front ① and stored speed ③ light up.

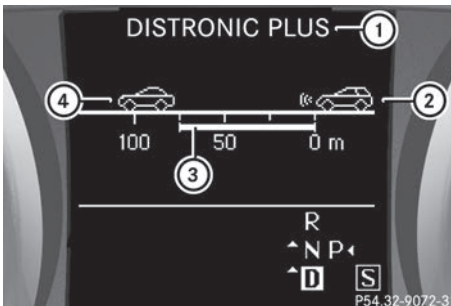

Distance display with DISTRONIC PLUS activated in the multifunction display

- ① DISTRONIC PLUS activated
- ② Own vehicle
- ③ Specified minimum distance to the vehicle in front; adjustable
- ④ Vehicle in front, if detected

In the Assistance menu (▷ page 187) of the on-board computer, you can select the distance display.

- ▶ Select the **Distance Display** function using the on-board computer (▷ page 187).

- i** You will see the stored speed for about five seconds when you activate DISTRONIC PLUS.

Driving

If you depress the brake, DISTRONIC PLUS is deactivated unless your vehicle is stationary.

Pulling away

- ▶ **If the vehicle in front pulls away:** remove your foot from the brake pedal.
- ▶ Briefly pull the cruise control lever (▷ page 154) towards you.

or

- ▶ Accelerate briefly.
Your vehicle pulls away and adapts its speed to that of the vehicle in front.

If there is no vehicle in front, DISTRONIC PLUS operates in the same way as cruise control.

If DISTRONIC PLUS detects that the vehicle in front has slowed down, it brakes your vehicle. In this way, the distance you have selected is maintained.

If DISTRONIC PLUS detects that the vehicle in front is driving faster, it accelerates your vehicle, but only up to the speed you have stored.

Changing lanes

If you change to the passing lane, DISTRONIC PLUS supports you when:

- you are driving faster than 40mph (60 km/h).
- DISTRONIC PLUS is maintaining the distance to a vehicle in front.
- you switch on the appropriate turn signal.
- DISTRONIC PLUS does not detect a danger of collision.

If these conditions are fulfilled, your vehicle is accelerated. Acceleration will be interrupted if changing lanes takes too long or if the distance between your vehicle and the vehicle in front becomes too small.

- i** When changing lanes, DISTRONIC PLUS monitors the left lane on left-hand drive vehicles and the right lane on right-hand drive vehicles.

Stopping

WARNING

When leaving the vehicle, even if it is braked only by DISTRONIC PLUS, it could roll away if:

- there is a malfunction in the system or in the voltage supply.
- DISTRONIC PLUS has been deactivated with the cruise control lever, e.g. by a vehicle occupant or from outside the vehicle.
- the electrical system in the engine compartment, the battery or the fuses have been tampered with.
- the battery is disconnected.
- the accelerator pedal has been depressed, e.g. by a vehicle occupant.

There is a risk of an accident.

If you wish to exit the vehicle, always turn off DISTRONIC PLUS and secure the vehicle against rolling away.

Deactivating DISTRONIC PLUS

(▷ page 157).

If DISTRONIC PLUS detects that the vehicle in front is stopping, it brakes your vehicle until it is stationary.

Once your vehicle is stationary, it remains stationary and you do not need to depress the brake.

- i** After a time, the electric parking brake secures the vehicle and relieves the service brake.
- i** Depending on the specified minimum distance, your vehicle will come to a

standstill at a sufficient distance behind the vehicle in front. The specified minimum distance is set using the control on the cruise control lever.

The electric parking brake automatically secures the vehicle if DISTRONIC PLUS is activated and:

- the driver's door is open and the driver's seat belt is unfastened.
- the engine is switched off, unless it is automatically switched off by the ECO start/stop function.
- a system malfunction occurs.
- the power supply is not sufficient.

If a malfunction occurs, then the transmission may be shifted into position **P** automatically.

Storing the current speed or calling up the last stored speed

WARNING

If you call up the stored speed and it differs from the current speed, the vehicle accelerates or decelerates. If you do not know the stored speed, the vehicle could accelerate or brake unexpectedly. There is a risk of an accident.

Pay attention to the road and traffic conditions before calling up the stored speed. If you do not know the stored speed, store the desired speed again.

- ▶ Briefly pull the cruise control lever (▷ page 154) towards you.
- ▶ Remove your foot from the accelerator pedal. DISTRONIC PLUS is activated. The first time it is activated, the current speed is stored. Otherwise, it sets the vehicle cruise speed to the previously stored value.

Setting a speed

WARNING

Keep in mind that it may take a brief moment until the vehicle has made the necessary adjustments.

Increase or decrease the set vehicle speed to a value that the prevailing road conditions and legal speed limits permit. Otherwise, sudden and unexpected acceleration or deceleration of the vehicle could cause an accident and/or serious injury to you and others.

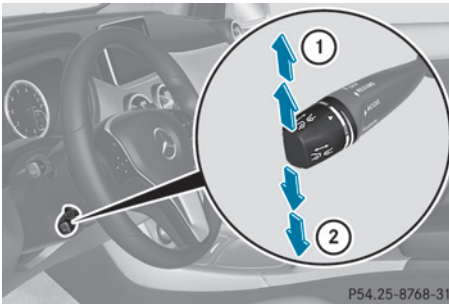

- ① To store the current speed or a higher speed
 - ② To store the current speed or a lower speed
- ▶ Press the cruise control lever up ① for a higher speed or down ② for a lower speed.

- ▶ **To adjust the set speed in 1 mph increments (1 km/h increments):** briefly press the cruise control lever up ① or down ② to the pressure point. Every time the cruise control lever is pressed up ① or down ② the last speed stored is increased or reduced.
- ▶ **To adjust the set speed in 5 mph increments (10 km/h increments):** briefly press the cruise control lever up ① or down ② to the pressure point. Every time the cruise control lever is pressed up ① or down ②, the last speed stored is increased or reduced.

- ❗ DISTRONIC PLUS is not deactivated if you depress the accelerator pedal. If you

accelerate to overtake, DISTRONIC PLUS adjusts the vehicle's speed to the last speed stored after you have finished overtaking.

Setting the specified minimum distance

You can set the specified minimum distance for DISTRONIC PLUS by varying the time span between one and two seconds. With this function, you can set the minimum distance that DISTRONIC PLUS keeps to the vehicle in front, dependent on vehicle speed. You can see this distance in the multifunction display (> page 155).

- ❗ Make sure that you maintain the minimum distance to the vehicle in front as required by law. Adjust the distance to the vehicle in front if necessary.

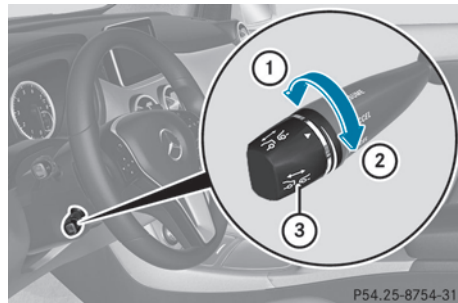

- ▶ **To increase:** turn control ③ in direction ②. DISTRONIC PLUS then maintains a greater distance between your vehicle and the vehicle in front.
- ▶ **To decrease:** turn control ③ in direction ①. DISTRONIC PLUS then maintains a shorter distance between your vehicle and the vehicle in front.

Deactivating DISTRONIC PLUS

WARNING

DISTRONIC PLUS is deactivated and releases the brakes if the vehicle is slowed down to a

speed below 14 mph (20 km/h) by the system, provided that DISTRONIC PLUS does not detect a vehicle directly ahead. At this point, the driver must apply the brakes in order to slow down further and bring the vehicle to a standstill.

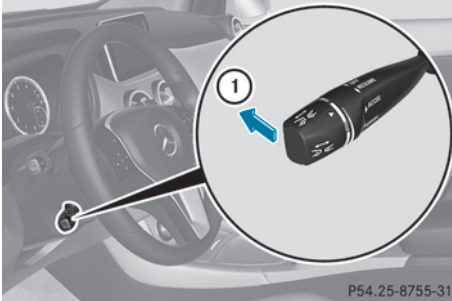

P54.25-8755-31

There are several ways to deactivate DISTRONIC PLUS:

- ▶ Briefly press the cruise control lever forwards ①.

or

- ▶ Brake, unless the vehicle is stationary.

When you deactivate DISTRONIC PLUS, you will see the **DISTRONIC PLUS Off** message in the multifunction display for approximately five seconds.

- ① The last speed stored remains stored until you switch off the engine.

DISTRONIC PLUS is automatically deactivated if:

- you engage the electric parking brake or if the vehicle is automatically secured with the electric parking brake.
- you are driving slower than 7 mph (10 km/h) and there is no vehicle in front, or if the vehicle in front is no longer detected.
- ESP® intervenes or you deactivate ESP®.
- the transmission is in the **P**, **R** or **N** position.
- you pull the cruise control lever towards you in order to pull away and the front-

passenger door or one of the rear doors is open.

- the vehicle has skidded.

If DISTRONIC PLUS is deactivated, you will hear a warning tone. You will see the **DISTRONIC PLUS Off** message in the multifunction display for approximately five seconds.

In the Assistance menu (▷ page 187) of the on-board computer, you can select the distance display.

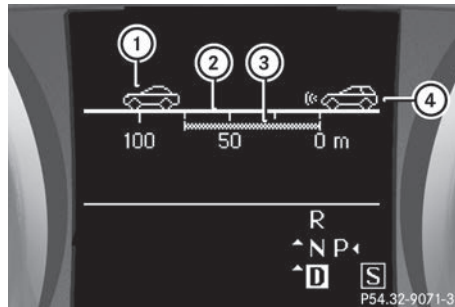

P54.32-9071-31

Distance display when DISTRONIC PLUS is deactivated

- ① Vehicle in front, if detected
- ② Distance indicator, current distance to the vehicle in front
- ③ Specified minimum distance to the vehicle in front; adjustable
- ④ Own vehicle

- ▶ Select the **Distance Display** function using the on-board computer (▷ page 187).

Tips for driving with DISTRONIC PLUS

General notes

The following contains descriptions of certain road and traffic conditions in which you must be particularly attentive. In such situations, brake if necessary. DISTRONIC PLUS is then deactivated.

Cornering, going into and coming out of a bend

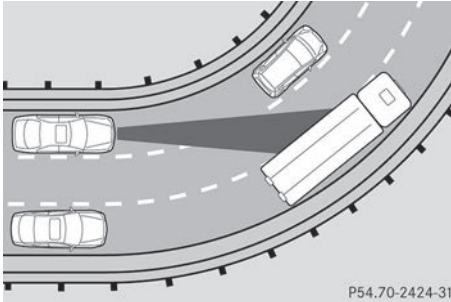

P54.70-2424-31

The ability of DISTRONIC PLUS to detect vehicles when cornering is limited. Your vehicle may brake unexpectedly or late.

Vehicles traveling on a different line

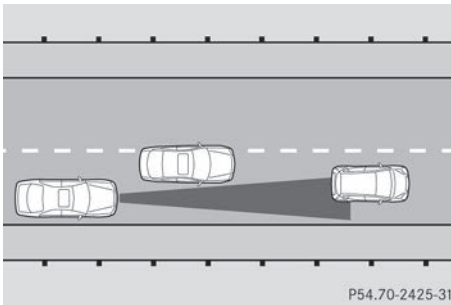

P54.70-2425-31

DISTRONIC PLUS may not detect vehicles traveling on a different line. The distance to the vehicle in front will be too short.

Other vehicles changing lanes

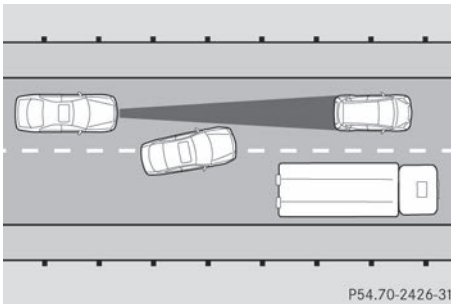

P54.70-2426-31

DISTRONIC PLUS has not detected the vehicle cutting in yet. The distance to this vehicle will be too short.

Narrow vehicles

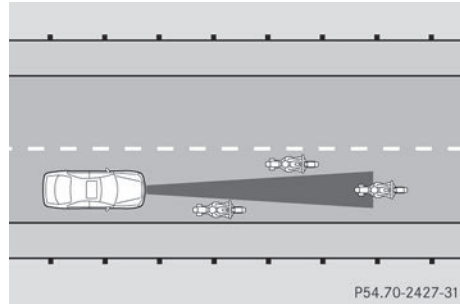

P54.70-2427-31

DISTRONIC PLUS has not yet detected the vehicle in front on the edge of the road, because of its narrow width. The distance to the vehicle in front will be too short.

Obstructions and stationary vehicles

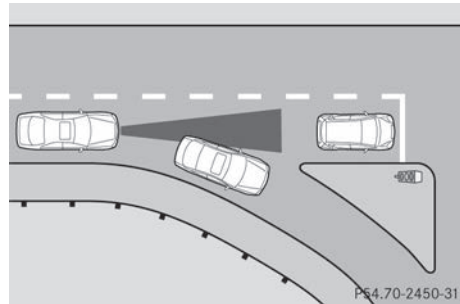

P54.70-2450-31

DISTRONIC PLUS does not brake for obstacles or stationary vehicles. If, for example, the detected vehicle turns a corner and reveals an obstacle or stationary vehicle, DISTRONIC PLUS will not brake for these.

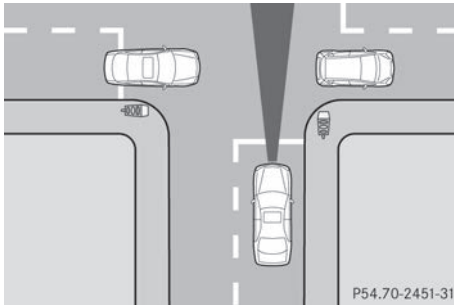
Crossing vehicles

DISTRONIC PLUS may detect vehicles that are crossing your lane by mistake. Activating DISTRONIC PLUS at traffic lights with crossing traffic, for example, could cause your vehicle to pull away unintentionally.

HOLD function**Important safety notes****⚠ WARNING**

When leaving the vehicle, it can still roll away despite being braked by the HOLD function if:

- there is a malfunction in the system or in the voltage supply.
- the HOLD function has been deactivated by pressing the accelerator pedal or the brake pedal, e.g. by a vehicle occupant.
- the electrical system in the engine compartment, the battery or the fuses have been tampered with.
- the battery is disconnected

There is a risk of an accident.

If you wish to exit the vehicle, always turn off the HOLD function and secure the vehicle against rolling away.

! If DISTRONIC PLUS or the HOLD function is activated, the vehicle brakes automatically in certain situations. To prevent damage to the vehicle, deactivate DISTRONIC PLUS and the HOLD function in the following or other similar situations:

- when towing the vehicle
- in the car wash

Deactivate the HOLD function (▷ page 161).

General notes

The HOLD function can assist the driver in the following situations:

- when pulling away, especially on steep slopes
- when maneuvering on steep slopes
- when waiting in traffic

The vehicle is kept stationary without the driver having to depress the brake pedal.

The braking effect is canceled and the HOLD function deactivated when you depress the accelerator pedal to pull away.

Activation conditions

You can activate the HOLD function if:

- the vehicle is stationary.
- the engine is running or if it has been automatically switched off by the ECO start/stop function.
- the driver's door is closed or your seat belt is fastened.
- the electric parking brake is released.
- the transmission position **D**, **R** or **N** is engaged while driving a vehicle with an automatic transmission.
- DISTRONIC PLUS is deactivated.

Activating the HOLD function

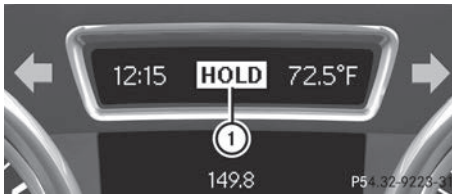

- ▶ Make sure that the activation conditions are met.
- ▶ Depress the brake pedal.
- ▶ Quickly depress the brake pedal further until ① appears in the multifunction display.
The HOLD function is activated. You can release the brake pedal.

i If depressing the brake pedal the first time does not activate the HOLD function, wait briefly and then try again.

Deactivating the HOLD function

The HOLD function is deactivated automatically if:

- you accelerate. On vehicles with automatic transmission: only when the transmission is in position **D** or **R**.
 - the transmission is in position **P** on vehicles with automatic transmission.
 - you depress the brake pedal again with a certain amount of pressure until ① disappears from the multifunction display.
 - you secure the vehicle using the electric parking brake.
 - you activate DISTRONIC PLUS.
- i** After a time, the electric parking brake secures the vehicle and relieves the service brake.

The electric parking brake automatically secures the vehicle if the HOLD function is activated and:

- the driver's door is open and the driver's seat belt is unfastened.
- the engine is switched off, unless it is automatically switched off by the ECO start/stop function.
- a system malfunction occurs.
- the power supply is not sufficient.

If a malfunction occurs, then the transmission may be shifted into position **P** automatically.

PARKTRONIC

Important safety notes

PARKTRONIC is only an aid. It is not a replacement for your attention to your immediate surroundings. You are always responsible for safe maneuvering, parking and exiting a parking space. When maneuvering, parking or pulling out of a parking space, make sure that there are no persons, animals or objects in the area in which you are maneuvering.

! When parking, pay particular attention to objects above or below the sensors, such as flower pots or trailer drawbars. PARKTRONIC does not detect such objects when they are in the immediate vicinity of the vehicle. You could damage the vehicle or the objects.

The sensors may not detect snow and other objects that absorb ultrasonic waves.

Ultrasonic sources such as an automatic car wash, the compressed-air brakes on a truck or a pneumatic drill could cause PARKTRONIC to malfunction.

PARKTRONIC may not function correctly on uneven terrain.

PARKTRONIC is an electronic parking aid with ultrasonic sensors. It indicates visually and audibly the distance between your vehicle and an object.

PARKTRONIC is activated automatically when you:

- switch on the ignition
- shift the transmission to position **D**, **R** or **N**
- release the electric parking brake

PARKTRONIC is deactivated at speeds above 11 mph (18 km/h). It is reactivated at lower speeds.

PARKTRONIC monitors the area around your vehicle using six sensors in the front bumper and four sensors in the rear bumper.

Range of the sensors

General notes

PARKTRONIC does not take objects into consideration that are:

- below the detection range, e.g. people, animals or objects
- above the detection range, e.g. overhanging loads, truck overhangs or loading ramps.

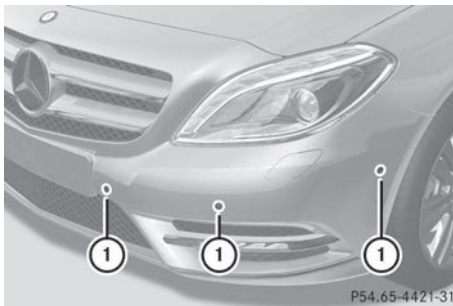

- ① Example: sensors in the front bumper, left-hand side



Side view

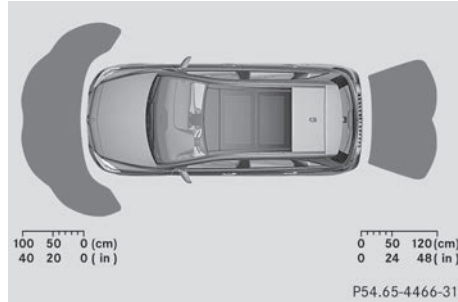

Top view

The sensors must be free of dirt, ice and slush. Otherwise, they may not function correctly. Clean the sensors regularly, taking care not to scratch or damage them (▷ page 269).

Front sensors

Center	Approx. 40 in (approx. 100 cm)
Corners	Approx. 24 in (approx. 60 cm)

Rear sensors

Center	Approx. 48 in (approx. 120 cm)
Corners	Approx. 32 in (approx. 80 cm)

Minimum distance

Center	Approx. 8 in (approx. 20 cm)
Corners	Approx. 8 in (approx. 20 cm)

If there is an obstacle within this range, the relevant warning displays light up and a warning tone sounds. If the distance falls below the minimum, the distance may no longer be shown.

Warning displays

The warning displays show the distance between the sensors and the obstacle. The warning display for the front area is located

on the dashboard above the center air vents. The warning display for the rear area is located on the headliner in the rear compartment.

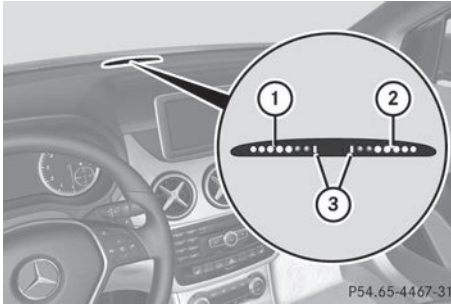

Warning display for the front area

- ① Segments on the left-hand side of the vehicle
- ② Segments on the right-hand side of the vehicle
- ③ Segments showing operational readiness

The warning display for each side of the vehicle is divided into five yellow and two red segments. PARKTRONIC is operational if yellow segments showing operational readiness ③ light up.

The selected transmission position and the direction in which the vehicle is rolling determine which warning display is active when the engine is running.

Transmission position	Warning display
D	Front area activated
R, N or the vehicle is rolling backwards	Rear and front areas activated
P	No areas activated

One or more segments light up as the vehicle approaches an obstacle, depending on the vehicle's distance from the obstacle.

From the:

- sixth segment onwards, you will hear an intermittent warning tone for approximately two seconds.
- seventh segment onwards, you will hear a warning tone for approximately two seconds. This indicates that you have now reached the minimum distance.

Deactivating/activating PARKTRONIC

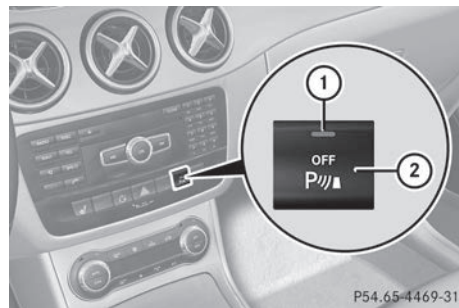

- ① Indicator lamp
- ② To deactivate/activate PARKTRONIC

If indicator lamp ① lights up, PARKTRONIC is deactivated.

- ❗ PARKTRONIC is automatically activated when you turn the SmartKey to position 2 in the ignition lock.

Problems with PARKTRONIC

Problem	Possible causes/consequences and ► Solutions
Only the red segments in the PARKTRONIC warning displays are lit. You also hear a warning tone for approximately two seconds. PARKTRONIC is deactivated after approximately 20 seconds, and the indicator lamp in the PARKTRONIC button lights up.	PARKTRONIC has malfunctioned and has switched off. ► If problems persist, have PARKTRONIC checked at a qualified specialist workshop.
Only the red segments in the PARKTRONIC warning displays are lit. PARKTRONIC is deactivated after approximately 20seconds.	The PARKTRONIC sensors are dirty or there is interference. ► Clean the PARKTRONIC sensors (▷ page 269). ► Switch the ignition back on. The problem may be caused by an external source of radio or ultrasound waves. ► See if PARKTRONIC functions in a different location.

Active Parking Assist

Important safety notes

Active Parking Assist is merely an aid. It is not a replacement for your attention to your immediate surroundings. You are always responsible for safe maneuvering, parking and exiting a parking space. When maneuvering, parking or pulling out of a parking lot, make sure that there are no persons, animals or objects in the area in which you are maneuvering.

 **WARNING**

The vehicle swings out when parking and in doing so could cross into the opposite lane. This could result in a collision with another road user. There is a risk of an accident. Pay attention to other road users when parking. Stop the vehicle if necessary or

cancel the Active Parking Assist parking procedure.

! If unavoidable, you should drive over obstacles such as curbs slowly and not at a sharp angle. Otherwise, you may damage the wheels or tires.

Active Parking Assist may possibly indicate parking spaces which are not suitable for parking, for example:

- where parking or stopping is prohibited
- in front of driveways or entrances and exits
- on unsuitable surfaces

Parking tips:

- on narrow roads, drive past the parking space as close as possible.
- parking spaces that are littered, overgrown or partially occupied by trailer drawbars might be identified incorrectly or not at all.
- snowfall or heavy rain may lead to a parking space being measured inaccurately.
- pay attention to the PARKTRONIC (> page 162) warning messages during the parking procedure.
- you can intervene in the steering procedure to correct it at any time. Active Parking Assist will then be canceled.
- when transporting a load which protrudes from your vehicle, you should not use Active Parking Assist.
- never use Active Parking Assist when snow chains are installed.
- make sure that the tire pressures are always correct. This has a direct influence on the parking characteristics of the vehicle.
- the way your vehicle is positioned in the parking space after parking is dependent on various factors. These include the position and shape of the vehicles parked in front and behind it and the conditions of the location. In some cases, Active Parking Assist may guide you too far into a parking space, or not far enough into it. In some cases, it may also lead you across or onto the curb. If necessary, you should abort the parking procedure with Active Parking Assist.
- you can also engage forward gear prematurely. The vehicle redirects and does not drive as far into the parking space. Should the gear change occur too soon to achieve a sensible parking position, the parking procedure will be aborted.

General notes

Active Parking Assist is an electronic parking aid with ultrasound. Ultrasound is used to measure the road on both sides of the vehicle. A suitable parking space is indicated by the parking symbol. Active steering intervention can assist you during parking.

You may also use PARKTRONIC (> page 161). When PARKTRONIC is switched off, Active Parking Assist is also unavailable. Use Active Parking Assist for parking spaces:

- that are parallel to the direction of travel
- that are on straight roads, not bends
- that are on the same level as the road, e.g. not on the pavement

Detecting a parking space

Objects located above the height range of Active Parking Assist will not be detected when the parking space is measured. These are not taken into account when the parking procedure is calculated, e.g. overhanging loads, tail sections or loading ramps of goods vehicles. In some circumstances, Active Parking Assist may therefore guide you into the parking space too early.

WARNING

If there are objects above the detection range, Active Parking Assist may turn prematurely. You may cause a collision as a result. There is a risk of an accident.

If there are objects above the detection range, stop and deactivate Active Parking Assist.

Active Parking Assist is automatically activated when driving forwards. The system is operational at speeds of up to approximately 22 mph (35 km/h). While in operation, the system independently locates and measures parking spaces on both sides of the vehicle. When driving at speeds below 19 mph (30 km/h), you will see the parking symbol as a status indicator in the instrument cluster. By default, Active Parking Assist only displays parking spaces on the front-

passenger side. Parking spaces on the driver's side are displayed as soon as the turn signal on the driver's side is activated. To park on the driver's side, you must leave the driver's side turn signal switched on. This must remain switched on until you acknowledge the use of Active Parking Assist by pressing the **OK** button on the multifunction steering wheel.

When a parking space has been detected, an arrow towards the right or the left also appears.

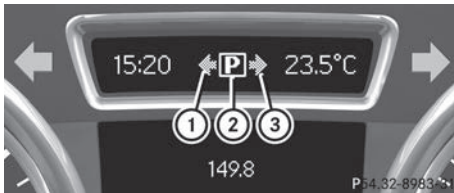

Example: detected parking space for a vehicle with automatic transmission

- ① Detected parking space on the left
- ② Parking symbol
- ③ Detected parking space on the right

Active Parking Assist will only detect parking spaces:

- that are parallel to the direction of travel
- that are at least 59 in (1.5 m) wide
- that are at least 39 in (1.0 m) longer than your vehicle



A parking space is displayed while you are driving past it, and until you are approximately 50 ft (15 m) away from it.

Parking

WARNING

Active Parking Assist merely aids you by intervening actively in the steering. If you do not brake there is a risk of an accident.

Always apply the brakes yourself when maneuvering and parking.

- ▶ Stop the vehicle when the parking space symbol shows the desired parking space in the instrument cluster.
- ▶ Shift the transmission to position **R**. The **Start Park Assist? Yes: OK No: ** message appears in the multifunction display.
- ▶ **To cancel the procedure:** press the **** button on the multifunction steering wheel or pull away.

or

- ▶ **To park using Active Parking Assist:** press the **OK** button on the multifunction steering wheel. The **Park Assist Active Accelerate and Brake Observe Surroundings** message appears in the multifunction display.
- ▶ Let go of the multifunction steering wheel.
- ▶ Back up the vehicle, being ready to brake at all times. Do not exceed a maximum speed of approximately 5 mph (10 km/h) when backing up. Otherwise, Active Parking Assist will be deactivated.
- ▶ **i** In tight parking spaces, you will achieve the best parking results by backing up as far as possible. When doing so, also observe the PARKTRONIC messages.
- ▶ Stop as soon as PARKTRONIC sounds the continuous warning tone, if not before. Maneuvering may be required in tight parking spaces.

The **Park Assist Active Select D Observe Surroundings** message appears in the multifunction display.

- ▶ Shift the transmission to position **D** while the vehicle is stationary. Active Parking Assist immediately steers in the other direction.

The **Park Assist Active Accelerate and Brake Observe Surroundings**

message appears in the multifunction display.

- i** You will achieve the best results by waiting for the steering procedure to complete before pulling away.
- ▶ Drive forwards and be ready to brake at all times.
- ▶ Stop as soon as PARKTRONIC sounds the continuous warning tone, if not before.

The **Park Assist Active Select R Observe Surroundings** message appears in the multifunction display.

- ▶ Further transmission shifts may be necessary.
As soon as the parking procedure is complete, the **Park Assist Finished** message appears in the multifunction display. Active Parking Assist is now deactivated. PARKTRONIC is still available.
- ▶ Maneuver if necessary.
- ▶ Always observe the warning messages displayed by PARKTRONIC (▷ page 162).

Exiting a parking space

WARNING

Active Parking Assist does not monitor street traffic. In some cases, the vehicle will also take you onto sections of the oncoming lane when exiting a parking space.

You are responsible for safety at all times and must pay attention to any road users approaching or passing. Stop the vehicle if necessary or cancel Active Parking Assist.

Active Parking Assist can only assist you with exiting a parking space if you have parked the vehicle using Active Parking Assist.

- ▶ Start the engine.
- ▶ Switch on the turn signal on the side facing the street.
- ▶ Shift the transmission to position **D** or **R**. The **Start Park Assist? Yes: OK No: ** message appears in the multifunction display.

- ▶ **To cancel the procedure:** press the  button on the multifunction steering wheel or pull away.

or

- ▶ **To exit a parking space using Active Parking Assist:** press the  button on the multifunction steering wheel. The **Park Assist Active Accelerate and Brake Observe Surroundings** message appears in the multifunction display.

- ▶ Let go of the multifunction steering wheel.
- ▶ Reverse the vehicle or drive forwards, being ready to brake at all times. Do not exceed a maximum speed of approximately 6 mph (10 km/h) when exiting a parking space. Otherwise, Active Parking Assist will be deactivated.
- ▶ Stop as soon as PARKTRONIC sounds the continuous warning tone, if not before.
- ▶ Shift the transmission to position **D** or **R** as required while the vehicle is stationary. Active Parking Assist immediately steers in the other direction.

- i** You will achieve the best results by waiting for the steering procedure to complete before pulling away.
If you back up after activation, the steering wheel is moved to the straight-ahead position.

- ▶ Drive forwards or back up the vehicle, being ready to brake at all times.
- ▶ Stop as soon as PARKTRONIC sounds the continuous warning tone, if not before.
- ▶ Drive forwards and back up as instructed by the PARKTRONIC warning displays.

Once you have exited the parking space completely, the steering wheel is moved to the straight-ahead position. You hear a tone and the message **Park Assist Finished** appears in the multifunction display. You will then have to steer and merge into traffic on your own. PARKTRONIC is still available.

Canceling Active Parking Assist

You can cancel Active Parking Assist at any time.

- ▶ Stop the movement of the multifunction steering wheel or steer yourself. Active Parking Assist will be canceled at once. The **Park Assist Canceled** message appears in the multifunction display.

or

- ▶ Press the PARKTRONIC button on the center console (▷ page 163). PARKTRONIC is switched off and Active Parking Assist is immediately canceled. The **Park Assist Canceled** message appears in the multifunction display.

Active Parking Assist is canceled automatically if:

- the transmission is shifted too early.
- parking using Active Parking Assist is no longer possible.
- you are driving faster than 6 mph (10 km/h).
- a wheel spins, ESP® intervenes or fails. The  warning lamp lights up in the instrument cluster.

A warning tone sounds. The parking symbol disappears and the multifunction display shows the **Park Assist Canceled** message.

When Active Parking Assist is canceled, you must steer again yourself.

Rear view camera

Important safety notes

The rear view camera is only an aid. It is not a replacement for your attention to your immediate surroundings. You are always responsible for safe maneuvering and parking. When maneuvering or parking, make sure that there are no persons, animals or

objects in the area in which you are maneuvering.

Under the following circumstances, the rear view camera will not function, or will function in a limited manner:

- the tailgate is open
- in heavy rain, snow or fog
- at night or in very dark places
- if the camera is exposed to very bright light
- if the area is lit by fluorescent light or LED lighting (the display may flicker)
- if there is a sudden change in temperature, e.g. when driving into a heated garage in winter
- if the camera lens is dirty or obstructed
- if the rear of your vehicle is damaged. In this event, have the camera position and setting checked at a qualified specialist workshop.

General notes

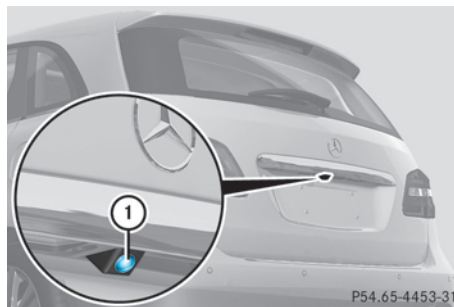

Rear view camera ① is in the trunk lid handle.

Rear view camera ① is an optical parking and maneuvering aid. It uses guide lines to show the area behind your vehicle in the Audio/COMAND display.

The area behind the vehicle is displayed as a mirror image, as in the rear view mirror.

- ❗ The text of messages shown in the COMAND display depends on the language setting. The following are examples of rear view camera messages in the COMAND display.

Activating/deactivating the rear view camera

- ▶ **To activate:** make sure that the SmartKey is in position **2** in the ignition lock.
- ▶ Make sure that in the audio system/COMAND, the "Activation by R gear" function is selected; see the separate operating instructions for the audio system/COMAND.
- ▶ Engage reverse gear.
Guide lines are used to show the area behind the vehicle in the Audio/COMAND display.

To deactivate: the rear view camera is deactivated if you:

- select transmission position **P** (vehicles with automatic transmission)
- drive forward ten meters
- shift the transmission from **R** to another position (after 15 seconds)
- drive forwards at a speed of over 5 mph (10km/h)

Displays in the Audio/COMAND display

The rear view camera may show a distorted view of obstacles, show them incorrectly or not at all. The rear view camera does not show objects in the following positions:

- very close to the rear bumper
- under the rear bumper
- in the area immediately above the tailgate handle

! Objects not at ground level may appear to be further away than they actually are, e.g.:

- the bumper of a parked vehicle
- the drawbar of a trailer
- the ball coupling of a trailer tow hitch
- the rear section of an HGV
- a slanted post

Use the guidelines only for orientation. Approach objects no further than the bottom-most guideline.

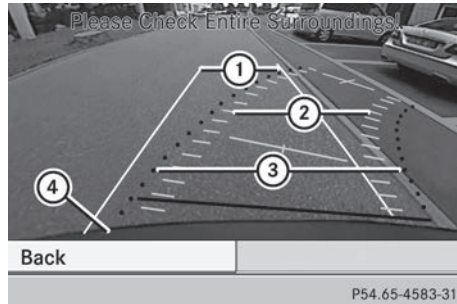

Lanes

- ① White guide line without turning the steering wheel, vehicle width including the exterior mirrors (static)
- ② Yellow lane marking tires at current steering wheel angle, vehicle width to the outer side of the wheels (dynamic)
- ③ Red guide line for the vehicle width including the exterior mirrors, for current steering wheel angle (dynamic)
- ④ Bumper

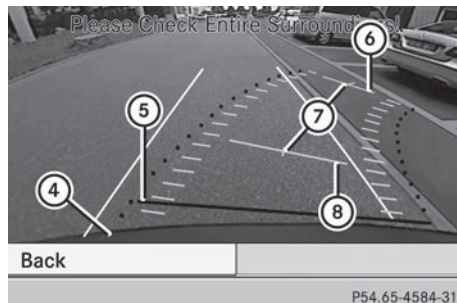

Guide lines

- ④ Bumper
- ⑤ Red guide line at a distance of approximately 12 in (0.30 m) from the rear of the vehicle
- ⑥ Yellow guide line approximately 13 ft (4 m) away from the rear of the vehicle
- ⑦ Vehicle center axle (marker assistance)
- ⑧ Yellow guide line approximately 3 ft (1 m) away from the rear of the vehicle

The lanes and guide lines are only displayed if you have engaged reverse gear.

The distance specifications only apply to objects that are at ground level.



Additional displays on vehicles with PARKTRONIC and COMAND

- ① Front warning display
- ② Additional PARKTRONIC measurement operational readiness indicator
- ③ Rear warning display

Vehicles with PARKTRONIC and COMAND: when PARKTRONIC is operational (> page 161), the additional operational readiness indicator ② appears in the COMAND display. If the PARKTRONIC warning displays are active or light up, then the ① and ③ warning displays are also active or light up correspondingly in the COMAND display.

"Reverse parking" function

- ▶ Make sure that the rear view camera is activated and the "Reverse parking" function is selected; see the separate operating instructions for the audio system/COMAND.
The lane and the guide lines are shown.

Backing up straight into a parking space without turning the steering wheel



- ① White lane with steering wheel straight
- ② Yellow guide line approximately 3 ft (1 m) away from the rear of the vehicle
- ③ Red guide line at a distance of approximately 12 in (0.30 m) from the rear of the vehicle

- ▶ With the help of white lane ①, check whether the vehicle will fit into the parking space.
- ▶ Using the white lane as a guide, carefully back up until you reach the end position. Red guide line ③ is then at the end of the parking space. The vehicle is almost parallel in the parking space.

Reverse perpendicular parking with the steering wheel at an angle

- ▶ Drive past the parking space and bring the vehicle to a standstill.

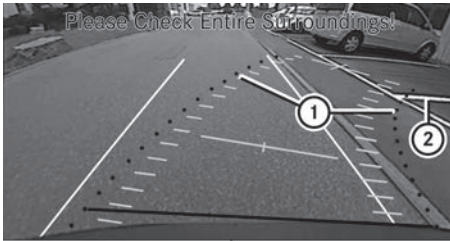

Back

P54.65-4542-31

Turning the steering wheel

- ① Red lane indicating the route the vehicle will take with the steering wheel in its current position
 - ② Parking space marking
- ▶ While the vehicle is at a standstill, turn the steering wheel in the direction of the parking space until the red lane reaches parking space marking ②.
 - ▶ Keep the steering wheel in that position and back up carefully.

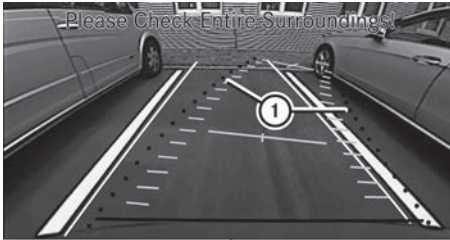

Back

P54.65-4543-31

Backing up with the steering wheel turned

- ① Red lane indicating the route the vehicle will take with the steering wheel in its current position
- ▶ Stop the vehicle when it is almost exactly in front of the parking space. The white lane should be as close to parallel with the parking space marking as possible.

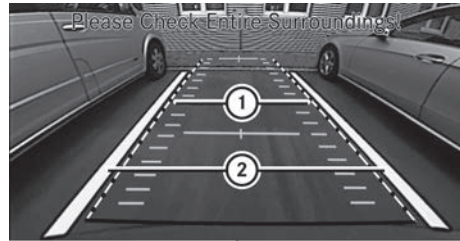

Back

P54.65-4544-31

Driving to the final position

- ① White lane at current steering wheel angle
 - ② Parking space marking
- ▶ Turn the steering wheel to the center position while the vehicle is stationary.



Back

P54.65-4545-31

- ① Red guide line at a distance of approximately 12 in (0.30 m) from the rear of the vehicle
- ② White lane with steering wheel straight
- ③ End of parking space

- ▶ Back up carefully until you have reached the end position. Red guide line ① is then at the end of parking space ③. The vehicle is almost parallel in the parking space.

ATTENTION ASSIST

Introduction

ATTENTION ASSIST helps you during long, monotonous journeys such as on freeways and interstate highways. It is active in the

range between 50 mph (80 km/h) and 112 mph (180 km/h).

If ATTENTION ASSIST detects typical indicators of fatigue or increasing lapses in concentration on the part of the driver, it suggests you take a break.

Important safety notes

ATTENTION ASSIST is only an aid to the driver. It might not always recognize fatigue or increasing inattentiveness in time or fail to recognize them at all. The system is not a substitute for a well-rested and attentive driver.

ATTENTION ASSIST assesses your level of fatigue or lapses in concentration by taking the following criteria into account:

- your personal driving style, e.g. steering characteristics
- driving conditions, e.g. time, driving time

The functionality of ATTENTION ASSIST is restricted and warnings may be delayed or not occur at all:

- if the road condition is poor, e.g. if the surface is uneven or if there are potholes
- if there is a strong side wind
- if you have adopted a sporty driving style with high cornering speeds or high rates of acceleration
- if you are predominantly driving slower than 50 mph (80 km/h) or faster than 112 mph (180 km/h)
- if you are currently using COMAND or making a telephone call with it
- if the time has been set incorrectly
- in active driving situations, such as when you change lanes or change your speed

Warning and display messages in the multifunction display

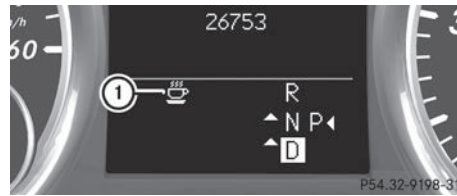

- ▶ Activate ATTENTION ASSIST using the on-board computer (▷ page 188). Symbol ① appears in the multifunction display.

If ATTENTION ASSIST is active, it will not warn you until at least 20 minutes after your journey has begun. You then hear an intermittent warning tone twice and the **Attention Assist: Drowsiness Detected** message appears in the multifunction display.

- ▶ If necessary, take a break.
- ▶ Press the button to confirm the message.

On long journeys, take regular breaks in good time to allow yourself to rest properly. If you do not take a break, you will be warned again after 15 minutes at the earliest. The precondition for this is that ATTENTION ASSIST still detects typical indicators of fatigue or increasing lapses in concentration.

ATTENTION ASSIST is reset when you continue your journey and starts assessing your tiredness again if:

- you switch off the engine.
- you take off your seat belt and open the driver's door, e.g. for a change of drivers or to take a break.

Lane Tracking package

General notes

The Lane Tracking package consists of Blind Spot Assist (▷ page 173) and Lane Keeping Assist (▷ page 174).

Blind Spot Assist

Important safety notes

WARNING

Blind Spot Assist does not react to:

- vehicles overtaken too closely on the side, placing them in the blind spot area
- vehicles approaching and driving by with a speed difference of more than 6.8 mph (11 km/h)

As a result, Blind Spot Assist may not give warnings in such situations. There is a risk of an accident.

Always observe the traffic conditions carefully, and maintain a safe lateral distance.

Blind Spot Assist is merely an aid. It may fail to detect some vehicles and is no substitute for attentive driving.

USA only:

This device has been approved by the FCC as a “Vehicular Radar System”. The radar sensor is intended for use in an automotive radar system only. Removal, tampering, or altering of the device will void any warranties, and is not permitted by the FCC. Do not tamper with, alter, or use in any non-approved way.

Any unauthorized modification to this device could void the user’s authority to operate the equipment.

General notes

Blind Spot Assist uses a radar sensor system to monitor the areas on both sides of your vehicle. It supports you from a speed of approximately 20 mph (30 km/h). A warning display in the exterior mirrors draws your attention to vehicles detected in the

monitored area. If you then switch on the corresponding turn signal to change lane, you will also receive an optical and audible collision warning. For this purpose, Blind Spot Assist uses sensors in the rear bumper.

For Blind Spot Assist to assist you when driving, the radar sensor system must be activated (▷ page 192) and operational.

Monitoring range of the sensors

In particular, the detection of obstacles can be impaired if:

- there is dirt on the sensors or anything else covering the sensors.
- there is poor visibility, e.g. due to fog, heavy rain or snow.
- a narrow vehicle traveling in front, e.g. a motorbike or bicycle.
- the road has very wide lanes.
- the road has narrow lanes.
- you are not driving in the middle of the lane.
- there are barriers or similar lane borders.

Vehicles in the monitoring range are then not indicated.

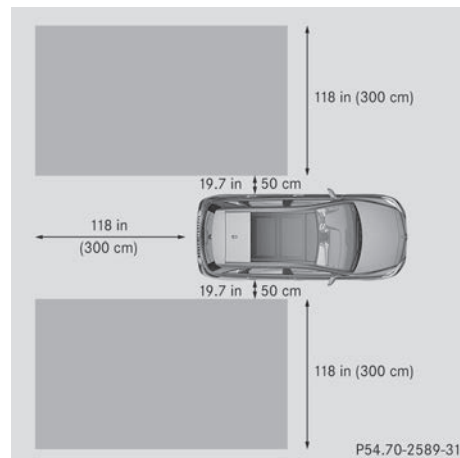

Blind Spot Assist monitors the area up to 10 ft (3.0m) behind your vehicle and directly next to your vehicle, as shown in the diagram. For this purpose, Blind Spot Assist uses radar sensors in the rear bumper.

If the lanes are narrow, vehicles driving in the lane beyond the lane next to your vehicle may be indicated, especially if the vehicles are not driving in the middle of their lane. This may be the case if the vehicles are driving on the inner side of their lane.

Due to the nature of the system:

- warnings may be issued in error when driving close to crash barriers or similar solid lane borders.
- warnings may be interrupted when driving alongside particularly long vehicles, for example trucks, for a prolonged time.

The two sensors for Blind Spot Assist are integrated into the sides of the rear bumper. Make sure that the bumper is free from dirt, ice or slush around the sensors. The rear sensors must not be covered, for example by bicycle racks or overhanging loads. Following a severe impact or in the event of damage to the bumpers, have the function of the radar sensors checked at a qualified specialist workshop. Blind Spot Assist may otherwise not work properly.

Indicator and warning display

Blind Spot Assist is not active at speeds below approximately 20 mph (30 km/h). Vehicles in the monitoring range are then not indicated.

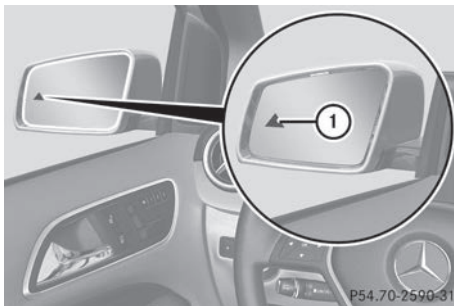

① Yellow indicator lamp/red warning lamp

When Blind Spot Assist is activated, indicator lamp ① in the exterior mirrors lights up yellow at speeds of up to 20 mph (30 km/h). At speeds above 20 mph (30 km/h) the

indicator lamp goes out and Blind Spot Assist is operational.

If a vehicle is detected within the monitoring range of Blind Spot Assist at speeds above 20 mph (30 km/h), warning lamp ① on the corresponding side lights up red. This warning is always emitted when a vehicle enters the blind spot monitoring range from behind or from the side. When you overtake a vehicle, the warning only occurs if the difference in speed is less than 7 mph (12km/h).

The yellow indicator lamp goes out if reverse gear is engaged. In this event, Blind Spot Assist is no longer active.

The brightness of the indicator/warning lamps is adjusted automatically according to the ambient light.

Collision warning

If a vehicle is detected in the monitoring range of Blind Spot Assist and you switch on the corresponding turn signal, a double warning tone sounds. Red warning lamp ① flashes. If the turn signal remains on, detected vehicles are indicated by the flashing of red warning lamp ①. There are no further warning tones.

Switching on Blind Spot Assist

- ▶ Make sure that the radar sensor system (▷ page 192) and Blind Spot Assist (▷ page 188) are activated in the on-board computer.
- ▶ Turn the SmartKey to position **2** in the ignition lock. Warning lamps ① in the exterior mirrors light up red for approximately 1.5 seconds and then turn yellow.

Lane Keeping Assist

General notes

Lane Keeping Assist monitors the area in front of your vehicle by means of a camera at the top of the windshield. Lane Keeping Assist detects lane markings on the road and warns you before you leave your lane unintentionally.

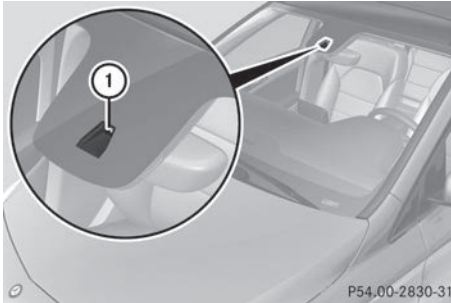

① Lane Keeping Assist camera

If you select **km** on the on-board computer in the **Display Unit Speed-/Odometer:** function (▷ page 189), Lane Keeping Assist is active starting at a speed of 60 km/h. If the **miles** display unit is selected, the assistance range begins at 40 mph.

Important safety notes

WARNING

Lane Keeping Assist may not always clearly recognize lane markings.

In this case, Lane Keeping Assist may:

- give an unnecessary warning
- not give a warning

There is a risk of an accident.

Always pay particular attention to the traffic situation and stay in lane, in particular if warned by Lane Keeping Assist.

WARNING

The Lane Keeping Assist warning does not return the vehicle to the original lane. There is a risk of an accident.

You should always steer, brake or accelerate yourself, in particular if warned by Lane Keeping Assist.

If you fail to adapt your driving style, Lane Keeping Assist can neither reduce the risk of an accident nor override the laws of physics. Lane Keeping Assist cannot take into account the road, traffic and weather conditions. Lane Keeping Assist is merely an aid. You are responsible for the distance to the vehicle in

front, for vehicle speed, for braking in good time and for staying in lane.

Lane Keeping Assist does not keep your vehicle in its lane.

The system may be impaired or may not function if:

- there is poor visibility, e.g. due to insufficient illumination of the road, or due to snow, rain, fog or spray
- there is glare, e.g. from oncoming traffic, the sun or reflections (e.g. when the road surface is wet)
- the windshield is dirty, fogged up, damaged or covered, for instance by a sticker, in the vicinity of the camera
- there are no, several or unclear lane markings for a lane, e.g. in areas with road construction work
- the lane markings are worn away, dark or covered up, e.g. by dirt or snow
- the distance to the vehicle in front is too small and the lane markings thus cannot be detected
- the lane markings change quickly, e.g. lanes branch off, cross one another or merge
- the road is narrow and winding
- there are strong shadows cast on the lane

A warning may be given if a front wheel passes over a lane marking. It will warn you by means of intermittent vibration in the steering wheel for up to 1.5 seconds.

Switching on Lane Keeping Assist

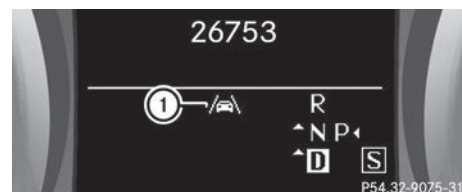

- ▶ Switch on Active Lane Keeping Assist using the on-board computer; to do so, select **Standard** or **Adaptive** (▷ page 188). Symbol ① appears in the multifunction display.

If your speed exceeds 40 mph (60 km/h) and lane markings are detected, symbol ① is highlighted. Lane Keeping Assist is ready for use.

When **Standard** is selected, no warning vibration occurs if:

- you switch on the turn signals. In this event, the warnings are suppressed for a certain period of time.
- a driving safety system intervenes, such as ABS, BAS or ESP®.

When **Adaptive** is selected, no warning vibration occurs if:

- you switch on the turn signals. In this event, the warnings are suppressed for a certain period of time.
- a driving safety system intervenes, e.g. ABS, BAS or ESP®.
- you accelerate hard, e.g. kickdown.
- you brake hard.
- you steer actively, e.g. swerve to avoid an obstacle or change lane quickly.
- you cut the corner on a sharp bend.

In order that you are warned only when necessary and in good time if you cross the lane marking, the system recognizes certain conditions and warns you accordingly.

The warning vibration occurs earlier if:

- you approach the outer lane marking on a bend.
- the road has very wide lanes, e.g. a freeway.
- the system recognizes solid lane markings.

The warning vibration occurs later if:

- the road has narrow lanes.
- you cut the corner on a bend.

Useful information	178
Important safety notes	178
Displays and operation	178
Menus and submenus	182
Display messages	193
Warning and indicator lamps in the instrument cluster	218

Useful information

- i** This Operator's Manual describes all models and all standard and optional equipment of your vehicle available at the time of publication of the Operator's Manual. Country-specific differences are possible. Please note that your vehicle may not be equipped with all features described. This also applies to safety-related systems and functions.
- i** Please read the information on qualified specialist workshops (▷ page 23).

Important safety notes

WARNING

The driver's concentration must always be directed primarily at road traffic.

For your safety and the safety of others, selecting features through the multifunction steering wheel should only be done by the driver when traffic and road conditions permit it to be done safely.

Bear in mind that at a speed of only 30 mph (approximately 50 km/h), the vehicle covers a distance of 44 feet (approximately 14 m) per second.

WARNING

No messages will be displayed if either the instrument cluster or the multifunction display is inoperative.

As a result, you will not be able to see information about your driving conditions, such as

- speed
- outside temperature
- warning/indicator lamps
- malfunction/warning messages
- failure of any systems

Driving characteristics may be impaired.

If you must continue to drive, do so with added caution. Contact an authorized Mercedes-Benz Center as soon as possible.

WARNING

Malfunction and warning messages are only indicated for certain systems and are intentionally not very detailed. The malfunction and warning messages are simply a reminder with respect to the operation of certain systems. They do not replace the owner's and/or driver's responsibility to maintain the vehicle's operating safety. Have all required maintenance and safety checks performed on the vehicle. Bring the vehicle to an authorized Mercedes-Benz Center to address the malfunction and warning messages.

WARNING

All categories of messages contain important information which should be taken note of and, where a malfunction is indicated, addressed as soon as possible at an authorized Mercedes-Benz Center.

Failure to repair the condition noted may cause damage not covered by the Mercedes-Benz Limited Warranty, or result in property damage or personal injury.



You will find an illustration of the instrument cluster in the "At a glance" section (▷ page 27).

Displays and operation

Instrument lighting

The lighting in the instrument cluster, in the displays and the controls in the vehicle interior can be adjusted using the brightness control knob.

The brightness control knob is located on the bottom left of the instrument cluster (▷ page 27).

- ▶ Turn the brightness control knob clockwise or counter-clockwise.
If the light switch is set to **AUTO**,  or , the brightness is dependent upon the brightness of the ambient light.

i The light sensor in the instrument cluster automatically controls the brightness of the multifunction display.

In daylight, the displays in the instrument cluster are not illuminated.

Coolant temperature display

WARNING

Driving when your engine is overheated can cause some fluids which may have leaked into the engine compartment to catch fire. You could be seriously burned.

Steam from an overheated engine can cause serious burns which can occur just by opening the engine hood. Stay away from the engine if you see or hear steam coming from it.

Stop the vehicle in a safe location away from other traffic. Turn off the engine, get out of the vehicle and do not stand near the vehicle until the engine has cooled down.

! A display message is shown if the coolant temperature is too high.

If the coolant temperature is over 248 °F (120 °C), do not continue driving. The engine will otherwise be damaged.

The coolant temperature gage is in the instrument cluster on the right-hand side.

Under normal operating conditions and with the specified coolant level, the coolant temperature may rise to 248 °F (120 °C).

Tachometer

! Do not drive in the overrevving range, as this could damage the engine.

The red band in the tachometer indicates the engine's overrevving range.

The fuel supply is interrupted to protect the engine when the red band is reached.

Outside temperature display

WARNING

The outside temperature indicator is not designed to serve as an ice-warning device and is therefore unsuitable for that purpose. Indicated temperatures just above the freezing point do not guarantee that the road surface is free of ice. The road may still be icy, especially in wooded areas or on bridges.

The outside temperature display is in the multifunction display.

Changes in the outside temperature are displayed after a short delay.

Speedometer with segments

The segments in the speedometer indicate which speed range is available.

- Cruise control activated (▷ page 150):
The segments light up from the stored speed to the maximum speed.
- DISTRONIC PLUS activated (▷ page 152):
One or two segments in the set speed range light up.
- DISTRONIC PLUS detects a vehicle in front:
The segments between the speed of the vehicle in front and the stored speed light up.

Operating the on-board computer

Overview

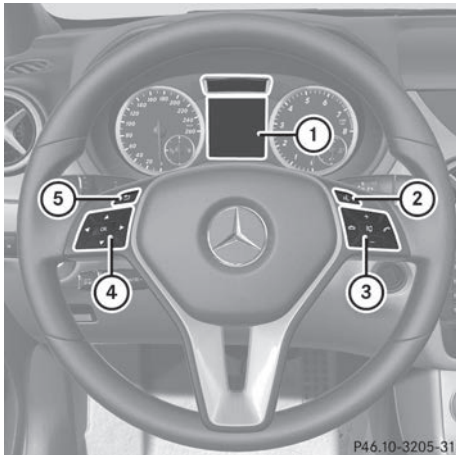

- ① Multifunction display
- ② To switch on the Voice Control System; see the separate operating instructions
- ③ Right control panel
- ④ Left control panel
- ⑤ Back button

► **To activate the on-board computer:** turn the SmartKey to position **1** in the ignition lock.



You can control the multifunction display and the settings in the on-board computer using the buttons on the multifunction steering wheel.

Left control panel



	• Calls up the menu and menu bar
	Press briefly:
	<ul style="list-style-type: none"> • Scrolls in lists • Selects a submenu or function • In the Audio menu: selects a stored station, an audio track or a video scene • In the Tel (telephone) menu: switches to the phone book and selects a name or telephone number
	Press and hold:
	<ul style="list-style-type: none"> • In the Audio menu: selects the previous/next station or selects an audio track or a video scene using rapid scrolling • In the Tel (telephone) menu: starts rapid scrolling through the phone book
	<ul style="list-style-type: none"> • Confirms a selection/display message • In the Tel (Telephone) menu: switches to the telephone book and starts dialing the selected number • In the Audio menu: stops the station search function at the desired station

Right control panel

	<ul style="list-style-type: none"> • Rejects or ends a call • Exits phone book/redial memory
	<ul style="list-style-type: none"> • Makes or accepts a call • Switches to the redial memory

-  • Adjusts the volume
-  • Adjusts the volume
-  • Mute

Back button



-  **Press briefly:**
 - Back
 - Switches off the Voice Control System; see the separate operating instructions
 - Hides display messages/calls up the last **Trip** menu function used
 - Exits the telephone book/redial memory
-  **Press and hold:**
 - Calls up the standard display in the **Trip** menu

Multifunction display



- ① Time
- ② Permanent display: outside temperature or speed (▷ page 190)
- ③ Description field
- ④ Menu bar









- ⑤ Drive program (▷ page 133)
- ⑥ Transmission position (▷ page 133)

► **To show menu bar ④:** press the  or  button on the steering wheel.

Menu bar ④ disappears after a few seconds. Text field ③ shows the selected menu or submenu as well as display messages.

i You can set the time using the audio system or COMAND; see the separate operating instructions.

The following messages may appear in the multifunction display:

-  Active Parking Assist (▷ page 164)
- CRUISE**  Cruise control (▷ page 150)
-  Rear window wiper (▷ page 110)
-  Adaptive Highbeam Assist (▷ page 100)
-  ATTENTION ASSIST (▷ page 171)
-  Lane Keeping Assist (▷ page 174)
-  HOLD function (▷ page 160)
-  Distance warning function (▷ page 228)

Menus and submenus

Menu overview

Operating the on-board computer (▷ page 180).

Depending on the equipment installed in the vehicle, you can call up the following menus:

- **Trip** menu (▷ page 182)
- **Navi** menu (navigation instructions) (▷ page 184)
- **Audio** menu (▷ page 185)
- **Tel** menu (telephone) (▷ page 186)
- **DriveAssist** menu (assistance) (▷ page 187)
- **Serv.** menu (▷ page 189)
- **Sett.** menu (▷ page 189)

The **Audio**, **Navi** and **Tel** menus differ slightly in vehicles with Audio 20 and in vehicles with COMAND. The examples given in this Operator's Manual apply to vehicles equipped with COMAND.

Trip menu

Standard display



- ▶ Press and hold the  button on the steering wheel until the **Trip** menu with trip odometer ① and odometer ② is shown.

Trip computer "From Start" or "From Reset"

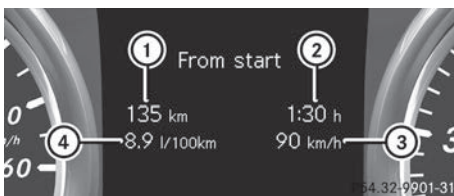





Example: trip computer "From Start"

- ① Distance
- ② Time

- ③ Average speed

- ④ Average fuel consumption

- ▶ Press the  or  button on the steering wheel to select the **Trip** menu.
- ▶ Press the  or  button to select **From Start** or **From Reset**.

The values in the **From Start** submenu are calculated from the start of a journey whilst the values in the **From Reset** submenu are calculated from the last time the submenu was reset (▷ page 183).

The **From Start** trip computer is automatically reset when:

- The ignition has been switched off for more than four hours.
- 999 hours have been exceeded.
- 9,999 miles have been exceeded.

The **From Reset** trip computer is automatically reset if the value exceeds 9,999 hours or 99,999 miles.

ECO display

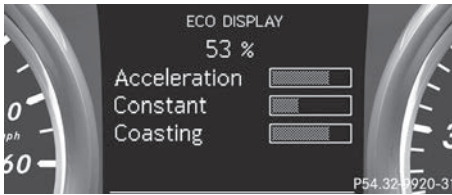

Example: ECO display

- ▶ Press the or button on the steering wheel to select the **Trip** menu.
- ▶ Press the or button to select **ECO DISPLAY**.

If the ignition remains switched off for longer than four hours, the ECO display will be automatically reset.

Further information on the ECO display (▷ page 145).

Displaying the range and current fuel consumption

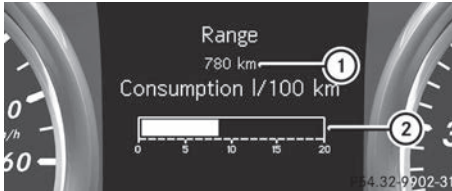

- ① Approximate range
- ② Current fuel consumption

- ▶ Press the or button on the steering wheel to select the **Trip** menu.
- ▶ Press the or button to select current fuel consumption ② and approximate range ①.

Approximate range ① is calculated according to current driving style and the amount of fuel in the tank. If there is only a small amount of fuel left in the fuel tank, the display shows a vehicle being refueled instead of range ①.

Digital speedometer



- ① Digital speedometer

- ▶ Press the or button on the steering wheel to select the **Trip** menu.
- ▶ Press the or button to select digital speedometer ①.

Resetting values

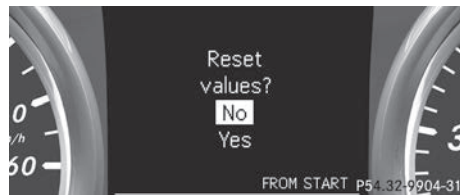

Example: resetting the trip computer "From Start"

You can reset the values of the following functions:

- Trip odometer
- "From Start" trip computer
- "From Reset" trip computer
- ECO display
- ▶ Press the or button on the steering wheel to select the **Trip** menu.
- ▶ Press the or button to select the function that you wish to reset.
- ▶ Press the button.
- ▶ Press the button to select **Yes** and press the button to confirm.

i When you reset the values in the "ECO display", the values in the trip computer "From start" are likewise reset. When you reset the values in the trip computer "From start", the values in the "ECO display" are likewise reset.

Navigation system menu

Displaying navigation instructions

- ▶ Switch on Audio 20 with Becker® MAP PILOT or COMAND (see the separate operating instructions).
- ▶ Press the ◀ or ▶ button on the steering wheel to select the **Navi** menu.

In the **Navi** menu, the multifunction display shows navigation instructions. For more information, see the separate operating instructions.

Route guidance not active

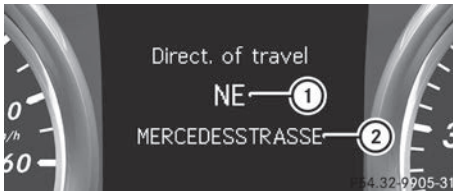

- ① Direction of travel
- ② Current street

Route guidance active

No change of direction announced



- ① Distance to the destination
- ② Distance to the next change of direction
- ③ Current street
- ④ Symbol "follow the road's course"

Change of direction announced without a lane recommendation



- ① Road into which the change of direction leads
- ② Distance to change of direction and visual distance display
- ③ Symbol for change of direction

When a change of direction has been announced, you will see visual distance display ② next to the symbol for change of direction ③. This shortens from the bottom to the top of the display as you approach the point of the announced change of direction.

Change of direction announced with a lane recommendation

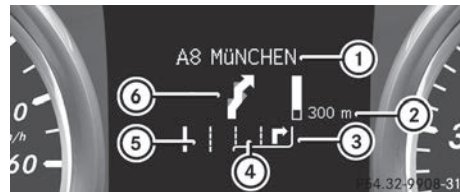

- ① Road into which the change of direction leads
- ② Distance to change of direction and visual distance display
- ③ Lane recommendation
- ④ New lane during a change of direction
- ⑤ Uninterrupted lane
- ⑥ Symbol for change of direction

On multilane roads, the system can display lane recommendation ③ for the next change of direction. During the change of direction, additional lanes may be displayed.

Lane recommendations are only displayed if the relevant data is available on the digital map.

Other status indicators of the navigation system

- : you have reached the destination or an intermediate destination.
- **New Route...** or **Calculating Route:** calculating a new route
- **Off Map** or **Off Mapped Road:** the vehicle position is outside the area of the digital map (off-map position).
- **No Route:** no route could be calculated to the selected destination.







Audio menu

Selecting a radio station





- ① Waveband
- ② Station frequency with memory position

i The memory position is only displayed along with station ② if this has been stored.

- ▶ Switch on the audio system or COMAND and select Radio; see the separate operating instructions.
- ▶ Press the  or  button on the steering wheel to select the **Audio** menu.
- ▶ **To select a stored station:** briefly press the  or  button.
- ▶ **To select a station from the station list:** press and briefly hold the  or  button.

If no station list is received:

- ▶ **To select a station using the station search:** press and briefly hold the  or  button.

i For information on changing waveband and storing stations, see the separate operating instructions.

i SIRIUS XM satellite radio functions like a normal radio.
For more information on satellite radio operation, see the separate operating instructions.







Operating audio player or audio media





CD changer display (example)

- ① Current CD in the CD changer
- ② Current title

Audio data from various audio devices or media can be played, depending on the equipment installed in the vehicle.

- ▶ Switch on the audio system or COMAND and activate audio CD/DVD mode or MP3 mode; see the separate operating instructions.
- ▶ Press the  or  button on the steering wheel to select the **Audio** menu.
- ▶ **To select the next/previous track:** briefly press the  or  button.
- ▶ **To select a track from the track list (rapid scrolling):** press and hold the  or  button until desired track ② has been reached.

If you press and hold  or , the rapid scrolling speed is increased. Not all audio drives or data carriers support this function.

If track information is stored on the audio device or medium, the multifunction display will show the number and title of the track. The current track does not appear in audio

AUX mode (**A**uxiliary audio mode: external audio source connected).

Video DVD operation

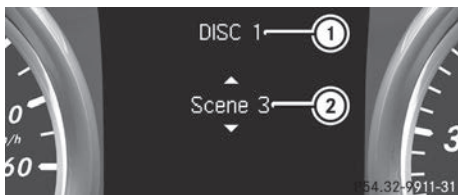

DVD changer display (example)

- ① Current DVD in the DVD changer
- ② Current scene

- ▶ Switch on COMAND and select video DVD; see the separate operating instructions.
- ▶ Press the or button on the steering wheel to select the **Audio** menu.
- ▶ **To select the next/previous scene:** briefly press the or button.
- ▶ **To select a scene from the scene list (rapid scrolling):** press and hold the or button until desired scene ② has been reached.

Telephone menu

Introduction

WARNING

The driver's attention to the road must always be his/her primary focus when driving. For your safety and the safety of others, we recommend that you pull over to a safe location and stop before placing or taking a telephone call. If you choose to use the telephone while driving, please use the hands-free device and only use the telephone when road, weather and traffic conditions permit.

Some jurisdictions prohibit the driver from using a mobile phone while driving a vehicle.

Bear in mind that at a speed of just 30 mph (approximately 50 km/h), your vehicle covers

a distance of 44 feet (approximately 14 m) every second.

- ▶ Switch on your mobile phone and audio system or COMAND, see the separate operating instructions.
- ▶ Establish a Bluetooth® connection to the audio system or COMAND; see the separate operating instructions.
- ▶ Press the or button on the steering wheel to select the **Te1** menu.

You will see one of the following display messages in the multifunction display:

- **Phone READY** or the name of the network provider: the mobile phone has found a network and is ready to receive.
- **Phone No Service:** there is no network available or the mobile phone is searching for a network.

Accepting a call

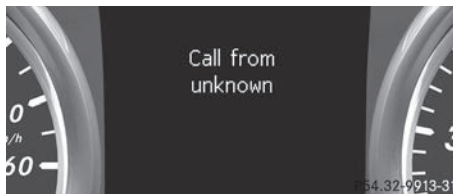

Example: incoming call

- ▶ Press the button on the steering wheel to accept an incoming call.

If someone calls you when you are in the **Te1** menu, a display message appears in the multifunction display.

You can accept a call even if you are not in the **Te1** menu.

Rejecting or ending a call

- ▶ Press the button on the steering wheel.

You can end or reject a call even if you are not in the **Te1** menu.

Dialing a number from the phone book

- ▶ Press the ◀ or ▶ button on the steering wheel to select the **Te1** menu.
- ▶ Press the ▲, ▼ or OK button to switch to the phone book.
- ▶ Press the ▲ or ▼ button to select the desired name.
To start scrolling rapidly, press and hold the ▲ or ▼ button for longer than one second.
Rapid scrolling stops when you release the button or reach the end of the list.
- ▶ **If only one telephone number is stored for a name:** press the ☎ or OK button to start dialing.

or

- ▶ **If there is more than one number for a particular name:** press the ☎ or OK button to display the numbers.
- ▶ Press the ▲ or ▼ button to select the number you want to dial.
- ▶ Press the ☎ or OK button to start dialing.

or

- ▶ **If you do not want to make a call:** press the ☎ or ↩ button.

Redialing

The on-board computer saves the last names or numbers dialed in the redial memory.

- ▶ Press the ◀ or ▶ button on the steering wheel to select the **Te1** menu.
- ▶ Press the ☎ button to switch to the redial memory.
- ▶ Press the ▲ or ▼ button to select the desired name or number.
- ▶ Press the ☎ or OK button to start dialing.

or

- ▶ **If you do not want to make a call:** press the ☎ or ↩ button.

Assistance menu

Introduction

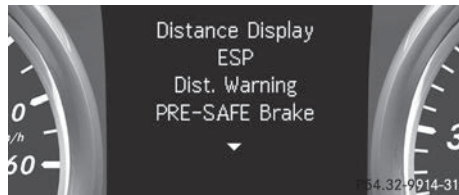

In the **DriveAssist** menu, you have the following options:

- show the distance display
- activate/deactivate ESP®
- activate/deactivate the distance warning function
- activate/deactivate ATTENTION ASSIST
- activate/deactivate Blind Spot Assist
- activate/deactivate Lane Keeping Assist



Showing the distance display

- ▶ Press the ◀ or ▶ button on the steering wheel to select the **DriveAssist** menu.
- ▶ Press the ▲ or ▼ button to select **Distance Display**.
- ▶ Press the OK button.
The DISTRONIC PLUS distance display appears in the multifunction display (▷ page 155).

Deactivating/activating ESP®

Further information about ESP® (▷ page 63).

- ▶ Start the engine.
- ▶ Press the ◀ or ▶ button on the steering wheel to select the **DriveAssist** menu.
- ▶ Press the ▲ or ▼ button to select **ESP**.
- ▶ Press the OK button.

- ▶ **To deactivate:** press again.
The  warning lamp in the instrument cluster lights up.
- ▶ **To activate:** press again.
The  warning lamp in the instrument cluster goes out.

Switching the distance warning function on and off

- ▶ Press the or button on the steering wheel to select the **DriveAssist** menu.
- ▶ Press or to select **Dist. Warning**.
- ▶ Press the button.
The current selection is displayed.
- ▶ **To activate/deactivate:** press the button again.

When the distance warning function is activated, the multifunction display shows the  symbol if the HOLD function is not activated (▷ page 160).

Vehicles with Active Parking Assist: if PARKTRONIC is activated and you are driving at a speed under 22 mph (35 km/h), the Active Parking Assist symbol is shown instead of the  symbol (▷ page 164).

Further information on the distance warning function (▷ page 60).

Activating/deactivating ATTENTION ASSIST

- ▶ Press the or button on the steering wheel to select the **DriveAssist** menu.
- ▶ Press the or button to select **Attention Asst..**
- ▶ Press the button.
The current selection is displayed.
- ▶ **To activate/deactivate:** press the button again.

When ATTENTION ASSIST (▷ page 171) is activated, the  symbol appears in the multifunction display when the ignition is on.

Activating/deactivating Blind Spot Assist

- ▶ Press the or button on the steering wheel to select the **DriveAssist** menu.
- ▶ Press the or button to select **Blind Spot Asst..**
- ▶ Press the button.
The current selection is displayed.
- ▶ **To activate/deactivate:** press the button again.

For further information about Blind Spot Assist, see (▷ page 173).

When the **Blind Spot Assist: Sensors Deactivated** message is shown, the radar sensors are deactivated.

- ▶ Switch on the radar sensor system (▷ page 192).

Activating/deactivating Lane Keeping Assist

- ▶ Press the or button on the steering wheel to select the **DriveAssist** menu.
- ▶ Press the or button to select **Lane Keep. Asst..**
- ▶ Press the button.
The current selection is displayed.
- ▶ Press to confirm.
- ▶ Press the or button to set **Off**, **Standard** or **Adaptive**.
- ▶ Press the button to save the setting.

If Lane Keeping Assist (▷ page 174) is activated and the ignition is switched on, the  symbol appears in the multifunction display.

Service menu



In the **Serv.** menu, you have the following options:

- call up display messages in the message memory (▷ page 193)
- restart the tire pressure loss warning system (▷ page 299)
- call up when a service is due (▷ page 264)

Settings menu

Introduction

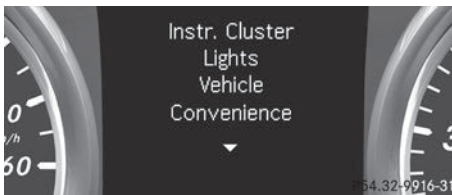

In the **Sett.** menu, you have the following options:

- change the instrument cluster settings
- change the light settings
- change the vehicle settings
- change the convenience settings
- restore the factory settings

Instrument cluster

Selecting the unit of measurement for distance

You can determine whether the multifunction display shows some messages in miles or kilometers.

- ▶ Press the or button on the steering wheel to select the **Sett.** menu.
- ▶ Press the or button to select the **Instr. Cluster** submenu.
- ▶ Press **OK** to confirm.
- ▶ Press the or button to select the **Display Unit Speed-/Odometer:** function.
You will see the selected setting: **km** or **miles**.
- ▶ Press the **OK** button to save the setting.



The selected unit of measurement for distance applies to:

- the digital speedometer in the **Trip** menu
- the odometer and the trip odometer
- the trip computer
- the current consumption and the range
- the navigation instructions in the **Navi** menu
- cruise control
- DISTRONIC PLUS
- ASSYST PLUS service interval display

Switching the additional speedometer on or off

Only vehicles with manual transmission have this function.

- ▶ Press the or button on the steering wheel to select the **Sett.** menu.
- ▶ Press the or button to select the **Instr. Cluster** submenu.
- ▶ Press **OK** to confirm.









- ▶ Press the  or  button to select the **Speedometer [mph]**: function. You will see the selected setting: **On** or **Off**.
- ▶ Press the  button to save the setting.

i Speed is displayed in mph.

The **Speedometer [mph]** function allows you to choose whether the status area in the multifunction display always shows the speed in mph instead of the outside temperature.

Selecting the permanent display function

You can determine whether the multifunction display permanently shows your speed or the outside temperature.





- ▶ Press the  or  button on the steering wheel to select the **Sett.** menu.
- ▶ Press the  or  button to select the **Instr. Cluster** submenu.
- ▶ Press  to confirm.
- ▶ Press the  or  button to select the **Permanent Display**: function. You will see the selected setting **Outside Temperature** or **Speedometer [km/h] (USA)/Speedometer [mph] (Canada)**.
- ▶ Press the  button to save the setting.



i The speed is shown in km/h (USA)/mph (Canada).

Lights

Switching the daytime running lamps on/off









The **Daytime Running Lights**: function can only be set when the engine is switched off.

- ▶ Press the  or  button on the steering wheel to select the **Sett.** menu.
- ▶ Press the  or  button to select the **Lights** submenu.
- ▶ Press  to confirm.

- ▶ Press the  or  button to select the **Daytime Running Lights** function. You will see the selected setting: **Enabled** or **Disabled**.
- ▶ Press the  button to save the setting.

Further information on daytime running lamps (> page 97).

Switching Adaptive Highbeam Assist on/off









- ▶ Press the  or  button on the steering wheel to select the **Sett.** menu.
- ▶ Press the  or  button to select the **Lights** submenu.
- ▶ Press  to confirm.
- ▶ Press the  or  button to select the **Adaptive Highbeam Assist**: function. You will see the selected setting: **Enabled** or **Disabled**.
- ▶ Press the  button to save the setting.

For further information about Adaptive Highbeam Assist, see (> page 100).

Activating/deactivating surround lighting and exterior lighting delayed switch-off

If you have activated the **Locator Lighting**: function and the light switch is set to , the following functions are activated when it is dark:

- **surround lighting**: the exterior lighting remains lit for 40 seconds after unlocking with the SmartKey. If you start the engine, the surround lighting is switched off and automatic headlamp mode is activated (> page 97).
- **exterior lighting delayed switch-off**: the exterior lighting remains lit for 60 seconds after the engine is switched off. If you close all the doors and the tailgate, the exterior lighting goes off after 15 seconds.

- ▶ Press the  or  button on the steering wheel to select the **Sett.** menu.
- ▶ Press the  or  button to select the **Lights** submenu.
- ▶ Press  to confirm.
- ▶ Press the  or  button to select the **Locator Lighting** function.
You will see the selected setting: **Enabled** or **Disabled**.
- ▶ Press the  button to save the setting.

Deactivating delayed switch-off of the exterior lighting temporarily:





- ▶ Before leaving the vehicle, turn the SmartKey to position **0** in the ignition lock.
- ▶ Turn the SmartKey to position **2** in the ignition lock.
The exterior lighting delayed switch-off is deactivated.



Delayed switch-off of the exterior lighting is reactivated the next time you start the engine.

- i** Depending on your vehicle's equipment, when the surround lighting and delayed switch-off exterior lighting are on, the following light up:
 - Parking lamps
 - Front fog lamps
 - Low-beam headlamps
 - Daytime running lamps
 - Side marker lamps
 - Surround lighting in the exterior mirrors

Activating/deactivating the interior lighting delayed switch-off









If you activate the **Interior Lighting Delay**: function, the interior lighting remains on for 20 seconds after you remove the SmartKey from the ignition lock.

- ▶ Press the  or  button on the steering wheel to select the **Sett.** menu.
- ▶ Press the  or  button to select the **Lights** submenu.
- ▶ Press  to confirm.

- ▶ Press the  or  button to select the **Interior Lighting Delay**: function.
You will see the selected setting: **Enabled** or **Disabled**.
- ▶ Press the  button to save the setting.

Vehicle

Activating/deactivating the automatic door locking mechanism









- ▶ Press the  or  button on the steering wheel to select the **Sett.** menu.
- ▶ Press the  or  button to select the **Vehicle** submenu.
- ▶ Press  to confirm.
- ▶ Press the  or  button to select the **Automatic Door Lock**: function.
You will see the selected setting: **Enabled** or **Disabled**.
- ▶ Press the  button to save the setting.

If you select the **Automatic Door Lock**: function, the vehicle is centrally locked above a speed of around 9 mph (15 km/h).







- i** For further information on the automatic locking feature, see (> page 74).

Activating/deactivating the acoustic locking verification signal

If you switch on the **Acoustic Lock Feedback**: function, an acoustic signal sounds when you lock the vehicle.

- ▶ Press the  or  button on the steering wheel to select the **Sett.** menu.
- ▶ Press the  or  button to select the **Vehicle** submenu.
- ▶ Press  to confirm.
- ▶ Press the  or  button to select the **Acoustic Lock Feedback**: function.
You will see the selected setting: **Enabled** or **Disabled**.
- ▶ Press the  button to save the setting.







Activating/deactivating the radar sensor system

- ▶ Press the  or  button on the steering wheel to select the **Settings** menu.
- ▶ Press the  or  button to select the **Vehicle** submenu.
- ▶ Press **OK** to confirm.
- ▶ Press the  or  button to select **Radar Sensor (See Oper. Manual)**:. You will see the selected setting: **Enabled** or **Disabled**.
- ▶ Press the **OK** button to save the setting.

If the radar sensor system is switched off, Blind Spot Assist is deactivated (▷ page 173).

Convenience**Switching the fold-in mirrors when locking feature on/off**

This function is only available on vehicles with the memory function (▷ page 93).







- ▶ Press the  or  button on the steering wheel to select the **Sett.** menu.
- ▶ Press the  or  button to select the **Convenience** submenu.
- ▶ Press **OK** to confirm.
- ▶ Press the  or  button to select the **Fold Mirrors in when Locking**: function. You will see the selected setting: **Enabled** or **Disabled**.
- ▶ Press the **OK** button to save the setting.

If you switch on the **Fold Mirrors in when Locking**: function, the exterior mirrors fold in when you lock the vehicle. If you unlock the vehicle and then open the driver's or front-passenger door, the exterior mirrors fold out again.

If you have switched the function on and you fold the exterior mirrors in using the button on the door (▷ page 91), they will not fold out automatically. The exterior mirrors can then

only be folded out using the button on the door.

Restoring the factory settings

- ▶ Press the  or  button on the steering wheel to select the **Sett.** menu.
- ▶ Press the  or  button to select the **Factory Setting** submenu.
- ▶ Press **OK** to confirm. The **Reset All Settings?** message appears.
- ▶ Press the  or  button to select **No** or **Yes**.
- ▶ Press **OK** to confirm the selection. If you have selected **Yes**, the multifunction display shows a confirmation message.

For safety reasons, the **Daytime Running Lights**: function in the **Lights** submenu is only reset when the vehicle is stationary.

Display messages

General notes

Display messages appear in the multifunction display.

Display messages with graphic displays may be shown in simplified form in the Operator's Manual and may differ from the messages shown in the multifunction display.



Please respond in accordance with the display messages and follow the additional notes in this Operator's Manual.

Certain display messages are accompanied by an audible warning tone or a continuous tone.

When the ignition is switched off, all display messages are deleted, apart from some high-priority display messages. Once the causes of the high-priority display messages have been rectified, the corresponding display messages are also deleted.

When you stop and park the vehicle, please observe the notes on the HOLD function (> page 160) and parking (> page 141).

Hiding display messages







- ▶ Press the  or  button on the steering wheel to hide the display message. The display message is cleared.

The multifunction display shows high-priority display messages in red. Some high-priority display messages cannot be hidden.

The multifunction display shows these messages continuously until the causes for the messages have been remedied.

Message memory

The on-board computer saves certain display messages in the **message memory**. You can call up the display messages:

- ▶ Press the  or  button on the steering wheel to select the **Serv.** menu. If there are display messages, the multifunction display shows **2 Messages**, for example.
- ▶ Press the  or  button to select the entry, e.g. **2 Messages**.
- ▶ Press  to confirm.
- ▶ Press the  or  button to scroll through the display messages.

Safety systems

Display messages





Currently
Unavailable See
Operator's Manual

Possible causes/consequences and ► Solutions

ABS (Anti-lock Braking System), ESP® (Electronic Stability Program), BAS (Brake Assist), PRE-SAFE®, the HOLD function and hill start assist are temporarily unavailable.

COLLISION PREVENTION ASSIST may also have failed.

In addition, the ,  and  warning lamps light up in the instrument cluster.

ATTENTION ASSIST is deactivated.

Possible causes are:

- Self-diagnosis is not yet complete.
- The on-board voltage may be insufficient.

 **WARNING**

The brake system continues to function normally, but without the functions listed above. The wheels could therefore lock if you brake hard, for example.

The steerability and braking characteristics may be severely affected. The braking distance in an emergency braking situation can increase.

If ESP® is not operational, ESP® is unable to stabilize the vehicle. There is an increased risk of skidding and an accident.

► Carefully drive a short distance on a suitable stretch of road, making slight steering movements at a speed above 12 mph (20 km/h).

If the display message disappears, the functions mentioned above are available again.

If the display message continues to be displayed:





- Drive on carefully.
- Visit a qualified specialist workshop.



Inoperative See
Operator's Manual

ABS, ESP®, BAS, PRE-SAFE®, the HOLD function and hill start assist are unavailable due to a malfunction.





COLLISION PREVENTION ASSIST may also have failed.

In addition, the , ,  and  warning lamps light up in the instrument cluster.

ATTENTION ASSIST is deactivated.

 **WARNING**

The brake system continues to function normally, but without the functions listed above. The wheels could therefore lock if you brake hard, for example.



Display messages	Possible causes/consequences and ► Solutions
	<p>The steerability and braking characteristics may be severely affected. The braking distance in an emergency braking situation can increase.</p> <p>If ESP® is not operational, ESP® is unable to stabilize the vehicle. There is an increased risk of skidding and an accident.</p> <ul style="list-style-type: none"> ► Drive on carefully. ► Visit a qualified specialist workshop immediately.
<div style="border: 1px solid black; padding: 2px; width: 40px; height: 40px; margin-bottom: 5px;">  </div> <p>Currently Unavailable See Operator's Manual</p>	<p>ESP®, BAS, PRE-SAFE®, the HOLD function and hill start assist are temporarily unavailable.</p> <p>COLLISION PREVENTION ASSIST may also have failed.</p> <p>In addition, the  and  warning lamps light up in the instrument cluster.</p> <p>ATTENTION ASSIST is deactivated.</p> <p>The self-diagnosis function might not be complete, for example.</p> <p> WARNING</p> <p>The brake system continues to function normally, but without the functions listed above.</p> <p>The braking distance in an emergency braking situation can thus increase.</p> <p>If ESP® is not operational, ESP® is unable to stabilize the vehicle. There is an increased risk of skidding and an accident.</p> <ul style="list-style-type: none"> ► Carefully drive a short distance on a suitable stretch of road, making slight steering movements at a speed above 12 mph (20 km/h). <p>If the display message disappears, the functions mentioned above are available again.</p> <p>If the display message continues to be displayed:</p> <ul style="list-style-type: none"> ► Drive on carefully. ► Visit a qualified specialist workshop.

Display messages**Possible causes/consequences and ► Solutions**

Inoperative See
Operator's Manual

ESP[®], BAS, PRE-SAFE[®], the HOLD function and hill start assist are unavailable due to a malfunction.

COLLISION PREVENTION ASSIST may also have failed.

In addition, the  and  warning lamps light up in the instrument cluster.

ATTENTION ASSIST is deactivated.

 **WARNING**

The brake system continues to function normally, but without the functions listed above.

The braking distance in an emergency braking situation can thus increase.

If ESP[®] is not operational, ESP[®] is unable to stabilize the vehicle.

There is an increased risk of skidding and an accident.

- Drive on carefully.
- Visit a qualified specialist workshop.





Inoperative See
Operator's Manual



EBD (electronic brake force distribution), ABS, ESP[®], BAS, PRE-SAFE[®], the HOLD function and hill start assist are unavailable due to a malfunction.

COLLISION PREVENTION ASSIST may also have failed.

In addition, the ,  and  warning lamps light up in the instrument cluster and a warning tone sounds.

ATTENTION ASSIST is deactivated.

 **WARNING**







The brake system continues to function normally, but without the functions listed above. The front and rear wheels could therefore lock if you brake hard, for example.







The steerability and braking characteristics may be severely affected. The braking distance in an emergency braking situation can increase.







If ESP[®] is not operational, ESP[®] is unable to stabilize the vehicle.





There is an increased risk of skidding and an accident.



- Drive on carefully.
- Visit a qualified specialist workshop immediately.









Display messages	Possible causes/consequences and ► Solutions
 Please Release Parking Brake	<p>The red  indicator lamp flashes and a warning tone sounds. A condition for automatic release of the electric parking brake is not fulfilled (► page 142).</p> <p>You are driving with the electric parking brake applied.</p> <ul style="list-style-type: none"> ► Release the electric parking brake manually. <p>The red  indicator lamp flashes and a warning tone sounds. You are making an emergency stop using the electric parking brake (► page 142).</p>
 Parking Brake See Operator's Manual	<p>The yellow  warning lamp lights up. The electric parking brake is malfunctioning.</p> <p>To apply:</p> <ul style="list-style-type: none"> ► Switch the ignition off. ► Press the electric parking brake handle for at least ten seconds. ► Shift the transmission to P. ► Consult a qualified specialist workshop. <p>The yellow  warning lamp and the red  indicator lamp are lit. The electric parking brake is malfunctioning.</p> <p>To release:</p> <ul style="list-style-type: none"> ► Switch off the ignition and turn it back on. ► Release the electric parking brake manually. <p>or</p> <ul style="list-style-type: none"> ► Release the electric parking brake automatically (► page 142). <p>If the electric parking brake still cannot be released:</p> <ul style="list-style-type: none"> ► Do not drive on. ► Consult a qualified specialist workshop.

Display messages	Possible causes/consequences and ► Solutions
	<p>The red  indicator lamp flashes and the yellow  warning lamp is lit.</p> <p>The electric parking brake is malfunctioning.</p> <p>To release:</p> <ul style="list-style-type: none"> ► Switch off the ignition and turn it back on. ► Release the electric parking brake manually. <p>To apply:</p> <ul style="list-style-type: none"> ► Switch off the ignition and turn it back on. ► Apply the electric parking brake manually. <p>If the red  indicator lamp continues to flash:</p> <ul style="list-style-type: none"> ► Do not drive on. ► Secure the vehicle against rolling away (▷ page 313). ► Shift the transmission to P. ► Turn the front wheels towards the curb. ► Consult a qualified specialist workshop.
	<p>The yellow  warning lamp lights up. The red  indicator lamp flashes for about ten seconds after the electric parking brake has been applied or released. It then goes out or remains lit.</p> <p>The electric parking brake is malfunctioning.</p> <ul style="list-style-type: none"> ► Switch off the ignition and turn it back on. ► Apply the electric parking brake. <p>If it is not possible to engage the electric parking brake:</p> <ul style="list-style-type: none"> ► Shift the transmission to P. ► Visit a qualified specialist workshop. <p>If it is not possible to release the electric parking brake:</p> <ul style="list-style-type: none"> ► Release the electric parking brake automatically (▷ page 142). <p>If the electric parking brake still cannot be released:</p> <ul style="list-style-type: none"> ► Consult a qualified specialist workshop.
	<p>The yellow  warning lamp lights up. If you manually apply or release the electric parking brake, the red  indicator lamp flashes.</p> <p>The electric parking brake is malfunctioning. It is not possible to apply the electric parking brake manually.</p> <ul style="list-style-type: none"> ► Shift the transmission to P as the electric parking brake is not being applied automatically. ► Visit a qualified specialist workshop.

Display messages	Possible causes/consequences and ► Solutions
 <p>Parking Brake Inoperative</p>	<p>The yellow  warning lamp lights up. The red  indicator lamp flashes for about ten seconds after the electric parking brake has been applied or released. It then goes out or remains lit.</p> <p>The electric parking brake is malfunctioning, e.g. because of overvoltage or undervoltage.</p> <ul style="list-style-type: none"> ► Remove the cause for the overvoltage or undervoltage, e.g. by charging the battery or restarting the engine. ► Engage or release the electric parking brake. <p>If it remains impossible to apply or release the electric parking brake:</p> <ul style="list-style-type: none"> ► Switch off the ignition and turn it back on. ► Engage or release the electric parking brake. <p>If the electric parking brake still cannot be released:</p> <ul style="list-style-type: none"> ► Consult a qualified specialist workshop. <hr/> <p>The display message is only shown while the vehicle is in motion. The red  indicator lamp flashes and the yellow  warning lamp is lit.</p> <p>It is not possible to apply the electric parking brake manually.</p> <ul style="list-style-type: none"> ► Shift the transmission to P. ► Visit a qualified specialist workshop.
 <p>Turn On the Ignition to Release the Parking Brake</p>	<p>The red  indicator lamp is lit.</p> <p>You attempted to release the electric parking brake while the ignition was switched off.</p> <ul style="list-style-type: none"> ► Turn the SmartKey to position 1 in the ignition lock.

Display messages	Possible causes/consequences and ► Solutions
 <p>Check Brake Fluid Level</p>	<p>There is not enough brake fluid in the brake fluid reservoir. In addition, the red  warning lamp lights up in the instrument cluster and a warning tone sounds.</p> <p> WARNING</p> <p>The braking effect may be impaired. There is a risk of an accident.</p> <ul style="list-style-type: none"> ► Pull over and stop the vehicle safely as soon as possible, paying attention to road and traffic conditions. Do not continue driving under any circumstances. ► Secure the vehicle against rolling away (▷ page 141). ► Do not add brake fluid. Topping up will not remedy the malfunction. ► Consult a qualified specialist workshop.
 <p>Check Brake Pad Wear</p>	<p>The brake pads/linings have reached their wear limit.</p> <ul style="list-style-type: none"> ► Visit a qualified specialist workshop.
 <p>mbrace Inoperative</p>	<p>One or more main features of the mbrace system are malfunctioning.</p> <ul style="list-style-type: none"> ► Have the mbrace system checked immediately at a qualified specialist workshop.







Display messages	Possible causes/consequences and ► Solutions
<p>PRE-SAFE Functions Currently Limited See Operator's Manual</p>	<p>Adaptive Brake Assist is temporarily inoperative. Possible causes are:</p> <ul style="list-style-type: none"> • the radar sensor system cover in the radiator grill is dirty. • function is impaired due to heavy rain or snow. • the radar sensor system is temporarily inoperative, e.g. due to electromagnetic radiation emitted by nearby TV or radio stations or other sources of electromagnetic radiation. • the system is outside the operating temperature range. • the on-board voltage is too low. <p>When the causes stated above no longer apply, the display message disappears.</p> <p>Adaptive Brake Assist is operational again.</p> <p>If the display message does not disappear:</p> <ul style="list-style-type: none"> ► Pull over and stop the vehicle safely as soon as possible, paying attention to road and traffic conditions. ► Secure the vehicle against rolling away (▷ page 141). ► Clean the radar sensor cover in the radiator grill (▷ page 269). ► Restart the engine.
<p>PRE-SAFE Functions Limited See Operator's Manual</p>	<p>Adaptive Brake Assist is faulty. The distance warning signal may also have failed.</p> <ul style="list-style-type: none"> ► Visit a qualified specialist workshop.
<p> SRS Malfunction Service Required</p>	<p>There is a malfunction in the SRS (Supplemental Restraint System). The  warning lamp also lights up in the instrument cluster.</p> <p>▲ WARNING</p> <p>The air bags or Emergency Tensioning Devices may either be triggered unintentionally or, in the event of an accident, may not be triggered.</p> <p>There is an increased risk of injury.</p> <ul style="list-style-type: none"> ► Visit a qualified specialist workshop. <p>Further information on occupant safety (▷ page 36).</p>







Display messages	Possible causes/consequences and ► Solutions
 <p>Front Left Malfunction Service Required or Front Right Malfunction Service Required</p>	<p>SRS has malfunctioned at the front on the left or right. The  warning lamp also lights up in the instrument cluster.</p> <p>⚠ WARNING</p> <p>The air bags or Emergency Tensioning Devices may either be triggered unintentionally or, in the event of an accident, may not be triggered.</p> <p>There is an increased risk of injury.</p> <p>► Visit a qualified specialist workshop.</p>
 <p>Rear Left Malfunction Service Required or Rear Right Malfunction Service Required</p>	<p>SRS has malfunctioned at the rear on the left or right. The  warning lamp also lights up in the instrument cluster.</p> <p>⚠ WARNING</p> <p>The air bags or Emergency Tensioning Devices may either be triggered unintentionally or, in the event of an accident, may not be triggered.</p> <p>There is an increased risk of injury.</p> <p>► Visit a qualified specialist workshop.</p>
 <p>Rear Center Malfunction Service Required</p>	<p>SRS has malfunctioned at the rear center. The  warning lamp also lights up in the instrument cluster.</p> <p>⚠ WARNING</p> <p>The air bags or Emergency Tensioning Devices may either be triggered unintentionally or, in the event of an accident, may not be triggered.</p> <p>There is an increased risk of injury.</p> <p>► Visit a qualified specialist workshop.</p>
 <p>Left Side Curtain Airbag Malfunction Service Required or Right Side Curtain Airbag Service Required</p>	<p>There is a malfunction in the left-hand or right-hand window curtain air bag. The  warning lamp also lights up in the instrument cluster.</p> <p>⚠ WARNING</p> <p>The left or right window curtain air bag may either be triggered unintentionally or, in the event of an accident, may not be triggered.</p> <p>There is an increased risk of injury.</p> <p>► Visit a qualified specialist workshop.</p>









Lights

- i** Display messages about LEDs:

This display message will only appear if all LEDs have failed.



Display messages	Possible causes/consequences and ► Solutions
 Check Left Cornering Light or Check Right Cornering Light	The left or right-hand cornering light is defective. ► Check whether you are permitted to replace the bulb yourself (▷ page 102). or ► Visit a qualified specialist workshop.
 Check Left Low Beam or Check Right Low Beam	The left or right-hand low-beam headlamp is defective. ► Check whether you are permitted to replace the bulb yourself (▷ page 102). or ► Visit a qualified specialist workshop.
 Check Rear Left Turn Signal or Check Rear Right Turn Signal	The rear left-hand or rear right-hand turn signal is defective. ► Check whether you are permitted to replace the bulb yourself (▷ page 102). or ► Visit a qualified specialist workshop.
 Check Front Left Turn Signal or Check Front Right Turn Signal	The front left-hand or front right-hand turn signal is defective. ► Check whether you are permitted to replace the bulb yourself (▷ page 102). or ► Visit a qualified specialist workshop.
 Check Left Mirror Turn Signal or Check Right Mirror Turn Signal	The turn signal in the left-hand or right-hand exterior mirror is defective. ► Check whether you are permitted to replace the bulb yourself (▷ page 102). or ► Visit a qualified specialist workshop.
 Check Center Brake Lamp	The high-mounted brake lamp is faulty. ► Check whether you are permitted to replace the bulb yourself (▷ page 102). or ► Visit a qualified specialist workshop.



Display messages	Possible causes/consequences and ► Solutions
 <p>Check Left Brake Lamp or Check Right Brake Lamp</p>	<p>The left or right-hand brake lamp is defective.</p> <ul style="list-style-type: none"> ► Check whether you are permitted to replace the bulb yourself (> page 102). <p>or</p> <ul style="list-style-type: none"> ► Visit a qualified specialist workshop.
 <p>Check Left Tail and Brake Lamps or Check Right Tail and Brake Lamps</p>	<p>The left or right-hand tail lamp/brake lamp is defective.</p> <ul style="list-style-type: none"> ► Check whether you are permitted to replace the bulb yourself (> page 102). <p>or</p> <ul style="list-style-type: none"> ► Visit a qualified specialist workshop.
 <p>Check Left High Beam or Check Right High Beam</p>	<p>The left or right-hand high beam is defective.</p> <ul style="list-style-type: none"> ► Check whether you are permitted to replace the bulb yourself (> page 102). <p>or</p> <ul style="list-style-type: none"> ► Visit a qualified specialist workshop.
 <p>License Plate Lamp</p>	<p>The left or right-hand license plate lamp is defective.</p> <ul style="list-style-type: none"> ► Check whether you are permitted to replace the bulb yourself (> page 102). <p>or</p> <ul style="list-style-type: none"> ► Visit a qualified specialist workshop.
 <p>Check Left Fog Lamp or Check Right Fog Lamp</p>	<p>The left-hand or right-hand front fog lamp is defective.</p> <ul style="list-style-type: none"> ► Check whether you are permitted to replace the bulb yourself (> page 102). <p>or</p> <ul style="list-style-type: none"> ► Visit a qualified specialist workshop.
 <p>Rear Fog Lamp</p>	<p>The rear fog lamp is defective.</p> <ul style="list-style-type: none"> ► Check whether you are permitted to replace the bulb yourself (> page 102). <p>or</p> <ul style="list-style-type: none"> ► Visit a qualified specialist workshop.
 <p>Check Front Left Parking Lamp or Check Front Right Parking Lamp</p>	<p>The front left or front right parking or standing lamp is defective.</p> <ul style="list-style-type: none"> ► Check whether you are permitted to replace the bulb yourself (> page 102). <p>or</p> <ul style="list-style-type: none"> ► Visit a qualified specialist workshop.



Display messages	Possible causes/consequences and ► Solutions
 Backup Light	<p>The backup lamp is defective.</p> <ul style="list-style-type: none"> ► Check whether you are permitted to replace the bulb yourself (> page 102). <p>or</p> <ul style="list-style-type: none"> ► Visit a qualified specialist workshop.
 Check Left Tail Lamp or Check Right Tail Lamp	<p>The left or right-hand tail lamp is defective.</p> <ul style="list-style-type: none"> ► Check whether you are permitted to replace the bulb yourself (> page 102). <p>or</p> <ul style="list-style-type: none"> ► Visit a qualified specialist workshop.
 Check Front Left Sidemarker Lamp or Check Front Right Sidemarker Lamp	<p>The left or right front side marker lamp is defective.</p> <ul style="list-style-type: none"> ► Check whether you are permitted to replace the bulb yourself (> page 102). <p>or</p> <ul style="list-style-type: none"> ► Visit a qualified specialist workshop.
 Check Rear Left Sidemarker Lamp or Check Rear Right Sidemarker Lamp	<p>The rear left or right side marker lamp is defective.</p> <ul style="list-style-type: none"> ► Check whether you are permitted to replace the bulb yourself (> page 102). <p>or</p> <ul style="list-style-type: none"> ► Visit a qualified specialist workshop.
 Check Left Daytime Running Light or Check Right Daytime Running Light	<p>The left-hand or right-hand daytime running lamp is faulty.</p> <ul style="list-style-type: none"> ► Check whether you are permitted to replace the bulb yourself (> page 102). <p>or</p> <ul style="list-style-type: none"> ► Visit a qualified specialist workshop.
 Active Headlamps Inoperative	<p>The active light function is defective.</p> <ul style="list-style-type: none"> ► Visit a qualified specialist workshop.
 Malfunction See Operator's Manual	<p>The exterior lighting is defective.</p> <ul style="list-style-type: none"> ► Visit a qualified specialist workshop.
 Auto Lamp Function Inoperative	<p>The light sensor is defective.</p> <ul style="list-style-type: none"> ► Visit a qualified specialist workshop.



Display messages	Possible causes/consequences and ► Solutions
 Switch Off Lights	<p>The lights are still switched on when you leave the vehicle. A warning tone also sounds.</p> <p>► Turn the light switch to AUTO.</p>
Adaptive Highbeam Assist Inoperative	<p>Adaptive Highbeam Assist is faulty.</p> <p>► Visit a qualified specialist workshop.</p>
Adaptive Highbeam Assist Currently Unavailable See Operator's Manual	<p>Adaptive Highbeam Assist is deactivated and temporarily inoperative. Possible causes are:</p> <ul style="list-style-type: none"> • the windshield in the camera's field of vision is dirty. • visibility is impaired due to heavy rain, snow or fog. <p>► Clean the windshield.</p> <p>If the system detects that the camera is fully operational again, the Adaptive Highbeam Assist Now Available message is displayed.</p> <p>Adaptive Highbeam Assist is operational again.</p>



Engine

Display messages	Possible causes/consequences and ► Solutions
 Check Coolant Level See Operator's Manual	<p>The coolant level is too low.</p> <p>! Avoid making long journeys with too little coolant in the engine cooling system. The engine will otherwise be damaged.</p> <p>► Add coolant, observing the warning notes before doing so (► page 263).</p> <p>► If coolant needs to be added more often than usual, have the engine coolant system checked at a qualified specialist workshop.</p>
	<p>The fan motor is faulty.</p> <p>► At coolant temperatures under 248 °F (120 °C), drive to the next qualified specialist workshop.</p> <p>► Avoid subjecting the engine to heavy loads, e.g. driving in mountainous terrain, and stop-and-go traffic.</p>

Display messages	Possible causes/consequences and ► Solutions
 <p data-bbox="211 327 431 413">Coolant Too Hot Stop Vehicle Turn Engine Off</p>	<p data-bbox="471 275 758 336">The coolant is too hot. A warning tone also sounds.</p> <p data-bbox="481 354 632 383"> WARNING</p> <p data-bbox="471 397 1134 480">Do not drive when your engine is overheated. This can cause some fluids which may have leaked into the engine compartment to catch fire.</p> <p data-bbox="471 491 1122 544">Vapor from the overheated engine can also cause serious burns which can occur just by opening the hood.</p> <p data-bbox="471 555 708 580">There is a risk of injury.</p> <ul data-bbox="471 591 1134 1003" style="list-style-type: none"> ▶ Pull over and stop the vehicle safely and switch off the engine, paying attention to road and traffic conditions. ▶ Secure the vehicle against rolling away (► page 141). ▶ Leave the vehicle and keep a safe distance from the vehicle until the engine has cooled down. ▶ Make sure that the air supply to the engine radiator is not blocked, e.g. by snow, slush or ice. ▶ Do not start the engine again until the display message goes out and the coolant temperature is under 248 °F (120 °C). Otherwise, the engine could be damaged. ▶ Pay attention to the coolant temperature display. ▶ If the temperature increases again, visit a qualified specialist workshop immediately. <p data-bbox="471 1017 1134 1071">Under normal operating conditions and with the specified coolant level, the coolant temperature may rise to 248 °F (120 °C).</p>

Display messages	Possible causes/consequences and ► Solutions
	<p>The battery is not being charged. A warning tone also sounds.</p> <p>Possible causes are:</p> <ul style="list-style-type: none"> • a defective alternator • a torn poly-V-belt • a malfunction in the electronics <p>► Pull over and stop the vehicle safely and switch off the engine, paying attention to road and traffic conditions.</p> <p>► Open the hood.</p> <p>► Check whether the poly-V-belt is torn.</p> <p>If the poly-V-belt is torn:</p> <p>! Do not continue driving. The engine could otherwise overheat.</p> <p>► Consult a qualified specialist workshop.</p> <p>If the poly-V-belt is not damaged:</p> <p>► Visit a qualified specialist workshop immediately.</p>
 <p>Check Engine Oil At Next Refueling</p>	<p>The engine oil level has dropped to the minimum level. A warning tone also sounds.</p> <p>► Check the oil level when next refueling, at the latest (> page 261).</p> <p>► If necessary, add engine oil (> page 262).</p> <p>► Have the engine checked at a qualified specialist workshop if engine oil needs to be added more often than usual.</p> <p>! Avoid long journeys with too little engine oil. The engine will otherwise be damaged.</p> <p>Information on approved engine oils can be obtained from any qualified specialist workshop.</p>
 <p>Fuel Level Low</p>	<p>The fuel level has dropped into the reserve range.</p> <p>► Refuel at the nearest gas station.</p>

Display messages	Possible causes/consequences and ► Solutions
	There is only a very small amount of fuel in the fuel tank. ► Refuel at the nearest gas station without fail.
 Gas Cap Loose	The fuel system pressure is too low. The fuel filler cap is not closed correctly or the fuel system is leaking. ► Check that the fuel filler cap is correctly closed. If the fuel filler cap is not correctly closed: ► Close the fuel filler cap. If the fuel filler cap is correctly closed: ► Visit a qualified specialist workshop.

Driving systems	
Display messages	Possible causes/consequences and ► Solutions
 Attention Assist: Take a Break!	Based on certain criteria, ATTENTION ASSIST has detected fatigue or a lack of concentration on the part of the driver. A warning tone also sounds. ► If necessary, take a break. During long journeys, take regular breaks in good time so you get enough rest.
 Attention Assist Inoperative	ATTENTION ASSIST is inoperative. ► Visit a qualified specialist workshop.
 HOLD Off	The HOLD function is deactivated. The vehicle is skidding. A warning tone also sounds. ► Reactivate the HOLD function later (► page 160). The HOLD function is deactivated. When the brake pedal is firmly depressed, an activation condition is not fulfilled. A warning tone also sounds. ► Check the activation conditions for the HOLD function (► page 160).
Radar Sensors Deactivated See Operator's Manual	The radar sensor system is deactivated. ► Switch on the radar sensor system (► page 192).

Display messages	Possible causes/consequences and ► Solutions
<p>Lane Keeping Assist Currently Unavailable See Operator's Manual</p>	<p>Lane Keeping Assist is deactivated and temporarily inoperative. Possible causes are:</p> <ul style="list-style-type: none"> • the windshield in the camera's field of vision is dirty. • visibility is impaired due to heavy rain, snow or fog. • there are no lane markings for a longer period. • the lane markings are worn, dark or covered, e.g. by dirt or snow. <p>When the causes stated above no longer apply, the display message disappears.</p> <p>Lane Keeping Assist is operational again.</p> <p>If the display message does not disappear:</p> <ul style="list-style-type: none"> ► Pull over and stop the vehicle safely as soon as possible, paying attention to road and traffic conditions. ► Secure the vehicle against rolling away (▷ page 141). ► Clean the windshield.
<p>Lane Keeping Assist Inoperative</p>	<p>Lane Keeping Assist is faulty.</p> <ul style="list-style-type: none"> ► Visit a qualified specialist workshop.
<p>Blind Spot Assist Currently Unavailable See Operator's Manual</p>	<p>Blind Spot Assist is temporarily inoperative. Possible causes are:</p> <ul style="list-style-type: none"> • the sensors are dirty. • function is impaired due to heavy rain or snow. • the radar sensor system is outside the operating temperature range. • the radar sensor system is temporarily inoperative, e.g. due to electromagnetic radiation emitted by nearby TV or radio stations or other sources of electromagnetic radiation. <p>The yellow  indicator lamps also light up in the exterior mirrors.</p> <p>When the causes stated above no longer apply, the display message disappears.</p> <p>Blind Spot Assist is operational again.</p> <p>If the display message does not disappear:</p> <ul style="list-style-type: none"> ► Pull over and stop the vehicle safely as soon as possible, paying attention to road and traffic conditions. ► Secure the vehicle against rolling away (▷ page 141). ► Clean the sensors (▷ page 269). ► Restart the engine.

Display messages	Possible causes/consequences and ► Solutions
Blind Spot Assist Inoperative	<p>Blind Spot Assist is defective.</p> <p>The yellow  indicator lamps also light up in the exterior mirrors.</p> <p>► Visit a qualified specialist workshop.</p>
Park Assist Canceled	<p>The driver's door is open and the driver's seat belt has not been fastened.</p> <p>► Repeat the parking process with the seat belt fastened and the driver's door closed.</p> <p>You have inadvertently touched the multifunction steering wheel while steering intervention was active.</p> <p>► While steering intervention is active, make sure that the multifunction steering wheel is not touched unintentionally.</p> <p>The vehicle has started to skid and ESP[®] has intervened.</p> <p>► Use Active Parking Assist again later (▷ page 164).</p>
Park Assist Inoperative	<p>You have just carried out a large number of turning or parking maneuvers.</p> <p>Active Parking Assist will become available again after approximately ten minutes (▷ page 164).</p> <p>► Pull over and stop the vehicle safely as soon as possible, paying attention to road and traffic conditions.</p> <p>► Switch off and restart the engine.</p> <p>If the display message continues to be displayed:</p> <p>► Visit a qualified specialist workshop.</p> <p>PARKTRONIC is defective.</p> <p>► Visit a qualified specialist workshop.</p>
DISTRONIC PLUS Off	<p>DISTRONIC PLUS has been deactivated (▷ page 152). If it was deactivated automatically, a warning tone also sounds.</p>
DISTRONIC PLUS Now Available	<p>DISTRONIC PLUS is operational again after having been temporarily unavailable. You can now reactivate DISTRONIC PLUS (▷ page 152).</p>









Display messages	Possible causes/consequences and ► Solutions
<p>DISTRONIC PLUS Currently Unavailable See Operator's Manual</p>	<p>DISTRONIC PLUS is temporarily inoperative. Possible causes are:</p> <ul style="list-style-type: none"> • function is impaired due to heavy rain or snow. • the sensors in the bumpers are dirty. • the radar sensor system is temporarily inoperative, e.g. due to electromagnetic radiation emitted by nearby TV or radio stations or other sources of electromagnetic radiation. • the system is outside the operating temperature range. • the on-board voltage is too low. <p>A warning tone also sounds.</p> <p>When the causes stated above no longer apply, the display message disappears.</p> <p>DISTRONIC is operational again.</p> <p>If the display message does not disappear:</p> <ul style="list-style-type: none"> ► Pull over and stop the vehicle safely as soon as possible, paying attention to road and traffic conditions. ► Secure the vehicle against rolling away (▷ page 141). ► Clean the sensors in the radiator trim (▷ page 269). ► Restart the engine.
<p>DISTRONIC PLUS Inoperative</p>	<p>DISTRONIC PLUS is defective. Adaptive Brake Assist may also have failed.</p> <p>A warning tone also sounds.</p> <ul style="list-style-type: none"> ► Visit a qualified specialist workshop.
<p>DISTRONIC PLUS Passive</p>	<p>You have depressed the accelerator pedal. DISTRONIC PLUS is no longer controlling the speed of the vehicle.</p> <ul style="list-style-type: none"> ► Remove your foot from the accelerator pedal.
<p>DISTRONIC PLUS --- mph</p>	<p>An activation condition for DISTRONIC PLUS is not fulfilled.</p> <ul style="list-style-type: none"> ► Check the activation conditions for DISTRONIC PLUS (▷ page 154).

Display messages	Possible causes/consequences and ► Solutions
Cruise Control Inoperative	Cruise control is defective. A warning tone also sounds. ► Visit a qualified specialist workshop.
Cruise Control --- mph	A condition for activating cruise control has not been fulfilled. You have tried to store a speed below 20 mph (30 km/h), for example. ► If conditions permit, drive faster than 20 mph (30 km/h) and store the speed. ► Check the activation conditions for cruise control (> page 150).

Tires	
Display messages	Possible causes/consequences and ► Solutions
Check Tire Pressure Soon	<p>The tire pressure loss warning system has detected a significant loss in pressure. A warning tone also sounds.</p> <p> WARNING</p> <p>With tire pressures which are too low, there is a risk of the following hazards:</p> <ul style="list-style-type: none"> • they may burst, especially as the load and vehicle speed increase. • they may wear excessively and/or unevenly, which may greatly impair tire traction. • the driving characteristics, as well as steering and braking, may be greatly impaired. <p>There is a risk of an accident.</p> <ul style="list-style-type: none"> ► Stop the vehicle without making any sudden steering or braking maneuvers. Pay attention to the traffic conditions as you do so. ► Secure the vehicle against rolling away (▷ page 141). ► If there is a flat tire, inspect the tires (▷ page 275). ► Check the tire pressures and, if necessary, correct the tire pressure. ► Restart the tire pressure loss warning system when the tire pressure is correct (▷ page 299).
Check Tire Pressure Then Restart Run Flat Indicator	<p>The tire pressure loss warning system generated a display message and has not been restarted since.</p> <ul style="list-style-type: none"> ► Set the correct tire pressure in all four tires. ► Restart the tire pressure loss warning system (▷ page 299).
Run Flat Indicator Inoperative	<p>The tire pressure loss warning system is faulty.</p> <ul style="list-style-type: none"> ► Visit a qualified specialist workshop.



Vehicle	
Display messages	Possible causes/consequences and ► Solutions
Shift to 'P' or 'N' to Start Engine	<p>You have attempted to start the engine with the transmission in position R or D.</p> <ul style="list-style-type: none"> ► Shift the transmission to position P or N.
Auxiliary Battery Malfunction	<p>The auxiliary battery for the automatic transmission is no longer being charged.</p> <ul style="list-style-type: none"> ► Visit a qualified specialist workshop at the next opportunity. ► Until then, set the automatic transmission to position P before you switch off the engine. ► Before leaving the vehicle, apply the electric parking brake.
Depress Brake to Start Engine	<p>You have attempted to start the engine with the transmission in position N without depressing the brake pedal.</p> <ul style="list-style-type: none"> ► Depress the brake pedal.
To Deselect P or N, Depress Brake and Start Engine	<p>You have attempted to shift the transmission to position R or D without starting the engine.</p> <ul style="list-style-type: none"> ► Start the engine. ► Depress the brake pedal. <p>i It is only possible to shift the transmission from position P to the desired position if you depress the brake pedal. Only then can the parking lock be deactivated. If you do not depress the brake pedal, you can move the DIRECT SELECT lever but the parking lock remains engaged.</p> <p>i At transmission fluid temperatures below -4 °F (-20 °C) you can only shift out of position P into another transmission position when the engine is running.</p>
Apply Brake to Shift from 'P'	<p>You have attempted to move the transmission selector lever to position R, N or D without depressing the brake pedal.</p> <ul style="list-style-type: none"> ► Depress the brake pedal.
Transmission Not in P Risk of Vehicle Rolling Away	<p>The driver's door is open and the transmission is in position R, N or D.</p> <p>A warning tone also sounds.</p> <ul style="list-style-type: none"> ► Shift the transmission to position P. ► Secure the vehicle against rolling away (▷ page 141).

Display messages	Possible causes/consequences and ► Solutions
Service Required Do Not Shift Gears Visit Dealer	<p>You cannot change the transmission position due to a malfunction. A warning tone also sounds.</p> <p>If transmission position D is selected:</p> <ul style="list-style-type: none"> ► Drive to a qualified specialist workshop without shifting the transmission from position D. <p>If transmission position R, N or P is selected:</p> <ul style="list-style-type: none"> ► Notify a qualified specialist workshop or breakdown service.
Only Shift to 'P' when Vehicle is Stationary	<p>The vehicle is moving.</p> <ul style="list-style-type: none"> ► Pull over and stop the vehicle safely as soon as possible, paying attention to road and traffic conditions. ► Shift the transmission to position P.
Reversing Not Possible Service Required	<p>The automatic transmission is malfunctioning. You cannot back up.</p> <ul style="list-style-type: none"> ► Visit a qualified specialist workshop.
Transmission Malfunction	<p>The automatic transmission is malfunctioning.</p> <ul style="list-style-type: none"> ► Visit a qualified specialist workshop.
Transmission Malfunction Stop	<p>The automatic transmission is malfunctioning.</p> <ul style="list-style-type: none"> ► Pull over and stop the vehicle safely as soon as possible, paying attention to road and traffic conditions. ► Secure the vehicle against rolling away (▷ page 141). ► Consult a qualified specialist workshop.
Stop Vehicle Shift to P Leave Engine Running	<p>The automatic transmission has overheated.</p> <ul style="list-style-type: none"> ► Drive on carefully. <p>The automatic transmission is available again when the display message goes out.</p> <p>If the display message continues to be displayed:</p> <ul style="list-style-type: none"> ► Pull over and stop the vehicle safely as soon as possible, paying attention to road and traffic conditions. ► Secure the vehicle against rolling away (▷ page 141). ► Wait until the automatic transmission has cooled down and the display message has disappeared.

Display messages	Possible causes/consequences and ► Solutions
	<p>The tailgate is open.</p> <p> WARNING</p> <p>When the engine is running, exhaust gases can enter the vehicle interior if the tailgate is open.</p> <p>There is a risk of poisoning.</p> <p>► Close the tailgate.</p>
	<p>The hood is open.</p> <p> WARNING</p> <p>The open hood may block your view when the vehicle is in motion.</p> <p>There is a risk of an accident.</p> <p>► Pull over and stop the vehicle safely as soon as possible, paying attention to road and traffic conditions.</p> <p>► Apply the electric parking brake.</p> <p>► Close the hood.</p>
	<p>At least one door is open. A warning tone also sounds.</p> <p>► Close all the doors.</p>
 <p>Power Steering Malfunction See Operator's Manual</p>	<p>The power steering is malfunctioning.</p> <p>A warning tone also sounds.</p> <p> WARNING</p> <p>You will need to use more force to steer.</p> <p>There is a risk of an accident.</p> <p>► Check whether you are able to apply the extra force required.</p> <p>► If you are able to steer safely: carefully drive on to a qualified specialist workshop.</p> <p>► If you are unable to steer safely: do not drive on. Contact the nearest qualified specialist workshop.</p>
<p>Phone No Service</p>	<p>Your vehicle is outside the network provider's transmitter/receiver range.</p> <p>► Wait until the mobile phone operational readiness symbol appears in the multifunction display.</p>
 <p>Check Washer Fluid</p>	<p>The washer fluid level in the washer fluid reservoir has dropped below the minimum.</p> <p>► Add washer fluid (> page 263).</p>



Display messages	Possible causes/consequences and ► Solutions
Wiper Malfunctioning	The windshield wipers are malfunctioning. ► Visit a qualified specialist workshop.
Hazard Warning Flashers Malfunctioning	The hazard warning lamps are faulty. ► Visit a qualified specialist workshop.



SmartKey

Display messages	Possible causes/consequences and ► Solutions
 Key Does Not Belong to Vehicle	You have put the wrong SmartKey in the ignition lock. ► Use the correct SmartKey.
 Take Your Key from Ignition	The SmartKey is in the ignition lock. ► Remove the SmartKey.
 Obtain a New Key	The SmartKey needs to be replaced. ► Visit a qualified specialist workshop.





Warning and indicator lamps in the instrument cluster



Seat belts





Problem	Possible causes/consequences and ► Solutions
 After starting the engine, the red seat belt warning lamp lights up for six seconds.	The seat belt warning lamp reminds the driver and front passenger to fasten their seat belts. ► Fasten your seat belt (▷ page 43).
 After starting the engine, the red seat belt warning lamp lights up. In addition, a warning tone sounds for up to six seconds.	The driver's seat belt is not fastened. ► Fasten your seat belt (▷ page 43). The warning tone ceases.



Problem	Possible causes/consequences and ► Solutions
 <p>The red seat belt warning lamp lights up after the engine starts, as soon as the driver's or the front-passenger door is closed.</p>	<p>The driver or front passenger has not fastened their seat belt.</p> <ul style="list-style-type: none"> ► Fasten your seat belt (▷ page 43). The warning lamp goes out. <p>There are objects on the front-passenger seat.</p> <ul style="list-style-type: none"> ► Remove the objects from the front-passenger seat and stow them in a secure place. The warning lamp goes out.
 <p>The red seat belt warning lamp flashes and an intermittent audible warning sounds.</p>	<p>The driver or front passenger has not fastened their seat belt. In addition, you are driving faster than 15 mph (25 km/h) or you have briefly driven faster than 15 mph (25 km/h).</p> <ul style="list-style-type: none"> ► Fasten your seat belt (▷ page 43). The warning lamp goes out and the intermittent warning tone ceases. <p>There are objects on the front-passenger seat. In addition, you are driving faster than 15 mph (25 km/h) or you have briefly driven faster than 15 mph (25 km/h).</p> <ul style="list-style-type: none"> ► Remove the objects from the front-passenger seat and stow them in a secure place. The warning lamp goes out and the intermittent warning tone ceases.



Safety systems



Problem	Possible causes/consequences and ► Solutions
 <p>The red brake system warning lamp comes on while the engine is running. A warning tone also sounds.</p>	<p>There is not enough brake fluid in the brake fluid reservoir.</p> <p> WARNING</p> <p>The braking effect may be impaired. There is a risk of an accident.</p> <ul style="list-style-type: none"> ► Pull over and stop the vehicle safely as soon as possible, paying attention to road and traffic conditions. Do not continue driving under any circumstances. ► Secure the vehicle against rolling away (▷ page 141). ► Do not add brake fluid. Topping up will not remedy the malfunction. ► Consult a qualified specialist workshop. ► Observe the additional display messages in the multifunction display.
 <p>The yellow ABS warning lamp is lit while the engine is running.</p>	<p>ABS (Anti-lock Brake System) is deactivated due to a malfunction. BAS (Brake Assist), COLLISION PREVENTION ASSIST, ESP® (Electronic Stability Program), PRE-SAFE®, the HOLD function and hill start assist, for example, are therefore also deactivated. ATTENTION ASSIST is deactivated.</p> <p> WARNING</p> <p>The brake system continues to function normally, but without the functions listed above. The wheels could therefore lock if you brake hard, for example.</p> <p>The steerability and braking characteristics may be severely affected. The braking distance in an emergency braking situation can increase.</p> <p>If ESP® is not operational, ESP® is unable to stabilize the vehicle. There is an increased risk of skidding and an accident.</p> <ul style="list-style-type: none"> ► Observe the additional display messages in the multifunction display. ► Drive on carefully. ► Visit a qualified specialist workshop. <p>If the ABS control unit is faulty, there is also a possibility that other systems, such as the navigation system or the automatic transmission, will not be available.</p>





Problem	Possible causes/consequences and ► Solutions
 <p>The yellow ABS warning lamp is lit while the engine is running.</p>	<p>ABS is temporarily unavailable. BAS, COLLISION PREVENTION ASSIST, ESP[®], EBD (electronic brake force distribution), PRE-SAFE[®], the HOLD function and hill start assist, for example, are therefore also deactivated.</p> <p>Possible causes are:</p> <ul style="list-style-type: none"> • Self-diagnosis is not yet complete. • The on-board voltage may be insufficient. <p>ATTENTION ASSIST is deactivated.</p> <p> WARNING</p> <p>The brake system continues to function normally, but without the functions listed above. The front and rear wheels could therefore lock if you brake hard, for example.</p> <p>The steerability and braking characteristics may be severely affected. The braking distance in an emergency braking situation can increase.</p> <p>If ESP[®] is not operational, ESP[®] is unable to stabilize the vehicle. There is a risk of an accident.</p> <ul style="list-style-type: none"> ► Carefully drive a short distance on a suitable stretch of road, making slight steering movements at a speed above 12 mph (20 km/h). The functions mentioned above are available again when the warning lamp goes out. <p>If the warning lamp is still on:</p> <ul style="list-style-type: none"> ► Observe the additional display messages in the multifunction display. ► Drive on carefully. ► Visit a qualified specialist workshop.



Problem	Possible causes/consequences and ► Solutions
 <p>The yellow ABS warning lamp is lit while the engine is running. A warning tone also sounds.</p>	<p>EBD is malfunctioning. Therefore, ABS, BAS, COLLISION PREVENTION ASSIST, ESP[®], PRE-SAFE[®], the HOLD function and hill-start assist are also not available, for example. ATTENTION ASSIST is deactivated.</p> <p> WARNING</p> <p>The brake system continues to function normally, but without the functions listed above. The front and rear wheels could therefore lock if you brake hard, for example.</p> <p>The steerability and braking characteristics may be severely affected. The braking distance in an emergency braking situation can increase.</p> <p>If ESP[®] is not operational, ESP[®] is unable to stabilize the vehicle. There is an increased risk of skidding and an accident.</p> <ul style="list-style-type: none"> ► Observe the additional display messages in the multifunction display. ► Drive on carefully. ► Visit a qualified specialist workshop.
 <p>The red brake warning lamp, the yellow ESP[®] and ESP[®] OFF warning lamps and the yellow ABS warning lamp are lit while the engine is running.</p>	<p>ABS and ESP[®] are malfunctioning. Therefore, BAS, COLLISION PREVENTION ASSIST, EBD, PRE-SAFE[®], the HOLD function and hill-start assist, for example, are not available either. ATTENTION ASSIST is deactivated.</p> <p> WARNING</p> <p>The brake system continues to function normally, but without the functions listed above. The front and rear wheels could therefore lock if you brake hard, for example.</p> <p>The steerability and braking characteristics may be severely affected. The braking distance in an emergency braking situation can increase.</p> <p>If ESP[®] is not operational, ESP[®] is unable to stabilize the vehicle. There is an increased risk of skidding and an accident.</p> <ul style="list-style-type: none"> ► Observe the additional display messages in the multifunction display. ► Drive on carefully. ► Visit a qualified specialist workshop.

Problem	Possible causes/consequences and ► Solutions
 <p>The yellow ESP[®] warning lamp flashes while the vehicle is in motion.</p>	<p>ESP[®] or traction control has intervened because there is a risk of skidding or at least one wheel has started to spin. Cruise control or DISTRONIC PLUS is deactivated.</p> <ul style="list-style-type: none"> ► When pulling away, only depress the accelerator pedal as far as necessary. ► Ease off the accelerator pedal while the vehicle is in motion. ► Adapt your driving style to suit the road and weather conditions. ► Do not deactivate ESP[®]. <p>For exceptions, see: (► page 63).</p>
 <p>The yellow ESP[®] OFF warning lamp is lit while the engine is running.</p>	<p>ESP[®] and ESP[®] trailer stabilization are deactivated. ESP[®] will not stabilize the vehicle if it starts to skid or if a wheel starts to spin.</p> <p>⚠ WARNING</p> <p>If ESP[®] is switched off, ESP[®] is unable to stabilize the vehicle. There is an increased risk of skidding and an accident.</p> <ul style="list-style-type: none"> ► Reactivate ESP[®]. <p>For exceptions, see: (► page 63).</p> <ul style="list-style-type: none"> ► Adapt your driving style to suit the road and weather conditions. <p>If ESP[®] cannot be activated:</p> <ul style="list-style-type: none"> ► Have ESP[®] checked at a qualified specialist workshop.
 <p>The yellow ESP[®] and ESP[®] OFF warning lamps are lit while the engine is running.</p>	<p>ESP[®], BAS, COLLISION PREVENTION ASSIST, PRE-SAFE[®], the HOLD function and hill start assist are unavailable due to a malfunction. ATTENTION ASSIST is deactivated.</p> <p>⚠ WARNING</p> <p>The brake system continues to function normally, but without the functions listed above. The braking distance in an emergency braking situation can thus increase.</p> <p>If ESP[®] is not operational, ESP[®] is unable to stabilize the vehicle. There is an increased risk of skidding and an accident.</p> <ul style="list-style-type: none"> ► Observe the additional display messages in the multifunction display. ► Drive on carefully. ► Visit a qualified specialist workshop.

Problem	Possible causes/consequences and ► Solutions
 <p>The yellow ESP[®] and ESP[®] OFF warning lamps are lit while the engine is running.</p>	<p>ESP[®], BAS, PRE-SAFE[®], the HOLD function and hill start assist are temporarily unavailable. COLLISION PREVENTION ASSIST may also have failed. ATTENTION ASSIST is deactivated. Self-diagnosis is not yet complete.</p> <p> WARNING</p> <p>The brake system continues to function normally, but without the functions listed above. The braking distance in an emergency braking situation can thus increase. If ESP[®] is not operational, ESP[®] is unable to stabilize the vehicle. There is an increased risk of skidding and an accident.</p> <p>► Carefully drive a short distance on a suitable stretch of road, making slight steering movements at a speed above 12 mph (20 km/h). The functions mentioned above are available again when the warning lamp goes out.</p> <p>If the warning lamp is still on:</p> <ul style="list-style-type: none"> ► Observe the additional display messages in the multifunction display. ► Drive on carefully. ► Visit a qualified specialist workshop.

Problem	Possible causes/consequences and ► Solutions
 <p>The red indicator lamp for the electric parking brake flashes or lights up and/or the yellow warning lamp for the electric parking brake lights up.</p>	<p>► Observe the messages in the multifunction display.</p>
 <p>The red SRS warning lamp is lit while the engine is running.</p>	<p>There is a malfunction in the SRS (Supplemental Restraint System).</p> <p> WARNING</p> <p>The air bags or Emergency Tensioning Devices may either be triggered unintentionally or, in the event of an accident, may not be triggered.</p> <p>There is an increased risk of injury.</p> <ul style="list-style-type: none"> ► Drive on carefully. ► Have SRS checked at a qualified specialist workshop immediately. <p>For further information about SRS, see (► page 37).</p>

Engine	
Problem	Possible causes/consequences and ► Solutions
 <p>The yellow Check Engine warning lamp lights up while the engine is running.</p>	<p>There may be a malfunction, for example:</p> <ul style="list-style-type: none"> • in the engine management • in the fuel injection system • in the exhaust system • in the ignition system • in the fuel system <p>The emission limit values may be exceeded and the engine may be running in emergency mode.</p> <p>► Have the vehicle checked as soon as possible at a qualified specialist workshop.</p> <p>i In some states, you must immediately visit a qualified specialist workshop as soon as the yellow Check Engine warning lamp lights up. This depends on the locally applicable legal requirements. If in doubt, check whether such legal regulations apply in the state in which you are currently driving.</p>
 <p>The yellow reserve fuel warning lamp lights up while the engine is running.</p>	<p>The fuel level has dropped into the reserve range.</p> <p>► Refuel at the nearest gas station.</p>
 <p>The yellow reserve fuel warning lamp flashes while the engine is running.</p>	<p>The fuel system pressure is too low. The fuel filler cap is not closed correctly or the fuel system is leaking.</p> <p>► Check that the fuel filler cap is correctly closed.</p> <p>► If the fuel filler cap is not correctly closed: close the fuel filler cap.</p> <p>► If the fuel filler cap is closed: visit a qualified specialist workshop.</p>
 <p>The red coolant warning lamp lights up while the engine is running and the coolant temperature gage is at the start of the scale.</p>	<p>The temperature sensor for the coolant temperature gage is defective.</p> <p>The coolant temperature is no longer being monitored. There is a risk of engine damage if the coolant temperature is too high.</p> <p>► Pull over and stop the vehicle safely and switch off the engine, paying attention to road and traffic conditions. Do not continue driving under any circumstances.</p> <p>► Secure the vehicle against rolling away (► page 141).</p> <p>► Consult a qualified specialist workshop.</p>

Problem	Possible causes/consequences and ► Solutions
 <p>The red coolant warning lamp comes on while the engine is running.</p>	<p>The coolant level is too low.</p> <p>If the coolant level is correct, the airflow to the engine radiator may be blocked or the electric engine radiator fan may be malfunctioning.</p> <p>The coolant is too hot and the engine is no longer being cooled sufficiently.</p> <ul style="list-style-type: none"> ► Observe the additional display messages in the multifunction display. ► Pull over and stop the vehicle safely and switch off the engine, paying attention to road and traffic conditions. ► Secure the vehicle against rolling away (► page 141). ► Leave the vehicle and keep a safe distance from the vehicle until the engine has cooled down. ► Check the coolant level and add coolant (► page 263). Observe the warning notes. ► If you need to add coolant more often than usual, have the engine coolant system checked. ► Make sure that the air supply to the engine radiator is not blocked, e.g. by snow, slush or ice. ► Do not start the engine again until the coolant temperature is under 248 °F (120 °C). Otherwise, the engine could be damaged. ► Drive to the nearest qualified specialist workshop. ► Avoid subjecting the engine to heavy loads, e.g. driving in mountainous terrain, and stop-and-go traffic.
 <p>The red coolant warning lamp comes on while the engine is running. A warning tone also sounds.</p>	<p>The coolant temperature has exceeded 248 °F (120 °C). The airflow to the engine radiator may be blocked or the coolant level may be too low.</p> <p> WARNING</p> <p>The engine is not being cooled sufficiently and may be damaged. Do not drive when your engine is overheated. This can cause some fluids which may have leaked into the engine compartment to catch fire.</p> <p>Vapor from the overheated engine can also cause serious burns which can occur just by opening the hood.</p> <p>There is a risk of injury.</p> <ul style="list-style-type: none"> ► Observe the additional display messages in the multifunction display. ► Pull over and stop the vehicle safely and switch off the engine, paying attention to road and traffic conditions. ► Secure the vehicle against rolling away (► page 141).

Problem	Possible causes/consequences and ► Solutions
	<ul style="list-style-type: none"> ▶ Leave the vehicle and keep a safe distance from the vehicle until the engine has cooled down. ▶ Check the coolant level and add coolant (▷ page 263). Observe the warning notes. ▶ If you need to add coolant more often than usual, have the engine coolant system checked. ▶ Make sure that the air supply to the engine radiator is not blocked, e.g. by snow, slush or ice. ▶ At coolant temperatures under 248 °F (120 °C), drive to the next qualified specialist workshop. ▶ Avoid subjecting the engine to heavy loads, e.g. driving in mountainous terrain, and stop-and-go traffic.

Driving systems

Problem	Possible causes/consequences and ► Solutions
 <p>The red distance warning lamp lights up while the vehicle is in motion. A warning tone also sounds.</p>	<p>You are approaching a vehicle or a stationary obstacle in your line of travel at too high a speed.</p> <ul style="list-style-type: none"> ▶ Be prepared to brake immediately. ▶ Pay careful attention to the traffic situation. You may have to brake or take evasive action.

Useful information	230
Loading guidelines	230
Stowage areas	230
Features	241

Useful information

- i** This Operator's Manual describes all models and all standard and optional equipment of your vehicle available at the time of publication of the Operator's Manual. Country-specific differences are possible. Please note that your vehicle may not be equipped with all features described. This also applies to safety-related systems and functions.
- i** Please read the information on qualified specialist workshops (▷ page 23).

Loading guidelines

WARNING

Always fasten items being carried as securely as possible using cargo tie-down rings and fastening materials appropriate for the weight and size of the load.

In an accident, during hard braking or sudden maneuvers, loose items will be thrown around inside the vehicle. This can cause injury to vehicle occupants unless the items are securely fastened in the vehicle.

To help avoid personal injury during a collision or sudden maneuver, exercise care when transporting cargo. Do not pile luggage or cargo higher than the seat backrests.

Never drive a vehicle with the tailgate open. Deadly carbon monoxide (CO) gases may enter vehicle interior resulting in unconsciousness and death.

The handling characteristics of a laden vehicle are dependent on the distribution of the load within the vehicle. For this reason, you should observe the following notes when transporting a load:

- when transporting a load, never exceed the maximum permissible gross vehicle weight or the gross axle weight rating of the vehicle (including occupants). The values

are specified on the vehicle identification plate on the B-pillar of the driver's door.

- position heavy loads as far forwards as possible and as low down in the cargo compartment as possible.
- the load must not protrude above the upper edge of the seat backrests.
- always place the load against the rear or front seat backrests. Make sure that the seat backrests are securely locked into place.
- hook in the cargo net when loading.
- the maximum load capacity of the stowage well under the cargo compartment floor is 55 lbs (25 kg).
- always place the load behind unoccupied seats if possible.
- secure the load with sufficiently strong and wear-resistant tie-downs. Pad sharp edges for protection.

- !** Do not position the load on one part of the folding cargo compartment floor only. The maximum load capacity of the folding cargo compartment floor is 220 lbs (100 kg). Distribute the weight evenly to avoid damaging the cargo compartment floor. Place a solid board under the load if necessary. Please note that the load on the cargo compartment floor will be increased when the load is lashed down.

Stowage areas

Stowage space

Important safety notes

WARNING

To help avoid personal injury during a collision or sudden maneuver, exercise care when storing objects in the vehicle. Put luggage or cargo in the cargo compartment if possible. Do not pile luggage or cargo higher than the seat backrests.

Keep compartment lids closed. This will help to prevent stored objects from being thrown about and injuring vehicle occupants during

- braking
- vehicle maneuvers
- an accident

Stowage compartments in the front

Glove box

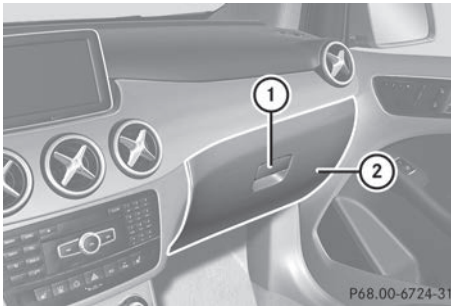

► **To open:** pull handle ① and open glove box flap ②.

► **To close:** fold glove box flap ② upwards until it engages.

i There is a pen holder at the top of the glove box flap.

Eyeglasses compartment

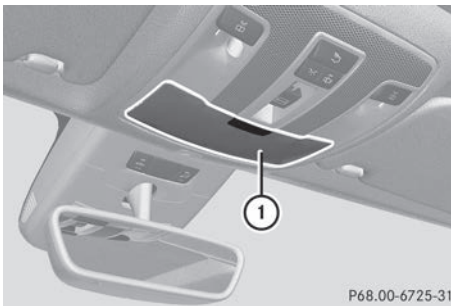

► **To open:** press marking ①.

Make sure that the eyeglasses compartment is always closed while the vehicle is in motion.

Stowage compartment in the center console



► **To open:** press the marking on cover ①.

i Depending on the vehicle's equipment, there is an open instead of a closed stowage compartment or an ashtray in the center console.

Stowage compartment in front of the armrest (vehicles with automatic transmission)



► **To open:** press the marking on cover ①.

i You can remove the non-slip mat and the insert for cleaning. When removing the insert, you will encounter a small amount of resistance.

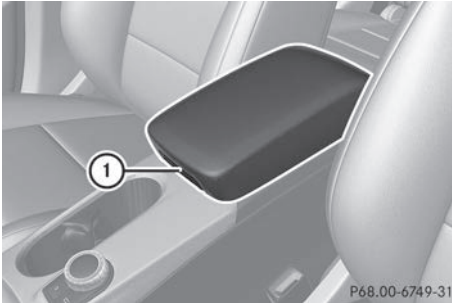
Storage compartment under the armrest

- ▶ **To open:** on vehicles with moveable armrests, make sure that the armrest is in the rearmost position.
- ▶ Press button ① and fold the armrest up.

i Depending on the vehicle's equipment, a USB connection and an AUX IN connection or a Media Interface are installed in the storage compartment. A Media Interface is a universal interface for mobile audio equipment, e.g. for an iPod® or MP3 player (see the separate COMAND Operating Instructions).

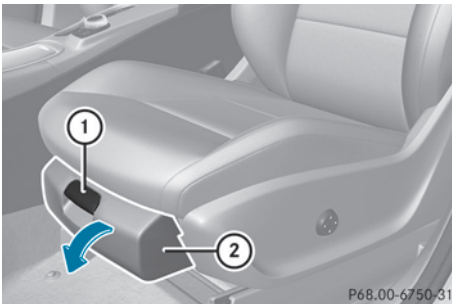
Storage compartment under the driver's seat and front-passenger seat

- ▶ **To open:** pull handle ① up and fold cover ② forwards.

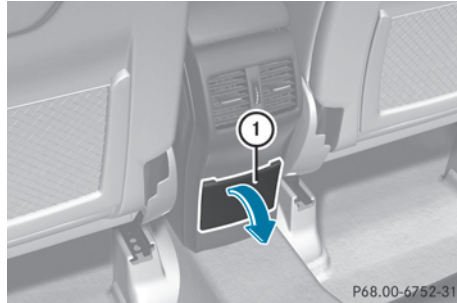
Storage space in the rear**Storage compartment in the rear center console**

- ▶ **To open:** pull down the top of storage compartment ① by the edge of the handle.

i Depending on the vehicle's equipment, there may be an open storage space above the storage compartment.

Folding table**⚠ WARNING**

Keep the folding table closed while the vehicle is in motion. Otherwise, you could be injured by objects on the table, or by the folding table itself, in the event of sharp braking, a sudden change in direction or an accident.

- !** Do not load the folding table with more than the maximum permissible load of 4.4 lbs (2 kg).

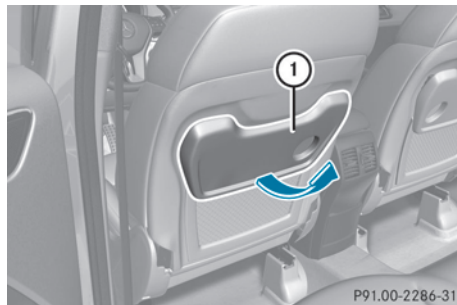

- ▶ **To fold out:** pull folding table ① up in the direction of the arrow to the desired position.
- ▶ **To fold away:** push folding table ① down onto the backrest.

Parcel nets

WARNING

Parcel nets are intended for storing light-weight items only, such as road maps, mail, etc.

Heavy objects, objects with sharp edges, or fragile objects may not be transported in the parcel nets. In an accident, during hard braking, or sudden maneuvers, they could be thrown around inside the vehicle and cause injury to vehicle occupants.

Parcel nets cannot protect transported goods in the event of an accident.

- ❗ The maximum load that may be placed on the parcel net under the rear shelf is 2.5 kg.

Parcel nets are located in the front-passenger footwell and on the back of the driver's and the front-passenger seat.

Folding backrest on the front-passenger seat

WARNING

In the event of an accident, sudden braking or an abrupt change of direction, people sitting in the back may be endangered by protruding parts of the folded front-passenger seat if the backrest of the front-passenger seat is folded forward. There is an increased risk of injury.

Make sure that there are no people on the center rear seat or on the rear seat behind the front-passenger seat, while the front-passenger seat is folded.

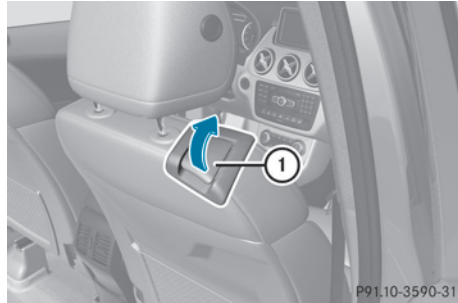

- ▶ **To fold forward:** gently push the backrest back.
- ▶ Pull release handle ① and fold the backrest fully onto the seat cushion until it engages.
- ▶ **To fold back:** gently push the backrest down and pull release handle ①.
- ▶ Fold the seat backrest back until it engages.

Through-loading facility in the rear compartment

WARNING

Do not transport any unsecured items in the through-loading area.

WARNING

Do not drive without the armrest locked in place. You and others could otherwise be injured by the armrest should it be thrown around in the event of an accident, strong braking maneuvers or sudden changes of direction.

No passengers may sit in the rear center seat when the armrest has been removed.

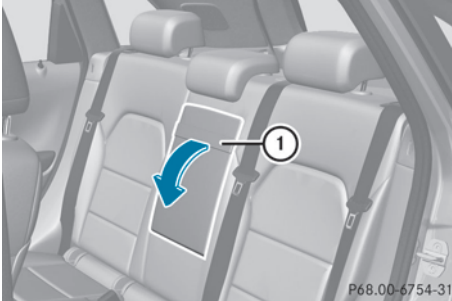

- ▶ **To open:** fold down seat armrest ①.
- ▶ Pull the cover, which can now be seen, forwards by the grip until it lies on armrest ①.
- ▶ Pull the center head restraint on the rear bench seat into the uppermost position (> page 87).

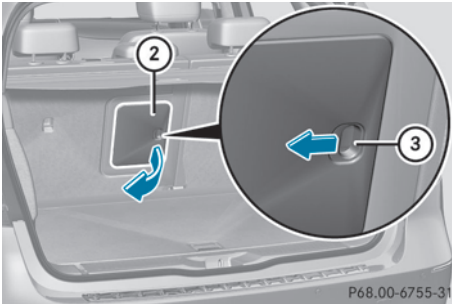

- ▶ Slide locking mechanism ③ in the direction of the arrow.
- ▶ Swing flap ② fully to the side. Flap ② is held open by a magnet.
- ▶ **To close:** swing flap ② in the cargo compartment back until it engages.
- ▶ Fold the cover forwards until it engages into armrest ①.
- ▶ Fold armrest ① up fully if necessary.

Cargo compartment enlargement

Important safety notes

WARNING

When expanding the cargo volume, always fully fold the corresponding seats and, if so equipped, always use the cargo net when transporting cargo.

Unless you are transporting cargo, the seat backrests must remain properly locked in the upright position.

In an accident, during hard braking or sudden maneuvers, loose items will be thrown around inside the vehicle. This can cause injury to vehicle occupants unless the items are securely fastened in the vehicle.

Always use the cargo tie-down rings.

WARNING

Never drive a vehicle with the tailgate open. Deadly carbon monoxide (CO) gases may enter vehicle interior resulting in unconsciousness and death.

- ❗ Before folding the backrest in the rear compartment forwards, make sure that the rear compartment armrest and the cupholder are folded in. They may otherwise be damaged.

Vehicles without the EASY-VARIO-PLUS system

Folding the rear seat backrest forward

The left-hand and right-hand rear seat backrests can be folded forwards separately to increase the cargo compartment capacity.

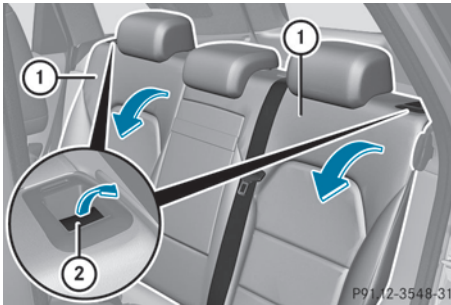

- ▶ Fully insert the backrest head restraints (▷ page 87).
- ▶ Move the driver's or front-passenger seat forward if necessary.
- ▶ Pull left-hand or right-hand release handle (2) of the seat backrest forwards. Corresponding seat backrest (1) is released.
- ▶ Fold backrest (1) forwards.
- ▶ Move the driver's or front-passenger seat back if necessary.

Folding the rear seat backrest back

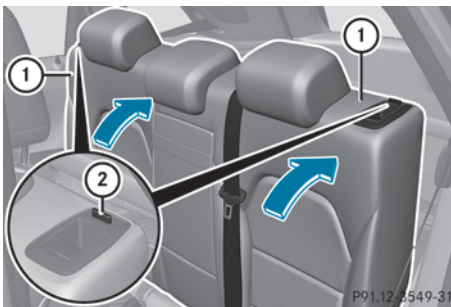

- ▶ Move the driver's or front-passenger seat forward if necessary.
- ❗ Make sure that the seat belt does not become trapped when folding the rear seat backrest back. Otherwise, it could be damaged.
- ▶ Fold seat backrest (1) back until it engages. Red lock status indicator (2) is no longer visible.

⚠ WARNING

If a red indicator is visible with the seat backrest up, then the seat backrest is not properly locked into position.

Always lock seat backrest in its upright position when rear seat bench is occupied, or the expanded cargo volume is not in use.

Check for secure locking by pushing and pulling on the seat backrest.

In an accident, during hard braking or sudden maneuvers, loose items will be thrown around inside the vehicle. This can cause injury to vehicle occupants unless the items are securely fastened in the vehicle.

To help avoid personal injury during a collision or sudden maneuver, exercise care when transporting cargo.

- ▶ Adjust the head restraints if necessary (▷ page 87).
- ▶ Move the driver's or front-passenger seat back if necessary.

Vehicles with the EASY-VARIO-PLUS system

Folding the rear seat backrest forward

The left-hand and right-hand rear seat backrests can be folded forwards separately to increase the cargo compartment capacity.

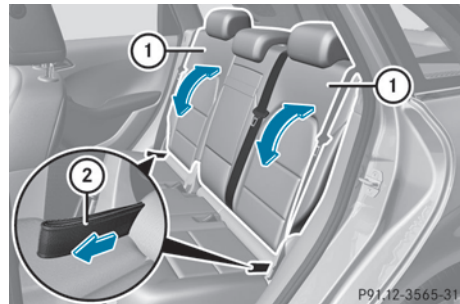

- ▶ Fully insert the backrest head restraints (▷ page 87).
- ▶ Move the rear seat as far back as possible (▷ page 237).

- ▶ Move the driver's or front-passenger seat forward if necessary.
- ▶ Pull right or left loop (2) on the backrest in the direction of the arrow. Corresponding seat backrest (1) is released.
- ▶ Fold down backrest (1) fully.
- ▶ Move the driver's or front-passenger seat back if necessary.

Folding the rear seat backrest back

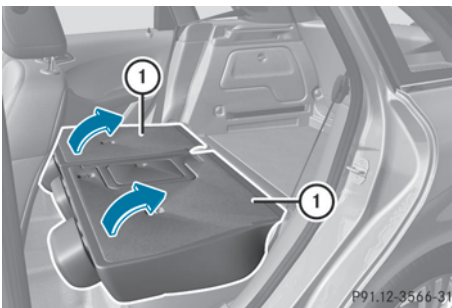

- ▶ Move the driver's or front-passenger seat forward if necessary.
- ❗ Make sure that the seat belt does not become trapped when folding the rear seat backrest back. Otherwise, it could be damaged.
- ▶ Swing backrest (1) back.
- ▶ Adjust the backrest to the desired angle by pulling the loop (▷ page 236).
- ▶ Adjust the head restraints if necessary (▷ page 87).
- ▶ Move the driver's or front-passenger seat back if necessary.

Notes on using the cargo compartment

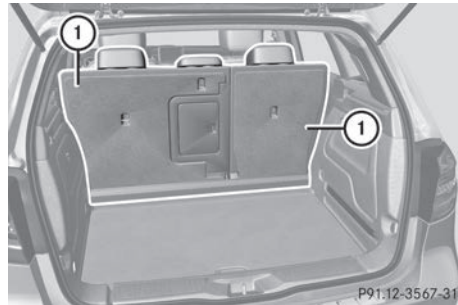

Load position

Making the best use of your cargo compartment:

- Load capacity is increased when backrest (1) is set to the load position (90°) (▷ page 236).
- Vehicles with a height-adjustable trunk floor: a level load surface can be obtained by moving the trunk floor to the upper position (▷ page 240).
- A larger load area can be obtained by moving the rear bench seat as far forward as possible (▷ page 237).
- The load area can be lengthened by folding forward the folding backrest of the front-passenger seat (▷ page 233) and the corresponding backrest in the rear.

Adjusting the angle of the rear seat backrests

You can set the angle of the seat backrests to one of 13 detent positions.

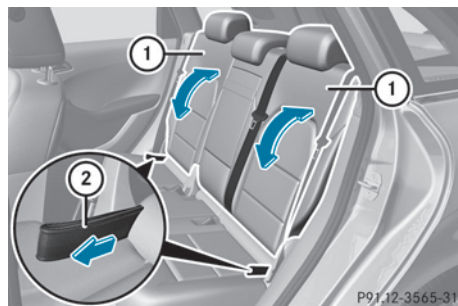

- ▶ Pull right or left release loop ② forwards in the direction of the arrow. Corresponding seat backrest ① is released.
- ▶ Pull backrest ① forward in the direction of the arrow, or push it back and let it engage.
- ▶ To ensure that the backrest has engaged, lean firmly against backrest ①.

Adjusting the seat fore-and-aft position

! When moving the rear seats back, make sure there are no objects in the footwell or behind the seats. The rear seats and/or the objects could otherwise be damaged.

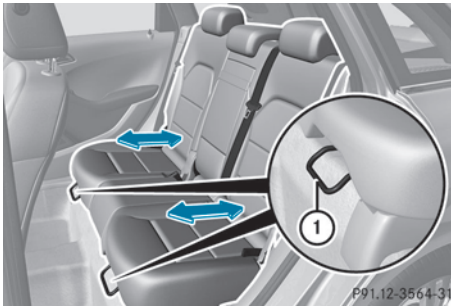

- ▶ Lift the left or right release handle and slide the corresponding seat forwards or backwards.
- ▶ Let go of the release handle again. Make sure that you hear the seat engage in position.

Securing cargo

Cargo tie-down rings

Observe the following notes on securing loads:

- secure the load using the cargo tie-down rings.
- do not use elastic straps or nets to secure a load, as these are only intended as an anti-slip protection for light loads.

- do not route tie-downs across sharp edges or corners.
- pad sharp edges for protection.

There are four cargo tie-down rings in the cargo compartment.

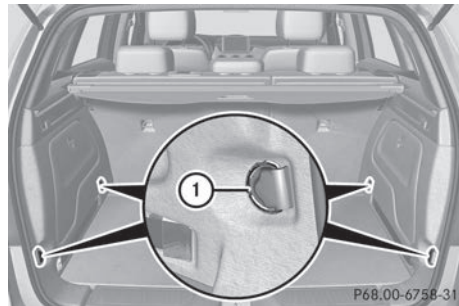

① Cargo tie-down rings

Bag hook

! The bag hook can bear a maximum load of 6.6lbs (3kg) and should not be used to secure a load.

There is one bag hook on either side of the cargo compartment.

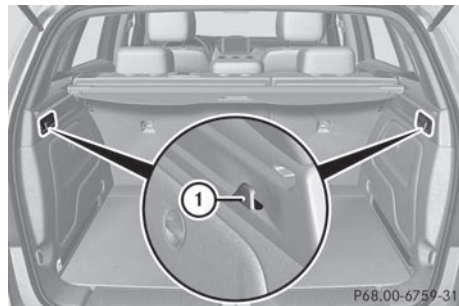

① Bag hook

Cargo compartment cover

Important safety notes

! When loading the vehicle, make sure that you do not stack the load in the cargo compartment higher than the lower edge of the side windows. Do not place heavy

objects on top of the cargo compartment cover.

- ❗ When removing and installing the cargo compartment cover, ensure that its end caps do not scrape the light-colored parts of the vehicle.

The cargo compartment cover is located behind the rear bench seat backrest.

Extending and retracting the cargo compartment cover

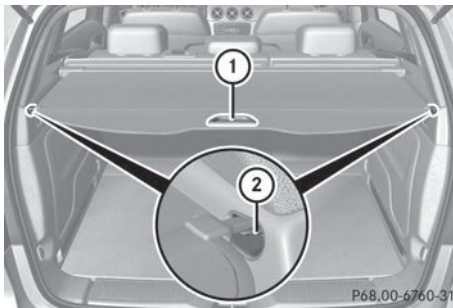

- ▶ **To extend:** pull the cargo compartment cover back by grab handle ① and clip it into retainers ② on the left and right.
- ▶ **To retract:** unhook the cargo compartment cover from retainers ② on the left and right and guide it forwards by grab handle ① until it is fully retracted.

Installing/removing the cargo compartment cover

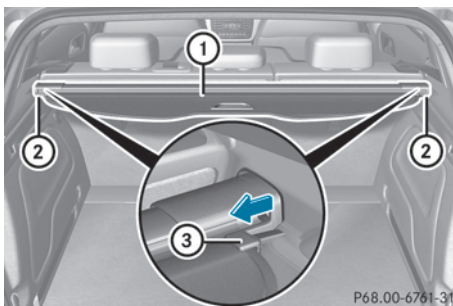

- ▶ **To remove:** make sure that the cargo compartment cover is rolled up.
- ▶ Push in the end cap of cargo compartment cover ① in the direction of the arrow on the right or left side using grip ③.
- ▶ Push cargo compartment cover ① into opposite anchorage ②.
- ▶ Remove cargo compartment cover ① upwards.
- ▶ **To install:** set cargo compartment cover ① on the right or left-hand side in anchorage ②.
- ▶ Push in the opposite end cap of cargo compartment cover ① in the direction of the arrow and insert cargo compartment cover ① into opposite anchorage ②.

Cargo net

Important safety notes

It is particularly important to use a cargo net if the vehicle is loaded with small objects above the level of the backrests. For safety reasons, always use a cargo net when transporting loads.

The cargo net is located in the stowage space under the cargo compartment floor (▷ page 239).

- ▶ Open both Velcro fasteners and remove the cargo net.
- ▶ Unroll and unfold the cargo net.
The joints on the upper and lower guide rod should engage audibly.

The corresponding cargo tie down rings for tightening the cargo net are in the cargo compartment (▷ page 237).

Attaching and tightening the cargo net

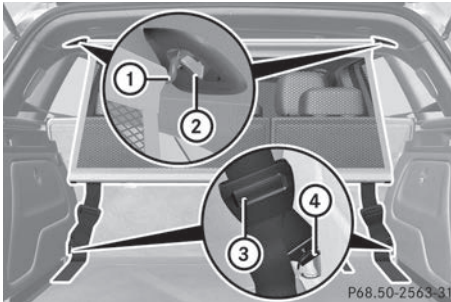

- ▶ **To attach and tighten:** insert guide rod ① into bracket ②.
- ▶ Attach belt hook ④ to the cargo tie-down ring and pull down on the loose end of the lashing strap until the cargo net is taut.
- ▶ After driving a short distance, check the tension of the cargo net and retighten it if necessary.
- ▶ **To loosen and detach:** pull belt clamp ③ up to reduce the tension in the lashing strap.
- ▶ Unhook belt hook ④ from the cargo tie-down ring.
- ▶ Detach guide rod ① from bracket ②.
- ▶ **To stow:** press the red button on the upper and lower guide rod.
- ▶ Fold the cargo net and roll it up.
- ▶ Close the two Velcro fasteners on the cargo net holder.

Stowage well under the cargo compartment floor

Important safety notes

- ❗ The maximum load capacity of the stowage well under the cargo compartment floor is 55 lbs (25 kg).

Opening/closing the trunk floor

A bracket for TIREFIT, the vehicle tool kit, etc. is located underneath the cargo compartment floor.

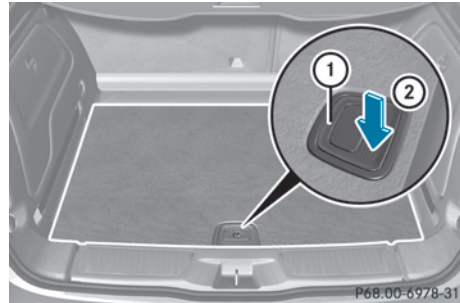

- ▶ **To open:** open the tailgate.
- ▶ Press down handle ① on ribbing ②. Handle ① folds up.
- ▶ Swing the cargo compartment floor upwards using handle ① until it rests against the cargo compartment cover.

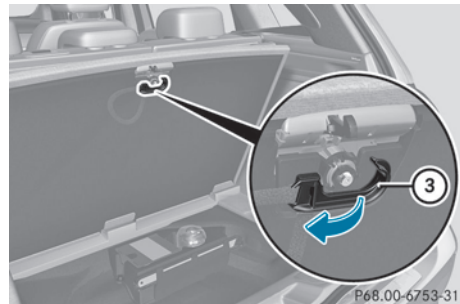

- ▶ Fold out hook ③ on the underside of the cargo compartment floor.

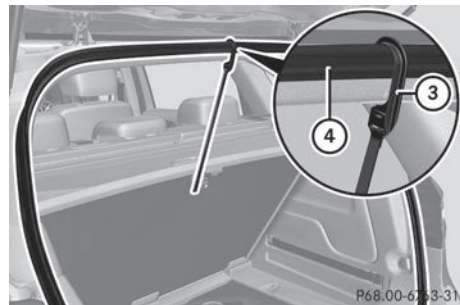

- ▶ Attach hook (3) to the cargo compartment's upper seal (4).
- ▶ **To close:** detach hook (3) from seal (4).
- ▶ Fasten hook (3) to the bracket on the underside of the cargo compartment floor.
- ▶ Fold the trunk floor down.
- ▶ Press the trunk floor down until it engages.

Setting the height of the trunk floor

The stowage well under the trunk floor can be increased or decreased in size as necessary. To do this, you can lock the floor at two different heights. The upper catch gives a flat load surface when the rear bench seat is folded forward.

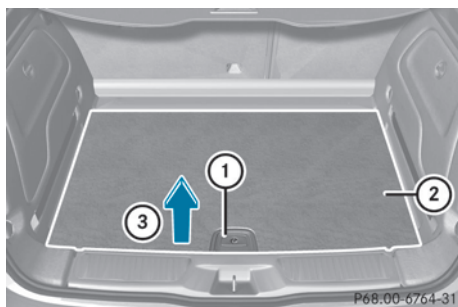

- ▶ **To lift:** raise trunk floor (2) using handle (1) in the direction of arrow (3) and tug it upwards sharply.
- ▶ Lower trunk floor (2) again. To do this, push the trunk floor away so that it engages in the guide on the upper level. Trunk floor (2) engages in the upper position.
- ▶ **To lower:** raise trunk floor (2) slightly using handle (1) and tug it briefly towards you.
- ▶ Lower trunk floor (2) again slowly. Whilst doing so, press the trunk floor into the lower level. Trunk floor (2) engages in the lower position.

Roof carrier

Important safety notes

WARNING

Only use roof racks approved by Mercedes-Benz for your vehicle model to avoid damage to the vehicle.

Follow the manufacturer's installation instructions. Otherwise, an improperly attached roof rack system or its load could become detached from the vehicle.

Do not exceed the maximum roof load of 165 lb (75 kg).

Take into consideration that when the roof rack is loaded, the handling characteristics are different from those when operating the vehicle without the roof rack loaded.

- ❗ Mercedes-Benz recommends that you only use roof carriers that have been tested and approved for Mercedes-Benz vehicles. This helps to prevent damage to the vehicle.

Position the load on the roof rack in such a way that the vehicle will not sustain damage even when it is in motion.

Ensure that, depending on the vehicle's equipment, you can raise the panorama roof with power tilt/sliding panel fully and open the tailgate fully when the roof carrier is installed.

Attaching the roof carrier

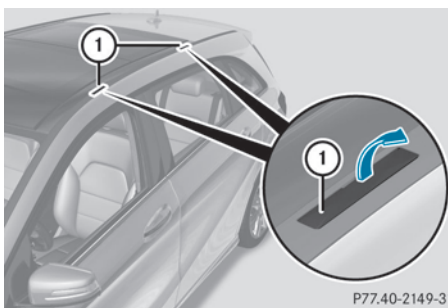

- ▶ Open covers ① carefully in the direction of the arrow.
- ▶ Fold covers ① upwards.
- ▶ Only secure the roof carrier to the anchorage points under covers ①.
- ▶ Observe the manufacturer's installation instructions.

Features

Cup holders

Important safety notes

WARNING

In order to help prevent spilling liquids on vehicle occupants and/or vehicle equipment, only use containers that fit into the cup holder. Use lids on open containers and do not fill containers to a height where the contents, especially hot liquids, could spill during braking, vehicle maneuvers, or in an accident. Liquids spilled on vehicle occupants may cause serious personal injury. Liquids spilled on vehicle equipment may cause damage not covered by the Mercedes-Benz Limited Warranty.

When not in use, keep the cup holder closed. An open cup holder may cause injury to you or others when contacted during braking, vehicle maneuvers, or in an accident.

Keep in mind that objects placed in the cup holder may come loose during braking, vehicle maneuvers, or in an accident and be thrown around in the vehicle interior. Objects thrown around in the vehicle interior may cause an accident and/or serious personal injury.

WARNING

Do not transport any heavy, sharp-edged or fragile bottles in the stowage compartments. In the event of an accident, the stowage compartments cannot secure the bottles adequately. You and/or other vehicle occupants could be injured.

The stowage compartments in the doors provide space for bottles:

- front: capacity up to 51 fl. oz. (1.5 l).
- rear: capacity up to 17 fl. oz. (0.5 l).

The bottles are not secured or prevented from tipping over. Therefore, do not place any open drink containers in the stowage compartments.

Cup holder in the front-compartment center console

The cup holder and the rubber mat underneath can be removed for cleaning. Clean with clear, lukewarm water only.

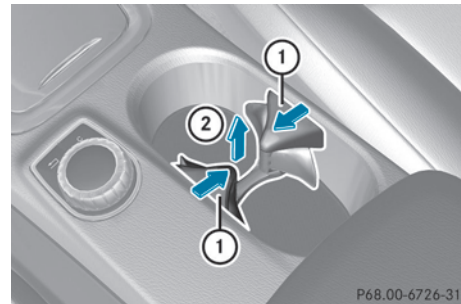

- ▶ **To remove:** carefully pull in the upper sections of cup holders ① on the driver's and front-passenger sides until they release.
- ▶ Lift the cup holder upwards ② until it can be removed.

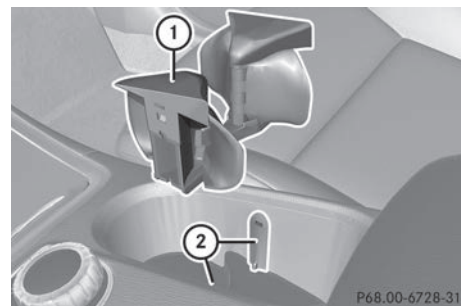

- ▶ **To install:** insert the cup holder into lateral curved sections ② in the stowage compartment. Insert the cup holder so that

the wedge of the upper section of cup holder ① faces forwards.

- ▶ Press the cup holder downwards until it engages on the right and left-hand sides.

Cup holder in the rear seat armrest

! Do not sit on or support your body weight on the rear seat armrest when it is folded down, as you could otherwise damage it.

! Close the cup holder before folding the rear seat armrest up. Otherwise, the cup holder could be damaged.

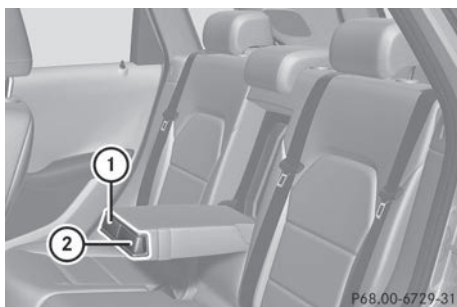

- ▶ Fold down the rear seat armrest.
- ▶ **To open:** press the front of cup holder ① or ②. Cup holder ① or ② extends automatically.
- ▶ **To close:** slide the cup holder back until it engages.

Sun visors

Overview

⚠ WARNING

Do not use the vanity mirror while driving. Keep the vanity mirrors in the sun visors closed while the vehicle is in motion. Reflected glare can endanger you and others.

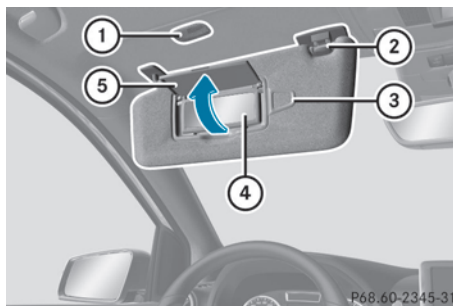

- ① Mirror light
- ② Bracket
- ③ Retaining clip, e.g. for a car park ticket
- ④ Vanity mirror
- ⑤ Mirror cover

Vanity mirror in the sun visor

Mirror light ① only functions if the sun visor is clipped into retainer ② and mirror cover ⑤ has been folded up.

Glare from the side

- ▶ Fold down the sun visor.
- ▶ Pull the sun visor out of retainer ②.
- ▶ Swing the sun visor to the side.
- ▶ **Vehicles with mirror lights:** slide the sun visor horizontally as desired.

Ashtray

Front ashtray

! The stowage space under the ashtray is not heat resistant. Before placing lit cigarettes in the ashtray, make sure that the ashtray is properly engaged. Otherwise, the stowage space could be damaged.

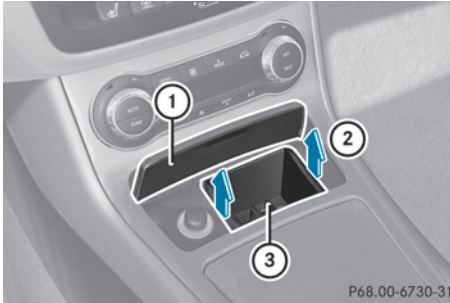

Example: vehicles with a cover over the stowage compartment

- ▶ **To open:** push the lower section of cover ①. The cover opens.
- ▶ **To remove the insert:** lift insert ③ up ② and out.
- ▶ **To re-install the insert:** press insert ③ into the holder until it engages.

i If you remove the ashtray insert, you can use the resulting compartment for stowage.

Rear-compartment ashtray

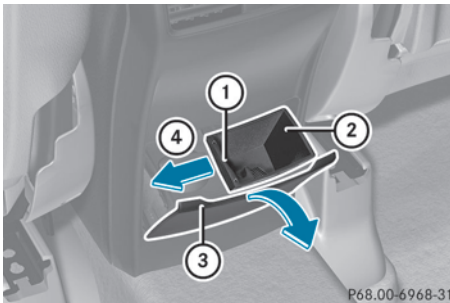

- ▶ **To open:** pull cover ③ out by its top edge.
- ▶ **To remove the insert:** pull insert ② by recess ① in the direction of arrow ④ until it disengages audibly.
- ▶ Lift insert ② up and out.
- ▶ **To install the insert:** install insert ① from above into the holder and press down into the holder until it engages.

Cigarette lighter

⚠ WARNING

When leaving the vehicle, always remove the SmartKey from the starter switch. Always take the SmartKey with you and lock the vehicle. Do not leave children unattended in the vehicle, even if they are secured in a child restraint system, or with access to an unlocked vehicle. A child's unsupervised access to a vehicle could result in an accident and/or serious personal injury. The children could

- injure themselves on parts of the vehicle
- be seriously or fatally injured through excessive exposure to extreme heat or cold
- injure themselves or cause an accident with vehicle equipment that can be operated even if the SmartKey is removed from the starter switch or removed from the vehicle, such as seat adjustment or steering wheel adjustment

If children open a door, they could injure other persons or get out of the vehicle and injure themselves or be injured by following traffic.

Do not expose the child restraint system to direct sunlight. The child restraint system's metal parts, for example, could become very hot, and the child could be burned by these parts.

⚠ WARNING

Never touch the heating element or sides of the lighter; they are extremely hot. Hold the knob only.

Make sure any children traveling with you do not injure themselves or start a fire with the hot cigarette lighter.

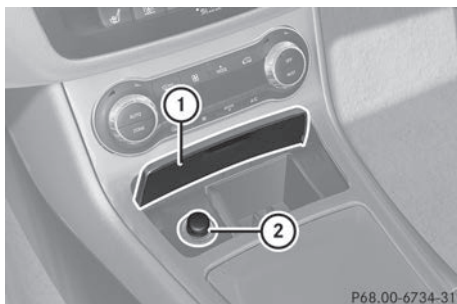

Example: vehicles with a cover over the stowage compartment

- ▶ Turn the SmartKey to position **2** in the ignition lock (▷ page 127).
- ▶ **To open:** push the lower section of cover **①**.
The ashtray opens.
- ▶ Press in cigarette lighter **②**.
Cigarette lighter **②** will pop out automatically when the heating element is red-hot.

12 V sockets

Points to observe before use

- ▶ Turn the SmartKey to position **1** in the ignition lock (▷ page 127).

The sockets can be used for accessories with a maximum draw of 180 W (15 A).

Accessories include such items as lamps or chargers for mobile phones.

If you use the sockets for long periods when the engine is switched off, the battery may discharge.

- i** An emergency cut-out ensures that the on-board voltage does not drop too low. If the on-board voltage is too low, the power to the sockets is automatically cut. This ensures that there is sufficient power to start the engine.

Socket in the front-compartment center console



Vehicles with a cover over the stowage compartment

- ▶ **To open:** push the lower section of cover **①**.
The stowage compartment opens.
- ▶ Lift up the cover of socket **②**.



Vehicles without a cover over the stowage compartment

- ▶ Lift up the cover of socket **①**.

Socket in the rear-compartment center console

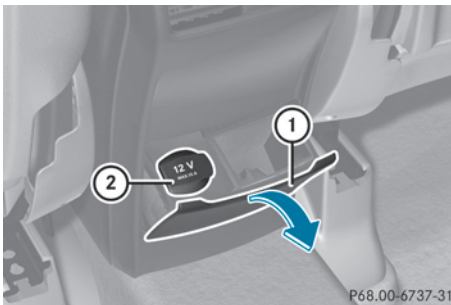

- ▶ Pull cover ② out by its top edge.
- ▶ Lift up the cover of socket ①.

Socket in the cargo compartment

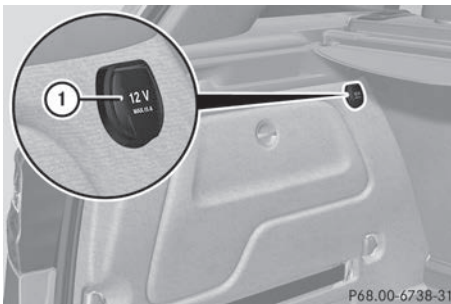

- ▶ Lift up the cover of socket ①.

mbrace

Important safety notes

- ! A license agreement must exist in order to activate the mbrace service. Ensure that your system is activated and ready for use, and press the  MB Info call button to register. If any of the steps mentioned is not carried out, the system may not be activated.

If you have questions about the activation, contact one of the following telephone assistance services:

- **USA:** Mercedes-Benz Customer Assistance Center under 1-800-FOR-MERCEdes (1-800-367-6372) or 1-888-990-9007
- **Canada:** Customer Service at 1-888-923-8367



Shortly after successfully registering with the mbrace service (Canada: TELEAID), a user ID and password will be sent to you by post. USA only: you can use this password to log onto the mbrace area under "Owners Online" at <http://www.mbusa.com>.

The mbrace system is available if:

- it has been activated and is operational
- the corresponding mobile phone network is available for transmitting data to the Customer Center
- a service subscription is available
- the starter battery is sufficiently charged
- ! Determining the location of the vehicle on a map is only possible if:
 - GPS reception is available.
 - the vehicle position can be forwarded to the Customer Assistance Center

The mbrace system

To adjust the volume during an mbrace call, proceed as follows:

- ▶ Press the  or  button on the multifunction steering wheel.
- or
- ▶ Use the volume controller of the audio system/COMAND.

The mbrace system provides various services, e.g.:





- automatic and manual emergency call
- Roadside Assistance call
- MB Info call

USA only: you can find information and a description of all available features under "Owners Online" at <http://www.mbusa.com>.

System self-test

After you have switched on the ignition, the system carries out a self-diagnosis.

A malfunction in the system has been detected if one of the following occurs:

- The indicator lamp in the SOS button does not come on during the system self-test.
- The indicator lamp in the  Roadside Assistance button does not light up during self-diagnosis of the system.
- The indicator lamp in the  MB Info call button does not light up during self-diagnosis of the system.
- The indicator lamp in one or more of the following buttons continues to light up red after the system self-diagnosis:
 - the SOS button
 - the  Roadside Assistance call button
 - the  MB Info call button
- the **mbrace Inoperative** or **mbrace Service Not Activated** message appears in the multifunction display after the system self-diagnosis.

If a malfunction is indicated as outlined above, the system may not operate as expected. In the event of an emergency, assistance must be summoned by other means.

Have the system checked at the nearest authorized Mercedes-Benz Center or contact the following service hotlines:

- **USA:** Mercedes-Benz Customer Assistance Center at 1-800-FOR-MERCEdes (1-800-367-6372) or 1-888-990-9007
- **Canada:** Customer Service at 1-888-923-8367

Emergency call

Important safety notes

WARNING

If the indicator lamp in the SOS button is flashing continuously and no voice connection with the Response center has been established, then the mbrace system has not been able to initiate an emergency call (e.g. the relevant mobile phone network is not available).

The **Call Failed** message is displayed in the multifunction display and must be confirmed.

Should this occur, assistance must be summoned by other means.

- A license agreement must exist in order to activate the mbrace service. Ensure that your system is activated and ready for use, and press the  MB Info call button to register. If any of the steps mentioned is not carried out, the system may not be activated.

If you have questions about the activation, contact one of the following telephone assistance services:

- **USA:** Mercedes-Benz Customer Assistance Center under 1-800-FOR-MERCEdes (1-800-367-6372) or 1-888-990-9007
- **Canada:** Customer Service at 1-888-923-8367

An emergency call is dialed automatically if an air bag or Emergency Tensioning Device is triggered.

- ⓘ You cannot end an automatically triggered emergency call yourself.

An emergency call can also be initiated manually.

As soon as the emergency call has been initiated, the indicator lamp in the SOS button flashes. The **Connecting Call** message appears on the multifunction display.

The audio output is muted.

Once the connection has been made, the **Call Connected** message appears in the multifunction display.

All important information on the emergency call is transmitted, for example:

- Current location of the vehicle (as determined by the GPS system)
- Vehicle identification number
- Information on the severity of the accident

Shortly after the emergency call has been initiated, a voice connection is automatically established between the Mercedes-Benz Customer Assistance Center and the vehicle occupants. If the vehicle occupants respond, the Mercedes-Benz Customer Assistance Center attempts to get more information on the emergency.

- i** If there is no response from the vehicle occupants, an ambulance is immediately sent to the vehicle.

Making an emergency call

⚠ WARNING

If you feel at any way in jeopardy when in the vehicle (e.g. smoke or fire in the vehicle, vehicle in a dangerous road location), please do not wait for voice contact after you have pressed the SOS button. Carefully leave the vehicle and move to a safe location. The Response Center will automatically contact local emergency officials with the vehicle's approximate location if they receive an automatic SOS signal and cannot make voice contact with the vehicle occupants.

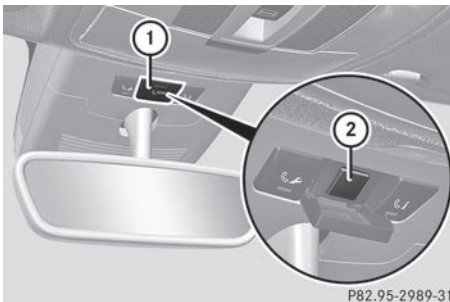

- ▶ **To initiate an emergency call manually:** press cover ① briefly to open.
- ▶ Press SOS button ② briefly. The indicator lamp in SOS button ② flashes until the emergency call is concluded.
- ▶ Wait for a voice connection to the Mercedes-Benz Customer Assistance Center.
- ▶ After the emergency call, close cover ①.

Roadside Assistance button

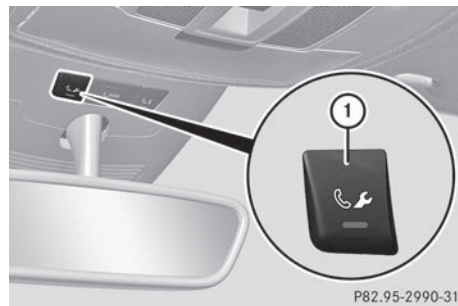

- ▶ Press Roadside Assistance button ①. This initiates a call to the Mercedes-Benz Customer Assistance Center. The indicator lamp in Roadside Assistance button ① flashes while the call is active. The **Connecting Call** message appears on the multifunction display. The audio output is muted.

If a connection can be made, the **Call Connected** message appears in the multifunction display.

If a cellular phone network is available and there is sufficient GPS reception, the mbrace system transmits data to the Mercedes-Benz Customer Assistance Center, for example:

- current location of the vehicle
- vehicle identification number
- i** The display of the audio system or COMAND shows that an mbrace call is active. During the call, you can change to

the navigation menu by pressing the NAVI button on COMAND, for example.

Voice output is not available.

A voice connection is established between the Mercedes-Benz Customer Assistance Center and the vehicle occupants.

From the vehicle remote malfunction diagnosis, the Mercedes-Benz Customer Assistance center can ascertain the nature of the problem (▷ page 251).

The Mercedes-Benz Customer Assistance Center either sends a qualified Mercedes-Benz technician or organizes for your vehicle to be transported to the nearest authorized Mercedes-Benz Center. You may be charged for services such as repair work and/or towing. Further details are available in your mbrace manual.

i The mbrace system failed to initiate a Roadside Assistance call if:

- the indicator lamp for Roadside Assistance call button ① is flashing continuously.
- no voice connection to the Mercedes-Benz Customer Assistance Center was established.

This may be because the corresponding mobile phone network is not available.

The **Call Failed** message appears in the multifunction display.

▶ **To end a call:** press the  button on the multifunction steering wheel.

or

▶ Press the corresponding button for ending a phone call on the audio system or on COMAND.

MB Info call button

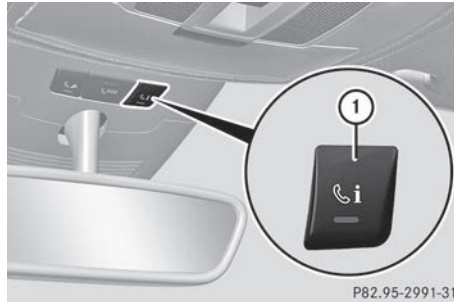

▶ Press MB Info call button ①.

This initiates a call to the Mercedes-Benz Customer Assistance Center. The indicator lamp in MB Info call button ① flashes while the connection is being made. The **Connecting Call** message appears on the multifunction display. The audio system is muted.

If a connection can be made, the **Call Connected** message appears in the multifunction display.

If a cellular phone network is available and there is sufficient GPS reception, the mbrace system transmits data to the Mercedes-Benz Customer Assistance Center, for example:

- current location of the vehicle
- vehicle identification number

i The display of the audio system or COMAND shows that an mbrace call is active. During the call, you can change to the navigation menu by pressing the NAVI button on COMAND, for example.

Voice output is not available.

A voice connection is established between the Mercedes-Benz Customer Assistance Center and the vehicle occupants. You can obtain information on how to operate your vehicle's systems, on the location of the nearest authorized Mercedes-Benz Center, and on further products and services offered by Mercedes-Benz USA.

USA only: you can find further information on the mbrace system under "Owners Online" at <http://www.mbusa.com>.

i The mbrace system failed to initiate an MB Info call if:

- the indicator lamp in MB Info call button  is flashing continuously.
- no voice connection to the Mercedes-Benz Customer Assistance Center was established.

This may be because the corresponding mobile phone network is not available.

The **Call Failed** message appears in the multifunction display.

▶ **To end a call:** press the  button on the multifunction steering wheel.

or

▶ Press the corresponding button for ending a phone call on the audio system or on COMAND.

Call priority

When service calls are active, e.g. Roadside Assistance or MB Info calls, an emergency call can still be initiated. In this case, an emergency call will take priority and override all other active calls.

The indicator lamp of the respective button flashes until the call is ended. An emergency call can only be terminated by the Mercedes-Benz Customer Assistance Center.

All other calls can be ended by pressing:

- the  button on the multifunction steering wheel
 - the corresponding button on the audio system or on COMAND for ending a telephone call
- i** If an mbrace call is initiated, audio output is muted. The mobile phone is no longer connected to COMAND. However, if you want to use your mobile phone, do so only when the vehicle is stationary and in a safe location.

Downloading destinations in COMAND

Downloading destinations

Destination Download gives you access to a data bank with over 15 million Points of Interest (POIs). These can be downloaded on the navigation system in your vehicle. If you know the destination, the address can be downloaded. Alternatively, you can obtain the location of Points of Interest (POIs)/ important destinations in the vicinity.

Furthermore, you can download routes with up to 20 way points.

You are prompted to confirm route guidance to the address entered.

The system calculates the route and subsequently starts the route guidance with the address entered.

i If you select **No**, the address can be stored in the address book.

i The Destination Download function is available if the corresponding mobile phone network is available and data transfer is possible.

i You can only use the Destination Download function if the vehicle is equipped with a navigation system.

Route Assistance

This service is part of the mbrace PLUS Package and cannot be purchased separately.

i You can also use the Route Assistance function if your vehicle is not equipped with a navigation system.

Within the framework of this service, you receive a professional and reliable form of navigation support without having to leave your vehicle.

The customer service representative finds a suitable route depending on your vehicle's current position and the desired destination. You will then be guided live through the current route section.

Search & Send

General notes

- i** To use "Search & Send", your vehicle must be equipped with mbrace and a navigation system. You must also have an mbrace service subscription.

"Search & Send" is a destination entry service. A destination address which is found on Google Maps® can be transferred via mbrace directly to your vehicle's navigation system.

Specifying and sending the destination address

- ▶ Go to the website <http://www.maps.google.com> and enter a destination address into the entry field.
- ▶ **To send the destination address to the e-mail address of your mbrace account:** click on the corresponding button.

- i** Example:

If you select 'Send to vehicle' and then 'Mercedes-Benz', the destination address will be sent to your vehicle.

- ▶ When the "Send" dialog window appears: In the relevant field, enter the e-mail address which you specified when activating your mbrace account.
- ▶ Click "Send".

- i** Information on specific commands such as "Address entry" or "Sending" can be found on the website.

Calling up destination addresses

- ▶ Switch on the ignition. The destination address is loaded into the vehicle's navigation system.

A display message appears, asking whether navigation should be started.

- ▶ Select **Yes** by sliding $\leftarrow \odot \rightarrow$ and turning $\left\{ \odot \right\}$ the COMAND controller and press \odot to confirm.

The system calculates the route and subsequently starts the route guidance with the address entered.

- i** If you select **No**, the address can be stored in the address book.
- i** If you have sent more than one destination address, each individual destination must be confirmed separately.

- i** Destination addresses are loaded in the same order as the order in which they were sent. If you have multiple Mercedes-Benz vehicles with mbrace and active mbrace accounts:

if multiple vehicles are registered under the same e-mail address, the destination will be sent to all the vehicles.

Vehicle remote opening

You can use the vehicle remote opening if you have unintentionally locked your vehicle and a replacement SmartKey is not available. The vehicle can be opened by the Mercedes-Benz Customer Assistance Center.

The vehicle can be immediately opened remotely within four days of the ignition being turned off. After this time, the remote opening may be delayed by 15 to 60 minutes. After 30 days the vehicle can no longer be opened remotely.

- ▶ Contact the following service hotlines:
 - **USA:** Mercedes-Benz Customer Assistance Center at

1-800-FOR-MERCEdes
(1-800-367-6372) or 1-888-990-9007

- **Canada:** Customer Service at 1-888-923-8367

You will be asked for your password.

- ▶ Return to your vehicle at the time agreed upon with the Mercedes-Benz Customer Assistance Center.

USA only: alternatively, the vehicle can be opened via:

- the Internet, under the "Owners Online" section
- the telephone application (e.g. iPhone®, Blackberry)

To do this, you will need your identification number and password.

- ❗ Vehicle remote opening is only possible if the corresponding mobile phone network is accessible.

Vehicle remote closing

The remote closing feature can be used when you have forgotten to lock the vehicle and you are no longer nearby. The vehicle can then be locked by the Mercedes-Benz Customer Assistance Center.

The vehicle can be immediately remotely locked within four days of the ignition being turned off. After this time, the remote closing may be delayed by 15 to 60 minutes. After 30 days the vehicle can no longer be closed remotely.

- ▶ Contact the following service hotlines:
 - **USA:** Mercedes-Benz Customer Assistance Center at 1-800-FOR-MERCEdes (1-800-367-6372) or 1-888-990-9007
 - **Canada:** Customer Service at 1-888-923-8367
 You will be asked for your PIN.

The next time you are inside the vehicle and you switch on the ignition, the **Doors Locked Remotely** message appears in the multifunction display.

USA only: alternatively, the vehicle can be locked via:

- the Internet, under the "Owners Online" section
- the telephone application (e.g. iPhone®, Blackberry)

To do this, you will need your identification number and password.

- ❗ The vehicle remote closing feature is available when the relevant mobile phone network is available and data connection is possible.

Stolen vehicle recovery service

If your vehicle has been stolen:

- ▶ Notify the police.
The police will issue a numbered incident report.
- ▶ This number will be forwarded to the Mercedes-Benz Customer Assistance Center together with your PIN.
The Mercedes-Benz Customer Assistance Center then attempts to locate the mbrace system. The Mercedes-Benz Customer Assistance Center contacts you and the local law enforcement agency if the vehicle is located. However, only the law enforcement agency is informed of the location of the vehicle.

- ❗ If the anti-theft alarm system is activated for longer than 30 seconds, the Mercedes-Benz Customer Assistance center is automatically informed.

Vehicle remote malfunction diagnosis

With the vehicle remote malfunction diagnosis (Vehicle Health Check), the Customer Assistance center can provide improved support for problems with your vehicle. During an existing call, vehicle data is transferred to the Customer Assistance center. The customer service representative can use the received data to decide what kind of assistance is required. You are then, for

example, guided to the nearest Mercedes-Benz Service center or a recovery vehicle is called.

If vehicle data needs to be transferred during an MB Info call or a Roadside Assistance call, this is initiated by the Customer Assistance center. You will see the **Roadside Assistance Connected** message in the COMAND display. If the vehicle remote malfunction diagnosis is able to be started, the **Request for vehicle diagnosis received. Start vehicle diagnosis?** message appears in the display.

- ▶ Press **Yes** to confirm the message.
- ▶ If the **Vehicle Diagnosis: Please switch on ignition.** message appears: turn the key to position **2** in the ignition lock.
- ▶ If the **Please follow the instructions received by phone and move your vehicle to a safe position.** message appears: follow the instructions of the customer service representative. The message in the display disappears. If you select **Cancel**, the vehicle remote malfunction diagnosis is canceled completely. The vehicle operating state check begins. Meanwhile, the **Vehicle diagnosis activated** message appears.

When the check is finished, the **Sending vehicle diagnosis data...(Voice connection may be interrupted during data transfer.)** message appears. The vehicle data can now be sent to the Customer Assistance center.

- ▶ Press **OK** to confirm the message. The voice connection with the Customer Assistance center is terminated. The **Vehicle Diagnosis: Transferring data...** appears. The vehicle data is sent to the Customer Assistance center.

Depending on what the customer service representative agreed with you, the voice connection is re-established after the transfer is complete. If necessary, you will be contacted at a later time by another means, e.g. by E-Mail or telephone.

Further functions of the vehicle remote malfunction diagnosis include, for example:

- transfer of service data to the Customer Assistance center. If a service is overdue, the COMAND display shows a message about various special offers at your workshop.
- monthly status information E-Mail on oil level, air pressure, maintenance, brakes, etc. If applicable, you will receive information on special offers in the E-Mail. USA only: this information can also be called up under "Owners Online" at <http://www.mbusa.com>.

Information on the data stored in the vehicle (▷ page 24).

Information on roadside assistance (▷ page 21).

Downloading routes

Downloading routes allows you to transfer and save predefined routes in the navigation system. To do this, an SD memory card must be inserted into the COMAND system. If no SD memory card is inserted, you must insert the card into the card slot on the COMAND system before saving.

A route can be prepared and sent either by a customer service representative or via the mbrace portal on the Internet. Each route can include up to 20 way points. When a route has been received by the navigation system, **'Route name' has been saved to memory card. Do you want to start route guidance?** appears on the COMAND display. The route is saved to the SD memory card.

- ▶ **To start route guidance:** select **Yes**.
An overview of the route is shown in the display.
- ▶ **i** If you select **No**, the saved route can be called up later in the navigation menu.
- ▶ Select **Start**.
Route guidance is started.
- ▶ **i** Downloaded and saved data can be called up again in COMAND. Further information can be found in the "COMAND", "Online and Internet services" and "Download destination/route" sections.

Speed alert

You can define the upper speed limit, which must not be exceeded by the vehicle. If this selected speed is exceeded by the vehicle, a message will be sent to the Customer Assistance center. The Customer Assistance center then forwards this information to you. You can select the way in which you receive this information beforehand. Possible options include SMS, E-Mail or an automated call.

The data which is sent to the Customer Assistance center contains the following information:

- the location where the speed limit was exceeded
- the time at which the speed limit was exceeded
- the selected speed limit which was exceeded

Geo fencing

Geo fencing allows you to select areas which the vehicle should not enter or leave. You will be informed if the vehicle crosses the boundaries of the selected areas. You can select the way in which you receive this information beforehand. Possible options include SMS, E-Mail or an automated call.

The area can be determined as either a circle or a polygon with a maximum of ten corners. You can specify up to ten areas

simultaneously. Different settings are possible for each area.

USA only: these settings can be called up under "Owners Online" at <http://www.mbusa.com>.

Alternatively, you can trigger an MB Info call and inform the customer service representative that you wish to activate geo fencing.

Currently inactive areas can be activated by SMS.

Triggering the vehicle alarm

With this function, you can trigger the vehicle's panic alarm via SMS. An alarm sounds and the exterior lighting flashes. Depending on the setting, the panic alarm lasts five or ten seconds. Afterwards, the alarm switches off.

Garage door opener

Important safety notes

WARNING

Before programming the integrated remote control to a garage door opener or gate operator, make sure people and objects are out of the way of the device to prevent potential harm or damage. When programming a garage door opener, the door moves up or down. When programming a gate operator, the gate opens or closes.

Do not use the integrated remote control with any garage door opener that lacks safety stop and reverse features as required by U.S. federal safety standards (this includes any garage door opener model manufactured before April 1, 1982). A garage door that cannot detect an object - signaling the door to stop and reverse - does not meet current U.S. federal safety standards.

When programming a garage door opener, park vehicle outside the garage.

Do not run the engine while programming the integrated remote control. Inhalation of exhaust gas is hazardous to your health. All exhaust gas contains carbon monoxide (CO), and inhaling it can cause unconsciousness and possible death. All exhaust gas contains carbon monoxide (CO), and inhaling it can cause unconsciousness and possible death.

The HomeLink® garage door opener integrated in the rear-view mirror allows you to operate up to three different door and gate systems.

i Certain garage door drives are incompatible with the integrated garage door opener. If you have difficulty programming the integrated garage door opener, contact an authorized Mercedes-Benz Center.

Alternatively, you can call the following telephone assistance services:

- **USA:** Mercedes-Benz Customer Assistance Center at 1-800-FOR-MERCEdes
- **Canada:** Customer Service at 1-800-387-0100
- HomeLink® hotline 1-800-355-3515 (free of charge)

More information on HomeLink® and/or compatible products is also available online at <http://www.homelink.com>.

i USA only:

This device complies with part 15 of the FCC Rules. Operation is subject to the following two conditions:

1. This device may not cause harmful interference, and
2. this device must accept any interference received, including interference that may cause undesired operation.

Any unauthorized modification to this device could void the user's authority to operate the equipment.

FCC ID: CB2HMIHL4

i Canada only:

This device complies with the RSS-210 Rules of Industry Canada. Operation is subject to the following two conditions:

1. This device may not cause harmful interference, and
2. this device must accept any interference received, including interference that may cause undesired operation of the device.

Any unauthorized modification to this device could void the user's authority to operate the equipment.

IC: 279B-HMIHL4

Programming

Programming buttons

⚠ WARNING

Only press the button on the integrated garage door opener if there are no persons or objects present within the sweep of the garage door. Persons could otherwise be injured as the door moves.

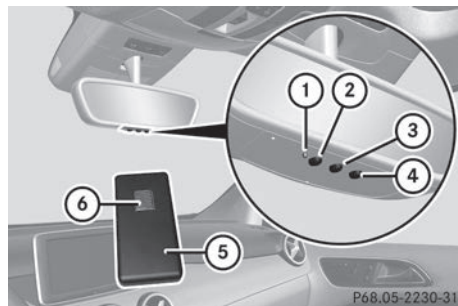

Integrated garage door opener on the rear-view mirror

Garage door remote control **⑤** is not part of the integrated garage door opener.

- ▶ Before programming for the first time, clear the memory of the integrated garage door opener (▷ page 256).
- ▶ Turn the SmartKey to position **2** in the ignition lock.

- ▶ Press and hold one of buttons ② to ④ on the integrated garage door opener. After a short time, indicator lamp ① lights up yellow.
 - ❗ Indicator lamp ① lights up yellow as soon as button ②, ③ or ④ is programmed for the first time. If the selected button has already been programmed, indicator lamp ① will only light up yellow after ten seconds have elapsed.
- ▶ Release button ②, ③ or ④. Indicator lamp ① flashes yellow.
- ▶ Point garage door remote control ⑤ towards buttons ② to ④ on the rear-view mirror at a distance of 2 to 8 inches (5 to 20 cm).
 - ❗ The required distance between remote control ⑤ and the integrated garage door opener depends on the garage door drive system. Several attempts might be necessary. You should test every position for at least 25 seconds before trying another position.
- ▶ Press and hold button ⑥ on remote control ⑤ until indicator lamp ① lights up green. If indicator lamp ① lights up green or flashes, then programming has been successful.
- ▶ Release button ⑥ on remote control ⑤ for the garage door drive system.
- ▶ If indicator lamp ① lights up red: repeat the programming procedure for the corresponding button on the rear-view mirror. When doing so, vary the distance between remote control ⑤ and the rear-view mirror.
 - ❗ If the indicator lamp flashes green after successful programming, the garage door system is using a rolling code. After programming, you must synchronize the garage door opener integrated in the rear-view mirror with the receiver of the garage door system.

Synchronizing the rolling code

Your vehicle must be within reach of the garage door or exterior gate drive. Make sure that neither your vehicle nor any persons/objects are present within the sweep of the door or gate.

Observe the safety notes when performing the rolling code synchronization (▶ page 253).

Observe the safety notes when performing the rolling code synchronization.

- ▶ Turn the SmartKey to position 2 in the ignition lock.
- ▶ Press the programming button of the door or gate drive (see the door or gate drive operating instructions, e.g. under "Programming of additional remote controls").
 - ❗ Usually, you now have 30seconds to initiate the next step.

- ▶ Press previously programmed button ②, ③ or ④ of the integrated garage door opener until the door closes. The rolling code synchronization is then complete.

Notes on programming the remote control

Canadian radio frequency laws require a "break" (or interruption) of the transmission signals after broadcasting for a few seconds. Therefore, these signals may not last long enough for the integrated garage door opener. The signal is not recognized during programming. Comparable with Canadian law, some U.S. garage door openers are designed to "time-out" in the same manner. Proceed as follows:

- if you live in Canada
- if you have difficulties programming the garage door opener (regardless of where you live) when using the programming steps

- ▶ Press and hold one of buttons ② to ④ on the integrated garage door opener. After a short time, indicator lamp ① lights up yellow.
- ▶ Release the button. Indicator lamp ① flashes yellow.
- ▶ Press button ⑥ of garage door remote control ⑤ for two seconds, then release it for two seconds.
- ▶ Press button ⑥ again for two seconds.
- ▶ Repeat this sequence on button ⑥ of remote control ⑤ until indicator lamp ① lights up green. If indicator lamp ① turns red, repeat the process.
- ▶ Continue with the other programming steps (see above).

Problems when programming

If you are experiencing problems programming the integrated garage door opener on the rear-view mirror, take note of the following instructions:

- Check the transmitter frequency of garage door drive remote control ⑤. This can usually be found on the back of the remote control. The integrated garage door opener is compatible with devices that have units which operate in the frequency range of 280 to 433 MHz.
- Replace the batteries in garage door remote control ⑤. This increases the likelihood that garage door remote control ⑤ will transmit a strong and precise signal to the integrated garage door opener in the rear-view mirror.
- When programming, hold remote control ⑤ at varying distances and angles from the button that you are programming. Try various angles at a distance between 2 and 12 inches (5 to 30 cm) or at the same angle but at varying distances.
- If another remote control for the same garage door drive is available, repeat the

same programming steps with this remote control. Before performing these steps, make sure that new batteries have been installed in garage door drive remote control ⑤.

- Note that some remote controls only transmit for a limited amount of time (the indicator lamp on the remote control goes out). Press button ⑥ on remote control ⑤ again before transmission ends.
- Align the antenna cable of the garage door opener unit. This can improve signal reception/transmission.

Opening/closing the garage door

After it has been programmed, the integrated garage door opener performs the function of the garage door system remote control. Please also read the operating instructions for the garage door system.

- ▶ Turn the SmartKey to position **2** in the ignition lock.
 - ▶ Press button ②, ③ or ④ which you have programmed to operate the garage door. Garage door system with a fixed code: indicator lamp ① lights up green. Garage door system with a rolling code: indicator lamp ① flashes green.
- i** The transmitter will transmit a signal as long as the button is pressed. The transmission is halted after a maximum of ten seconds and indicator lamp ① lights up yellow. Press button ②, ③ or ④ again if necessary.

Clearing the memory

- ▶ Turn the SmartKey to position **2** in the ignition lock.
- ▶ Press buttons ② and ④. The indicator lamp lights up yellow.
- ▶ Press and hold buttons ② and ④ until the indicator lamp turns green.

- i** Make sure that you clear the memory of the integrated garage door opener before selling the vehicle.

Compass

Calling up the compass

The compass shows which direction the vehicle is currently traveling in: **N, NE, E, SE, S, SW, W** or **NW**.

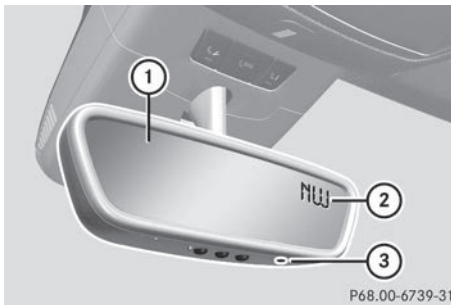

P68.00-6739-31

To obtain a correct display in rear-view mirror ①, the compass must be calibrated and the magnetic field zone must be set.

Setting the compass

- Determine your position using the following zone maps.

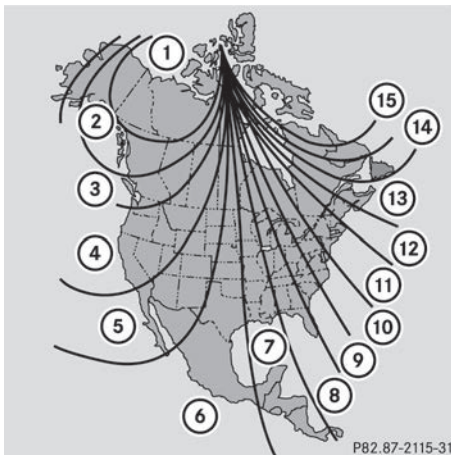

P82.87-2115-31

North America zone map

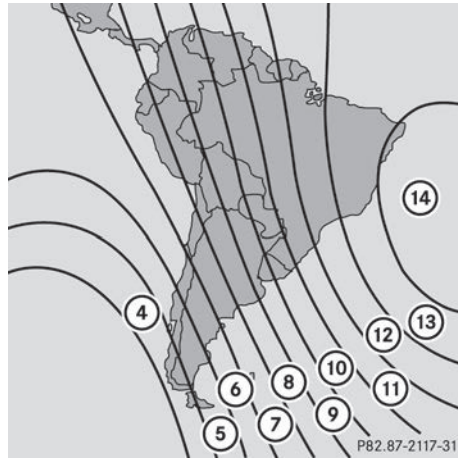

P82.87-2117-31

South America zone map

- Press a round pin into opening ③ (▷ page 257) for approximately three seconds.

The currently selected zone appears in compass display ② (▷ page 257).

- **To select the zone:** press a round pin into opening ③ (▷ page 257) repeatedly until the desired zone is selected.

The zone has been selected when compass display ② (▷ page 257) shows the heading.

This takes a few seconds.

Calibrating the compass

- Make sure that there is sufficient space for you to drive in a circle without impeding the remaining traffic.

In order to calibrate the compass correctly, observe the following points:

- calibrate the compass in the open and not in the vicinity of steel constructions or high-voltage transmission lines.
- switch off electrical consumers such as the climate control, windshield wipers or rear window defroster.
- close all doors and the tailgate.
- Switch the ignition on.
- Press a round pin into opening ③ (▷ page 257) for approximately six

seconds until the **C** symbol appears in compass display ② (▷ page 257).

- ▶ Drive a full circle at approximately 3 mph (5 km/h) to 6 mph (10 km/h). Once the calibration has been successfully completed, the current direction appears in compass display ② (▷ page 257).

Floor mat on the driver's side

WARNING

Whenever you are using a floor mat, make sure there is enough clearance and that the floor mat is securely fastened.

The floor mat should always be securely fastened using the fastening equipment.

Before driving off, check that the floor mat is securely in place and adjust it if necessary. A loose floor mat could slip and hinder proper functioning of the pedals.

Do not place several floor mats on top of each other as this may impair pedal movement.

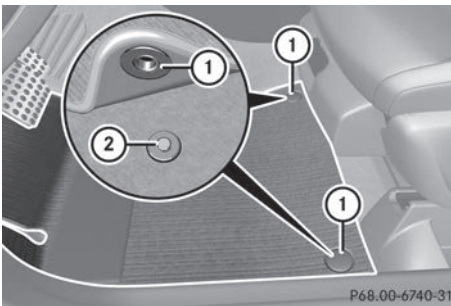

- ▶ Slide the seat backwards.
- ▶ **To install:** place the floor mat in the footwell.
- ▶ Press safety catch knobs ① onto retainers ②.
- ▶ **To remove:** pull the floor mat off retainers ②.
- ▶ Remove the floor mat.

Useful information	260
Engine compartment	260
Maintenance	264
Care	265

Useful information

- i** This Operator's Manual describes all models and all standard and optional equipment of your vehicle available at the time of publication of the Operator's Manual. Country-specific differences are possible. Please note that your vehicle may not be equipped with all features described. This also applies to safety-related systems and functions.
- i** Please read the information on qualified specialist workshops (▷ page 23).

Engine compartment

Hood

Opening the hood

⚠ WARNING

Do not pull the release lever while the vehicle is in motion. Otherwise, the hood could be forced open by passing air flow.

This could cause the hood to come loose and injure you and/or others.

⚠ WARNING

Do not open the hood when the engine is overheated. You could be seriously injured. Observe the coolant temperature gauge to determine whether the engine may be overheated. If you see flames or smoke coming from the engine compartment, move away from the vehicle. Wait until the engine has cooled. If necessary, call the fire department.

⚠ WARNING

There is a risk of injury if the hood is open, even if the engine is not running.

Some engine components can become very hot.

To avoid the risk of burns, only touch those components described in the Operator's Manual and observe the relevant safety notes.

⚠ WARNING

To avoid injury, stay clear of moving parts when the hood is open and the engine is running.

The radiator fan may continue to run for approximately 30 seconds or may even restart after the engine has been switched off. For this reason, you must not reach into the fan rotation area.

⚠ WARNING

The engine is equipped with a transistorized ignition system. Because of the high voltage, it is dangerous to touch any components (ignition coils, spark plug sockets, diagnostic socket) of the ignition system:

- with the engine running
- while starting the engine
- when the ignition is switched on and the engine is turned manually

⚠ WARNING

The windshield wipers and wiper linkage could be set in motion.

When the hood is open, you or others could be injured by the wiper linkage.

Make sure that the windshield wipers are switched off and that the key has been pulled out of the ignition lock before opening the hood.

- !** Make sure that the windshield wipers are not folded away from the windshield. You could otherwise damage the windshield wipers or the hood.



- ▶ Make sure that the windshield wipers are switched off.
- ▶ Pull release lever ① on the hood. The hood is released.



- ▶ Reach into the gap between the hood and the radiator grill and press hood catch lever ② to the left.
- ▶ Raise the hood.

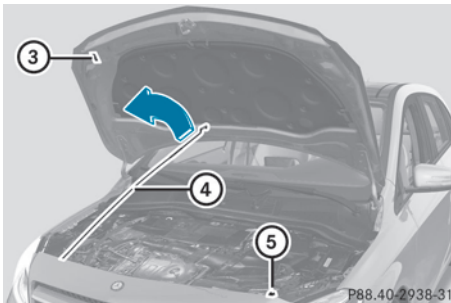

- ▶ Pull support strut ④ out of bracket ⑤.
- ▶ Lift up support strut ④ and insert it into yellow retaining clip ③.

Closing the hood

⚠ WARNING

When closing the hood, use extreme caution not to catch hands or fingers. Be careful that you do not close the hood on anyone. Make sure the hood is securely engaged before driving off. Do not continue driving if the hood can no longer engage after an accident, for example. The hood could

otherwise come loose while the vehicle is in motion and injure you and/or others.

- ▶ Raise the hood slightly and, at the same time, remove support strut ④ from yellow retaining clip ③.
- ▶ Swing support strut ④ down and press it into bracket ⑤ until it engages.
- ▶ Lower the hood and let it fall from a height of approximately 8 inches (20 cm).
- ▶ Check that the hood has engaged properly. If the hood can be raised slightly, it is not properly engaged. Do not press the hood closed. Open the hood again and close it with a little more force.

Engine oil

General notes

Depending on the driving style, the vehicle consumes up to 0.9 US qt (0.8 liters) of oil over a distance of 600 miles (1,000 km). The oil consumption may be higher than this when the vehicle is new or if you frequently drive at high engine speeds.

Depending on the engine, the oil dipstick may be in a different location.

When checking the oil level:

- park the vehicle on a level surface.
- the engine should be switched off for approximately five minutes if the engine is at normal operating temperature.
- if the engine is not at normal operating temperature, e.g. if the engine was only started briefly: wait about 30 minutes before carrying out the measurement.

Checking the oil level using the oil dipstick

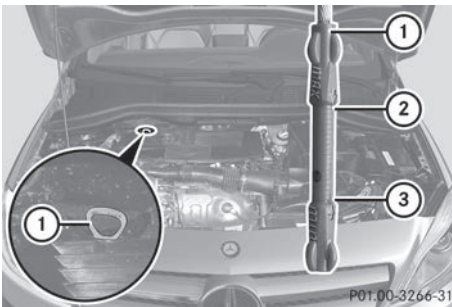

- ▶ Pull oil dipstick ① out of the dipstick guide tube.
- ▶ Wipe off oil dipstick ①.
- ▶ Slowly slide oil dipstick ① into the guide tube to the stop, and take it out again. If the level is between MIN mark ③ and MAX mark ②, the oil level is correct.
- ▶ If the oil level has dropped to MIN mark ③ or below, add 1.1 US qt (1.0 liter) of engine oil.

Adding engine oil

WARNING

If engine oil comes into contact with hot engine parts, it may ignite and you could burn yourself. Do not spill any engine oil on hot engine parts.

Environmental note

When adding oil, take care not to spill any. If oil enters the soil or waterways, it is harmful to the environment.

- ❗ Only use engine oils and oil filters that have been approved for vehicles with a service system. You can obtain a list of the engine oils and oil filters tested and approved in accordance with the Mercedes-Benz Specifications for Service Products at any Mercedes-Benz Service center.

Damage to the engine or exhaust system is caused by the following:

- using engine oils and oil filters that have not been specifically approved for the service system
- replacing engine oil and oil filters after the interval for replacement specified by the service system has been exceeded
- using engine oil additives.

- ❗ Do not add too much oil. adding too much engine oil can result in damage to the engine or to the catalytic converter. Have excess engine oil siphoned off.

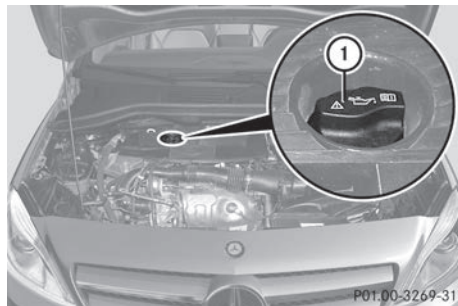

Example: engine oil cap

- ▶ Turn cap ① counter-clockwise and remove it.
- ▶ Add engine oil.
If the oil level is at or below the MIN mark on the oil dipstick, add 1.1 US qt (1.0 liter) of engine oil.
- ▶ Replace cap ① on the filler neck and turn clockwise.
Ensure that the cap locks into place securely.
- ▶ Check the oil level again with the oil dipstick (▷ page 262).

Further information on engine oil (▷ page 326).

Additional service products

Checking the coolant level

⚠ WARNING

In order to avoid potentially serious burns:

- use extreme caution when opening the hood if there are any signs of steam or coolant leaking from the cooling system, or if the coolant temperature display indicates that the coolant is overheated.
- do not remove the pressure cap on the coolant tank if the coolant temperature is above 104 °F (40 °C). Allow the engine to cool down before removing the cap. The coolant tank contains hot fluid and is under pressure.
- using a cloth, slowly turn the cap approximately 1/2 turn to relieve excess pressure. If you open the cap immediately, scalding hot fluid and steam will be blown out under pressure.
- do not spill antifreeze on hot engine parts. Antifreeze contains ethylene glycol which may burn if it comes into contact with hot engine parts.

! The coolant may only be checked and corrected when the engine is cool (coolant temperature below 104 °F (40 °C). Checking the coolant when the coolant temperature is above 104 °F (40 °C) may result in damage to the engine or to the engine cooling system.

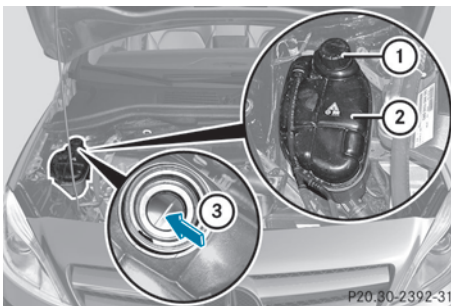

Example

- ▶ Park the vehicle on a level surface.

Only check the coolant level when the vehicle is on a level surface and the engine has cooled down.

- ▶ Turn the SmartKey to position **2** in the ignition lock (▷ page 127).
- ▶ Check the coolant temperature display in the instrument cluster. The coolant temperature must be below 104 °F (40 °C).
- ▶ Turn the SmartKey to position **0** (▷ page 127) in the ignition lock.
- ▶ Slowly turn cap ① half a turn counter-clockwise to allow excess pressure to escape.
- ▶ Turn cap ① further counter-clockwise and remove it. If the coolant is at the level of marker bar ③ in the filler neck when cold, there is enough coolant in coolant expansion tank ②.
- ▶ If necessary, add coolant that has been tested and approved by Mercedes-Benz.
- ▶ Replace cap ① and turn it clockwise as far as it will go.

For further information on coolant, see (▷ page 327).

Adding washer fluid to the windshield washer system/headlamp cleaning system

⚠ WARNING

Washer solvent/antifreeze is highly flammable. Do not spill washer solvent/antifreeze on hot engine parts, because it may ignite and burn. You could be seriously burned.

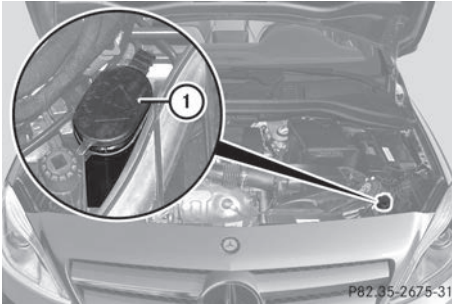

Example

- ▶ **To open:** pull cap ① upwards by the tab.
- ▶ Add the premixed washer fluid.
- ▶ **To close:** press cap ① onto the filler neck until it engages.

The washer fluid reservoir is used for both the windshield washer system and the headlamp cleaning system.

Further information on windshield washer fluid/antifreeze (▷ page 328).

Maintenance

ASSYST PLUS

Service messages

The ASSYST PLUS service interval display informs you of the next service due date.

The multifunction display shows a service message for several seconds, e.g.:

Next Service A Due in .. Days

Service A Due

Service A Exceeded by .. Days

The letter **A** or **B**, possibly in connection with a number or another letter, shows the type of service. **A** stands for a minor service and **B** for a major service.

You can obtain further information from any authorized Mercedes-Benz Center.

Information on the type of service and service intervals (see the separate Maintenance Booklet).

The ASSYST PLUS service interval display does not take into account any periods of time during which the battery is disconnected.

Maintaining the time-dependent service schedule:

- ▶ Note down the service due date displayed in the multifunction display before disconnecting the battery.

or





- ▶ After reconnecting the battery, subtract the battery disconnection periods from the service date shown on the display.

i The ASSYST PLUS service interval display does not show any information on the engine oil level. Observe the notes on the engine oil level (▷ page 261).

Hiding a service message

- ▶ Press  or **OK**.

Displaying service messages

- ▶ Switch on the ignition.
- ▶ Using  or , select the **Serv.** menu.
- ▶ Press  or  to select the **ASSYST PLUS** submenu and press **OK** to confirm. The service due date appears in the multifunction display.

Information about Service

Resetting the ASSYST PLUS service interval display

i If the ASSYST PLUS service interval display has been inadvertently reset, this setting can be corrected at a qualified specialist workshop.

Have service work carried out as described in the Maintenance Booklet. This may otherwise lead to increased wear and damage to the major assemblies or the vehicle.

A qualified specialist workshop, e.g. an authorized Mercedes-Benz Center, will reset the ASSYST PLUS service interval display after the service work has been carried out. You can obtain further information, e.g. regarding service work, from an authorized Mercedes-Benz Center or directly from Mercedes-Benz.

Special service requirements

Arduous operating conditions or increased loads on the vehicle will require some service work to be performed more often than for a vehicle in normal use. Such arduous conditions include regular city driving with frequent intermediate stops and use in mountainous terrain or on poor road surfaces.

For example, if the vehicle is used under arduous operating conditions, have air filters, engine oil and oil filters changed frequently and check the wheels often. Further information can be obtained at a qualified specialist workshop, e.g. an authorized Mercedes-Benz Center.

Driving abroad

An extensive Mercedes-Benz Service network is also available in other countries. You can obtain further information from any authorized Mercedes-Benz Center.

Care

General notes

WARNING

Many cleaning products can be hazardous. Some are poisonous, others are flammable. Always follow the instructions on the particular container. Always open your vehicle's doors or windows when cleaning the inside.

Never use fluids or solvents that are not designed for cleaning your vehicle.

Always lock away cleaning products and keep them out of reach of children.

Environmental note

Dispose of empty packaging and cleaning cloths in an environmentally responsible manner.

 For cleaning your vehicle, do not use any of the following:

- dry, rough or hard cloths
- abrasive cleaning agents
- solvents
- cleaning agents containing solvents

Do not scrub.

Do not touch the surfaces or protective films with hard objects, e.g. a ring or ice scraper. You could otherwise scratch or damage the surfaces and protective film.

 Do not park the vehicle for an extended period straight after cleaning it, particularly after having cleaned the wheels with wheel cleaner. Wheel cleaners could cause increased corrosion of the brake discs and brake pads/linings. For this reason, you should drive for a few minutes after cleaning. Braking heats the brake discs and the brake pads/linings, thus drying them. The vehicle can then be parked.

Regular care of your vehicle is a condition for retaining the quality in the long term.

Use care products and cleaning agents recommended and approved by Mercedes-Benz.

Exterior care

Automatic car wash

WARNING

Braking efficiency is reduced after washing the vehicle. This could cause an accident. For this reason, you must drive particularly carefully after washing the vehicle until the brakes have dried.

⚠ WARNING

The vehicle is braked when the HOLD function or DISTRONIC PLUS is activated. Therefore, deactivate the HOLD function and DISTRONIC PLUS before the vehicle is washed in an automatic car wash.

! Never clean your vehicle in a Touchless Automatic Car Wash as these use special cleaning agents. These cleaning agents can damage the paintwork or plastic parts.

! Make sure that the automatic transmission is in position **N** when washing your vehicle in a tow-through car wash. The vehicle could be damaged if the transmission is in another position.

! Make sure that:

- the side windows and the sliding sunroof are fully closed.
- the ventilation/heating is switched off (the OFF button has been pressed/the airflow control is set to position **0**).
- the windshield wiper switch is in position **0**.

Otherwise, the vehicle might be damaged.

You can wash the vehicle in an automatic car wash from the very start.

If the vehicle is very dirty, pre-wash it before cleaning it in an automatic car wash.

After using an automatic car wash, wipe off wax from the windshield and the wiper blades. This will prevent smears and reduce wiping noises caused by residue on the windshield.

Washing by hand

In some countries, washing by hand is only allowed at wash bays that are specially designed for this purpose. Observe the legal requirements in all countries concerned.

- ▶ Do not use hot water and do not wash the vehicle in direct sunlight.
- ▶ Use a soft sponge to clean.

- ▶ Use a mild cleaning agent, such as a car shampoo approved by Mercedes-Benz.
- ▶ Thoroughly hose down the vehicle with a gentle jet of water.
- ▶ Do not point the water jet directly towards the air inlet.
- ▶ Use plenty of water and rinse out the sponge frequently.
- ▶ Rinse the vehicle with clean water and dry thoroughly with a chamois.
- ▶ Do not let the cleaning agent dry on the paintwork.

When using the vehicle in winter, remove all traces of road salt deposits carefully and as soon as possible.

Power washers**⚠ WARNING**

Do not use power washers with circular-jet nozzles (dirt grinders) to clean your vehicle, in particular the tires. You could otherwise damage the tires and cause an accident.

! Always maintain a distance of at least 11.8 in (30 cm) between the vehicle and the power washer nozzle. Information about the correct distance is available from the equipment manufacturer.

Move the power washer nozzle around when cleaning your vehicle.

Do not aim directly at any of the following:

- tires
- door gaps, roof gaps, joints, etc.
- electrical components
- battery
- connectors
- lights
- seals
- trim
- ventilation slots

Damaged seals or electrical components can lead to leaks or failures.

Cleaning the wheels

! Do not use acidic wheel cleaning products to remove brake dust. This could damage wheel bolts and brake components.

! Do not park the vehicle for an extended period straight after cleaning it, particularly after having cleaned the wheels with wheel cleaner. Wheel cleaners could cause increased corrosion of the brake discs and brake pads/linings. For this reason, you should drive for a few minutes after cleaning. Braking heats the brake discs and the brake pads/linings, thus drying them. The vehicle can then be parked.

Cleaning the paintwork

! Do not affix:

- stickers
 - films
 - magnetic plates or similar items
- to painted surfaces. You could otherwise damage the paintwork.

- ▶ Remove dirt immediately, where possible, while avoiding rubbing too hard.
- ▶ Soak insect remains with insect remover and rinse off the treated areas afterwards.
- ▶ Soak bird droppings with water and rinse off the treated areas afterwards.
- ▶ Remove coolant, brake fluid, tree resin, oils, fuels and greases by rubbing gently with a cloth soaked in petroleum ether or lighter fluid.
- ▶ Use tar remover to remove tar stains.
- ▶ Use silicone remover to remove wax.
- ▶ Use a suitable touch-up stick, e.g. MB Touch-Up Stick, to repair slight damage to the paintwork quickly and provisionally.

The following cannot always be completely repaired:

- scratches
- corrosive deposits

- areas affected by corrosion
- damage caused by inadequate care

In such cases, visit a qualified specialist workshop.

If water no longer forms "beads" on the paint surface, use the paint care products recommended and approved by Mercedes-Benz. This is the case approximately every three to five months, depending on the climate conditions and the care product used. If the dirt has penetrated the paint surface or if the paintwork has become dull, then the paintwork should be cleaned. For cleaning, please use the paint cleaner recommend and approved by Mercedes Benz.

Do not use these care products in the sun or on the hood while the hood is hot.

Matte finish care

! Never polish the vehicle or the light alloy wheels. Polishing causes the finish to shine.

! The following may cause the paint to become shiny and thus reduce the matte effect:

- Vigorous rubbing with unsuitable materials.
- Frequent use of car washes.
- Washing the vehicle in direct sunlight.

! Never use paint cleaner, buffing or polishing products, or gloss preserver, e.g. wax. These products are only suitable for high-gloss surfaces. Their use on vehicles with matte finish leads to considerable surface damage (shiny, spotted areas). Always have paintwork repairs carried out at a qualified specialist workshop.

! Do not use wash programs with a hot wax treatment under any circumstances.

Observe these notes if your vehicle has a clear matte finish. This will help you to avoid damage to the paintwork due to incorrect treatment.

These notes also apply to light alloy wheels with a clear matte finish.

- i** The vehicle should preferably be washed by hand using a soft sponge, car shampoo and plenty of water.
- i** Use only insect remover and car shampoo from the range of recommended and approved Mercedes-Benz care products.

Cleaning the windows

WARNING

Switch off the windshield wipers and remove the SmartKey from the ignition lock before cleaning the windshield or the wiper blades. The windshield wipers could otherwise move and injure you.

- !** Only fold the windshield wipers away from the windshield when vertical. Otherwise, you will damage the hood.
- !** Do not use dry cloths, abrasive products, solvents or cleaning agents containing solvents to clean the inside of the windows. Do not touch the insides of the windows with hard objects, e.g. an ice scraper or ring. There is otherwise a risk of damaging the windows.
- !** Clean the water drainage channels of the windshield and the rear window at regular intervals. Deposits such as leaves, petals and pollen may under certain circumstances prevent water from draining away. This can lead to corrosion damage and damage to electronic components.
- ▶ Clean the inside and outside of the windows with a damp cloth and a cleaning agent that is recommended and approved by Mercedes-Benz.

Cleaning the wiper blades

WARNING

Switch off the windshield wipers and remove the SmartKey from the ignition lock before

cleaning the windshield or the wiper blades. The windshield wipers could otherwise move and injure you.

- !** Only fold the windshield wipers away from the windshield when vertical. Otherwise, you will damage the hood.
- !** Do not pull the wiper blade. Otherwise, the wiper blade could be damaged.
- !** Do not clean wiper blades too often and do not rub them too hard. Otherwise, the graphite coating could be damaged. This could cause wiper noise.
- ▶ Fold the windshield wiper arms away from the windshield.
- ▶ Carefully clean the wiper blades with a damp cloth.
- ▶ Fold the windshield wiper arms back again before switching on the ignition.
- !** Hold the wiper arm securely when folding back. The windshield could be damaged if the wiper arm smacks against it suddenly.

Cleaning the exterior lighting

- !** Only use cleaning agents or cleaning cloths which are suitable for plastic light lenses. Unsuitable cleaning agents or cleaning cloths could scratch or damage the plastic light lenses.
- ▶ Clean the plastic lenses of the exterior lighting using a wet sponge and a mild cleaning agent, e.g. Mercedes-Benz car shampoo or cleaning cloths.

Cleaning the mirror turn signals

- !** Only use cleaning agents or cleaning cloths that are suitable for plastic lenses. Unsuitable cleaning agents or cleaning cloths could scratch or damage the plastic lenses of the mirror turn signals.
- ▶ Clean the plastic lenses of the mirror turn signals in the exterior mirror housing using a wet sponge and a mild cleaning agent,

e.g. Mercedes-Benz car shampoo or cleaning cloths.

Cleaning the sensors

! If you clean the sensors with a power washer, make sure that you keep a distance of at least 11.8 in (30 cm) between the vehicle and the power washer nozzle. Information about the correct distance is available from the equipment manufacturer.

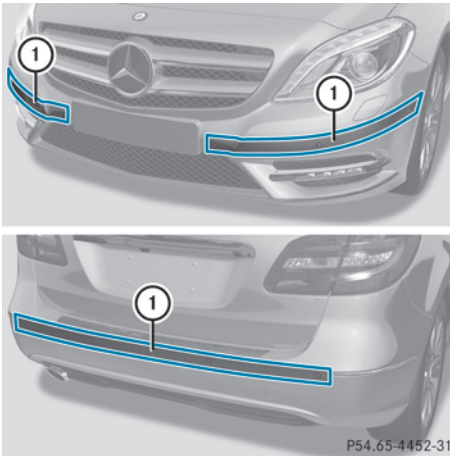

▶ Clean sensors ① of the driving systems with water, car shampoo and a soft cloth.

Cleaning the rear view camera

! Do not clean the camera lens and the area around the rear view camera with a power washer.

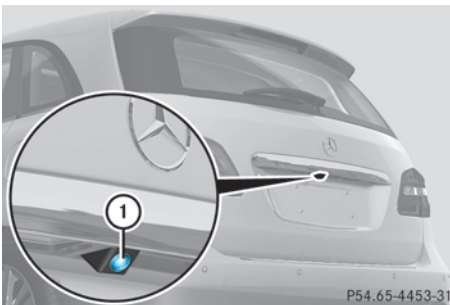

▶ Use clear water and a soft cloth to clean camera lens ①.

Cleaning the exhaust pipe

! Do not clean the exhaust pipe with acid-based cleaning agents such as sanitary cleansers or wheel cleaners.

▶ Clean the exhaust pipe with a chrome care product tested and approved by Mercedes-Benz.

Impurities combined with the effects of road grit and corrosive environmental factors may cause flash rust to form on the surface. You can restore the original shine of the exhaust pipe by cleaning it regularly, especially in winter and after washing.

Interior care

Cleaning the display

! For cleaning, do not use any of the following:

- alcohol-based thinner or gasoline
- abrasive cleaning agents
- commercially-available household cleaning agents

These may damage the display surface. Do not put pressure on the display surface when cleaning. This could lead to irreparable damage to the display.

- ▶ Before cleaning the display, make sure that it is switched off and has cooled down.
- ▶ Clean the display surface using a commercially available microfiber cloth and TFT/LCD display cleaner.
- ▶ Dry the display surface using a dry microfiber cloth.

Cleaning the plastic trim

⚠ WARNING

When cleaning the steering wheel boss and dashboard, do not use cockpit sprays or

cleaning agents containing solvents. Cleaning agents containing solvents cause the surface to become porous, and as a result, plastic parts may break away and be thrown around the interior when an air bag is deployed, which may result in severe injuries.

❗ Do not affix the following to plastic surfaces:

- stickers
- films
- scented oil bottles or similar items

You can otherwise damage the plastic.

❗ Do not allow cosmetics, insect repellent or sunscreen to come into contact with the plastic trim. This maintains the high-quality look of the surfaces.

- ▶ Wipe the plastic trim with a damp, lint-free cloth, e.g. a microfiber cloth.
- ▶ **Heavy soiling:** use car care and cleaning products recommended and approved by Mercedes-Benz.
The surface may change color temporarily. Wait until the surface is dry again.

Cleaning the steering wheel and gear or selector lever

- ▶ Thoroughly wipe with a damp cloth or use leather care agents that have been recommended and approved by Mercedes-Benz.

Cleaning genuine wood and trim elements

❗ Do not use solvent-based cleaning agents such as tar remover, wheel cleaners, polishes or waxes. There is otherwise a risk of damaging the surface.

❗ Do not use chrome polish on trim pieces. The trim pieces have a chrome look but are mostly made of anodized aluminum and can lose their shine if chrome polish is used. Use a damp, lint-free cloth instead when cleaning the trim pieces.

If the chrome-plated trim pieces are very dirty, you can use a chrome polish. If you are unsure as to whether the trim pieces are chrome-plated or not, consult an authorized Mercedes-Benz Center.

- ▶ Wipe the wooden trim and trim pieces with a damp, lint-free cloth, e.g. a microfiber cloth.
- ▶ **Heavy soiling:** use car care and cleaning products recommended and approved by Mercedes-Benz.

Cleaning the seat covers

General notes

❗ Do not use microfiber cloths to clean genuine leather, artificial leather or Alcantara® covers. If used often, these can damage the cover.

i Note that regular care is essential to ensure that the appearance and comfort of the covers is retained over time.

Genuine leather seat covers

Leather is a natural product.

It exhibits natural surface characteristics, for example:

- Differences in the texture
- Signs of stretching and marking
- Slight nuances of color

These are characteristics of leather and not material defects.

❗ To retain the natural appearance of the leather, observe the following cleaning instructions:

- Clean genuine leather covers carefully with a damp cloth and then wipe the covers down with a dry cloth.
- Make sure that the leather does not become soaked. It may otherwise become rough and cracked.
- Only use leather care agents that have been tested and approved by Mercedes-

Benz. You can obtain these from a qualified specialist workshop.

Seat covers of other materials

⚠ Observe the following when cleaning:

- Clean artificial leather covers with a cloth moistened with a solution containing 1% detergent (e.g. dish washing liquid).
- Clean cloth covers with a microfiber cloth moistened with a solution containing 1% detergent (e.g. dish washing liquid). Rub carefully and always wipe entire seat sections to avoid leaving visible lines. Leave the seat to dry afterwards. Cleaning results depend on the type of dirt and how long it has been there.
- Clean Alcantara® covers with a damp cloth. Make sure that you wipe entire seat sections to avoid leaving visible lines.

Cleaning the seat belts

WARNING

Do not bleach or dye seat belts as this may severely weaken them. In a crash, they may not be able to provide adequate protection.

- ⚠ Do not clean the seat belts using chemical cleaning agents. Do not dry the seat belts by heating at temperatures above 176 °F (80 °C) or in direct sunlight.
- ▶ Use clean, lukewarm water and soap solution.

Cleaning the headliner and carpets

- ▶ **Headliner:** if it is very dirty, use a soft brush or a cleaning agent recommended and approved by Mercedes-Benz.
- ▶ **Carpets:** use the carpet and textile cleaning agents recommended and approved by Mercedes-Benz.

Useful information	274
Where will I find...?	274
Flat tire	275
Battery (vehicle)	279
Jump-starting	283
Towing and tow-starting	285
Fuses	287

Useful information

- i** This Operator's Manual describes all models and all standard and optional equipment of your vehicle available at the time of publication of the Operator's Manual. Country-specific differences are possible. Please note that your vehicle may not be equipped with all features described. This also applies to safety-related systems and functions.
- i** Please read the information on qualified specialist workshops (▷ page 23).

Where will I find...?

First-aid kit

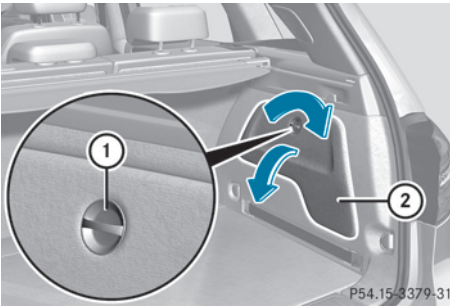

- ▶ Open the tailgate.
- ▶ **To open the stowage compartment:** turn rotary knob ① clockwise and fold down cover ②.

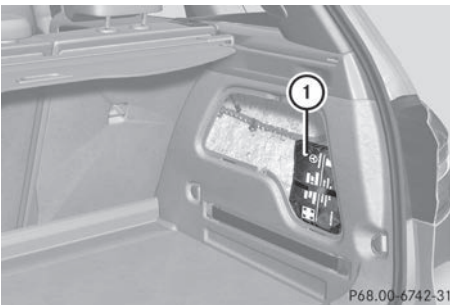

- ▶ Remove first-aid kit ③.

- i** Check the expiration date on the first-aid kit at least once a year. Replace the contents if necessary, and replace missing items.

Vehicle tool kit

General notes

Vehicles with the TIREFIT kit: the TIREFIT kit is in the stowage well beneath the cargo compartment floor.

Vehicles with a tire-change tool kit: the tire-change tool kit is in the stowage well beneath the cargo compartment floor.

- i** Apart from certain country-specific variations, the vehicles are not equipped with a tire-change tool kit. Some tools for changing a wheel are specific to the vehicle. For more information on which tools are required to perform a wheel change on your vehicle, consult a qualified specialist workshop.

Tools required for changing a wheel may include, for example:

- Jack
- Wheel chock
- Lug wrench

Vehicles with a TIREFIT kit

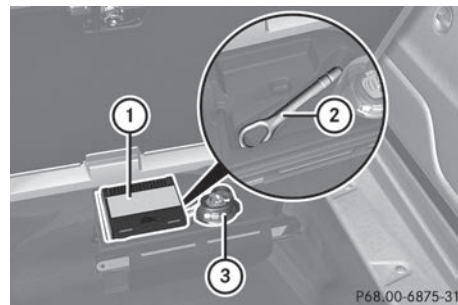

- ① Tire inflation compressor
- ② Towing eye
- ③ Tire sealant filler bottle

- ▶ Open the tailgate.
- ▶ Lift the cargo compartment floor up (▷ page 239).
- ▶ **i** Towing eye ② is located under tire inflation compressor ①.

Vehicles with a tire-change tool kit

- ▶ Open the tailgate.
- ▶ Lift the cargo compartment floor up (▷ page 239).
- ▶ Remove the tire-change tool kit.

The tire-change tool kit contains:

- Jack
- Lug wrench
- One pair of gloves
- Folding wheel chock

Flat tire

Preparing the vehicle

Your vehicle may be equipped with:

- MOExtended tires (tires with run-flat properties) (▷ page 275)
- a TIREFIT kit

Information on mounting a wheel (▷ page 312).

Vehicle preparation is not necessary on vehicles with MOExtended tires.

- ▶ Stop the vehicle on solid, non-slippery and level ground, as far away as possible from traffic.
- ▶ Switch on the hazard warning lamps.
- ▶ Secure the vehicle against rolling away (▷ page 141).
- ▶ If possible, bring the front wheels into the straight-ahead position.
- ▶ Switch off the engine.
- ▶ Remove the SmartKey from the ignition lock.

- ▶ All occupants must get out of the vehicle. Make sure that they are not endangered as they do so.
- ▶ Make sure that no one is near the danger area while a wheel is being changed. Anyone who is not directly assisting in the wheel change should, for example, stand behind the barrier.
- ▶ Get out of the vehicle. Pay attention to traffic conditions when doing so.
- ▶ Close the driver's door.

- ▶ **i** Vehicles equipped with MOExtended tires are not equipped with a TIREFIT kit at the factory. It is therefore recommended that you additionally equip your vehicle with a TIREFIT kit if you mount tires that do not feature run-flat properties, e.g. winter tires. A TIREFIT kit can be obtained from a qualified specialist workshop.

MOExtended tires (tires with run-flat properties)

WARNING

When driving in emergency mode, the driving characteristics deteriorate, e.g. when cornering, accelerating quickly and when braking. There is a risk of an accident.

Do not exceed the stated maximum speed. Avoid abrupt steering and driving maneuvers, and driving over obstacles (curbs, potholes, off-road). This applies in particular to a laden vehicle.

Stop driving in emergency mode if:

- you hear banging noises.
- the vehicle starts to shake.
- you see smoke and smell rubber.
- ESP® is intervening constantly.
- there are tears in the sidewalls of the tire.

After driving in emergency mode, have the wheel rims checked at a qualified specialist workshop with regard to their further use. The defective tire must be replaced in every case.

With MOExtended tires (tires with run flat characteristics), you can continue to drive your vehicle even if there is a total loss of pressure in one or more tires.

MOExtended tires may only be used in conjunction with an active tire pressure loss warning system.

The maximum driving distance is approximately 50 miles (80 km) when the vehicle is partially laden and approximately 18 miles (30 km) when the vehicle is fully laden.

In addition to the vehicle load, the driving distance possible depends upon:

- speed
- road condition
- outside temperature

The driving distance possible in run-flat mode may be reduced by extreme driving conditions/maneuvers, or it can be increased through a moderate style of driving.

The maximum permissible distance which can be driven in run-flat mode is counted from the moment the tire pressure loss warning appears in the multifunction display.

You must not exceed a maximum speed of 50 mph (80 km/h).

- i** When changing or replacing one or all of the tires, note the label "MOExtended". Take note also of the size specified for the vehicle.
- i** Vehicles equipped with MOExtended tires are not equipped with a TIREFIT kit at the factory. It is therefore recommended that you additionally equip your vehicle with a TIREFIT kit if you mount tires that do not feature run-flat properties, e.g. winter tires. A TIREFIT kit is available, for example, from a qualified specialist workshop.

TIREFIT kit

Using the TIREFIT kit

TIREFIT is a tire sealant.

TIREFIT can be used to seal small punctures of up to 0.16 inches (4 mm), particularly on the tire tread. You can use TIREFIT at outside temperatures down to -4 °F (-20 °C).

WARNING

In the following situations, the tire sealant is unable to provide sufficient breakdown assistance, as it is unable to seal the tire properly:

- there are cuts or punctures in the tire larger than those mentioned above.
- the wheel rim is damaged.
- you have driven at very low tire pressures or on a flat tire.

There is a risk of an accident.

Do not drive any further. Contact a qualified specialist workshop.

WARNING

The tire sealant is harmful and causes irritation. It must not come into contact with your skin, eyes or clothing or be swallowed. Do not inhale TIREFIT fumes. Keep tire sealant away from children. There is a risk of injury. If you come into contact with the tire sealant, observe the following:

- Rinse off the tire sealant from your skin immediately with water.
- If the tire sealant comes into contact with your eyes, immediately rinse them thoroughly with clean water.
- If tire sealant is swallowed, immediately rinse your mouth out thoroughly and drink plenty of water. Do not induce vomiting, and seek medical attention immediately.
- Immediately change out of clothing which has come into contact with tire sealant.
- If an allergic reaction occurs, seek medical attention immediately.

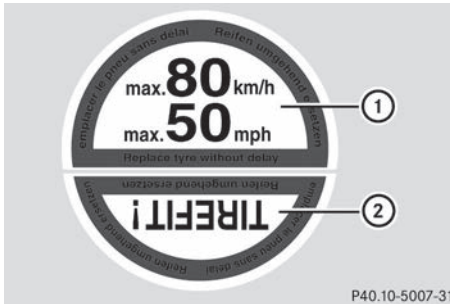

P40.10-5007-31

TIREFIT sticker, 2-part

- ▶ Do not remove any foreign objects which have penetrated the tire, e.g. screws or nails.
- ▶ Remove the tire sealant bottle, the accompanying TIREFIT sticker and the tire inflation compressor from the stowage well underneath the cargo compartment floor (> page 274).
- ▶ Affix part ① of the TIREFIT sticker within the driver's field of vision.
- ▶ Affix part ② of the TIREFIT sticker near the valve on the wheel with the defective tire.

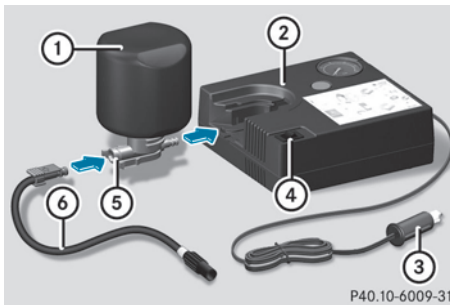

P40.10-6009-31

- ▶ Remove filler hose ⑥ and plug ③ from the bottom section of the tire inflation compressor housing.
- ▶ Slide the yellow filler hose connector into the mounting on yellow cap ⑤ of tire sealant bottle ① until the plug engages.
- ▶ With the sealing rings in front, slide yellow cap ⑤ of tire sealant bottle ① into the mounting of tire inflation compressor ② until the cap and both hooks engage.

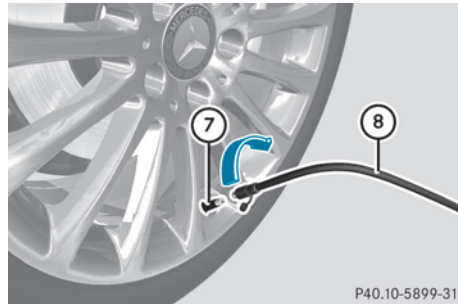

P40.10-5899-31

- ▶ Remove the cap from valve ⑦ on the faulty tire.
- ▶ Screw filler hose ⑧ onto valve.
- ▶ Insert plug ③ into the socket of the cigarette lighter (> page 243) or into a 12 V power socket in your vehicle (> page 244).
- ▶ Turn the SmartKey to position 1 (> page 127) in the ignition lock.
- ▶ Press on/off switch ④ on the tire inflation compressor to **ON**.
The tire inflation compressor is switched on. The tire is inflated.

i First, tire sealant is pumped into the tire. The pressure can briefly rise to approximately 500 kPa (5 bar/73 psi).

Do not switch off the tire inflation compressor during this phase.

- ▶ Let the tire inflation compressor run for a maximum of ten minutes. The tire should then have attained a pressure of at least 200 kPa (2.0 bar/29 psi).

! Do not operate the tire inflation compressor for longer than ten minutes at a time without a break. It may otherwise overheat.

The tire inflation compressor can be operated again once it has cooled down.

If a pressure of 200 kPa (2.0 bar/29 psi) has been attained after a maximum of ten minutes, see (> page 278).

If a pressure of 200 kPa (2.0 bar/29 psi) has not been attained after a maximum of ten minutes, see (> page 278).

i If tire sealant leaks out, allow it to dry. It can then be removed like a layer of film.

If your clothes are soiled with tire sealant, have them cleaned with perchloroethylene at a dry cleaner as soon as possible.

Tire pressure not reached

If a pressure of 200 kPa (2.0 bar/29 psi) has not been achieved after ten minutes:

- ▶ Switch off the tire inflation compressor.
 - ▶ Unscrew the filler hose from the valve of the faulty tire.
 - ▶ Very slowly drive forwards or reverse approximately 30 ft (10 m).
 - ▶ Pump up the tire again.
- After a maximum of ten minutes, the tire pressure must be at least 200 kPa (2.0 bar/29 psi).

WARNING

If the required tire pressure is not reached after the specified time, the tire is too badly damaged. The tire sealant cannot repair the tire in this instance. Damaged tires and a tire pressure that is too low can significantly impair the vehicle's braking and driving characteristics. There is a risk of accident.

Do not continue driving. Contact a qualified specialist workshop.

Tire pressure reached

WARNING

A tire temporarily sealed with tire sealant impairs the driving characteristics and is not suitable for higher speeds. There is a risk of accident.

You should therefore adapt your driving style accordingly and drive carefully. Do not exceed the specified maximum speed with a tire that has been repaired using tire sealant.

! After use, excess tire sealant may run out of the filler hose. This could cause stains.

Therefore, place the filler hose in the plastic bag that contained the TIREFIT kit.

Environmental note

Have the used tire sealant bottle disposed of professionally, e.g. at a qualified specialist workshop.

If a pressure of 200 kPa (2.0 bar/29 psi) has been attained after a maximum of ten minutes:

- ▶ Switch off the tire inflation compressor.
- ▶ Unscrew the filler hose from the valve of the faulty tire.
- ▶ Stow the tire sealant bottle and the tire inflation compressor.
- ▶ **Pull away immediately.**

The maximum speed for a tire treated with tire sealant is 50 mph (80 km/h). The upper part of the TIREFIT sticker must be affixed to the instrument cluster in the driver's field of vision.

- ▶ Stop after driving for approximately ten minutes and check the tire pressure with the tire inflation compressor.
- The tire pressure must now be at least 130 kPa (1.3 bar/19 psi).

WARNING

If the required tire pressure is not reached after driving for a short period, the tire is too badly damaged. The tire sealant cannot repair the tire in this instance. Damaged tires and a tire pressure that is too low can significantly impair the vehicle's braking and driving characteristics. There is a risk of accident.

Do not continue driving. Contact a qualified specialist workshop.

- ▶ Correct the tire pressure if it is still at least 130 kPa (1.3 bar/19 psi) (for the values, see the Tire and Loading Information placard on the driver's side B-pillar or tire pressure table on the fuel filler flap).

- ▶ **To increase the tire pressure:** switch on the tire inflation compressor.

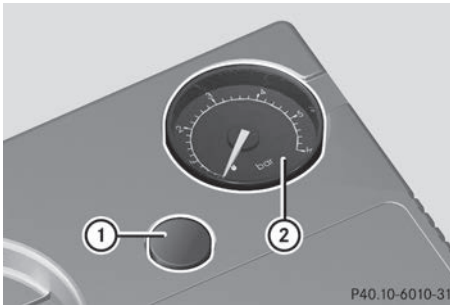

- ▶ **To reduce the tire pressure:** depress pressure release button ① next to pressure gage ②.

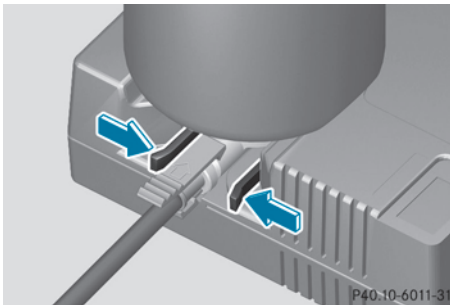

- ▶ To remove the tire sealant bottle from the tire inflation compressor, press together the locking tabs on the yellow cap.
- ▶ Pull the tire sealant bottle out of the tire inflation compressor.
The filler hose remains attached to the tire sealant bottle.
- ▶ Stow the tire sealant bottle and the tire inflation compressor.
- ▶ Drive to the nearest qualified specialist workshop and have the tire changed there.
- ▶ Have the tire sealant bottle and the filler hose replaced as soon as possible at a qualified specialist workshop.
- ▶ Have the tire sealant bottle replaced every four years at a qualified specialist workshop.

Battery (vehicle)

Important safety notes

Special tools and expert knowledge are required when working on the battery, e.g. removal and installing. You should therefore have all work involving the battery carried out at a qualified specialist workshop.

WARNING

Work carried out incorrectly on the battery can, for example, lead to a short circuit and damage your vehicle's electronic system. This can disrupt driving safety systems such as ABS (anti-lock braking system) or ESP® (Electronic Stability Program).

- If ABS malfunctions, the wheels can lock during braking. This limits the steerability of the vehicle when braking and the braking distance may increase. There is a risk of accident.
- If ESP® malfunctions, the vehicle will not be stabilised if it starts to skid or a wheel starts to spin. There is a risk of accident.

You should therefore have all work involving the battery carried out at a qualified specialist workshop.

WARNING

Electrostatic build-up can lead to the creation of sparks, which could ignite the highly explosive gases of a battery. There is a risk of an explosion.

Before handling the battery, touch the vehicle body to remove any existing electrostatic build-up.

The highly flammable gas mixture forms when charging the battery as well as when jump-starting.

Always make sure that neither you nor the battery is electrostatically charged. There is a build-up of electrostatic charge, e.g.:

- by wearing clothing made from synthetic fibers
- due to friction between clothing and seats

- if you push or pull the battery across the carpet or other synthetic materials
- if you wipe the battery with a cloth.

WARNING

During the charging process, a battery produces hydrogen gas. If a short circuit occurs or sparks are created, the hydrogen gas can ignite. There is a risk of an explosion.

- Make sure that the positive terminal of a connected battery does not come into contact with vehicle parts.
- Never place metal objects or tools on a battery.
- It is important that you observe the described order of the battery terminals when connecting and disconnecting a battery.
- When jump-starting, make sure that the battery poles with identical polarity are connected.
- It is particularly important to observe the described order when connecting and disconnecting the jumper cables.
- Never connect or disconnect the battery terminals while the engine is running.

WARNING

Battery acid is caustic. There is a risk of injury. Avoid contact with the skin, eyes or clothing. Do not inhale any battery gases. Do not lean over the battery. Keep children away from batteries. Wash battery acid immediately with water and seek medical attention.

Environmental note



Batteries contain dangerous substances. It is against the law to dispose of them with the household rubbish. They must be collected separately and recycled to protect the environment.



Dispose of batteries in an environmentally friendly manner. Take discharged

batteries to a qualified specialist workshop or a special collection point for used batteries.

-  Have the battery checked regularly at a qualified specialist workshop.

Observe the service intervals in the Maintenance Booklet or contact a qualified specialist workshop for more information.

-  You should have all work involving the battery carried out at a qualified specialist workshop. In the exceptional case that it is necessary for you to disconnect the battery yourself, make sure that:

- you switch off the engine and remove the SmartKey. Check that all the indicator lamps in the instrument cluster are off. Otherwise, electronic components, such as the alternator, may be damaged.
- you first remove the negative terminal clamp and then the positive terminal clamp. Never swap the terminal clamps. Otherwise, the vehicle's electronic system may be damaged.
- on vehicles with automatic transmission, the transmission is locked in position **P** after disconnecting the battery. The vehicle is secured against rolling away. You can then no longer move the vehicle.

The battery and the cover of the positive terminal clamp must be installed securely during operation.

Comply with safety precautions and take protective measures when handling batteries.



WARNING



Fire, open flames and smoking are prohibited when handling the battery. Avoid creating sparks.



Battery acid is caustic. Avoid contact with the skin, eyes or clothing.

Wear suitable protective clothing, in particular gloves, an apron and a face mask.

Immediately rinse acid splashes off with clean water. Consult a doctor if necessary.

Wear eye protection.



Keep children away.



Observe this Operator's Manual.

For safety reasons, Mercedes-Benz recommends that you only use batteries which have been tested and approved for your vehicle by Mercedes-Benz. These batteries provide increased impact protection to prevent vehicle occupants from suffering acid burns should the battery be damaged in the event of an accident.

In order for the battery to achieve the maximum possible service life, it must always be sufficiently charged.

Like other batteries, the vehicle battery may discharge over time if you do not use the vehicle. In this case, have the battery disconnected at a qualified specialist workshop. You can also charge the battery with a charger recommended by Mercedes-Benz. Contact a qualified specialist workshop for further information.

Have the battery charge level checked more frequently if you use the vehicle mainly for short trips or if you leave it standing idle for a lengthy period. Consult a qualified specialist workshop if you wish to leave your vehicle parked for a long period of time.

Only replace a battery with a battery that has been recommended by Mercedes-Benz.

i Remove the SmartKey if you park the vehicle and do not require any electrical consumers. The vehicle will then use very little energy, thus conserving battery power.

i If the power supply has been interrupted, e.g. if you reconnect the battery, you will have to:

- set the clock (audio system/COMAND, see the separate operating instructions).
- reset the function for folding the exterior mirrors in/out automatically, by folding the mirrors out once (> page 91).

Charging the battery

WARNING

During charging and jump-starting, explosive gases can escape from the battery. There is a risk of an explosion.

Particularly avoid fire, open flames, creating sparks and smoking. Ensure there is sufficient ventilation while charging and jump-starting. Do not lean over a battery.

WARNING

Battery acid is caustic. There is a risk of injury. Avoid contact with the skin, eyes or clothing. Do not inhale any battery gases. Do not lean over the battery. Keep children away from batteries. Wash battery acid immediately with water and seek medical attention.

WARNING

A discharged battery can freeze at temperatures below freezing point. When jump-starting the vehicle or charging the battery, gases can escape from the battery. There is a risk of an explosion. Allow the frozen battery to thaw out before charging it or jump-starting.

! Only use battery chargers with a maximum charging voltage of 14.8 V.

! Only charge the battery using the jump-starting connection point.

The jump-starting connection point is in the engine compartment (▷ page 283).

- ▶ Open the hood (▷ page 260).
- ▶ Connect the battery charger to the positive terminal and ground point in the same order as when connecting the donor battery in the jump-starting procedure (▷ page 283).

If, at low temperatures, the indicator lamps/warning lamps in the instrument cluster do not light up, it is highly likely that the discharged battery has frozen. In this case, you may neither charge the battery nor jump-start the vehicle. The service life of a thawed-out battery may be shorter. The starting characteristics can be impaired, particularly at low temperatures. Have the thawed-out battery checked at a qualified specialist workshop.

Only charge the installed battery with a battery charger which has been tested and approved by Mercedes-Benz. A battery charger unit specially adapted for Mercedes-Benz vehicles and tested and approved by Mercedes-Benz is available as an accessory. It permits the charging of the battery in its installed position. Contact an authorized Mercedes-Benz Center for further information and availability. Read the battery charger's operating instructions before charging the battery.

Jump-starting

WARNING

Battery acid is caustic. There is a risk of injury.

Avoid contact with the skin, eyes or clothing. Do not inhale any battery gases. Do not lean over the battery. Keep children away from batteries. Wash battery acid immediately with water and seek medical attention.

WARNING

During charging and jump-starting, explosive gases can escape from the battery. There is a risk of an explosion.

Particularly avoid fire, open flames, creating sparks and smoking. Ensure there is sufficient ventilation while charging and jump-starting. Do not lean over a battery.

WARNING

During the charging process, a battery produces hydrogen gas. If a short circuit occurs or sparks are created, the hydrogen gas can ignite. There is a risk of an explosion.

- Make sure that the positive terminal of a connected battery does not come into contact with vehicle parts.
- Never place metal objects or tools on a battery.
- It is important that you observe the described order of the battery terminals when connecting and disconnecting a battery.
- When jump-starting, make sure that the battery poles with identical polarity are connected.
- It is particularly important to observe the described order when connecting and disconnecting the jumper cables.
- Never connect or disconnect the battery terminals while the engine is running.

WARNING

Non-combusted fuel can collect in the exhaust system and ignite. There is a risk of fire. Avoid repeated and lengthy starting attempts.

- ❗ Avoid repeated and lengthy starting attempts. Otherwise, the catalytic converter could be damaged by the non-combusted fuel.

Do not start the vehicle using a rapid charging device. If your vehicle's battery is discharged, the engine can be jump-started from another vehicle or from a second battery using jumper cables. Observe the following points:

- The battery is not accessible in all vehicles. If the other vehicle's battery is not accessible, jump-start the vehicle using a second battery or a jump-starting device.
- You may only jump-start the vehicle when the engine and exhaust system are cold.
- Do not start the engine if the battery is frozen. Let the battery thaw first.
- Jump-starting may only be performed from batteries with a nominal voltage of 12 V.
- Only use jumper cables which have a sufficient cross-section and insulated terminal clamps.

- If the battery is fully discharged, leave the battery that is being used to jump-start connected for a few minutes before attempting to start. This charges the empty battery a little.
- Make sure that the two vehicles do not touch.

Make sure that:

- the jumper cables are not damaged.
 - bare parts of the terminal clamp do not come into contact with other metal parts while the jumper cables are connected to the battery.
 - the jumper cables cannot come into contact with parts such as the V-belt pulley or the fan. These parts move when the engine is started and while it is running.
- ▶ Secure the vehicle by applying the electric parking brake.
- ▶ Shift the transmission to position **P**.
- ▶ Turn the SmartKey to position **0** in the ignition lock and remove it.
- ▶ Switch off all electrical consumers (e.g. radio, blower, etc.).
- ▶ Open the hood (▶ page 260).

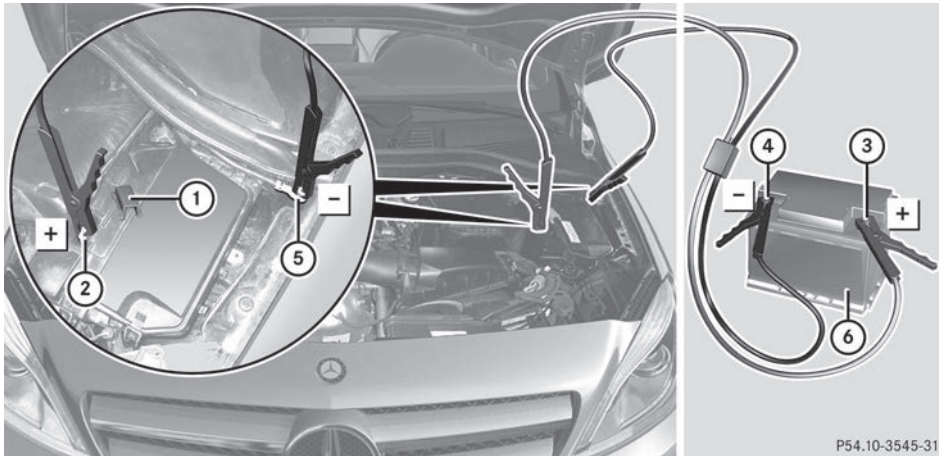

P54.10-3545-31

Position number ⑥ identifies the charged battery of the other vehicle or an equivalent jump-starting device.

- ▶ Press together cover ① of positive clamp ② and slide it back.
- ▶ Connect positive terminal ② on your vehicle to positive terminal ③ of donor battery ⑥ using the jumper cable, beginning with your own battery.
- ▶ Start the engine of the donor vehicle and run it at idling speed.
- ▶ Connect negative terminal ④ of donor battery ⑥ to ground point ⑤ of your vehicle using the jumper cable, connecting the jumper cable to donor battery ⑥ first.
- ▶ Start the engine.
- ▶ Before disconnecting the jumper cables, let the engine run for several minutes.
- ▶ First, remove the jumper cables from ground point ⑤ and negative terminal ④, then from positive terminal ② and positive terminal ③, each time beginning at the contacts on your own vehicle first.

- ▶ Close cover ① of positive terminal ② after removing the jumper cables.
- ▶ Have the battery checked at a qualified specialist workshop.
- i** Jump-starting is not considered to be a normal operating condition.
- i** Jumper cables and further information regarding jump starting can be obtained at any qualified specialist workshop.

Towing and tow-starting

Important safety notes

WARNING

Functions relevant to safety are restricted or no longer available if:

- the engine is not running.
- the brake system or the power steering is malfunctioning.
- there is a malfunction in the voltage supply or the vehicle's electrical system.

If your vehicle is being towed, much more force may be necessary to steer or brake. There is a risk of an accident.

In such cases, use a tow bar. Before towing, make sure that the steering moves freely.

WARNING

If the weight of the vehicle to be towed or tow-started is greater than the permissible gross weight of your vehicle:

- the towing eye could detach itself
- the vehicle/trailer combination could rollover.

There is a risk of an accident.

When towing or tow-starting another vehicle, its weight should not be greater than the permissible gross weight of your vehicle.

Information on your vehicle's gross vehicle weight rating can be found on the vehicle identification plate (▶ page 323).

WARNING

The vehicle is braked if the HOLD function is activated. Therefore, deactivate HOLD if the vehicle is to be towed.

! Only secure the tow rope or tow bar at the towing eyes. Otherwise, the vehicle could be damaged.

! Do not use the towing eye for recovery, as this could damage the vehicle. If in doubt, recover the vehicle with a crane.

! When towing, pull away slowly and smoothly. If the tractive power is too high, the vehicles could be damaged.

! The vehicle can be towed a maximum of 30 miles (50km). The towing speed of 30 mph (50km/h) must not be exceeded. If the vehicle has to be towed more than 30 miles (50km), the front axle must be raised or the entire vehicle raised and transported.

! Do not tow with sling-type equipment. This could damage the vehicle.

! Vehicles with automatic transmission must not be started by tow-starting. This could otherwise damage the transmission.

It is better to have the vehicle transported than to have it towed.

When towing a vehicle, the transmission must be in position **N**.

The battery must be connected and charged. Otherwise, you:

- cannot turn the SmartKey to position **2** in the ignition lock
- cannot shift the transmission to position **N**.

i Deactivate the automatic locking feature (▶ page 191). You could otherwise be locked out when pushing or towing the vehicle.

Installing/removing the towing eye

Installing the towing eye

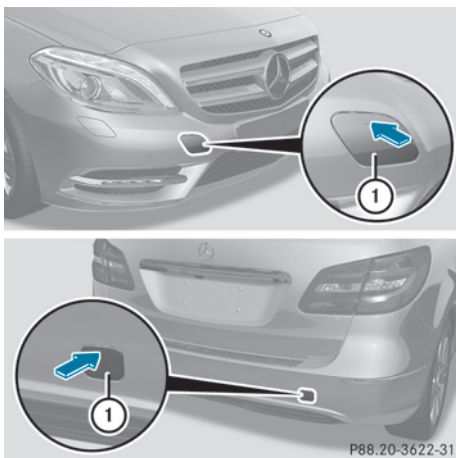

- ▶ Remove the towing eye from the stowage space.
The towing eye is beneath the cargo compartment floor with the vehicle tool kit (▷ page 274).
Vehicles with the TIREFIT kit: the towing eye is beneath the tire inflation compressor.
- ▶ Press the mark on cover ① inwards in the direction of the arrow.
- ▶ Take cover ① off the opening.
- ▶ Screw the towing eye in clockwise to the stop and tighten it.

Removing the towing eye

- ▶ Loosen the towing eye and unscrew it.
- ▶ Attach cover ① to the bumper and press until it engages.
- ▶ Place the towing eye in the stowage well beneath the cargo compartment floor (▷ page 274) in the cargo compartment.
- ▶ Vehicles with the TIREFIT kit: put back the tire inflation compressor.

Towing the vehicle with the front axle raised

- ⚠ The ignition must be switched off if the vehicle is being towed with the front axle raised. Otherwise, ESP® may intervene and damage the brake system.
- ▶ Turn the SmartKey to position **2** in the ignition lock.
- ▶ When the vehicle is stationary, depress the brake pedal and keep it depressed.
- ▶ Shift the automatic transmission to position **P**.
- ▶ Release the brake pedal.
- ▶ Release the electric parking brake.
- ▶ Deactivate automatic locking (▷ page 191).
- ▶ Switch on the hazard warning lamps (▷ page 99).
- ▶ Turn the SmartKey to position **0** in the ignition lock and leave the SmartKey in the ignition lock.

When towing your vehicle with the front axle raised, it is important that you observe the safety instructions (▷ page 285).

Towing a vehicle with both axles on the ground

⚠ WARNING

The power assistance for the steering and the brake force booster do not work when the engine is not running. You will then need much more effort to brake and steer the vehicle. Adapt your style of driving accordingly.

- ⓘ In order to signal a change of direction when towing with the hazard warning lamps switched on, use the combination switch as usual. In this case, only the turn signals for the desired direction flash. When you reset the combination switch, the hazard warning lamps start flashing again.

The automatic transmission automatically shifts to position **P** when you open the driver's or front-passenger door or when you remove the SmartKey from the ignition lock. In order to ensure that the automatic transmission stays in position **N** when towing the vehicle, you must observe the following points:

- ▶ Make sure that the vehicle is stationary.
- ▶ Turn the SmartKey to position **2** in the ignition lock.
- ▶ Depress and hold the brake pedal.
- ▶ Shift the automatic transmission to position **N**.
- ▶ Leave the SmartKey in position **2** in the ignition lock.
- ▶ Release the brake pedal.
- ▶ Release the electric parking brake.
- ▶ Switch on the hazard warning lamps (▷ page 99).

It is important that you observe the safety instructions when towing away your vehicle (▷ page 285).

Transporting the vehicle

! Only lash the vehicle down by the wheels or wheel rims, not by parts of the vehicle such as axle or steering components. Otherwise, the vehicle could be damaged.

- ▶ Turn the SmartKey to position **2** in the ignition lock.
- ▶ Shift the transmission to position **N**.

As soon as the vehicle is loaded:

- ▶ Prevent the vehicle from rolling away by applying the electric parking brake.
- ▶ Shift the transmission to position **P**.
- ▶ Turn the SmartKey to position **0** in the ignition lock and remove it.
- ▶ Secure the vehicle.

The towing eye can be used to pull the vehicle onto a trailer or transporter for transporting purposes.

Tow-starting (emergency starting)

! Vehicles with automatic transmission must not be tow-started. You could otherwise damage the automatic transmission.

When tow-starting, it is important that you observe the safety instructions (▷ page 285).

Fuses

Important safety notes

WARNING

Only use fuses that have been approved for Mercedes-Benz vehicles and that have the correct fuse rating for the systems concerned. Do not attempt to repair or bridge faulty fuses. Using fuses that have not been approved or attempting to repair or bridge faulty fuses could cause the fuse to be overloaded and result in a fire. Have the cause traced and rectified at a qualified specialist workshop.

! Only use fuses that have been approved for Mercedes-Benz vehicles and which have the correct fuse rating for the system concerned. Only use fuses marked with an "S". Otherwise, components or systems could be damaged.

The fuses in your vehicle serve to close down faulty circuits. If a fuse blows, all the components on the circuit and their functions stop operating.

Blown fuses must be replaced with fuses of the same rating, which you can recognize by the color and value. The fuse ratings are listed in the fuse allocation chart.

If a newly inserted fuse also blows, have the cause traced and rectified at a qualified specialist workshop, e.g. an authorized Mercedes-Benz Center.

Before changing a fuse

- ▶ Secure the vehicle against rolling away (▷ page 141).
- ▶ Switch off all electrical consumers.
- ▶ Turn the SmartKey to position **0** in the ignition lock and remove it (▷ page 127). All indicator lamps in the instrument cluster must be off.

The fuses are located in various fuse boxes:

- Fuse box in the engine compartment on the left-hand side of the vehicle, when viewed in the direction of travel
- Fuse box in the front-passenger footwell

The fuse allocation chart is on the fuse box in the front-passenger footwell (▷ page 288).

Fuse box in the engine compartment

- ❗ Make sure that no moisture can enter the fuse box when the cover is open.
- ❗ When closing the cover, make sure that it is lying correctly on the fuse box. Moisture seeping in or dirt could otherwise impair the operation of the fuses.

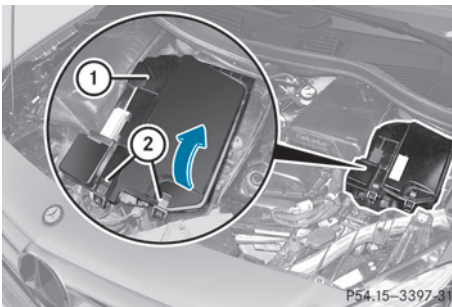

- ▶ Open the hood.
- ▶ Remove any existing moisture from the fuse box using a dry cloth.
- ▶ **To open:** open clamps (2).
- ▶ Fold up cover (1) in the direction of the arrow and remove it.

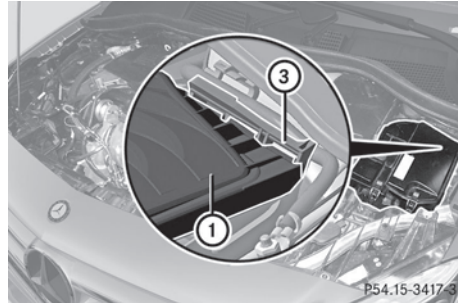

- ▶ **To close:** check whether the seal is seated correctly in cover (1).
- ▶ Insert cover (1) at the back into openings (3) on the fuse box.
- ▶ Fold down cover (1).
- ▶ Hook clamps (2) into the fuse box and close.
- ▶ Close the hood.

Fuse box in the front-passenger footwell

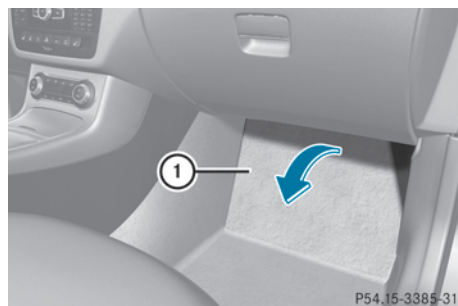

- ▶ **To open:** remove the floormat from the front-passenger side.
- ▶ Fold out perforated floor covering (1) in the direction of the arrow.

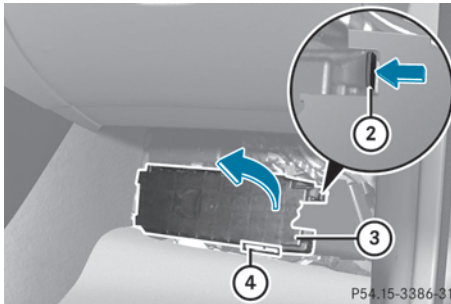

- ▶ To release cover (3), press retaining clamp (2).
- ▶ Fold out cover (3) in the direction of the arrow to the catch.
- ▶ Remove cover (3) forwards.
- ▶ **i** Fuse allocation chart (4) is located on the lower right-hand side of cover (3).
- ▶ **To close:** insert cover (3) on the left-hand side of the fuse box into the retainer. Cover (3) engages in the retainers.
- ▶ Fold down cover (3) until clamps (2) lock audibly.
- ▶ Fold back perforated floor covering (1).

Useful information	292
Important safety notes	292
Operation	292
Winter operation	294
Tire pressure	295
Loading the vehicle	300
Maximum load rating	303
Uniform Tire Quality Grading Standards	304
Tire labeling	305
Definition of terms for tires and loading	309
Changing a wheel	312
Wheel and tire combinations	316
Emergency spare wheel	318

Useful information

- i** This Operator's Manual describes all models and all standard and optional equipment of your vehicle available at the time of publication of the Operator's Manual. Country-specific differences are possible. Please note that your vehicle may not be equipped with all features described. This also applies to safety-related systems and functions.
- i** Please read the information on qualified specialist workshops (▷ page 23).

Important safety notes

WARNING

If wheels and tires of the wrong size are used, the wheel brakes or suspension components may be damaged. There is a risk of accident. Always replace wheels and tires with those that fulfill the specifications of the original part (designation, manufacturer, model).

WARNING

A flat tire severely impairs the driving, steering and braking characteristics of the vehicle. There is a risk of accident.

Tires without run-flat characteristics:

- do not drive with a flat tire.
- immediately replace the flat tire with your emergency spare wheel or spare wheel, or consult a qualified specialist workshop.

Tires with run-flat characteristics:

- pay attention to the information and warning notices on MOExtended tires (tires with run-flat characteristics).

Accessories that are not approved for your vehicle by Mercedes-Benz or are not being used correctly can impair the operating safety.

Before purchasing and using non-approved accessories, visit a qualified specialist workshop and inquire about:

- suitability
- legal stipulations
- factory recommendations

For information on dimensions and types of wheels and tires for your vehicle, see (▷ page 316).

Information on air pressure for the tires on your vehicle can be found:

- on the vehicle's Tire and Loading Information placard on the B-pillar
- on the tire pressure label on the fuel filler flap
- under "tire pressure"

i Further information on wheels and tires can be obtained at any qualified specialist workshop.

Operation

Information on driving

- If the vehicle is heavily laden, check the tire pressures and correct them if necessary.
- While driving, pay attention to vibrations, noises and unusual handling characteristics, e.g. pulling to one side. This may indicate that the wheels or tires are damaged. If you suspect that a tire is defective, reduce your speed immediately. Stop the vehicle as soon as possible to check the wheels and tires for damage. Hidden tire damage could also be causing the unusual handling characteristics. If you find no signs of damage, have the wheels and tires checked at a qualified specialist workshop.
- When parking your vehicle, make sure that the tires do not get deformed by the curb or other obstacles. If it is necessary to drive over curbs, speed humps or similar elevations, try to do so slowly and at an obtuse angle. Otherwise, the tires,

particularly the sidewalls, may be damaged.

Regular checking of wheels and tires

WARNING

Damaged tires can cause tire inflation pressure loss. As a result, you could lose control of your vehicle. There is a risk of accident.

Check the tires regularly for signs of damage and replace any damaged tires immediately.

Regularly check the wheels and tires of your vehicle for damage at least once a month, as well as after driving off-road or on rough roads. Damaged wheels can cause a loss of tire pressure. Pay particular attention to damage such as:

- cuts in the tires
- punctures
- tears in the tires
- bulges on tires
- deformation or severe corrosion on wheels

Regularly check the tire tread depth and the condition of the tread across the whole width of the tire (> page 293). If necessary, turn the front wheels to full lock in order to inspect the inner side of the tire surface.

All wheels must have a valve cap to protect the valve against dirt and moisture. Do not mount anything onto the valve other than the standard valve cap or other valve caps approved by Mercedes-Benz for your vehicle. Do not use any other valve caps or systems, e.g. tire pressure monitoring systems.

Regularly check the pressure of all the tires particularly prior to long trips. Adjust the tire pressure as necessary (> page 295).

The service life of tires depends, among other things, on the following factors:

- Driving style
- Tire pressure
- Distance covered

Tire tread

WARNING

Insufficient tire tread will reduce tire traction. The tire is no longer able to dissipate water. This means that on wet road surfaces, the risk of hydroplaning increases, in particular where speed is not adapted to suit the driving conditions. There is a risk of accident.

If the tire pressure is too high or too low, tires may exhibit different levels of wear at different locations on the tire tread. Thus, you should regularly check the tread depth and the condition of the tread across the entire width of all tires.

Minimum tire tread depth for:

- Summer tires: $\frac{1}{8}$ in (3 mm)
- M+S tires: $\frac{1}{6}$ in (4 mm)

For safety reasons, replace the tires before the legally prescribed limit for the minimum tire tread depth is reached.

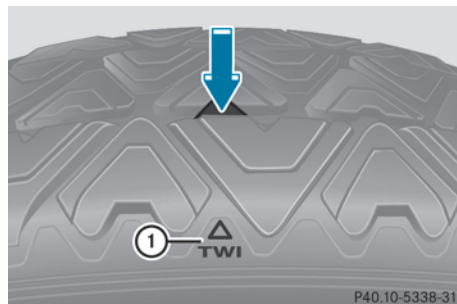

Bar indicator ① for tread wear is integrated into the tire tread.

Tread wear indicators (TWI) are required by law. Six indicators are positioned on the tire tread. They are visible once the tread depth is approximately $\frac{1}{16}$ in (1.6 mm). If this is the case, the tire is so worn that it must be replaced.

Selecting, mounting and replacing tires

- Only mount tires and wheels of the same type and make.
- Only mount tires of the correct size onto the wheels.
- After mounting new tires, break them in at moderate speeds for the first 60 miles (100 km), as they only reach their full performance after this distance.
- Do not drive with tires which have too little tread depth. as this significantly reduces the traction on wet roads (hydroplaning).
- Replace the tires after six years at the latest, regardless of wear.

MOExtended tires (tires with run-flat properties)

With MOExtended tires (tires with run flat characteristics), you can continue to drive your vehicle even if there is a total loss of pressure in one or more tires.

MOExtended tires may only be used in conjunction with an active tire pressure loss warning system and only on wheels specifically tested by Mercedes-Benz.

Notes on driving with MOExtended tires with a flat tire (▷ page 275).

- ❗ Vehicles equipped with MOExtended tires are not equipped with a TIREFIT kit at the factory. It is therefore recommended that you additionally equip your vehicle with a TIREFIT kit if you mount tires that do not feature run-flat properties, e.g. winter tires. A TIREFIT kit can be obtained from a qualified specialist workshop.

Winter operation

General notes

Have your vehicle winterproofed at a qualified specialist workshop at the onset of winter.

Observe the notes in the "Changing a wheel" section (▷ page 312).

Driving with summer tires

At temperatures below 45 °F (+7 °C), summer tires lose elasticity and therefore traction and braking power. Change the tires on your vehicle to M+S tires. Using summer tires at very cold temperatures could cause cracks to form, thereby damaging the tires permanently. Mercedes-Benz cannot accept responsibility for this type of damage.

M+S tires

WARNING

M+S tires with a tire tread depth of less than 1/8 in (4 mm) are not suitable for use in winter and do not provide sufficient traction. There is a risk of an accident.

M+S tires with a tread depth of less than 1/8 in (4 mm) must be replaced immediately.

At temperatures below 45 °F (+7 °C), use winter tires or all-season tires. Both types of tire are identified by the M+S marking.

Only winter tires bearing the  snowflake symbol in addition to the M+S marking provide the best possible grip in wintry road conditions. Only these tires will allow driving safety systems such as ABS and ESP® to function optimally in winter. These tires have been developed specifically for driving in snow.

Use M+S tires of the same make and tread on all wheels to maintain safe handling characteristics.

Always observe the maximum permissible speed specified for the M+S tires you have mounted.

Once the winter tires are mounted:

- ▶ Check the tire pressures (▷ page 298).
- ▶ Restart the tire pressure loss warning system (▷ page 298).

For more information on driving with the emergency spare wheel, see (▷ page 318).

Snow chains

WARNING

If snow chains are mounted on the rear wheels, the snow chains could cause abrasion to the vehicle body or to chassis components. This could cause damage to the vehicle or the tires. There is a risk of an accident.

To avoid hazardous situations:

- never mount snow chains on the rear wheels
- only mount snow chains in pairs on the front wheels.

! On some tire sizes there is not enough space for snow chains. To avoid damage to the vehicle or tires, observe the "Wheel and tire combinations" section under "Tires and wheels".

For safety reasons, Mercedes-Benz recommends that you only use snow chains that have been specially approved for your vehicle by Mercedes-Benz, or are of a corresponding standard of quality.

If you intend to mount snow chains, please bear the following points in mind:

- Snow chains may not be mounted on all wheel/tire combinations. Permissible wheel-tire combinations (▷ page 316).
- Only use snow chains when driving on roads completely covered by snow. Remove the snow chains as soon as possible when you come to a road that is not snow-covered.
- Local regulations may restrict the use of snow chains. Observe the appropriate regulations if you wish to mount snow chains.
- Do not exceed the maximum permissible speed of 30 mph (50 km/h).
- If snow chains are mounted, you cannot use Active Parking Assist (▷ page 164).

- i** You can deactivate ESP® (▷ page 63) when pulling away with snow chains installed. This way you can allow the wheels to spin in a controlled manner, achieving an increased driving force (cutting action).

For more information on driving with the emergency spare wheel, see (▷ page 318).

Tire pressure

Tire pressure specifications

WARNING

Tires with tire pressures that are too low or too high are associated with the following hazards:

- they can burst, in particular if the vehicle is heavily laden or when driven at high speeds.
- the tires can wear excessively and/or unevenly, which can severely impair tire traction.
- the driving, steering and braking characteristics may be severely impaired.

There is a risk of accident.

Follow recommended tire inflation pressures and check the pressure of all the tires including the spare wheel:

- monthly, at least
- if the load changes
- before beginning a long journey
- under different operating conditions, e.g. off-road driving

If necessary, correct the tire pressure.

The recommended tire pressures for the tires mounted at the factory can be found on the labels described here.

Option 1) **Tire and Loading Information placard** on the B-pillar on the driver's side of the vehicle (▷ page 300).

The Tire and Loading Information placard contains the recommended tire pressures for cold tires. The recommended tire pressures

are valid for the maximum permissible load and up to the maximum permissible vehicle speed.

LOADING INFORMATION
RENGEIGNEMENT SUR LES PNEUS ET LE CHARGEMENT

SEATING CAPACITY / NOMBRE DE PLACES: TOTAL 7, FRONT AVANT 2, MIDDLE MILIEU 3, REAR ARRIERE 2

The combined weight of occupants and cargo should never exceed XXX kg or XXX lbs. Le poids total des occupants et du chargement ne doit jamais dépasser XXX kg ou XXX lbs.

TIRE PNEU	SIZE DIMENSIONS	COLD TIRE PRESSURE PRESSION DES PNEUS À FROID	SEE OWNER'S MANUAL FOR ADDITIONAL INFORMATION
FRONT AVANT	255/40 ZR18 99Y XL	200 kPa, 29 PSI	VOIR LE MANUEL DE L'USAGER POUR PLUS DE RENSEIGNEMENTS
REAR ARRIERE	285/35 ZR18 101Y XL	200 kPa, 29 PSI	
SPIRE DE SECOURS	175/55-18 95P	420 kPa, 60 PSI	

P40.00-2205-31

① Recommended tire pressures

Option 2) **Tire pressure table** on the inside of the fuel filler flap.

The tire pressure table contains the recommended pressures for cold tires for various operating conditions, i.e. differing load and speed conditions.

❗ Specifications shown in the examples of tire pressure tables are for illustration purposes only. Tire pressure specifications are vehicle-specific and may deviate from the data shown here. Tire pressure specifications applicable to your vehicle are located in your vehicle's tire pressure table.

COLD TIRE PRESSURE

normal load: [] [] [] []
maximum load: [] [] [] []

Warm tires up to: + 4 psi

P40.00-2179-31

Example: tire pressure table for all tires permitted for this vehicle by the factory

If a tire size precedes a tire pressure, the tire pressure information following is only valid for that tire size. The load conditions "partially laden" and "fully laden" are defined in the

table for different numbers of occupants and amounts of luggage. The actual number of seats may differ.

LUFTRUCK PRESSURE PRESSION PRESSION
für kalte Reifen for cold tires des pneus froids de inflado

100 kPa = 1 bar

Tire Size	1 Occupant	2 Occupants	3 Occupants	4 Occupants
195/55 R16	[] [] [] []	[] [] [] []	[] [] [] []	[] [] [] []
215/45 R17	[] [] [] []	[] [] [] []	[] [] [] []	[] [] [] []
215/40 R18	[] [] [] []	[] [] [] []	[] [] [] []	[] [] [] []

Warme Reifen: Warm tires up to: + 30 kPa + 4 psi
Pneus chauffés jusqu'à: Neumáticos calientes hasta:

P40.00-2183-31

Example: tire pressure table with tire dimensions

Some tire pressure tables show only the rim diameters instead of the full tire size, e.g.

R18. The rim diameter is part of the tire size and can be found on the tire sidewall (▷ page 306).

Lufdruck für kalte Reifen The pressure cold tires Pression des pneus froids Pression de inflado

100 kPa = 1 bar

Rim Diameter	1 Occupant	2 Occupants	3 Occupants	4 Occupants
R18	[] [] [] []	[] [] [] []	[] [] [] []	[] [] [] []
R19	[] [] [] []	[] [] [] []	[] [] [] []	[] [] [] []

bis up to 240 km/h Winterreifen: Winter tires Pression hiver Neumáticos de invierno: Pneus chauffés jusqu'à: Neumáticos calientes hasta: + 30 kPa + 4 psi
hasta 150 mph

P40.00-2184-31

If the tire pressures have been set to the lower values for lighter loads and/or lower road speeds, the pressures should be reset to the higher values:

- if you want to drive with an increased load and/or
- if you want to drive at higher road speeds

❗ The tire pressures for increased loads and/or higher road speeds, shown in the tire pressure table, may have a negative effect on driving comfort.

If the tire pressure is not set correctly, this can lead to an excessive build up of heat and a sudden loss of pressure.

For more information, contact a qualified specialist workshop.

Important notes on tire pressure

WARNING

If the tire pressure drops repeatedly, the wheel, valve or tire may be damaged. Tire pressure that is too low may result in a tire blow-out. There is a risk of an accident.

- Check the tire for foreign objects.
- Check whether the wheel is losing air or the valve is leaking.

If you are unable to rectify the damage, contact a qualified specialist workshop.

WARNING

If you fit unsuitable accessories onto tire valves, the tire valves may be overloaded and malfunction, which can cause tire pressure loss. Due to their design, retrofitted tire pressure monitors keep the tire valve open. This can also result in tire pressure loss. There is a risk of an accident.

Only screw the standard valve cap or other valve caps approved by Mercedes-Benz for your vehicle onto the tire valve.

Use a suitable pressure gauge to check the tire pressure. The outer appearance of a tire does not permit any reliable conclusion about the tire pressure.

The tire temperature and pressure increase when the vehicle is in motion. This is dependent on the driving speed and the load. Therefore, you should only correct tire pressures when the tires are cold.

The tires are cold:

- if the vehicle has been parked without direct sunlight on the tires for at least three hours and
- if the vehicle has not been driven further than 1 mile (1.6 km)

The tire temperature changes depending on the outside temperature, the vehicle speed

and the tire load. If the tire temperature changes by 18 °F (10 °C), the tire pressure changes by approximately 10 kPa (0.1 bar/ 1.5 psi). Take this into account when checking the pressure of warm tires. Only correct the tire pressure if it is too low for the current operating conditions. If you check the tire pressure when the tires are warm, the resulting value will be higher than if the tires were cold. This is normal. Do not reduce the tire pressure to the value specified for cold tires. The tire pressure would otherwise be too low.

Observe the recommended tire pressures for cold tires:

- on the Tire and Loading Information placard on the B-pillar on the driver's side
- in the tire pressure table on the inside of the fuel filler flap

Underinflated or overinflated tires

Underinflation

WARNING

Tires with pressure that is too low can overheat and burst as a consequence. In addition, they also suffer from excessive and/or irregular wear, which can severely impair the braking properties and the driving characteristics. There is a risk of an accident. Avoid tire pressures that are too low in all the tires, including the spare wheel.

Underinflated tires may:

- wear quickly and unevenly
- have an adverse effect on fuel consumption
- overheat, leading to tire defects
- have an adverse effect on handling characteristics

Overinflation

WARNING

Tires with excessively high pressure can burst because they are damaged more easily by road debris, potholes etc. In addition, they also suffer from irregular wear, which can severely impair the braking properties and the driving characteristics. There is a risk of an accident.

Avoid tire pressures that are too high in all the tires, including the spare wheel.

Overinflated tires may:

- have an adverse effect on handling characteristics
- wear quickly and unevenly
- be more susceptible to damage
- have an adverse effect on ride comfort
- increase the braking distance

Maximum tire pressures

Never exceed the maximum permissible tire inflation pressure. Always observe the recommended tire pressure for your vehicle when adjusting the tire pressure (> page 295).

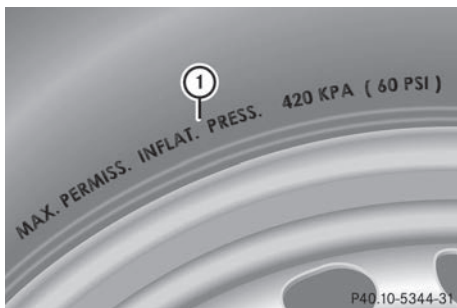

- ① Example: maximum permissible tire pressure
-  The actual values for tires are vehicle-specific and may deviate from the values in the illustration.

Checking the tire pressures

Important safety notes

Observe the "Tire pressure information" section (> page 295).

Information on air pressure for the tires on your vehicle can be found:

- on the vehicle's Tire and Loading Information placard on the B-pillar
- on the tire pressure label on the fuel filler flap
- in the "Tire pressure information" section

Checking tire pressures manually

To determine and set the correct tire pressure, proceed as follows:

- ▶ Remove the valve cap of the tire that is to be checked.
- ▶ Press the tire pressure gauge securely onto the valve.
- ▶ Read the tire pressure and compare it with the recommended value on the Tire and Loading Information placard on the B-pillar on the driver's side of your vehicle.
- ▶ If necessary, increase the tire pressure to the recommended value (> page 295).
- ▶ If the tire pressure is too high, release air by pressing down the metal pin in the valve using the tip of a pen, for example. Then, check the tire pressure again using the tire pressure gauge.
- ▶ Screw the valve cap onto the valve.
- ▶ Repeat these steps for the other tires.

Tire pressure loss warning system

Important safety notes

While the vehicle is in motion, the tire pressure loss warning system monitors the set tire pressure using the rotational speed of the wheels. This enables the system to detect significant pressure loss in a tire. If the speed of rotation of a wheel changes as a result of

a loss of pressure, a corresponding warning message will appear in the multifunction display.

The tire pressure warning system does not warn you of an incorrectly set tire pressure. Observe the notes on the recommended tire pressure (▷ page 295).

The tire pressure loss warning system does not replace the need to regularly check your vehicle's tire pressures, since an even loss of pressure on several tires at the same time cannot be detected by the tire pressure loss warning system.

The tire pressure loss warning system is not able to warn you of a sudden loss of pressure, e.g. if the tire is penetrated by a foreign object. In the event of a sudden loss of pressure, bring the vehicle to a halt by braking carefully. Avoid abrupt steering maneuvers.

The function of the tire pressure loss warning system is limited or delayed if:





- snow chains are mounted to your vehicle's tires.
- road conditions are wintry.
- you are driving on sand or gravel.
- you adopt a very sporty driving style (cornering at high speeds or driving with high rates of acceleration).
- you are driving with a heavy load (in the vehicle or on the roof).

Restarting the tire pressure loss warning system





Restart the tire pressure loss warning system if you have:

- changed the tire pressure
- changed the wheels or tires
- mounted new wheels or tires
- ▶ Before restarting, make sure that the tire pressures are set properly on all four tires for the respective operating conditions. The recommended tire pressures can be found in the table on the fuel filler flap.

The tire pressure loss warning system can only give reliable warnings if you have set the correct tire pressure. If an incorrect tire pressure is set, these incorrect values will be monitored.





- ▶ Observe the notes on tire pressure (▷ page 295).
- ▶ Make sure that the SmartKey is in position **2** (▷ page 127) in the ignition lock.
- ▶ Press  or  on the steering wheel to select the **Service** menu.
- ▶ Press the  or  button to select **Tire Pressure**.
- ▶ Press the  button. The **Run Flat Indicator Active Press 'OK' to Restart** message appears in the multifunction display.

If you wish to confirm the restart:

- ▶ Press the  button. The **Tire Pressure Now OK?** message appears in the multifunction display.
- ▶ Press the  or  button to select **Yes**.
- ▶ Press the  button. The **Run Flat Indicator Restarted** message appears in the multifunction display. After a teach-in period, the tire pressure loss warning system will monitor the set tire pressures of all four tires.

or

If you wish to cancel the restart:

- ▶ Press the  button.
- or
- ▶ If the **Tire Pressure Now OK?** message appears, use the  or  button to select **Cancel**.
- ▶ Press the  button. The tire pressure values stored at the last restart will continue to be monitored.

Loading the vehicle

Instruction labels for tires and loads

WARNING

Overloaded tires can overheat, causing a blowout. Overloaded tires can also impair the steering and driving characteristics and lead to brake failure. There is a risk of accident.

Observe the load rating of the tires. The load rating must be at least half of the GAWR of your vehicle. Never overload the tires by exceeding the maximum load.



① B-pillar, driver's side

Two instruction labels on your vehicle show the maximum possible load.

- (1) The Tire and Loading Information placard is on the B-pillar on the driver's side. The Tire and Loading Information placard shows the maximum permissible number of occupants and the maximum permissible vehicle load. It also contains details of the tire sizes and corresponding pressures for tires installed at the factory.
- (2) The vehicle identification plate is on the B-pillar on the driver's side. The vehicle identification plate informs you of the gross vehicle weight rating. It is made up of the vehicle weight, all vehicle occupants, the fuel and the cargo. You can also find information about the maximum gross axle weight rating on the front and rear axle.

The maximum gross axle weight rating is the maximum weight that can be carried by one axle (front or rear axle). Never exceed the maximum load or the maximum gross axle weight rating for the front or rear axle.

Maximum permissible gross vehicle weight rating

TIRE		LOADING INFORMATION	
RENSEIGNEMENTS SUR LES PNEUS ET LE CHARGEMENT			
TIRE PNEU	SIZE DIMENSIONS	COLD TIRE PRESSURE PRESSION DES PNEUS A FROID	SEE OWNER'S MANUAL FOR ADDITIONAL INFORMATION VOIR LE MANUEL DE L'USAGER POUR PLUS DE RENSEIGNEMENTS
FRONT AVANT	255/40 ZR 18 99F XL	200 KPA, 29 PSI	
REAR ARRIERE	285/35 ZR 18 101Y XL	200 KPA, 29 PSI	
Spare DE SECOURS	175/55-18 95P	420 KPA, 60 PSI	

P40.00-2206-31

- The Tire and Loading Information placard gives you details on maximum permissible gross vehicle weight rating ①: "The gross weight of occupants and luggage must never exceed XXX kilograms or XXX pounds."

The gross weight of all vehicle occupants, load, luggage and trailer load/noseweight (if applicable) must not exceed the specified value.

- ① The specifications shown on the Tire and Loading Information placard in the illustration are examples. The maximum permissible load is vehicle-specific and may deviate from the data shown here. The maximum permissible load that applies for your vehicle can be found on your vehicle's Tire and Loading Information placard.

Number of seats

1 LOADING INFORMATION
RENSEIGNEMENTS SUR LES PNEUS ET LE CHARGEMENT

SEATING CAPACITY / NOMBRE DE PLACES: TOTAL 7, FRONT AVANT 2, MIDDLE MILIEU 3, REAR ARRIERE 2

The combined weight of occupants and cargo should never exceed XXX kg or XXX lbs.
Le poids total des occupants et du chargement ne doit jamais dépasser XXX kg ou XXX lbs.

TIRE PNEU	SIZE DIMENSIONS	COLD TIRE PRESSURE / PRESSION DES PNEUS A FROID
FRONT AVANT	255/40 ZR18 99Y XL	200 KPA, 29 PSI
REAR ARRIERE	286/35 ZR18 101Y XL	200 KPA, 29 PSI
SPARE DE SECOURS	175/55-18 95P	420 KPA, 60 PSI

SEE OWNER'S MANUAL FOR ADDITIONAL INFORMATION
VOIR LE MANUEL DE L'USAGER POUR PLUS DE RENSEIGNEMENTS

P40.00-2207-31

Maximum number of seats **1** determines the maximum number of occupants allowed to travel in the vehicle. This information can be found on the Tire and Loading Information placard.

- i** The specifications shown on the Tire and Loading Information placard in the illustration are examples. The number of seats is vehicle-specific and can differ from the details shown. The number of seats in your vehicle can be found on the Tire and Loading Information placard.

Determining the correct load limit

Step-by-step instructions

The following steps have been developed as required of all manufacturers under Title 49, Code of U.S. Federal Regulations, Part 575 pursuant to the "National Traffic and Motor Vehicle Safety Act of 1966".

- ▶ **Step 1:** Locate the statement "The combined weight of occupants and cargo should never exceed XXX kg or XXX lbs." on your vehicle's Tire and Loading Information placard.
- ▶ **Step 2:** Determine the combined weight of the driver and passengers that will be riding in your vehicle.
- ▶ **Step 3:** Subtract the combined weight of the driver and passengers from XXX kilograms or XXX lbs.

- ▶ **Step 4:** The resulting figure equals the available amount of cargo and luggage load capacity. For example, if the "XXX" amount equals 1400 lbs and there are five occupants in the vehicle each with a weight of 150 lbs, the amount of available cargo and luggage load capacity is 650 lbs ($1400 - 750 (5 \times 150) = 650$ lbs).

- ▶ **Step 5:** Determine the combined weight of luggage and cargo being loaded on the vehicle. That weight may not safely exceed the available cargo and luggage load capacity calculated in step 4.

- ▶ **Step 6 (if applicable):** If your vehicle will be towing a trailer, load from your trailer will be transferred to your vehicle. Consult this manual to determine how this reduces the available cargo and luggage load capacity of your vehicle (▷ page 303).

Example: steps 1 to 3

The following table shows examples on how to calculate total and cargo load capacities with varying seating configurations and number and size of occupants. The following examples use a load limit of 1500 lbs (680 kg). **This is for illustration purposes only.** Make sure you are using the actual load limit for your vehicle stated on your vehicle's Tire and Loading Information placard (▷ page 301).

The higher the weight of all the occupants, the smaller the maximum load for luggage.

		Example 1	Example 2	Example 3
Step 1	Combined maximum weight of occupants and cargo (data from the Tire and Loading Information placard)	1500 lbs (680 kg)	1500 lbs (680 kg)	1500 lbs (680 kg)

		Example 1	Example 2	Example 3
Step 2	Number of people in the vehicle (driver and occupants)	5	3	1
	Distribution of the occupants	Front: 2 Rear: 3	Front: 1 Rear: 2	Front: 1
	Weight of the occupants	Occupant 1: 150 lbs (68 kg) Occupant 2: 180 lbs (82 kg) Occupant 3: 160 lbs (73 kg) Occupant 4: 140 lbs (63 kg) Occupant 5: 120 lbs (54 kg)	Occupant 1: 200 lbs (91 kg) Occupant 2: 190 lbs (86 kg) Occupant 3: 150 lbs (68 kg)	Occupant 1: 150 lbs (68 kg)
	Gross weight of all occupants	750 lbs (340 kg)	540 lbs (245 kg)	150 lbs (68 kg)

		Example 1	Example 2	Example 3
Step 3	Permissible load and trailer load/noseweight (maximum permissible load rating from the Tire and Loading Information placard minus the gross weight of all occupants)	1500 lbs (680 kg) -750 lbs (340 kg) = 750 lbs (340 kg)	1500 lbs (680 kg) -540 lbs (245 kg) = 960 lbs (435 kg)	1500 lbs (680 kg) -150 lbs (68 kg) = 1350 lbs (612 kg)

Vehicle identification plate

Even if you have calculated the total load carefully, you should still make sure that the gross vehicle weight rating and the gross axle weight rating are not exceeded. Details can be found on the vehicle identification plate on the B-pillar on the driver's side of the vehicle (▷ page 300).

Permissible gross vehicle weight: the gross weight of the vehicle, all passengers, load and trailer load/noseweight (if applicable) must not exceed the permissible gross vehicle weight.

Gross axle weight rating: the maximum permissible weight that can be carried by one axle (front or rear axle).

To ensure that your vehicle does not exceed the maximum permissible values (gross vehicle weight and maximum gross axle weight rating), have your loaded vehicle (including driver, occupants, cargo, and full trailer load if applicable) weighed on a suitable vehicle weighbridge.

Trailer load/noseweight

The trailer load/noseweight affects the gross weight of the vehicle. If a trailer is attached, the trailer load/noseweight is included in the load along with occupants and luggage. The trailer load/noseweight is usually between

10% and 15% of the gross weight of the trailer and its load.

Maximum load rating

Do not overload the tires by exceeding the specified load limit. The maximum permissible load can be found on the vehicle's Tire and Loading Information placard on the B-pillar on the driver's side (▷ page 300).



Maximum tire load ① is the maximum permissible weight for which the tire is approved.

i The actual values for tires are vehicle-specific and may deviate from the values in the illustration.

Uniform Tire Quality Grading Standards

Overview of Tire Quality Grading Standards

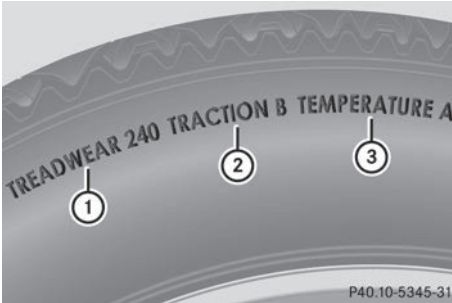

Uniform Tire Quality Grading Standards are U.S. government specifications. Their purpose is to provide drivers with uniform reliable information on tire performance data. Tire manufacturers have to grade tires using three performance factors: tread wear ①, tire traction ②, and heat resistance ③. These regulations do not apply to Canada. Nevertheless, all tires sold in North America are provided with the corresponding quality grading markings on the sidewall of the tire. All passenger car tires must conform to the statutory safety requirements in addition to these grades.

Where applicable, the tire grading information can be found on the tire sidewall between the tread shoulder and maximum tire width.

i The actual values for tires are vehicle-specific and may deviate from the values in the illustration.

For example:

Treadwear	Traction	Temperature
200	AA	A

Treadwear

The treadwear grade is a comparative rating based on the wear rate of the tire when tested under controlled conditions on a specified U.S. government course. For example, a tire graded 150 would wear one and one-half times as well on the government course as a tire graded 100.

The relative performance of tires depends upon the actual conditions of their use, however, and may depart significantly from the norm, due to variations in driving habits, service practices and differences in road characteristics and climate conditions.

Traction

⚠ WARNING

The traction grade assigned to this tire is based on straight-ahead braking traction tests, and does not include acceleration, cornering, hydroplaning, or peak traction characteristics.

The traction grades, from highest to lowest, are AA, A, B, and C. Those grades represent the tire's ability to stop on a wet surface as measured under controlled conditions on specified government test surfaces of asphalt and concrete. A tire marked C may have poor traction performance.

The safe speed on a wet, snow covered or icy road is always lower than on dry road surfaces.

You should pay special attention to road conditions when temperatures are around the freezing point.

Mercedes-Benz recommends a minimum tread depth of $\frac{1}{8}$ in (4 mm) for all four winter tires (> page 294) to maintain normal driving characteristics in winter. Winter tires can reduce the braking distance on snow-covered surfaces in comparison with summer tires. Stopping distance, however, is still considerably greater than when the road is

not covered with ice or snow. Take appropriate care when driving.

- ❗ Avoid wheelspin. This can lead to damage to the drive train.

Temperature

⚠ WARNING

The temperature grade for this tire is established for a tire that is properly inflated and not overloaded. Excessive speed, underinflation, or excessive loading, either separately or in combination, can cause excessive heat build-up and possible tire failure.

The temperature grades are A (the highest), B, and C. These represent the tire's resistance to the generation of heat and its ability to dissipate heat when tested under controlled conditions on a specified indoor laboratory test wheel. Sustained high temperature can cause the material of the tire to degenerate and reduce tire life, and excessive temperature can lead to sudden tire failure. The grade C corresponds to a level of performance which all passenger car tires must meet under the Federal Motor Vehicle Safety Standard No. 109. Grades B and A represent higher levels of performance on the laboratory test wheel than the minimum required by law.

Tire labeling

Tire labeling overview

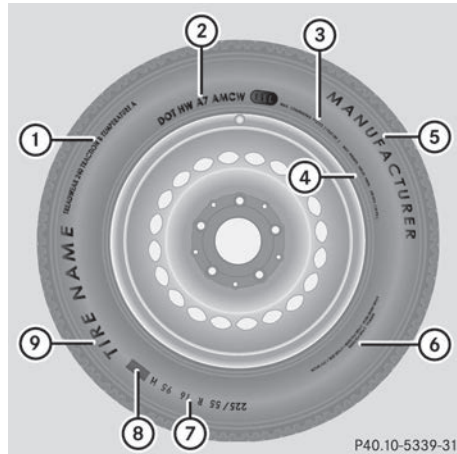

The following markings are on the tire in addition to the tire name (sales designation) and the manufacturer's name:

- ① Uniform tire Quality Grading Standard (▷ page 309)
 - ② DOT, Tire Identification Number (▷ page 308)
 - ③ Maximum tire load (▷ page 303)
 - ④ Maximum tire pressure (▷ page 298)
 - ⑤ Manufacturer
 - ⑥ Tire material (▷ page 309)
 - ⑦ Tire size designation, load-bearing capacity and speed index (▷ page 306)
 - ⑧ Load index (▷ page 308)
 - ⑨ Tire name
- ❗ Tire data is vehicle-specific and may deviate from the data in the example.

Tire size designation, load-bearing capacity and speed rating

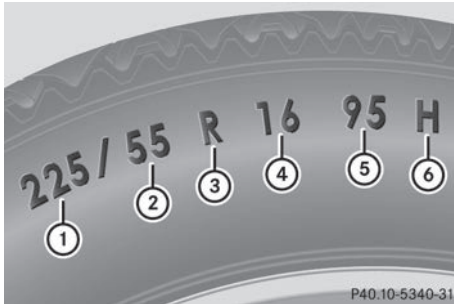

- ① Tire width
- ② Nominal aspect ratio in %
- ③ Tire code
- ④ Rim diameter
- ⑤ Load bearing index
- ⑥ Speed rating

i Tire data is vehicle-specific and may deviate from the data in the example.

General: depending on the manufacturer's standards, the size imprinted in the tire wall may not contain any letters or may contain one letter that precedes the size description.

If there is no letter preceding the size description (as shown above): these are passenger vehicle tires according to European manufacturing standards.

If "P" precedes the size description: these are passenger vehicle tires according to U.S. manufacturing standards.

If "LT" precedes the size description: these are light truck tires according to U.S. manufacturing standards.

If "T" precedes the size description: these are compact emergency spare wheels at high tire pressure, to be used only temporarily in an emergency.

Tire width: tire width ① shows the nominal tire width in millimeters.

Nominal aspect ratio: aspect ratio ② is the size ratio between the tire height and the tire width and is shown in percent. The aspect

ratio is calculated by dividing the tire width by the tire height.

Tire code: tire code ③ specifies the tire type. "R" represents radial tires; "D" represents diagonal tires; "B" represents diagonal radial tires.

Optionally, tires with a maximum speed of over 149mph (240km/h) may have "ZR" in the size description, depending on the manufacturer (e.g. 245/40 ZR 18).

Rim diameter: rim diameter ④ is the diameter of the bead seat, not the diameter of the rim flange. The rim diameter is specified in inches (in).

Load bearing index: load bearing index ⑤ is a numerical code which specifies the maximum load-bearing capacity of a tire.

Do not overload the tires by exceeding the specified load limit. The maximum permissible load can be found on the vehicle's Tire and Loading Information placard on the B-pillar on the driver's side ([▷ page 300](#)).

Example:

A load-bearing index of 91 indicates a maximum load of 1,356lb (615kg) that can be carried by the tires. For further information on the maximum tire load in kilograms and pounds, see ([▷ page 303](#)).

For further information on the load-bearing index, see Load index ([▷ page 308](#)).

Speed rating: speed rating ⑥ specifies the approved maximum speed of the tire.

⚠ WARNING



Exceeding the stated tire load-bearing capacity and the approved maximum speed could lead to tire damage or the tire bursting. There is a risk of accident.

Therefore, only use tire types and sizes approved for your vehicle model. Observe the tire load rating and speed rating required for your vehicle.

Regardless of the speed rating, always observe the speed limits. Drive carefully and



adapt your driving style to the traffic conditions.

Summer tires	
Index	Speed rating
Q	up to 100mph (160 km/h)
R	up to 106mph (170 km/h)
S	up to 112mph (180 km/h)
T	up to 118mph (190 km/h)
H	up to 130mph (210 km/h)
V	up to 149mph (240 km/h)
W	up to 168mph (270 km/h)
Y	up to 186mph (300 km/h)
ZR...Y	up to 186mph (300 km/h)
ZR...(..Y)	over 186mph (300 km/h)
ZR	over 149mph (240 km/h)

- Optionally, tires with a maximum speed of over 149 mph (240km/h) may have "ZR" in the size description, depending on the manufacturer (e.g. 245/40 ZR 18). The service specifications consist of load bearing index  and speed rating .
- If the size description of your tire includes "ZR" and there are no service specifications, ask the tire manufacturer in order to find out the maximum speed. If a service specification is available, the maximum speed is limited according to the speed rating in the service specification. Example: 245/40 ZR 18 97 Y. In this example, "97 Y" is the service specification. The letter "Y" represents the speed rating and the maximum speed of the tire is limited to 186 mph (300km/h).
- The size description for all tires with maximum speeds of over 186mph (300km/h) must include "ZR", **and** the

service specification must be given in brackets. Example: 275/40 ZR 18 (99 Y). The speed rating "(Y)" indicates that the maximum speed of the tire is over 186mph (300km/h). Ask the tire manufacturer about the maximum speed.

All-weather tires and winter tires	
Index	Speed rating
Q M+S ⁹	up to 100mph (160 km/h)
T M+S ⁹	up to 118mph (190 km/h)
H M+S ⁹	up to 130mph (210 km/h)
V M+S ⁹	up to 149mph (240 km/h)

-  Not all tires with the M+S marking provide the driving characteristics of winter tires. Winter tires have, in addition to the M+S identification, the  snowflake symbol on the tire sidewall. Tires with this marking fulfill the requirements of the Rubber Manufacturers Association (RMA) and the Rubber Association of Canada (RAC) regarding the tire traction on snow. They have been especially developed for driving on snow.

An electronic speed limiter prevents your vehicle from exceeding a speed of 130mph (210km/h).

The speed rating of tires mounted at the factory may be higher than the maximum speed that the electronic speed limiter permits.

Make sure that your tires have the required speed rating, e.g. when buying new tires. The required speed rating for your vehicle can be found in the "Tires" section (▷ page 316).

Further information about reading tire data can be obtained from any qualified specialist workshop.

⁹ Or M+S  for winter tires.

Load index



In addition to the load bearing index, load index ① may be imprinted after the letters that identify speed index ⑥ (> page 306) on the sidewall of the tire.

- If no specification is given: no text (as in the example above), represents a standard load (SL) tire
- XL or Extra Load: represents a reinforced tire
- Light Load: represents a light load tire
- C, D, E: represents a load range that depends on the maximum load that the tire can carry at a certain pressure

i Tire data is vehicle-specific and may deviate from the data in the example.

DOT, Tire Identification Number (TIN)

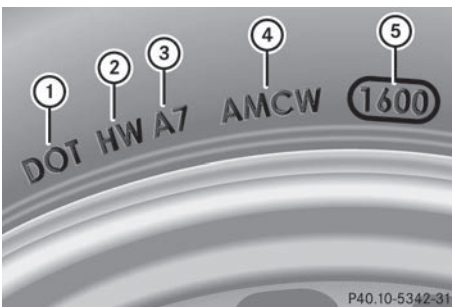

Canadian tire regulations prescribe that every new tire manufacturer or retreader has to imprint a TIN in or on the sidewall of each tire produced.

The TIN is a unique identification number. The TIN makes it easier for tire manufacturers or retreaders to notify customers of recalls or other safety-related matters. It makes it possible for the purchaser to easily identify the affected tires.

The TIN consists of the manufacturer identification code ②, tire size ③, tire type code ④ and manufacturing date ⑤.

DOT (Department of Transportation): tire symbol ① indicates that the tire complies with the requirements of the Canadian Transport Ministry.

Manufacturer identification code: manufacturer identification code ② provides details on the tire manufacturer. New tires have a code with two symbols. Retreaded tires have a code with four symbols.

Further information about retreaded tires (> page 292).

Tire size: identifier ③ describes the tire size.

Tire type code: tire type code ④ can be used by the manufacturer as a code to describe specific characteristics of the tire.

Date of manufacture: date of manufacture ⑤ provides information about the age of a tire. The first and second positions represent the week of manufacture, starting with "01" for the first calendar week. Positions three and four represent the year of manufacture. For example, a tire that is marked with "3208", was manufactured in week 32 in 2008.

i Tire data is vehicle-specific and may deviate from the data in the example.

Tire characteristics

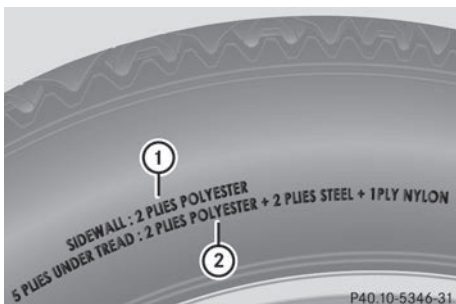

This information describes the tire cord and the number of layers in sidewall ① and under tire tread ②.

- i** Tire data is vehicle-specific and may deviate from the data in the example.

Definition of terms for tires and loading

Tire ply composition and material used

Describes the number of plies or the number of layers of rubber-coated fabric in the tire tread and sidewall. These are made of steel, nylon, polyester and other materials.

Bar

Metric unit for tire pressure.
14.5038 pounds per square inch (psi) and 100 kilopascals (kPa) are the equivalent of 1 bar.

DOT (Department of Transportation)

DOT marked tires fulfill the requirements of the Canadian Transport Ministry.

Normal occupant weight

The number of occupants for which the vehicle is designed multiplied by 68 kilograms (150 lb).

Uniform Tire Quality Grading Standards

A uniform standard to grade the quality of tires with regards to tread quality, tire traction and temperature characteristics. Ratings are determined by tire manufacturers using U.S. government testing procedures. The ratings are molded into the sidewall of the tire.

Recommended tire pressure

The recommended tire pressure applies to the tires mounted at the factory.

The Tire and Loading Information placard contains the recommended tire pressures for cold tires on a fully loaded vehicle and for the maximum permissible vehicle speed.

The tire pressure table contains the recommended pressures for cold tires for various operating conditions, i.e. differing load and speed conditions.

Increased vehicle weight due to optional equipment

This is the combined weight of all standard and optional equipment available for the vehicle, regardless of whether it is actually installed on the vehicle or not.

Rim

This is the part of the wheel on which the tire is mounted.

GAWR (Gross Axle Weight Rating)

The GAWR is the maximum gross axle weight rating. The actual load on an axle must never exceed the gross axle weight rating. The gross axle weight rating can be found on the vehicle identification plate on the B-pillar on the driver's side.

Speed rating

The speed rating is part of the tire identification. It specifies the speed range for which the tire is approved.

GVW (Gross Vehicle Weight)

The gross vehicle weight includes the weight of the vehicle including fuel, tools, the spare wheel, accessories installed, occupants, luggage and the drawbar noseweight, if applicable. The gross vehicle weight must not exceed the gross vehicle weight rating GVWR as specified on the vehicle identification plate on the B-pillar on the driver's side.

GVWR (Gross Vehicle Weight Rating)

The GVWR is the maximum permissible gross weight of a fully loaded vehicle (the weight of the vehicle including all accessories, occupants, fuel, luggage and the drawbar noseweight, if applicable). The gross vehicle weight rating is specified on the vehicle identification plate on the B-pillar on the driver's side.

Maximum loaded vehicle weight

The maximum weight is the sum of:

- the curb weight of the vehicle
- the weight of the accessories
- the load limit
- the weight of the factory installed optional equipment

Kilopascal (kPa)

Metric unit for tire pressure. 6.9 kPa corresponds to 1 psi. Another unit for tire pressure is bar. 100 kilopascal (kPa) is the equivalent of 1 bar.

Load index

In addition to the load-bearing index, the load index may also be imprinted on the sidewall of the tire. This specifies the load-bearing capacity more precisely.

Curb weight

The weight of a vehicle with standard equipment including the maximum capacity of fuel, oil and coolant. It also includes the air-conditioning system and optional equipment if these are installed in the vehicle, but does not include passengers or luggage.

Maximum load rating

The maximum load rating in kilograms or pounds is the maximum weight for which a tire is approved.

Maximum permissible tire pressure

Maximum permissible tire pressure for one tire.

Maximum load on one tire

Maximum load on one tire. This is calculated by dividing the maximum axle load of one axle by two.

PSI (pounds per square inch)

A standard unit of measure for tire pressure.

Aspect ratio

Relationship between tire height and tire width in percent.

tire pressure

This is pressure inside the tire applying an outward force to each square inch of the tire's surface. The tire pressure is specified in pounds per square inch (psi), in kilopascal (kPa) or in bar. The tire pressure should only be corrected when the tires are cold.

Tire pressure of cold tires

The tires are cold:

- if the vehicle has been parked without direct sunlight on the tires for at least three hours and
- if the vehicle has not been driven further than 1 mile (1.6 km)

Tread

The part of the tire that comes into contact with the road.

Bead

The tire bead ensures that the tire sits securely on the wheel. There are several steel wires in the bead to prevent the tire from coming loose from the wheel rim.

Sidewall

The part of the tire between the tread and the bead.

Weight of optional extras

The combined weight of those optional extras that weigh more than the replaced standard part and more than 2.3 kg (5 lbs). These

optional extras, such as high-performance brakes, level control, a roof rack or a high-performance battery, are not included in the curb weight and the weight of the accessories.

TIN (Tire Identification Number)

This is a unique identifier which can be used by a tire manufacturer to identify tires, for example for a product recall, and thus identify the purchasers. The TIN is made up of the manufacturer's identity code, tire size, tire type code and the manufacturing date.

Load bearing index

The load bearing index (also load index) is a code that contains the maximum load bearing capacity of a tire.

Traction

Traction is the result of friction between the tires and the road surface.

Treadwear indicators

Narrow bars (tread wear bars) that are distributed over the tire tread. If the tire tread is level with the bars, the wear limit of $\frac{1}{16}$ in (1.6 mm) has been reached.

Occupant distribution

The distribution of occupants in a vehicle at their designated seating positions.

Total load limit

Nominal load and luggage load plus 68 kilograms (150 lb) multiplied by the number of seats in the vehicle.

Changing a wheel

Flat tire

You can find information on what to do in the event of a flat tire in the "Flat tire" section (▷ page 275). You will also find information on driving with MOExtended tires in the event of a flat tire.

Vehicle with emergency spare wheel: in the event of a flat tire, the emergency spare wheel is mounted as described under "Mounting a wheel" (▷ page 312).

Interchanging the wheels

WARNING

Interchanging the front and rear wheels may severely impair the driving characteristics if the wheels or tires have different dimensions. The wheel brakes or suspension components may also be damaged. There is a risk of accident.

Rotate front and rear wheels only if the wheels and tires are of the same dimensions.

Always pay attention to the instructions and safety notes when changing a wheel (▷ page 312).

The wear patterns on the front and rear tires differ, depending on the operating conditions. Rotate the wheels before a clear wear pattern has formed on the tires. Front tires typically wear more on the shoulders and the rear tires in the center.

If your vehicle's tire configuration allows, you can rotate the wheels according to the intervals in the tire manufacturer's warranty book in your vehicle documents. If no warranty book is available, the tires should be interchanged every 3,000 to 6,000 miles (5,000 to 10,000 km), or earlier if tire wear requires. Do not change the direction of wheel rotation.

Clean the contact surfaces of the wheel and the brake disc thoroughly every time a wheel is interchanged. Check the tire pressure and,

if necessary, restart the tire pressure loss warning system.

Direction of rotation

Tires with a specified direction of rotation have additional benefits, e.g. if there is a risk of hydroplaning. You will only gain these benefits if the correct direction of rotation is maintained.

An arrow on the sidewall of the tire indicates its correct direction of rotation.

Storing wheels

Store wheels that are not being used in a cool, dry and preferably dark place. Protect the tires from oil, grease, gasoline and diesel.

Cleaning the wheels

WARNING

The water jet from a circular jet nozzle (dirt blasters) can cause invisible exterior damage to the tires or chassis components.

Components damaged in this way may fail unexpectedly. There is a risk of an accident.

Do not use power washers with circular jet nozzles to clean the vehicle. Have damaged tires or chassis components replaced immediately.

Mounting a wheel

Preparing the vehicle

- ▶ Park the vehicle on firm, non-slippery and level ground.
- ▶ Apply the electric parking brake manually (▷ page 142).
- ▶ Bring the front wheels into the straight-ahead position.
- ▶ Move the DIRECT SELECT lever to position **P**.

- ▶ Switch off the engine.
- ▶ Remove the SmartKey from the ignition lock.
- ▶ If included in the vehicle equipment, take the tire-change tool kit out of the vehicle.
- ▶ Secure the vehicle to prevent it from rolling away.

Securing the vehicle to prevent it from rolling away

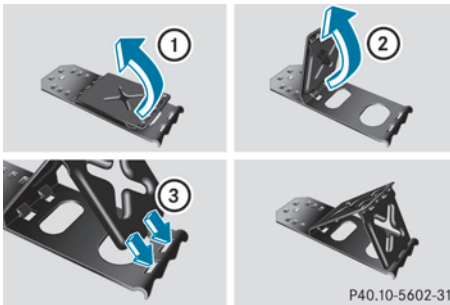

If your vehicle is equipped with a wheel chock, it can be found in the tire-change tool kit (▶ page 274).

The folding wheel chock is an additional securing measure to prevent the vehicle from rolling away, for example when changing a wheel.

- ▶ Fold both plates upwards ①.
- ▶ Fold out lower plate ②.
- ▶ Guide the lugs on the lower plate fully into the openings in base plate ③.

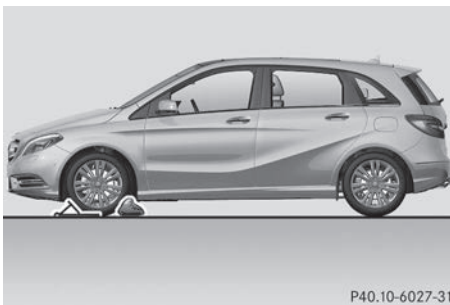

Securing the vehicle on level ground

- ▶ **On level ground:** place chocks or other suitable items under the front and rear of the wheel that is diagonally opposite the wheel you wish to change.

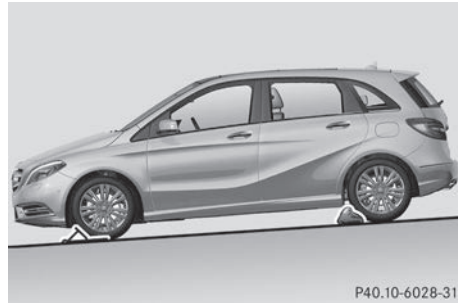

Securing the vehicle on slight downhill gradients

- ▶ **On slight downhill gradients:** place chocks or other suitable items in front of the wheels of the front and rear axle.

Raising the vehicle

WARNING

If you do not position the jack correctly at the appropriate jacking point of the vehicle, the jack could tip over with the vehicle raised. There is a risk of injury.

Only position the jack at the appropriate jacking point of the vehicle. The base of the jack must be positioned vertically, directly under the jacking point of the vehicle.

The following must be observed when raising the vehicle:

- to raise the vehicle, only use the vehicle-specific jack that has been tested and approved by Mercedes-Benz. If used incorrectly, the jack could tip over with the vehicle raised.
- the jack is designed only to raise and hold the vehicle for a short time while a wheel is being changed. It is not suited for performing maintenance work under the vehicle.
- avoid changing the wheel on uphill and downhill slopes.

- before raising the vehicle, secure it from rolling away by applying the parking brake and inserting wheel chocks. Never disengage the parking brake while the vehicle is raised.
- the jack must be placed on a firm, flat and non-slip surface. On a loose surface, a large, load-bearing underlay must be used. On a slippery surface, a non-slip underlay must be used, e.g. rubber mats.
- do not use wooden blocks or similar objects as a jack underlay. Otherwise, the jack will not be able to achieve its load-bearing capacity due to the restricted height.
- make sure that the distance between the underside of the tires and the ground does not exceed 1.2 inches (3 cm).
- never place your hands and feet under the raised vehicle.
- never lie under the raised vehicle.
- never start the engine when the vehicle is raised.
- never open or close a door or the tailgate when the vehicle is raised.
- make sure that no persons are present in the vehicle when the vehicle is raised.

❗ The jack is designed exclusively for jacking up the vehicle at the jacking points. Otherwise, your vehicle could be damaged.

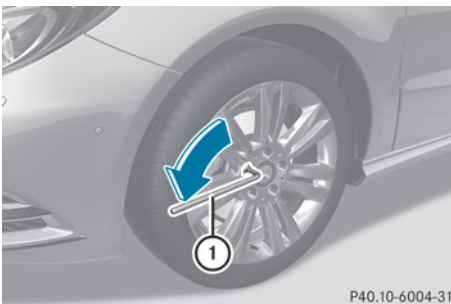

- Using lug wrench ①, loosen the bolts on the wheel you wish to change by about one full turn. Do not unscrew the bolts completely.

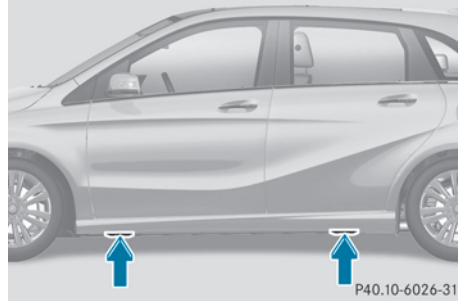

The jacking points are located just behind the wheel housings of the front wheels and just in front of the wheel housings of the rear wheels (arrows).

- Take the ratchet wrench out of the tire-changing tool kit and place it on the hexagon nut of the jack so that the letters **AUF** are visible.

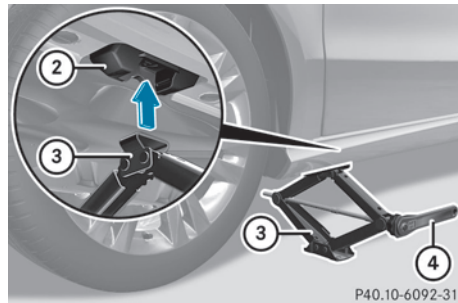

- Position jack ③ at jacking point ②.

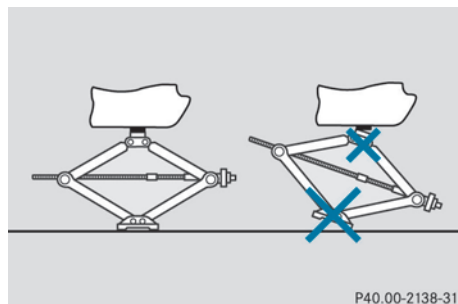

- Make sure the foot of the jack is directly beneath the jacking point.

- ▶ Turn ratchet wrench ④ until jack ③ sits completely on jacking point ② and the base of the jack lies evenly on the ground.
- ▶ Turn ratchet wrench ④ until the tire is raised a maximum of 1.2 in (3 cm) from the ground.

Removing a wheel

- ❗ Do not place wheel bolts in sand or on a dirty surface. The bolt and wheel hub threads could otherwise be damaged when you screw them in.
- ▶ Unscrew the wheel bolts.
- ▶ Remove the wheel.

Mounting a new wheel

⚠ WARNING
Oiled or greased wheel bolts or damaged wheel bolts/hub threads can cause the wheel bolts to come loose. As a result, you could lose a wheel while driving. There is a risk of accident.
Never oil or grease wheel bolts. In the event of damage to the threads, contact a qualified specialist workshop immediately. Have the damaged wheel bolts or hub threads replaced/renewed. Do not continue driving.

⚠ WARNING
If you tighten the wheel bolts or wheel nuts when the vehicle is raised, the jack could tip over. There is a risk of injury.
Only tighten the wheel bolts or wheel nuts when the vehicle is on the ground.

Always pay attention to the instructions and safety notes in the "Changing a wheel" section (▷ page 312).

Only use wheel bolts that have been designed for the wheel and the vehicle. For safety reasons, Mercedes-Benz recommends that you only use wheel bolts which have been approved for Mercedes-Benz vehicles and the respective wheel.

- ❗ To prevent damage to the paintwork, hold the wheel securely against the wheel hub while screwing in the first wheel bolt.

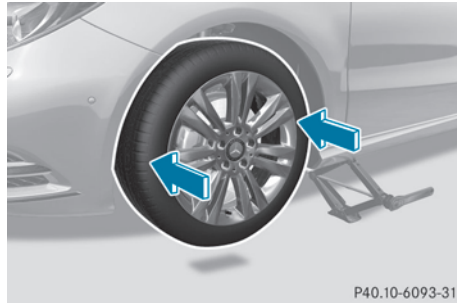

- ▶ Clean the wheel and wheel hub contact surfaces.
- ▶ Place the new wheel on the wheel hub and push it on.
- ▶ Tighten the wheel bolts until they are finger-tight.

Lowering the vehicle

⚠ WARNING
The wheels could work loose if the wheel nuts and bolts are not tightened to the specified tightening torque. There is a risk of accident.
Have the tightening torque immediately checked at a qualified specialist workshop after a wheel is changed.

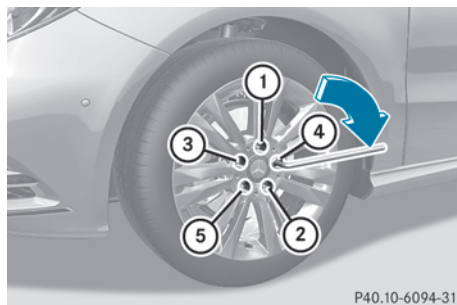

- ▶ Place the ratchet wrench onto the hexagon nut of the jack so that the letters **AB** are visible.
- ▶ Turn the ratchet wrench until the vehicle is once again standing firmly on the ground.
- ▶ Place the jack to one side.
- ▶ Tighten the wheel bolts evenly in a crosswise pattern in the sequence indicated (① to ⑤). The tightening torque must be **96 lb-ft (130 Nm)**.
- ▶ Turn the jack back to its initial position.
- ▶ Stow the jack and the rest of the vehicle tools in the vehicle again.
- ▶ Check the tire pressure of the newly installed wheel and adjust it if necessary. Observe the recommended tire pressure (▷ page 295).

Wheel and tire combinations

General notes

! For safety reasons, Mercedes-Benz recommends that you only use tires and wheels which have been approved by Mercedes-Benz specifically for your vehicle.

These tires have been specially adapted for use with the control systems, such as ABS or ESP®, and are marked as follows:

- MO = Mercedes-Benz Original
- MOE = Mercedes-Benz Original Extended (tires featuring run-flat characteristics)
- MO1 = Mercedes-Benz Original (only certain AMG tires)

Mercedes-Benz Original Extended tires may only be used on wheels that have been specifically approved by Mercedes-Benz.

Only use tires, wheels or accessories tested and approved by Mercedes-Benz. Certain characteristics, e.g. handling, vehicle noise emissions or fuel consumption, may otherwise be adversely affected. In addition, when driving with a

load, tire dimension variations could cause the tires to come into contact with the bodywork and axle components. This could result in damage to the tires or the vehicle. Mercedes-Benz accepts no liability for damage resulting from the use of tires, wheels or accessories other than those tested and approved.

Information on tires, wheels and approved combinations can be obtained from any qualified specialist workshop.

! Retreaded tires are neither tested nor recommended by Mercedes-Benz, since previous damage cannot always be detected on retreaded tires. As a result, Mercedes-Benz cannot guarantee vehicle safety if retreaded tires are mounted. Do not mount used tires if you have no information about their previous usage.

Overview of abbreviations used in the following tire tables:

- BA: both axles
- FA: front axle
- RA: rear axle

The recommended pressures for various operating conditions can be found:

- on the Tire and Loading Information placard with the recommended tire pressures on the B-pillar on the driver's side
- in the tire pressure table on the inside of the fuel filler flap

Observe the notes on recommended tire pressures under various operating conditions (▷ page 295).

Check tire pressures regularly, and only when the tires are cold. Comply with the maintenance recommendations of the tire manufacturer in the vehicle document wallet.

Notes on the vehicle equipment – always equip the vehicle with:

- tires of the same size on a given axle (left/right)
- the same type of tires at a given time (summer tires, winter tires, MOExtended tires)

Vehicles equipped with MOExtended tires are not equipped with a TIREFIT kit at the factory. It is therefore recommended that you additionally equip your vehicle with a TIREFIT kit if you mount tires that do not feature run-flat properties, e.g. winter tires. A TIREFIT kit may be obtained from a qualified specialist workshop.

i On the following pages, you can find information on approved wheel rims and tire sizes for equipping your vehicle with winter tires. Winter tires are not available at the factory as standard equipment or optional extras.

If you would like to equip your vehicle with approved winter tires, you may also, in certain circumstances, require rims of the appropriate size. The sizes of the approved winter tires may deviate from that of the standard tires. This is dependent on the model and the equipment installed at the factory.



The tires and wheel rims, as well as further information, can be obtained at a qualified specialist workshop.

In the following table, the wheel/tire combinations are assigned to the vehicle models through variants, e.g. V1, V2 etc.:

V1 B 250 ¹⁰

i Not all wheel and tire combinations are available at the factory for all countries.

¹⁰ BlueEFFICIENCY

Tires			
	Summer tires	Alloy wheels	V1
BA	225/40 R18 92 W XL MOExtended ^{11, 12}	7.5 J x 18 H2 Wheel offset: 2.05 in (52 mm)	•
	All-weather tires	Alloy wheels	V1
BA	225/45 R17 91 H M+SMOExtended ^{11, 12}	7.5 J x 17 H2 Wheel offset: 2.07 in (52.5 mm)	•
	Winter tires	Alloy wheels	V1
BA	205/50 R17 93 H XL M+S 	6.5 J x 17 H2 Wheel offset: 1.93 in (49 mm)	•
BA	205/50 R17 93 H XL M+S  MOExtended ¹²	6.5 J x 17 H2 Wheel offset: 1.93 in (49 mm)	•

Emergency spare wheel

Important safety notes

WARNING

The wheel or tire size as well as the tire type of the spare wheel or emergency spare wheel and the wheel to be replaced may differ. Mounting an emergency spare wheel may severely impair the driving characteristics. There is a risk of an accident.

To avoid hazardous situations:

- adapt your driving style accordingly and drive carefully.
- never install more than one spare wheel or emergency spare wheel that differs in size.
- only use a spare wheel or emergency spare wheel of a different size briefly.
- do not switch ESP[®] off.
- have a spare wheel or emergency spare wheel of a different size replaced at the nearest qualified specialist workshop.

Observe that the wheel and tire dimensions as well as the tire type must be correct.

When using an emergency spare wheel or spare wheel of a different size, you must not exceed the maximum speed of 80 km/h.

Snow chains must not be mounted on emergency spare wheels.

General notes

You should regularly check the pressure of the emergency spare wheel, particularly prior to long trips, and correct the pressure as necessary (▷ page 295). The value on the wheel or as given in the "Technical data" section (▷ page 316) is valid.

 When you are driving with the emergency spare wheel mounted, the tire pressure loss warning system cannot function reliably. Only restart the tire pressure loss

¹¹ Use of snow chains is not permitted. Observe the notes in the "Snow chains" section.

¹² MOExtended tires (tires with run-flat characteristics) only in conjunction with activated tire pressure loss warning.

warning system when the defective wheel has been replaced with a new wheel.

An emergency spare wheel may also be mounted against the direction of rotation. Observe the time restriction on use as well as the speed limitation specified on the emergency spare wheel.

Replace the tires after six years at the latest, regardless of wear. This also applies to the emergency spare wheel.

Removing the emergency spare wheel

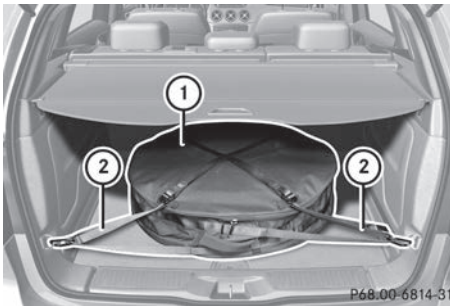

- ▶ Open the tailgate.
- ▶ Loosen lashing straps (2) on emergency spare wheel bag (1).
- ▶ Remove emergency spare wheel bag (1) with the "Minispare" emergency spare wheel.

For further information on changing and mounting a wheel, see (▷ page 312).

Technical data

"Minispare" emergency spare wheel

Tires

T 125/80 R17 99 M
Tire pressure: 420 kPa
(4.2 bar/61 psi)

Steel wheel

3.5 B x 17 H2
ET 19.5

Useful information	322
Information regarding technical data	322
Genuine Mercedes-Benz parts	322
Warranty	323
Identification plates	323
Service products and filling capacities	324
Vehicle data	329

Useful information

- i** This Operator's Manual describes all models and all standard and optional equipment of your vehicle available at the time of publication of the Operator's Manual. Country-specific differences are possible. Please note that your vehicle may not be equipped with all features described. This also applies to safety-related systems and functions.
- i** Please read the information on qualified specialist workshops (▷ page 23).

Information regarding technical data

- i** The data stated here specifically refers to a vehicle with standard equipment. Consult an authorized Mercedes-Benz Center for the data for all vehicle variants and trim levels.

Genuine Mercedes-Benz parts

WARNING

Driving safety may be impaired if non-approved parts, tires and wheels or safety-relevant accessories are used.

This could lead to malfunctions in safety-relevant systems, e.g. the brake system. This could cause you to lose control of your vehicle and cause an accident.

For this reason, Mercedes-Benz recommends that you use genuine Mercedes-Benz parts or parts of equal quality. Only use tires, wheels and accessories that have been specifically approved for your vehicle.

Environmental note

Daimler AG also supplies reconditioned major assemblies and parts which are of the same quality as new parts. They are covered by the same Limited Warranty entitlements as new parts.

- !** Air bags and Emergency Tensioning Devices, as well as control units and sensors for these restraint systems, may be installed in the following areas of your vehicle:

- doors
- door pillars
- door sills
- seats
- dashboard
- instrument cluster
- center console

Do not install accessories such as audio systems in these areas. Do not carry out repairs or welding. You could impair the operating efficiency of the restraint systems.

Have aftermarket accessories installed at a qualified specialist workshop. Mercedes-Benz recommends that you use an authorized Mercedes-Benz Center for this purpose.

Genuine Mercedes-Benz parts are subject to strict quality control. Each part has been specially developed, manufactured or selected for Mercedes-Benz vehicles and fine-tuned for them. Only genuine Mercedes-Benz parts should therefore be used.

More than 300,000 different genuine Mercedes-Benz parts are available for Mercedes-Benz models.

All Mercedes-Benz Centers maintain a supply of genuine Mercedes-Benz parts for necessary service and repair work. In addition, strategically located parts delivery centers provide quick and reliable parts service.

Always specify the vehicle identification number (VIN) (▷ page 323) and the engine number (▷ page 324) when ordering genuine Mercedes-Benz parts.

Warranty

The Service and Warranty Information booklet contains detailed information about the warranties covering your vehicle.

Your authorized Mercedes-Benz Center will exchange or repair any defective parts originally installed in the vehicle in accordance with the terms of the following warranties:

- New Vehicle Limited Warranty
- Emission System Warranty
- Emission Performance Warranty
- California, Connecticut, Maine, Massachusetts, New York, Pennsylvania, Rhode Island and Vermont Emission Control System Warranty
- State Warranty Enforcement Laws (Lemon Laws)

Replacement parts and accessories are covered by the Mercedes-Benz Parts and Accessories warranties. You can obtain information about this from any authorized Mercedes-Benz Center.

i Should you lose your Service and Warranty Information booklet, have an authorized Mercedes-Benz Center arrange for a replacement. It will be mailed to you.

Identification plates

Vehicle identification plate with vehicle identification number (VIN)

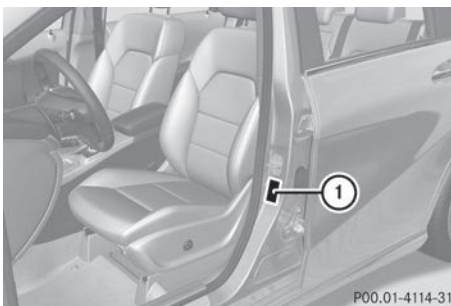

- ▶ Open the driver's door. You will see vehicle identification plate ①.

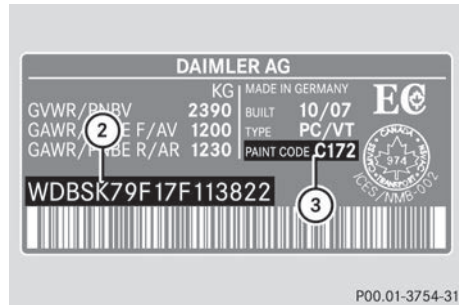

Vehicle identification plate (example)

- ② VIN
- ③ Paint code
- i** The data shown on the vehicle identification plate is used only as an example. This data is different for every vehicle and can deviate from the data shown here. You can find the data applicable to your vehicle on the vehicle's identification plate.

VIN

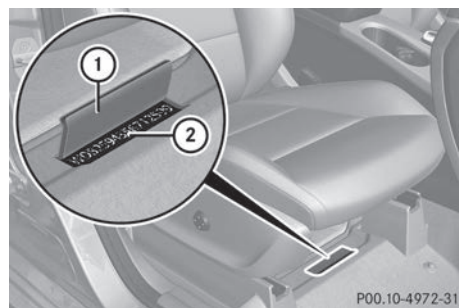

- ▶ Slide the right-hand front seat to its rearmost position.
- ▶ Fold up floor covering ① in front of the right-hand front seat. You will see VIN ②.

The VIN can also be found in the following locations:

- at the lower edge of the windshield (▷ page 324)
- on the vehicle identification plate (▷ page 323)

Engine number

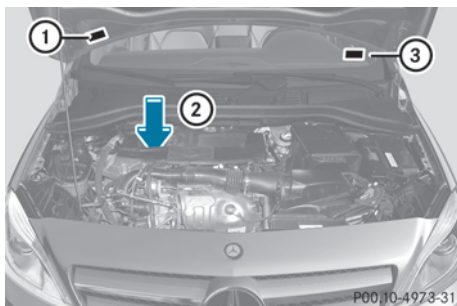

- ① Emission control information plate
- ② Engine number (stamped into the crankcase)
- ③ VIN (on the lower edge of the windshield)

Service products and filling capacities

Important safety notes

WARNING

Comply with all valid regulations with respect to handling, storing and disposing of service fluids. Otherwise, you could endanger persons or the environment.

Keep service fluids out of the reach of children.

For health reasons, you should prevent service fluids from coming into direct contact with your skin or clothing.

If a service fluid is swallowed, contact a physician immediately.

Environmental note

Dispose of service products in an environmentally responsible manner.

Service products include the following:

- fuels
- lubricants (e.g. engine oil, transmission oil)
- coolant
- brake fluid
- windshield washer fluid
- climate control system refrigerant

Components and service products must be matched. You should therefore only use products that have been tested and approved by Mercedes-Benz.

Information about tested and approved products can be obtained from an authorized Mercedes-Benz Center or on the Internet at <http://bevo.mercedes-benz.com>.

You can recognize service products approved by Mercedes-Benz by the following inscription on the containers:

- MB-Freigabe (e.g. MB-Freigabe 229.51)
- MB Approval (e.g. MB Approval 229.51)

Other designations or recommendations indicate a level of quality or a specification in accordance with an MB Sheet number (e.g. MB 229.5). They have not necessarily been approved by Mercedes-Benz.

Fuel

Important safety notes

WARNING

Fuel is highly flammable. If you handle fuel incorrectly, there is a risk of fire and explosion.

You must avoid fire, open flames, creating sparks and smoking. Switch off the engine and, if applicable, the auxiliary heating before refueling.

⚠ WARNING

Fuel is poisonous and hazardous to health. There is a risk of injury.

You must make sure that fuel does not come into contact with your skin, eyes or clothing and that it is not swallowed. Do not inhale fuel vapors. Keep fuel away from children.

If you or others come into contact with fuel, observe the following:

- Wash away fuel from skin immediately using soap and water.
- If fuel comes into contact with your eyes, immediately rinse them thoroughly with clean water. Seek medical assistance without delay.
- If fuel is swallowed, seek medical assistance without delay. Do not induce vomiting.
- Immediately change out of clothing which has come into contact with fuel.

Tank capacity

Model	Total capacity
B 250 BlueEFFICIENCY	13.2 US gal (50.0 l)

Model	Of which reserve
B 250 BlueEFFICIENCY	Approx. 1.6 US gal (6.0 l)

Gasoline**Fuel grade**

! Do not use diesel to refuel vehicles with a gasoline engine. Do not switch on the ignition if you accidentally refuel with the wrong fuel. Otherwise, the fuel will enter the fuel system. Even small amounts of the wrong fuel could result in damage to the fuel system and the engine. The repair

costs are high. Notify a qualified specialist workshop and have the fuel tank and fuel lines drained completely.

! You should only refuel with unleaded premium-grade gasoline as this avoids damaging the catalytic converter.

If engine running problems are apparent, have the cause checked immediately and repaired. Excess unburned fuel can otherwise enter the catalytic converter, leading to overheating and possibly causing a fire.

! To ensure the longevity and full performance of the engine, only premium-grade unleaded gasoline may be used. If there is no premium-grade unleaded gasoline available and regular unleaded gasoline must be used, please observe the following precautions:

- only fill the fuel tank to half full with regular unleaded gasoline and fill the rest with premium-grade unleaded gasoline as soon as possible.
- do not drive at the maximum speed.
- avoid sudden acceleration.
- if the vehicle is carrying a light load, e.g. two passengers without luggage, do not allow the engine to rev above 3000 rpm.
- if the vehicle is fully loaded or is being operated in mountainous terrain, do not depress the accelerator pedal further than $\frac{2}{3}$ of the pedal travel.

Only refuel using premium-grade unleaded gasoline with a minimum octane rating of 91. Reformulated Gasoline (RFG) and/or unleaded gasoline with additives can be used. The concentration of additives in the fuel, however, must not exceed 10%, e.g.:

- Ethanol
- TAME
- ETBE
- IPA
- TBA

For MTBE, the concentration should not exceed 15%.

The concentration of methanol in gasoline, including other additives, must not exceed 3%.

Using mixtures of methanol and ethanol is not permitted. Gasohol, a mixture of 10% ethanol and 90% unleaded gasoline, may be used.

All of these mix fuels must fulfill the fuel requirements, e.g.:

- knock resistance
- boiling point
- vapor pressure

You will usually find information about the fuel grade on the pump. If you cannot find the label on the pump, ask the staff for assistance.

- i** Please consult an authorized Mercedes-Benz Center for further information.

Information on refueling (▷ page 139).

Additives

- !** Operating the engine with fuel additives can increase wear and tear to the fuel system high-pressure pump and lead to contamination of the entire fuel system. The repair costs are high. This does not include additives for the removal and prevention of residue buildup. Gasoline must only be mixed with additives recommended by Mercedes-Benz. More information about recommended additives can be obtained from any authorized Mercedes-Benz Center.

One of the main problems of poor fuel quality is the forming of deposits that are created during the gasoline combustion process. Mercedes-Benz recommends that you use branded fuels that have additives.

If you use fuels without these additives over a longer period of time, carbon deposits may build up. These deposits form at the inlet valves and in the combustion chamber in particular.

This could lead to engine problems, e.g.:

- longer engine warm-up phase
- uneven idle
- engine noise
- misfiring
- loss of power

Carbon deposits may form if the availability of gasoline with relevant additives is insufficient (in certain regions). In this case, Mercedes-Benz recommends additives approved for use in Mercedes-Benz vehicles; see <http://bevo.mercedes-benz.com>.

For a list of approved products, consult an authorized Mercedes-Benz Center. Comply with the instructions for use on the product label.

Do not mix other fuel additives with fuel. This causes unnecessary costs and could damage the engine.

Engine oil

Points to note

- !** Never use engine oil or an oil filter of a specification other than is necessary to fulfill the prescribed service intervals. Do not change the engine oil or oil filter in order to achieve longer replacement intervals than those prescribed. You could otherwise cause engine damage or damage to the exhaust gas aftertreatment.

Follow the instructions in the service interval display regarding the oil change. Otherwise, you may damage the engine and the exhaust gas aftertreatment.

The engine oils are matched to the performance of Mercedes-Benz engines and service intervals. You should therefore only use engine oils and oil filters that are approved for vehicles with maintenance systems.

For a list of approved engine oils and oil filters, consult an authorized Mercedes-Benz

Center. Or visit the website <http://bevo.mercedes-benz.com>.

The table shows which engine oils have been approved for your vehicle.

Model	Engine model	MB Approval
B 250 BlueEFFICIENCY	270	229.5

- i** MB approval is indicated on the oil containers.

Filling capacities

The following values refer to an oil change including the oil filter.

Model	Capacity
B 250 BlueEFFICIENCY	5.9 US qt (5.6 l)

Additives

- !** Do not use any additives in the engine oil. This could damage the engine.

Engine oil viscosity

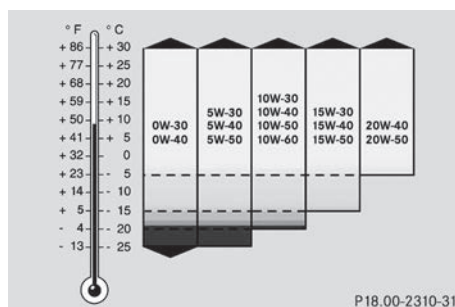

Viscosity describes the flow characteristics of a fluid. If an engine oil has a high viscosity, this means that it is thick; a low viscosity means that it is thin.

Select an engine oil with an SAE (viscosity) classification suitable for the prevailing outside temperatures. The table shows you which SAE classifications are to be used. The low-temperature characteristics of engine

oils can deteriorate significantly, e.g. as a result of aging, soot and fuel deposits. It is therefore strongly recommended that you carry out regular oil changes using an approved engine oil with the appropriate SAE classification.

Brake fluid

⚠ WARNING

Over a period of time, the brake fluid absorbs moisture from the air; this lowers its boiling point.

If the boiling point of the brake fluid is too low, vapor pockets may form in the brake system when the brakes are applied hard (e.g. when driving downhill). This would impair braking efficiency.

You should have the brake fluid renewed at regular intervals. The brake fluid change intervals can be found in the Maintenance Booklet.

Only use brake fluid approved by Mercedes-Benz according to MB Approval 331.0. Information about approved brake fluid can be obtained at any qualified specialist workshop or on the Internet at <http://bevo.mercedes-benz.com>.

- i** Have the brake fluid renewed regularly at a qualified specialist workshop.

Coolant

Important safety notes

⚠ WARNING

Antifreeze is highly flammable. Fire, open flames and smoking are prohibited when handling antifreeze.

If antifreeze comes into contact with hot engine parts, it may ignite and you could burn yourself. Do not spill any antifreeze on hot engine parts.

! Only add coolant that has been premixed with the desired antifreeze protection. You could otherwise damage the engine.

Further information on coolants can be found in the Mercedes-Benz Specifications for Service Products, MB Specifications for Service Products 310.1, e.g. on the Internet at <http://bevo.mercedes-benz.com>. Or contact a qualified specialist workshop.

! Always use a suitable coolant mixture, even in countries where high temperatures prevail.

Otherwise, the engine cooling system is not sufficiently protected from corrosion and overheating.

The coolant is a mixture of water and antifreeze/corrosion inhibitor. It performs the following tasks:

- corrosion protection
- antifreeze protection
- raising the boiling point

If the coolant has antifreeze protection down to -35 °F (-37 °C), the boiling point of the coolant during operation is approximately 266 °F (130 °C).

The antifreeze/corrosion inhibitor concentration in the engine cooling system should:

- be at least 50%. This will protect the engine cooling system against freezing down to approximately -35 °F (-37 °C).
- not exceed 55% (antifreeze protection down to -49 °F [-45 °C]). Otherwise, heat will not be dissipated as effectively.

The coolant is checked with every maintenance interval at a qualified specialist workshop.

i When the vehicle is first delivered, it is filled with a coolant mixture that ensures adequate antifreeze and corrosion protection.

Filling capacities

Model	Capacity
B 250 BlueEFFICIENCY	Approx. 8.2 US qt (7.8 l)

i Use antifreeze/corrosion inhibitor according to MB approval 325.0 or 326.0.

Windshield washer system and headlamp cleaning system

Important safety notes

WARNING

Windshield washer concentrate is highly flammable. If it comes into contact with hot engine components or the exhaust system it could ignite. There is a risk of fire and injury. Make sure that no windshield washer concentrate is spilled next to the filler neck.

! Only use washer fluid that is suitable for plastic lamp lenses, e.g. MB SummerFit or MB WinterFit. Unsuitable washer fluid could damage the plastic lenses of the headlamps.

! Do not add distilled or de-ionized water to the washer fluid container. Otherwise, the level sensor may be damaged.

! Only MB SummerFit and MB WinterFit washer fluid should be mixed together. The spray nozzles may otherwise become blocked.

At temperatures above freezing:

► Fill the washer fluid reservoir with a mixture of water and windshield washer fluid, e.g. MB SummerFit.

Add 1 part MB SummerFit to 100 parts water.

At temperatures below freezing:

- ▶ Fill the washer fluid reservoir with a mixture of water and windshield washer fluid, e.g. MB WinterFit.

Adapt the mixing ratio to the outside temperature.

- Down to 14 °F (-10 °C): mix 1 part MB WinterFit to 2 parts water.
- Down to -4 °F (-20 °C): mix 1 part MB WinterFit to 1 part water.
- Down to -20.2 °F (-29 °C): mix 2 parts MB WinterFit to 1 part water.

- ❗ Add windshield washer fluid, e.g. MB SummerFit or MB WinterFit, to the washer fluid all year round.

Filling capacities

Model	Capacity
B 250 BlueEFFICIENCY	3.2 US qt (3.0 l)

Vehicle data

General notes

Please note that for the specified vehicle data:

- the heights specified may vary as a result of:
 - Tires
 - Load
 - Condition of the suspension
 - Optional equipment

Dimensions and weights



Model	① Maximum headroom	② Opening height
B 250 BlueEFFICIENCY	73.8 in (1874 mm)	78.0 in (1981 mm)

B 250 BlueEFFICIENCY	
Vehicle length	171.6 in (4359 mm)
Vehicle width including exterior mirrors	79.1 in (2010 mm)
Vehicle height	61.3 in (1558 mm)
Wheelbase	106.3 in (2699 mm)
Turning radius	36.1 ft (11.0 m)
Maximum roof load	165 lb (75.0 kg)



2465840481

Order no. 6515 1712 13 Part no. 246 584 04 81 Edition B 2013